

Global Positioning System (GPS) Shield for Arduino™ and Raspberry-PI™

Technical Data

DS-GPM.S
Firmware version 1

Features

- **Arduino™ UNO Shield standard form factor for simple integration into any Arduino project.**
- **I²C interface for simple connection to Arduino or Raspberry-PI**
- **Give your robot the ability to know where it is, how fast its moving and in what direction*.**
- **Fast 56-channel position acquisition with battery back-up for fast < 1 second hot start and < 30 second warm start.**
- **Simple register based data retrieval of latitude, longitude, heading, altitude, speed, time, date & satellites in view.**
- **Integral low power antenna.**
- **Built in fully programmable 4 line IO and 8 bit ADC input port for local sensors.**

Description

The Designer Systems DS-GPM.S is a highly integrated Global Positioning System allowing your robotic application to determine its location on the earth's surface. Specifically targeted at the Arduino UNO board user [MEGA and NANO boards also supported] and the Raspberry-PI the GPM.S features I²C communication to leave the serial [TX/RX] port free for other functions eg. wireless communication.

GPS data received by the DS-GPM.S is stored within internal registers which are updated once per second and include:

- Latitude (i.e. vertical)
- Longitude (i.e. horizontal)
- Altitude (metres)
- Time & date (UTC)
- Heading (True & Magnetic)
- Speed (kilometres per hour)
- Satellites detected

In addition the DS-GPM.S features an on-board fully configurable four line programmable IO and analogue input port with automatic measurement.

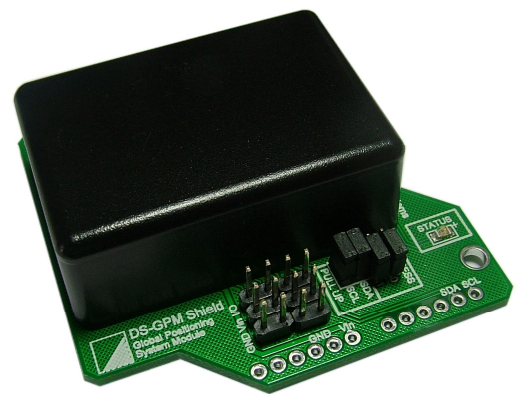

Applications

The DS-GPM.S has many applications in robotics, security and timing. For example the module could be used to send a rover to a particular position or be used to form a vehicle security solution in-conjunction with an embedded controller and GSM modem. Application notes for the UNO controller are provided.

Selection Guide

Description	Part Number
Global Position System Shield	DS-GPM.S

* Note: GPS information cannot be collected without a clear view of the sky.
Raspberry-PI, Arduino, UNO, NANO, UNO & MEGA are trademarks

GPS basics

The heart of the DS-GPM.S is a Global Positioning System receiver module and antenna that receive signals from satellites orbiting the earth.

There are 32 of these satellites, each sending its own unique signal to the earth's surface for pickup by any GPS receiver, which searches the sky for available satellites.

Upon detecting the satellites in view and their current position the receiver uses the satellites with highest signal strength to calculate, using triangulation, the receiver's latitude, longitude & altitude** (position).

Latitude is measured in degrees and minutes either North or South of the equator.

Longitude is measured in degrees and minutes either West or East of an imaginary line drawn vertically through Greenwich in the UK.

Altitude is measured in metres above sea level.

For example the offices of Designer Systems in Truro, UK are located 50 degrees, 15.817 minutes North latitude and 5 degrees, 3.549 minutes West longitude.

Should the receiver also be moving, speed in kilometres per hour, and heading, in degrees true north and magnetic north, can also be determined.

To gain the best reception the GPM should be used outside with a good view of the sky. Trees and buildings will cause the GPS signals being received to degrade and positional/speed information may be lost. To greatly improve reception the GPM should be mounted above a metal base.

** LLA format to WGS-84 ellipsoid.

Operation

When power is applied to the GPM the unit immediately starts to search for satellites. The GPM can start in one of three (3) modes, as follows:

Cold start mode:

This mode only applies when the GPM has been powered-up for the first time after being removed from its packaging. As the GPM does not know where it is on the earth's surface, it starts to hunt for groups of satellites to determine its location. This process may take up to 30 minutes before positional information is available; it is suggested that a battery be connected and the

unit left in the open air until the STATUS indicator starts to flash.

Warm start mode:

This mode applies to a GPM that has already been 'cold-started' and whose location has not changed significantly when powered up again or has been powered down for at least one (1) hour. Positional information is normally available again within 45 seconds of power re-application.

Hot start mode:

This mode applies when the GPM has been powered off for less than 60 minutes. Positional information is normally available again within 1-10 seconds of power re-application.

The warm and hot start power-up modes are possible due to an internal backup battery which powers the Real Time Clock (RTC) and almanac memory when external power is removed.

STATUS indication...

The STATUS indicator is used to provide visual feedback of the current GPM condition. There are three (3) conditions as follows:

ON Steady	Power applied and no positional information.
Flashing slowly	Positional information received.
Flashing fast	GPM in motion.

These conditions will change as the GPM moves around its location and under objects that may block the satellite signals.

Power requirements

The DS-GPM.S takes the power necessary for operation (approx. 30-90mA) from an external battery or power adaptor or power from the Arduino UNO board.

The GPM provides three PCB pads, two marked 'GND' and one marked 'Vin' in the same format as that present on the UNO board, which should be connected to negative and positive battery/power supply terminals respectively. The input voltage range is 7 - 16VDC with the internal circuitry being protected against power supply reversal.

IO port

The DS-GPM.S features a fully programmable four line CMOS input/output or 8bit Analogue to Digital Converter port 'I/O' '1' to '4'. Each IO is configurable as an output, an input or an analogue input by configuring the registers R0-3. When an IO is configured for a normal input the applied voltage 0 or 5V is read and stored in an input register which can be read by the connected I²C device. When an IO is configured as an output the output state will be 0 or 5V dependant on the output register contents written by the connected I²C device. When an IO is configured for analogue input** it is automatically updated every 100mS from an external input voltage of 0 - 5V and the result stored in internal registers which can be read by the connected I²C device (see register details further on in this datasheet). The port also incorporates a ground and Vin bus that allows sensors to be directly connected (see Fig. 3.0)

Warning: These inputs are not over-voltage protected and should not be subjected to voltages over 5V.

I²C connection

The I²C connections are marked 'SDA' and 'SCL' and allow connection to the Arduino UNO board 'ANALOG IN' pins 4 and 5 or the Raspberry-PI GPIO port pins 3 and 5 (see Fig. 2.0) or another I²C Master device.

The DS-GPM.S is fitted with pull-up jumpers that can be configured to provide the source current necessary for I²C communication. The following jumpers should normally be set when using the UNO board, as long as the I²C bus does not have existing pull-up's provided by another device. These jumpers **MUST** be removed when using the Raspberry-PI:

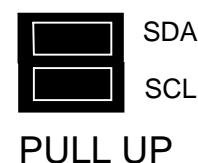

I²C communication

Up to four DS-GPM.S modules may be connected to the same UNO / Raspberry-PI board or I²C bus and

accessed individually using their own individual address. The address is configured with the following jumpers:

ADDRESS



The following table shows how the jumpers are placed for the different binary addresses:

Address xx	A0	A1
00 (default)	ON	ON
01	OFF	ON
10	ON	OFF
11	OFF	OFF

The binary address (xx) above is used in conjunction with the device ID 11010xxD to form the complete device address i.e. if both jumpers are left connected (default) then the device address would be

1101000D_{binary}.

The 'D' bit determines if a read or a write to the GPM is to be performed. If the 'D' bit is set '1' then a register read is performed or if clear '0' a register write.

To access individual registers a device write must be undertaken by the I²C Master which consists of a Start condition, device ID ('D' bit cleared), register to start write, one or more bytes of data to be written and a stop condition (see Figure 1.0 for I²C write protocol).

There are 3 individual registers that can be written within the GPM that control local IO port setup and output as follows:

N₇ N₆ N₅ N₄ N₃ N₂ N₁ N₀

GPM I²C address

1.

1	1	0	1	0	X	X	0
---	---	---	---	---	---	---	---

XX = Address select pins A1 & A0

Register address

2.

U	U	U	U	U	U	B	B
---	---	---	---	---	---	---	---

B..B = 0 to 2
U..U = unused on this implementation

Local I/O port direction register

R0

U	U	U	U	X	X	X	X
---	---	---	---	---	---	---	---

X = 1 or 0 (1 = I/O is input, 0 = I/O is output)
U..U = unused on this implementation

Local I/O port input type register**

R1

U	U	U	U	Y	Y	X	X
---	---	---	---	---	---	---	---

X = 1 or 0 (1 = input pair is ana, 0 = input pair is level)
Y = 1 or 0 (1 = Input pair is ana, 0 = Input pair is level)
U..U = unused on this implementation

Local I/O port output data register

R2

U	U	U	U	X	X	X	X
---	---	---	---	---	---	---	---

X = 1 or 0 (1 = output pin is high, 0 = output pin is low)
U..U = unused on this implementation

To read individual data and status registers a device write then read must be undertaken by the OOPic / I²C Master.

The write consists of a Start condition, device ID ('D' bit clear), register to start read and a Stop condition. This is followed by a read, which consists of a Start condition, device ID ('D' bit set), followed by data from the register specified and terminated with a Stop condition. The GPM also auto increments the register specified for every additional read requested by the Master I²C device, which allows more than one register to be read in one transaction. This allows for example Register 0 to Register 5, current UTC time, to be read in one transaction (see Figure 1.1 for I²C read protocol). There are 112 individual registers that can be read within the GPM as follows:

N₇ N₆ N₅ N₄ N₃ N₂ N₁ N₀

GPM Address

1.

1	1	0	1	0	X	X	1
---	---	---	---	---	---	---	---

XX = Address select pins

Hours tens register

R0

X	X	X	X	X	H	H	H
---	---	---	---	---	---	---	---

H..H = Tens of hours (24 hour clock UTC time)
X..X = not used

Hours units register

R1

X	X	X	X	H	H	H	H
---	---	---	---	---	---	---	---

H..H = Units of hours (24 hour clock UTC time)
X..X = not used

Minutes tens register

R2

X	X	X	X	X	M	M	M
---	---	---	---	---	---	---	---

M..M = Tens of minutes (UTC time)
X..X = not used

Minutes units register

R3

X	X	X	X	M	M	M	M
---	---	---	---	---	---	---	---

M..M = Units of minutes (UTC time)
X..X = not used

Seconds tens register

R4

X	X	X	X	X	S	S	S
---	---	---	---	---	---	---	---

S..S = Tens of seconds (UTC time)
X..X = not used

Seconds units register

R5

X	X	X	X	S	S	S	S
---	---	---	---	---	---	---	---

S..S = Units of seconds (UTC time)
X..X = not used

Day of month tens register

R6

X	X	X	X	X	X	D	D
---	---	---	---	---	---	---	---

D..D = Tens of day of month
X..X = not used

Day of month units register

R7

X	X	X	X	D	D	D	D
---	---	---	---	---	---	---	---

D..D = Units of day of month
X..X = not used

Month tens register

R8

X	X	X	X	X	M	M
---	---	---	---	---	---	---

M..M = Tens of months
X..X = not used

Month units register

R9

X	X	X	X	M	M	M	M
---	---	---	---	---	---	---	---

M..M = Units of months
X..X = not used

Years thousands register

R10

X	X	X	X	X	Y	Y
---	---	---	---	---	---	---

Y..Y = Thousands of years
X..X = not used

Years hundreds register

R11

X	X	X	X	Y	Y	Y	Y
---	---	---	---	---	---	---	---

Y..Y = Hundreds of years
X..X = not used

Years tens register

R12

X	X	X	X	Y	Y	Y	Y
---	---	---	---	---	---	---	---

Y..Y = Tens of years
X..X = not used

Years units register

R13

X	X	X	X	Y	Y	Y	Y
---	---	---	---	---	---	---	---

Y..Y = Units of years
X..X = not used

Latitude degrees tens register

R14

X	X	X	X	D	D	D	D
---	---	---	---	---	---	---	---

D..D = Tens of degrees
X..X = not used

Latitude degrees units register

R15

X	X	X	X	D	D	D	D
---	---	---	---	---	---	---	---

D..D = Units of degrees
X..X = not used

Latitude minutes tens register

R16

X	X	X	X	M	M	M	M
---	---	---	---	---	---	---	---

M..M = Tens of minutes
X..X = not used

Latitude minutes units register

R17

X	X	X	X	M	M	M	M
---	---	---	---	---	---	---	---

M..M = Units of minutes
X..X = not used

Latitude minutes tenths register

R18

X	X	X	X	M	M	M	M
---	---	---	---	---	---	---	---

M..M = Tenths of minutes
X..X = not used

Latitude minutes hundredths register

R19

X	X	X	X	M	M	M	M
---	---	---	---	---	---	---	---

M..M = Hundredths of minutes
X..X = not used

Latitude minutes thousandths register

R20

X	X	X	X	M	M	M	M
---	---	---	---	---	---	---	---

M..M = Thousandths of minutes
X..X = not used

Latitude minutes ten thousandths register

R21

X	X	X	X	M	M	M	M
---	---	---	---	---	---	---	---

M..M = Ten thousandths of minutes
X..X = not used

Latitude direction character

R22

X	D	D	D	D	D	D	D
---	---	---	---	---	---	---	---

D..D = ASCII Character (N = North, S = South)
X..X = not used

Longitude degrees hundreds register

R23

X	X	X	X	X	D	D
---	---	---	---	---	---	---

D..D = Hundreds of degrees
X..X = not used

Longitude degrees tens register

R24

X	X	X	X	D	D	D	D
---	---	---	---	---	---	---	---

D..D = Tens of degrees
X..X = not used

Longitude degrees units register

R25

X	X	X	X	D	D	D	D
---	---	---	---	---	---	---	---

D..D = Units of degrees
X..X = not used

Longitude minutes tens register

R26

X	X	X	X	M	M	M	M
---	---	---	---	---	---	---	---

M..M = Tens of minutes
X..X = not used

Longitude minutes units register

R27

X	X	X	X	M	M	M	M
---	---	---	---	---	---	---	---

M..M = Units of minutes
X..X = not used

Longitude minutes tenths register

R28

X	X	X	X	M	M	M	M
---	---	---	---	---	---	---	---

M..M = Tenths of minutes
X..X = not used

Longitude minutes hundredths register

R29

X	X	X	X	M	M	M	M
---	---	---	---	---	---	---	---

M..M = Hundredths of minutes
X..X = not used

Longitude minutes thousandths register

R30

X	X	X	X	M	M	M	M
---	---	---	---	---	---	---	---

M..M = Thousandths of minutes
X..X = not used

Longitude minutes ten thousandths register

R31

X	X	X	X	M	M	M	M
---	---	---	---	---	---	---	---

M..M = Ten thousandths of minutes
X..X = not used

Longitude direction character

R32

X	D	D	D	D	D	D	D
---	---	---	---	---	---	---	---

D..D = ASCII Character (W = West, E = East)
X..X = not used

GPS quality indicator

R33 [X X X X X X X D D]
D..D = 0 - 2 (0 = No GPS, 1 = GPS, 2 = DGPS)

X..X = not used
Satellites in use tens register
R34 [X X X X X X X S S]
S..S = Tens of satellites in use
X..X = not used

Satellites in use units register

R35 [X X X X X S S S S]
S..S = Units of satellites in use
X..X = not used

HDOP tens register

R36 [X X X X X H H H H]
H..H = Tens of HDOP
X..X = not used

HDOP units register

R37 [X X X X X H H H H]
M..M = Units of HDOP
X..X = not used

HDOP tenths register

R38 [X X X X X H H H H]
M..M = Tenths of HDOP
X..X = not used

Altitude metres tens of thousands register

R39 [X X X X X X X X A]
A = Tens of thousands of metres
X..X = not used

Altitude metres thousands register

R40 [X X X X X A A A A]
A..A = Thousands of metres
X..X = not used

Altitude metres hundreds register

R41 [X X X X X A A A A]
A..A = Hundreds of metres
X..X = not used

Altitude metres tens register

R42 [X X X X X A A A A]
A..A = Tens of metres
X..X = not used

Altitude metres units register

R43 [X X X X X A A A A]
A..A = Units of metres
X..X = not used

Heading degrees (true North) hundreds register

R44 [X X X X X X X H H]
H..H = Hundreds of degrees
X..X = not used

Heading degrees (true North) tens register

R45 [X X X X X H H H H]
H..H = Tens of degrees
X..X = not used

Heading degrees (true North) units register

R46 [X X X X X H H H H]
H..H = Units of degrees
X..X = not used

Heading degrees (true North) tenths register

R47 [X X X X X H H H H]
H..H = Tenths of degrees
X..X = not used

Heading degrees (Magnetic North) hundreds register

R48 [X X X X X X X H H]
H..H = Hundreds of degrees
X..X = not used

Heading degrees (Magnetic North) tens register

R49 [X X X X X H H H H]
H..H = Tens of degrees
X..X = not used

Heading degrees (Magnetic North) units register

R50 [X X X X X H H H H]
H..H = Units of degrees
X..X = not used

Heading degrees (Magnetic North) tenths register

R51 [X X X X X H H H H]
H..H = Tenths of degrees
X..X = not used

Speed hundreds register

R52 [X X X X X X X S S]
S..S = Hundreds of kilometres per hour
X..X = not used

Speed tens register

R53 [X X X X X S S S S]
S..S = Tens of kilometres per hour
X..X = not used

Speed units register

R54 [X X X X X S S S S]
S..S = Units of kilometres per hour
X..X = not used

Speed tenths register

R55 [X X X X X S S S S]
S..S = Tenths of kilometres per hour
X..X = not used

GPS Mode character

R56 [X D D D D D D D D]
D..D = ASCII character (A = Autonomous Mode, D = Differential Mode, E = Estimated (dead reckoning) Mode, M = Manual Input Mode, S = Simulated Mode, N = Data Not Valid)

Satellites in view tens register

R57 [X X X X X X X S S]
S..S = Tens of satellites in view
X..X = not used

Satellites in view units register

R58 [X X X X X S S S S]
S..S = Units of satellites in view
X..X = not used

Satellite 1 ID number tens register

R59 [X X X X X X X S S]
S..S = Tens of satellite ID number
X..X = not used

Satellite 1 ID number units register

R60 [X X X X X S S S S]
S..S = Units of satellite ID number
X..X = not used

Satellite 1 signal level tens register

R61 [X X X X X L L L L]
L..L = Tens of satellite signal level
X..X = not used

Satellite 1 signal level units register

R62 [X X X X X L L L L]
L..L = Units of satellite signal level
X..X = not used

Satellite 2 ID number tens register

R63 [X X X X X X X S S]
S..S = Tens of satellite ID number
X..X = not used

Satellite 2 ID number units register

R64 [X X X X X S S S S]
S..S = Units of satellite ID number
X..X = not used

Satellite 2 signal level tens register

R65 [X X X X X L L L L]
L..L = Tens of satellite signal level
X..X = not used

Satellite 2 signal level units register

R66 [X X X X X L L L L]
L..L = Units of satellite signal level
X..X = not used

Satellite 3 ID number tens register

R67 [X X X X X X X S S]
S..S = Tens of satellite ID number
X..X = not used

Satellite 3 ID number units register

R68 [X X X X X S S S S]
S..S = Units of satellite ID number
X..X = not used

Satellite 3 signal level tens register

R69 [X X X X X L L L L]
L..L = Tens of satellite signal level
X..X = not used

Satellite 3 signal level units register

R70 [X X X X X L L L L]
L..L = Units of satellite signal level
X..X = not used

Satellite 4 ID number tens register

R71 [X X X X X X X S S]
S..S = Tens of satellite ID number
X..X = not used

Satellite 4 ID number units register

R72 [X X X X X S S S S]
S..S = Units of satellite ID number
X..X = not used

Satellite 4 signal level tens register

R73 [X X X X X L L L L]
L..L = Tens of satellite signal level
X..X = not used

Satellite 4 signal level units register

R74 [X X X X X L L L L]
L..L = Units of satellite signal level
X..X = not used

Satellite 5 ID number tens register

R75 [X X X X X X X S S]
S..S = Tens of satellite ID number
X..X = not used

Satellite 5 ID number units register

R76 [X X X X X S S S S]
S..S = Units of satellite ID number
X..X = not used

Satellite 5 signal level tens register

R77 [X X X X X L L L L]
L..L = Tens of satellite signal level
X..X = not used

Satellite 5 signal level units register

R78 [X X X X X L L L L]
L..L = Units of satellite signal level
X..X = not used

Satellite 6 ID number tens register

R79 [X X X X X X X S S]
S..S = Tens of satellite ID number
X..X = not used

Satellite 6 ID number units register

R80 [X X X X X S S S S]
S..S = Units of satellite ID number
X..X = not used

Satellite 6 signal level tens register

R81 [X X X X X L L L L]
L..L = Tens of satellite signal level
X..X = not used

Satellite 6 signal level units register

R82 [X X X X X L L L L]
L..L = Units of satellite signal level
X..X = not used

Satellite 7 ID number tens register

R83 [X X X X X X X S S]
S..S = Tens of satellite ID number
X..X = not used

Satellite 7 ID number units register

R84 [X X X X X S S S S]
S..S = Units of satellite ID number
X..X = not used

Satellite 7 signal level tens register

R85 [X X X X X L L L L]
L..L = Tens of satellite signal level
X..X = not used

Satellite 7 signal level units register

R86 [X X X X X L L L L]
L..L = Units of satellite signal level
X..X = not used

Satellite 8 ID number tens register

R87 [X X X X X X X S S]
S..S = Tens of satellite ID number
X..X = not used

Satellite 8 ID number units register

R88 [X X X X X S S S S]
S..S = Units of satellite ID number
X..X = not used

Satellite 8 signal level tens register

R89 [X X X X X L L L L]
L..L = Tens of satellite signal level
X..X = not used

Satellite 8 signal level units register

R90 [X X X X X L L L L]
L..L = Units of satellite signal level
X..X = not used

Satellite 9 ID number tens register

R91 [X X X X X X X S S]
S..S = Tens of satellite ID number
X..X = not used

Satellite 9 ID number units register

R92 [X X X X X S S S S]
S..S = Units of satellite ID number
X..X = not used

Satellite 9 signal level tens register

R93 [X X X X X L L L L]
L..L = Tens of satellite signal level
X..X = not used

Satellite 9 signal level units register

R94 [X X X X X L L L L]
L..L = Units of satellite signal level
X..X = not used

Satellite 10 ID number tens register
R95

X	X	X	X	X	X	X	S	S
---	---	---	---	---	---	---	---	---

S..S = Tens of satellite ID number
X..X = not used

Satellite 10 ID number units register
R96

X	X	X	X	X	L	S	S	S
---	---	---	---	---	---	---	---	---

S..S = Units of satellite ID number
X..X = not used

Satellite 10 signal level tens register
R97

X	X	X	X	X	L	L	L	L
---	---	---	---	---	---	---	---	---

L..L = Tens of satellite signal level
X..X = not used

Satellite 10 signal level units register
R98

X	X	X	X	X	L	L	L	L
---	---	---	---	---	---	---	---	---

L..L = Units of satellite signal level
X..X = not used

Satellite 11 ID number tens register
R99

X	X	X	X	X	X	X	S	S
---	---	---	---	---	---	---	---	---

S..S = Tens of satellite ID number
X..X = not used

Satellite 11 ID number units register
R100

X	X	X	X	X	L	S	S	S
---	---	---	---	---	---	---	---	---

S..S = Units of satellite ID number
X..X = not used

Satellite 11 signal level tens register
R101

X	X	X	X	X	L	L	L	L
---	---	---	---	---	---	---	---	---

L..L = Tens of satellite signal level
X..X = not used

Satellite 11 signal level units register
R102

X	X	X	X	X	L	L	L	L
---	---	---	---	---	---	---	---	---

L..L = Units of satellite signal level
X..X = not used

Satellite 12 ID number tens register
R103

X	X	X	X	X	X	X	S	S
---	---	---	---	---	---	---	---	---

S..S = Tens of satellite ID number
X..X = not used

Satellite 12 ID number units register
R104

X	X	X	X	X	S	S	S	S
---	---	---	---	---	---	---	---	---

S..S = Units of satellite ID number
X..X = not used

Satellite 12 signal level tens register
R105

X	X	X	X	X	L	L	L	L
---	---	---	---	---	---	---	---	---

L..L = Tens of satellite signal level
X..X = not used

Satellite 12 signal level units register
R106

X	X	X	X	X	L	L	L	L
---	---	---	---	---	---	---	---	---

L..L = Units of satellite signal level
X..X = not used

Local analogue input AN0 value
R107

D	D	D	D	D	D	D	D	D
---	---	---	---	---	---	---	---	---

D..D = 0 to 255 (Analogue input value for AN0 input)
D = 0 if IO line is configured for a normal input

Local analogue input AN1 value
R108

D	D	D	D	D	D	D	D	D
---	---	---	---	---	---	---	---	---

D..D = 0 to 255 (Analogue input value for AN1 input)
D = 0 if IO line is configured for a normal input

Local analogue input AN2 value
R109

D	D	D	D	D	D	D	D	D
---	---	---	---	---	---	---	---	---

D..D = 0 to 255 (Analogue input value for AN2 input)
D = 0 if IO line is configured for a normal input

Local analogue input AN3 value
R110

D	D	D	D	D	D	D	D	D
---	---	---	---	---	---	---	---	---

D..D = 0 to 255 (Analogue input value for AN3 input)
D = 0 if IO line is configured for a normal input

Local I/O port input value
R111

X	X	X	X	X	D	D	D	D
---	---	---	---	---	---	---	---	---

D = 1 or 0 (1 = input pin is high, 0 = input pin is low)
D = 0 if IO line is configured for analogue input

DS-GPM.S Status
R112

U	U	B	A	V	V	V	V
---	---	---	---	---	---	---	---

V..V = Firmware version number 1-15
A = Position found bit (0 = Not found, 1 = Found)
B = Motion bit (0 = Standstill, 1 = Moving)

Registers R0 to R106 may contain invalid data until satellite information has been gained and stored.

** Note: Analogue inputs can only be configured in pairs IO1&2 and IO3&4.

Register restoration...

All received data is formatted into decimal units (i.e. hundreds, tens & units) and stored in individual registers to facilitate either value or character restoration.

Value restoration can be undertaken by multiplying the required register by its multiplier e.g. to restore the value of register R0 'Hours tens' the register contents are multiplied by ten (10).

Character restoration, to allow the output to a PC via. RS232 or display of data on a LCD panel etc., can be undertaken by the addition of the constant value 48_{decimal} 30_{hex}.

UTC Time format...

The standard GPS time coordinate system is called Universal Coordinated Time or UTC.

This time format replaced Greenwich Mean Time (GMT) in 1986 and is of the same value. Time zones relative to GMT should add or subtract a standard value to gain the correct time.

Example.

To read the complete time from registers 0 to 5 (Current time = 14:32:56, Device address = default) write:

'Point to register 0
Byte 1 (GPM Adr) 11010000_{binary}
Byte 2 (Set register) 0_{decimal}, 00_{hex}

'Read register 0 - 5
Byte 1 (GPM Adr) 11010001_{binary}
Byte 2 Hours tens 1_{decimal}, 01_{hex}
Byte 3 Hours units 4_{decimal}, 04_{hex}
Byte 4 Minutes tens 3_{decimal}, 03_{hex}
Byte 5 Minutes units 2_{decimal}, 02_{hex}
Byte 6 Seconds tens 5_{decimal}, 05_{hex}
Byte 7 Seconds units 6_{decimal}, 06_{hex}

Battery replacement

The DS-GPM.S backup battery needs replacing if the real time clock resets to the year 2006 or time to first fix is significantly long. The CR1220 type lithium battery can be replaced by removing the four screws in the base of the module, removing the cover, sliding out the old battery, sliding in a new battery [positive uppermost] and replacing the cover and screws. Please dispose of the exhausted battery responsibly.

See the website at www.designersystems.co.uk for sample Arduino and Raspberry-PI applications.

Electrical Characteristics (T_A = 25°C Typical)

Parameter	Minimum	Maximum	Units	Notes
Supply Voltage (7-16V)	7	16	V	1
Supply Current	30	90	mA	4
I ² C speed	-	400	kHz	
I ² C pull-up resistance	-	4700	Ω	3
GPS positional accuracy	1	2.5	Metres	
GPS frequency band	-	1575.42	MHz	2
GPS channels	-	56		
ADC input voltage	0	V _{cc}	V	
ADC measurement cycle	-	100	mS	
IO line output voltage	0.3	V _{cc} -0.8V	V	
IO line output current	-	20	mA	
IO line input voltage	0	V _{cc} +0.3V	V	

Absolute Maximum Ratings

Parameter	Minimum	Maximum	Units
Supply Voltage (7-16V)	-0.5	+18	V

Environmental

Parameter	Minimum	Maximum	Units
Operating Temperature	0	70	°C
Storage Temperature	-10	80	°C
Humidity	0	80	%
Dimensions	Length 56.25mm, Width 53.5mm, Height 20mm		
Weight	28g		
Immunity & emissions	See statement on page 11		

Notes:

1. Supply voltage is supply rail from Arduino board or any other 7-16V supply.
2. L1 frequency, C/A code (Standard Positioning Service)
3. Value given is to Vcc when activated with appropriate jumpers.
4. Maximum value is only during initial acquisition.

Figure 1.0 (I²C write protocol)

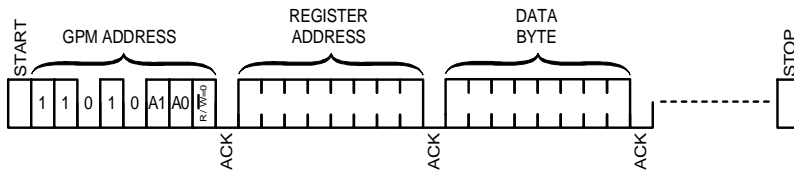

Multiple bytes may be written before the 'STOP' condition. Data is written into registers starting at 'REGISTER ADDRESS', then 'REGISTER ADDRESS' +1, then 'REGISTER ADDRESS' +2 etc. Each byte transfer is acknowledged 'ACK' by the GPM until the 'STOP' condition.

Figure 1.1 (I²C read protocol)

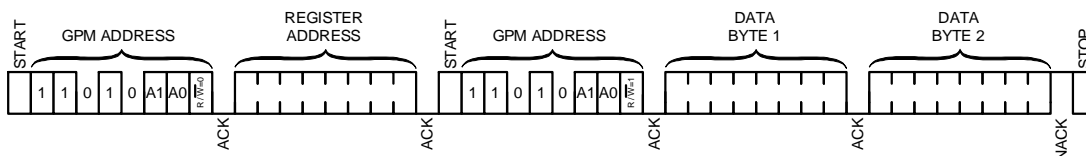

'DATA BYTE 1 & 2' are register values returned from the GPM. Each byte written is acknowledged 'ACK' by the GPM, every byte read is acknowledged 'ACK' by the I²C Master. A Not-acknowledge 'NACK' condition is generated by the I²C Master when it has finished reading.

Figure 2.0 (Connection Schematic for Arduino UNO or Raspberry-Pi I²C communication)

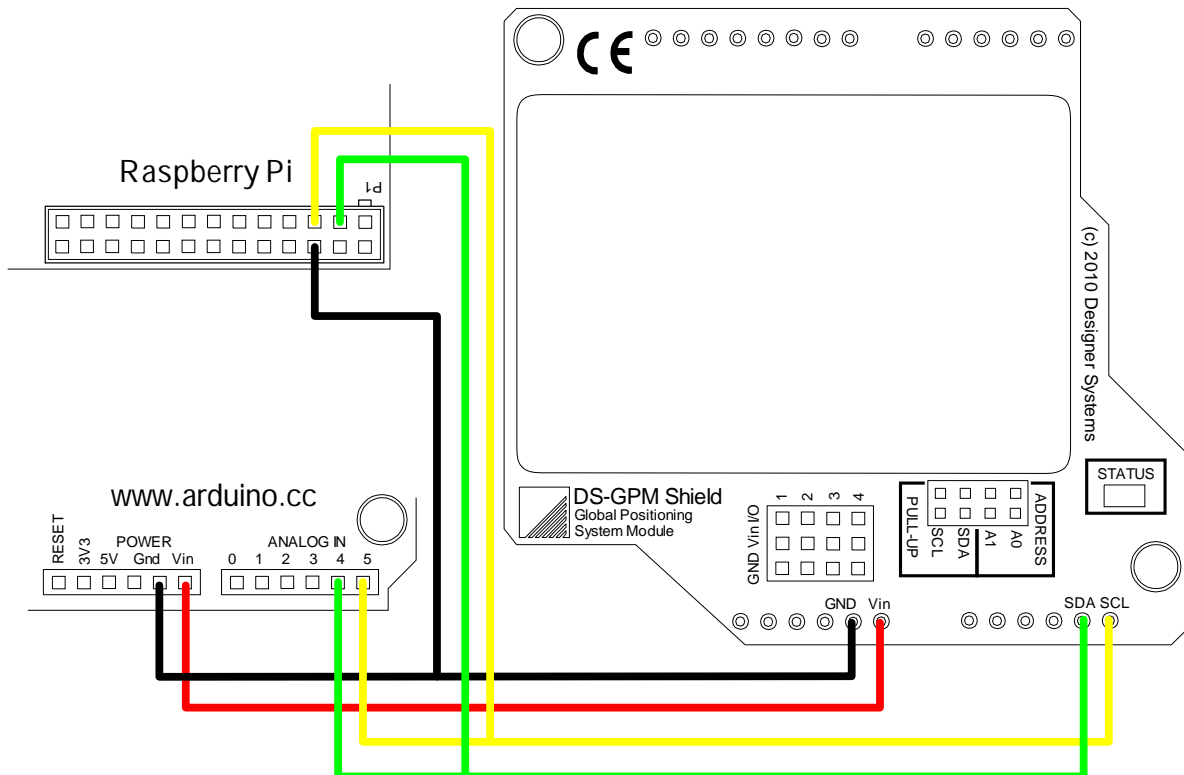
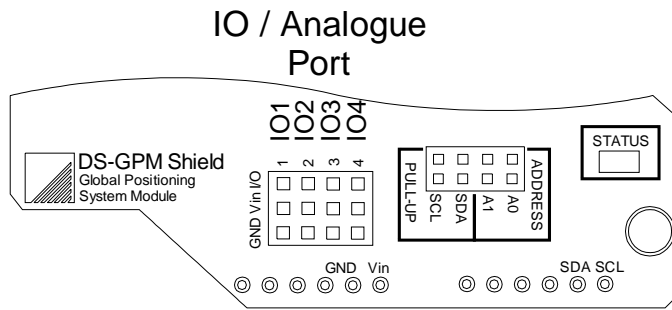
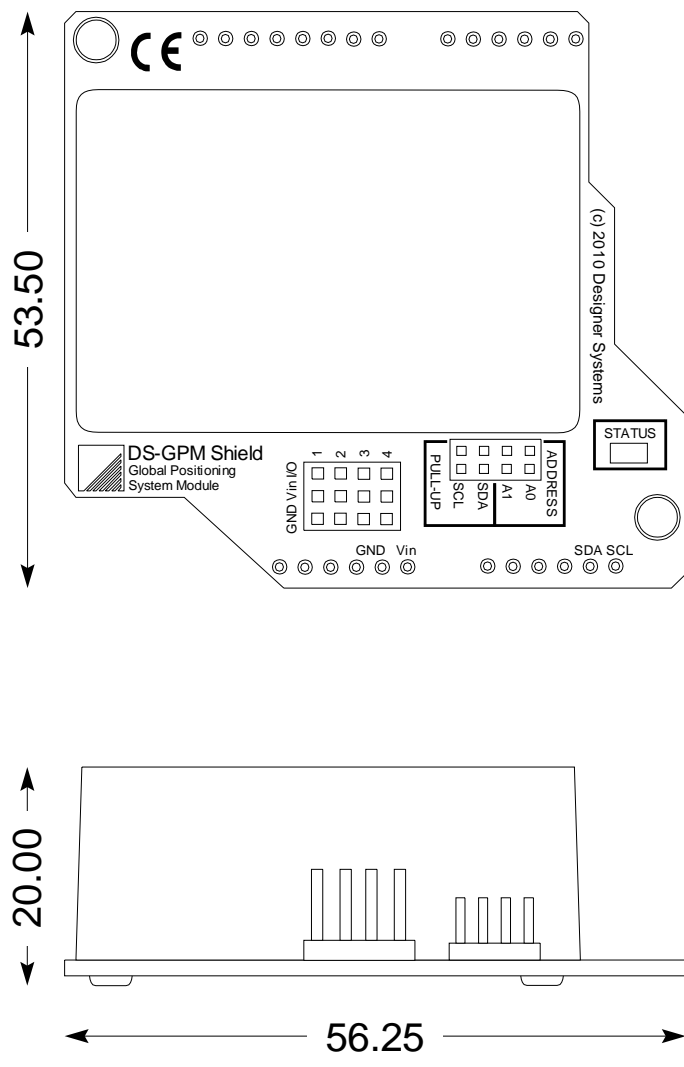

Figure 3.0 (I/O connections)



Mechanical Specifications – Units millimetres



Revision History:

- 1.00 Release version
- 1.01 Release version (Updated IO registers and HDOP registers, added battery recycling statement)
- 1.02 Release version (Added UNO board)
- 1.03 Release version (Added Raspberry-PI information)



WEEE Consumer Notice

This product is subject to Directive 2002/96/EC of the European Parliament and the Council of the European Union on Waste of Electrical and Electronic Equipment (WEEE) and, in jurisdictions adopting that Directive, is marked as being put on the market after August 13, 2005, and should not be disposed of as unsorted municipal/public waste. Please utilise your local WEEE collection facilities in the disposition and otherwise observe all applicable requirements. For further information on the requirements regarding the disposition of this product in other languages please visit www.designersystems.co.uk



RoHS Compliance

This product complies with Directive 2002/95/EC of the European Parliament and the Council of the European Union on the Restriction of Hazardous Substances (RoHS) which prohibits the use of various heavy metals (lead, mercury, cadmium, and hexavalent chromium), polybrominated biphenyls (PBB) and polybrominated diphenyl ethers (PBDE).



Battery Recycling

The DS-GPM features an internal lithium coin cell that must be recycled at end of life. To access the cell remove the four (4) screws in the bottom of the product and lift off the plastic cover. Using the end of a paper clip, screw driver or other form of pointed tool slide the coin cell from its holder. To preserve natural resources, please recycle the battery properly.

Declaration of Conformity

Apparatus name / model number DS-GPM.S

Conformity via Generic Standard EN50081-1

Generic Standard EN50082-1

Conformity criteria For use only within commercial, residential and light industrial applications

We certify that the apparatus identified above conforms to the requirements of Council Directive 2004/108/EC & 2006/95/EC

Signed.

Date 14/5/10

Copyright © 1997-2010 by Designer Systems Ltd

Manufacturer Designer Systems, 11 Castle Street, Truro, Cornwall

TR1 3AF, United Kingdom

Description of apparatus Robotic interface peripheral

Having made this declaration the CE mark is affixed to this product, its packaging, manual or warranty.

The information appearing in this data sheet is believed to be accurate at the time of publication. However, Designer Systems assumes no responsibility arising from the use of the information supplied. The applications mentioned herein are used solely for the purpose of illustration and Designer Systems makes no warranty or representation that such applications will be suitable without further modification, nor recommends the use of its products for application that may present a risk to human life due to malfunction or otherwise. Designer Systems reserves the right to alter its products without prior notification.