



SL 61

Industrial Circular Connectors



ROHS VERSIONS

- Black coating
- Nickel plating

MAIN CHARACTERISTICS

- Closed entry female contacts
 - Two parts backshell ensuring simple wiring and maintenance
 - Adaptable capacity cable clamp
 - Gold plated turned contacts
 - Reinforced locking ring
 - Trapezoidal thread screw-locking
 - Solder contacts
 - Please contact us for other contact terminations
 - for crimping
 - for soldering with earth protection
 - Size 40 one piece backshell (please consult us)
 - Working temperature:
 - 40°C / + 85°C
 - Current capability:
 - 7.5, 10, 25 and 50 Amps
 - Operating voltage:
 - to 600 Volts
 - ROHS versions available
 - black coating (non conductive)
 - nickel plating (conductive)
 - UL recognition n° E160967(01)
-
- Large selection of insert arrangements
 - Robust and reliable
 - Stock items



DESCRIPTION

Principally aimed at I/O applications, the SL61 connectors are available in 4 types of housing (10, 20, 30 and 40) and 26 arrangements from 2 to 61 mixed solder contacts. They are available in the following configurations:

- Plugs
- Receptacles
- Line mount receptacles
- Receptacles with locking ring

Connectors are made of aluminium alloy which provides them excellent reliability and robustness.

When application requires greater performances, the sealing can be improved by the use of a sprayproofing sleeve.

*Robustness
and reliability*

APPLICATIONS

- Automation
- Instrumentation
- Robotics
- Power distribution
- Transport
- Entertainment (brand-lights)



Amphenol

SL 61

Contact arrangements

①	② (Vrms)	③ (Vrms)	①	② (Vrms)	③ (Vrms)	①	② (Vrms)	③ (Vrms)	①	② (Vrms)	③ (Vrms)
13 U	14 V	17 P	22 B	23 C	23 AL	25 D	25 S	27 E	29 AE	212 AF	
280	225	150	500	440	540	380	380	380	280	280	
1400	1400	1050	2100	1400	1750	1400	1400	1400	1400	1050	
①	② (Vrms)	③ (Vrms)	①	② (Vrms)	③ (Vrms)	①	② (Vrms)	③ (Vrms)			
222 P	32 F	33 G	34 H	315 K	319 L	37 Y	39 J	337 P			
150	525	600	500	355	400	480	450	175			
1050	1750	1750	1750	1750	1750	1750	1750	1050			
①	② (Vrms)	③ (Vrms)	①	② (Vrms)	③ (Vrms)						
443 AP	461 P	48 M	419 AR	426 P	439 R						
300	110	420	400	380	280						
1750	1050	2500	1750	1750	1750						

- ① Contact arrangement
- ② Working voltage
- ③ Test voltage at sea level

Nominal current	Contact resistance	Maximum permissible wire dia.
• 7,5 A	≤ 5 m Ω	0.75 mm ²
○ 10 A	≤ 2 m Ω	1.75 mm ²
● 25 A	≤ 2 m Ω	5.1 mm ²
⊕ 50 A	≤ 2 m Ω	13 mm ²





REMARK: the second and the third digit of the contact arrangements (if the third exists) indicate the number of contacts in the arrangement.
Ex.: 426P = 26 contacts.

Straight or right-angle backshell

Connector size	Backshell reference					
	black* (non conductive)	straight nickel* (conductive)	green cadmium (conductive)	black* (non conductive)	right-angle nickel* (conductive)	green cadmium (conductive)
10	47377N	47377NI	21458N	47381N	47381NI	21462N
20	47378N	47378NI	21459N	47382N	47382NI	21463N
30	47379N	47379NI	21460N	47383N	47383NI	21464N
40	47380N	47380NI	21461N	47384N	47384NI	21465N

- * Black and Nickel backshells are ROHS compliant
- Straight or right-angle backshells are delivered with different clamping pads.
- Green backshells (conductive finish) are delivered with metallised clamping pads.

Accessories

<p>Plug and receptacle protection caps:</p> <table border="1"> <thead> <tr> <th>SLB</th> <th>F</th> <th>M</th> <th>3B</th> </tr> </thead> <tbody> <tr> <td colspan="2">F: Plug</td> <td colspan="2">E: Receptacle</td> </tr> <tr> <td colspan="2">M: Pin connector</td> <td colspan="2">F: Socket connector</td> </tr> <tr> <td colspan="4">Plug and receptacle: none</td> </tr> <tr> <td colspan="4">Line mount receptacle: R</td> </tr> <tr> <td colspan="4">Size</td> </tr> <tr> <td colspan="2">1B: 10</td> <td colspan="2">3B: 30</td> </tr> <tr> <td colspan="2">2B: 20</td> <td colspan="2">4B: 40</td> </tr> </tbody> </table> 	SLB	F	M	3B	F: Plug		E: Receptacle		M: Pin connector		F: Socket connector		Plug and receptacle: none				Line mount receptacle: R				Size				1B: 10		3B: 30		2B: 20		4B: 40		<p>Receptacle with locking ring protection caps:</p> <table border="1"> <thead> <tr> <th>BF</th> <th>F</th> <th>3B</th> </tr> </thead> <tbody> <tr> <td colspan="3">M: Pin connector</td> </tr> <tr> <td colspan="3">F: Socket connector</td> </tr> <tr> <td colspan="3">Size</td> </tr> <tr> <td colspan="2">1B: 10</td> <td>3B: 30</td> </tr> <tr> <td colspan="2">2B: 20</td> <td>4B: 40</td> </tr> </tbody> </table> 	BF	F	3B	M: Pin connector			F: Socket connector			Size			1B: 10		3B: 30	2B: 20		4B: 40	<p>Sealing sleeve:</p> <table border="1"> <thead> <tr> <th>Connector</th> <th>Size</th> <th>Ref.</th> </tr> </thead> <tbody> <tr> <td>Straight</td> <td>10</td> <td>43458</td> </tr> <tr> <td>Right-angle</td> <td>10</td> <td>43473</td> </tr> <tr> <td rowspan="2">Straight</td> <td rowspan="2">20</td> <td>43456</td> </tr> <tr> <td>44666</td> </tr> <tr> <td rowspan="2">Right-angle</td> <td rowspan="2">40</td> <td>43457</td> </tr> </tbody> </table>  <p>for plug or line mount receptacle</p>	Connector	Size	Ref.	Straight	10	43458	Right-angle	10	43473	Straight	20	43456	44666	Right-angle	40	43457	<p>Adaptator for flexible conduit and PG:</p> <table border="1"> <thead> <tr> <th></th> <th>Connector size</th> <th>PG thread</th> </tr> </thead> <tbody> <tr> <td>SL RF 209N</td> <td>20</td> <td>9</td> </tr> <tr> <td>SL RF 211N</td> <td>20</td> <td>11</td> </tr> <tr> <td rowspan="2">SL RF 313N</td> <td rowspan="2">30</td> <td>13</td> </tr> <tr> <td>16</td> </tr> <tr> <td>SL RF 416N</td> <td>40</td> <td>16</td> </tr> <tr> <td>SL RF 421N</td> <td>40</td> <td>21</td> </tr> <tr> <td>SL RF 429N</td> <td>40</td> <td>29</td> </tr> </tbody> </table> 		Connector size	PG thread	SL RF 209N	20	9	SL RF 211N	20	11	SL RF 313N	30	13	16	SL RF 416N	40	16	SL RF 421N	40	21	SL RF 429N	40	29
SLB	F	M	3B																																																																																								
F: Plug		E: Receptacle																																																																																									
M: Pin connector		F: Socket connector																																																																																									
Plug and receptacle: none																																																																																											
Line mount receptacle: R																																																																																											
Size																																																																																											
1B: 10		3B: 30																																																																																									
2B: 20		4B: 40																																																																																									
BF	F	3B																																																																																									
M: Pin connector																																																																																											
F: Socket connector																																																																																											
Size																																																																																											
1B: 10		3B: 30																																																																																									
2B: 20		4B: 40																																																																																									
Connector	Size	Ref.																																																																																									
Straight	10	43458																																																																																									
Right-angle	10	43473																																																																																									
Straight	20	43456																																																																																									
		44666																																																																																									
Right-angle	40	43457																																																																																									
			Connector size	PG thread																																																																																							
SL RF 209N	20	9																																																																																									
SL RF 211N	20	11																																																																																									
SL RF 313N	30	13																																																																																									
		16																																																																																									
SL RF 416N	40	16																																																																																									
SL RF 421N	40	21																																																																																									
SL RF 429N	40	29																																																																																									

- Caps and sealing sleeves are ROHS compliant

Straight plug

Straight female plug

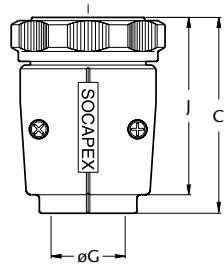

Straight male plug

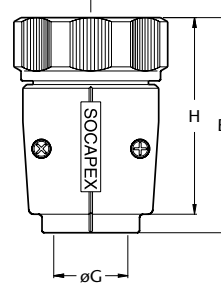

Right angle plug

Right-angle male plug

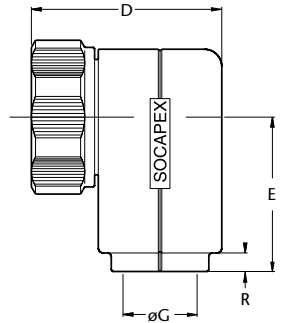

Right-angle female plug

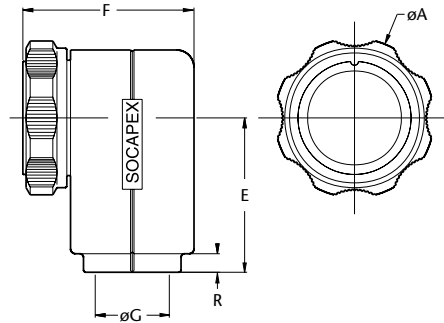

size	$\phi A - 0,2$ (mm)	B (mm)	C (mm)	D (mm)	E (mm)	F (mm)	G (mm)			H (mm)	J (mm)	K (mm)	L (mm)	M (mm)	N (mm)	R (mm)	S (mm)	T (mm)	W (mm)	Y (mm)
10	27.5	61.9	52.9	47.9	45.5	38.9	5-7	7-9	57.4	48.4	21	53.5	57.9	24	4.5	16.5	3.2	19	25	
20	36.5	66.5	59.8	55.5	51.5	48.8	6-8	9-11	62	55.3	28.1	61	59.8	32	4.5	25.5	3.5	24	31	
30	51.5	88.5	80.8	68.5	55.5	60.8	10-12	13-16	82	74.3	42.2	82	80.8	45	6.5	35.5	3.5	34	46	
40	64.5	86.5	78.8	76.5	62.5	68.8	14-18	19-23	79	71.3	52.2	80	79.6	54	7.5	47	3.5	41	56	

G: flanges equipped with different clamping pads delivered with the backshells.

In-line receptacle

In-line male receptacle

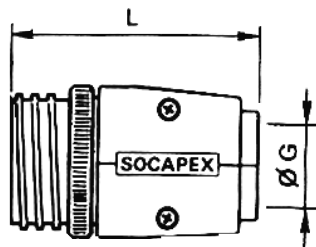

In-line female receptacle

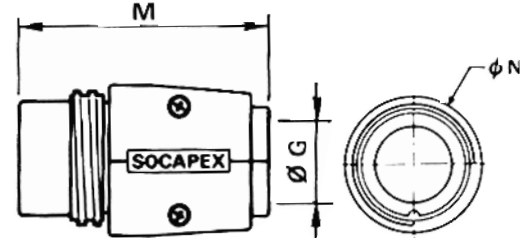

Receptacle

Male receptacle

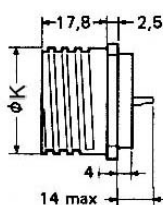

Female receptacle

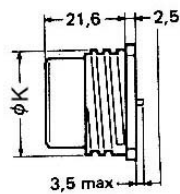

Male receptacle with locking ring

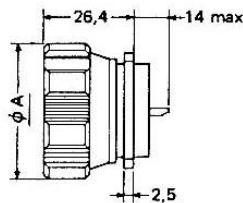

Female receptacle with locking ring

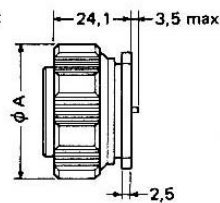

Square flange of receptacle

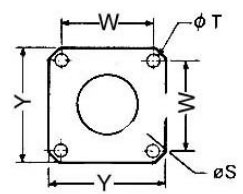

Plug and Inline receptacle (backshell sets included)

ROHS Part Numbers : nickel plated or black coated

SL series	SL	D	F	M	D	319L
D: Black coating						
Blank: Nickel plating						
F: plug or inline receptacle						
Type of contact:						
M: Male						
F: Female						
D: plug + straight backshell						
DR: inline receptacle + straight backshell						
C: plug + right angle backshell						
Contact Arrangement (see page 2)						
Blank: Black coating						
NI: Nickel plating						

Non ROHS Part Numbers : clear cadmium plated

SL series	SL	F	M	D	319L
F : plug or inline receptacle					
Type of contact:					
M: Male					
F: Female					
D: plug + straight backshell					
DR: inline receptacle + straight backshell					
C: plug + right angle backshell					
Contact Arrangement (see page 2)					

Panel mount receptacle and receptacle with locking ring

ROHS Part Numbers : nickel plated or black coated

SL series	SL	D	E	F	319L
D: Black coating					
Blank: Nickel plating					
E: receptacle or receptacle with locking ring					
Type of contact:					
M: Male					
F: Female					
Blank: Receptacle					
E: Receptacle with locking ring					
Contact Arrangement (see page 2)					
Blank: Black coating					
NI: Nickel plating					
Add "MA" for tin plated retention ring (grounding)					

Comment : Panel gasket is delivered with the receptacle

Non ROHS Part Numbers : clear cadmium plated

SL series	SL	E	F	319L
E: receptacle or receptacle with locking ring				
Type of contact:				
M: Male				
F: Female				
Blank: Receptacle				
E: Receptacle with locking ring				
Contact Arrangement (see page 2)				
Add "MA" for tin plated retention ring (grounding)				

Comment : Panel gasket is delivered with the receptacle

Body of plug and inline receptacle

With those part numbers the straight and right angle backshells are not included. To define part numbers of backshells, please to consult page 2.

ROHS Part Numbers : nickel plated or black coated

SL series	SL	D	B	M	319L
D: Black coating					
Blank: Nickel plating					
Body of plug or inline receptacle					
Type of contact:					
M: Male					
F: Female					
Blank: Body of plug					
R: Body of inline receptacle					
Contact Arrangement (see page 2)					
Blank: Black coating					
NI: Nickel plating					

Non ROHS Part Numbers : clear cadmium plated

SL series	SL	B	M	319L
Body of plug or inline receptacle				
Type of contact:				
M: Male				
F: Female				
Blank: Plug				
R: inline receptacle				
Contact Arrangement (see page 2)				

Do not hesitate to contact us for further information



Amphenol Socapex

948, Promenade de l'Arve - BP 29

F - 74311 Thyez Cedex

Tel.: +33 (0) 4 50 89 28 00 - Fax: +33 (0) 4 50 96 29 75

<http://www.amphenol-socapex.com>