



ATTENTION
 OBSERVE PRECAUTIONS
 FOR HANDLING
 ELECTROSTATIC
 DISCHARGE
 SENSITIVE
 DEVICES

Features

- Outstanding material efficiency.
- Reliable and rugged.
- RoHS compliant.

Description

The Blue source color devices are made with InGaN Light Emitting Diode.

Static electricity and surge damage the LEDs.

It is recommended to use a wrist band or anti-electrostatic glove when handling the LEDs.

All devices, equipment and machinery must be electrically grounded.

Package Dimensions

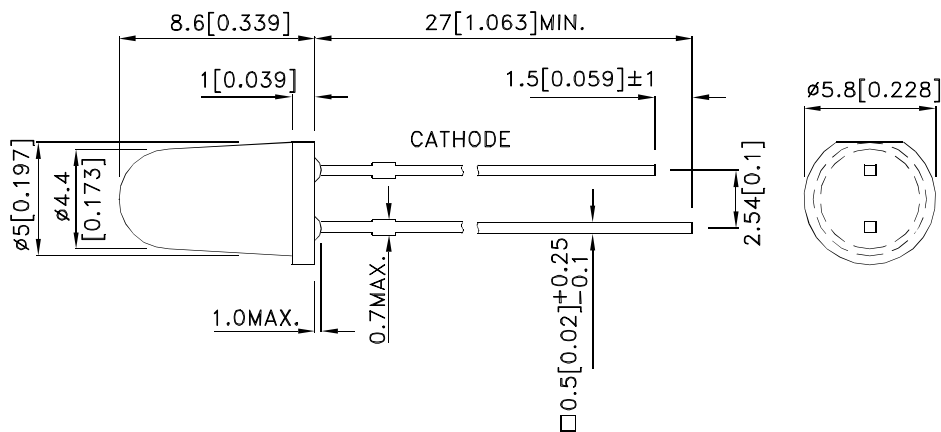

Notes:

1. All dimensions are in millimeters (inches).
2. Tolerance is $\pm 0.25 (0.01)$ unless otherwise noted.
3. Lead spacing is measured where the leads emerge from the package.
4. The specifications, characteristics and technical data described in the datasheet are subject to change without prior notice.



Selection Guide

Part No.	Dice	Lens Type	Iv (mcd) [2] @ 20mA		Viewing Angle [1]
			Min.	Typ.	2θ1/2
L-2523QBC-D	Blue (InGaN)	Water Clear	1300	2300	12°

Notes:

1. θ1/2 is the angle from optical centerline where the luminous intensity is 1/2 of the optical peak value.
2. Luminous intensity/ luminous Flux: +/-15%.
3. Luminous intensity value is traceable to the CIE127-2007 compliant national standards.

Electrical / Optical Characteristics at TA=25°C

Symbol	Parameter	Device	Typ.	Max.	Units	Test Conditions
λ_{peak}	Peak Wavelength	Blue	460		nm	I _F =20mA
λ_D [1]	Dominant Wavelength	Blue	465		nm	I _F =20mA
$\Delta\lambda_{1/2}$	Spectral Line Half-width	Blue	25		nm	I _F =20mA
C	Capacitance	Blue	100		pF	V _F =0V;f=1MHz
V _F [2]	Forward Voltage	Blue	3.3	4	V	I _F =20mA
I _R	Reverse Current	Blue		50	uA	V _R = 5V

Notes:

1. Wavelength: +/-1nm.
2. Forward Voltage: +/-0.1V.
3. Wavelength value is traceable to the CIE127-2007 compliant national standards.

Absolute Maximum Ratings at TA=25°C

Parameter	Blue	Units
Power dissipation	120	mW
DC Forward Current	30	mA
Peak Forward Current [1]	150	mA
Reverse Voltage	5	V
Operating/Storage Temperature	-40°C To +85°C	
Lead Solder Temperature [2]	260°C For 3 Seconds	
Lead Solder Temperature [3]	260°C For 5 Seconds	

Notes:

1. 1/10 Duty Cycle, 0.1ms Pulse Width.
2. 2mm below package base.
3. 5mm below package base.

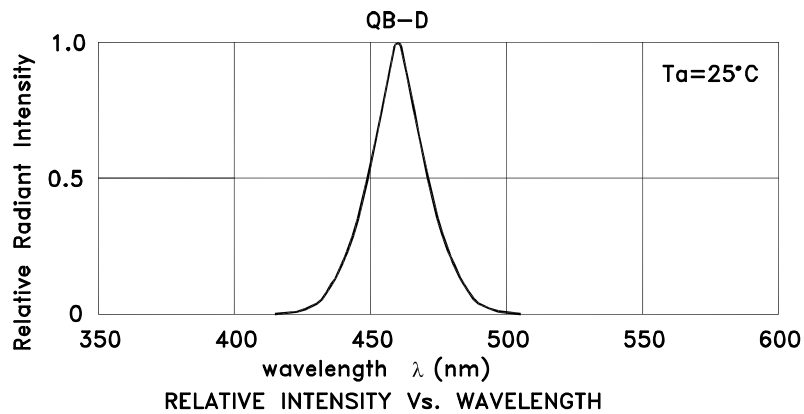

Blue

L-2523QBC-D

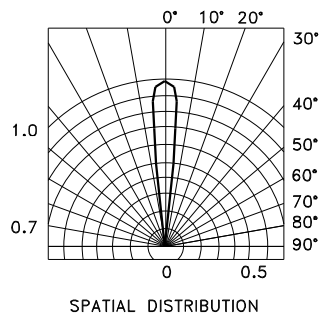
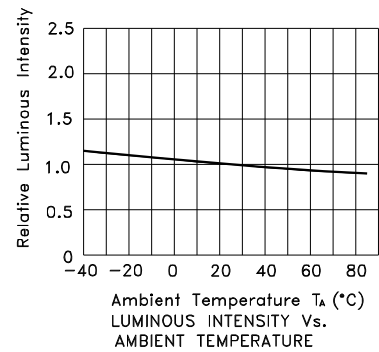
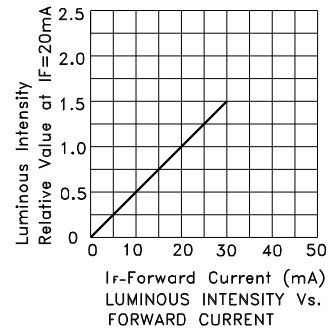
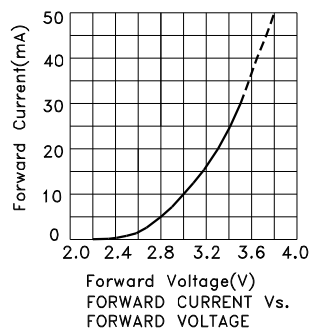

PACKING & LABEL SPECIFICATIONS

L-2523QBC-D

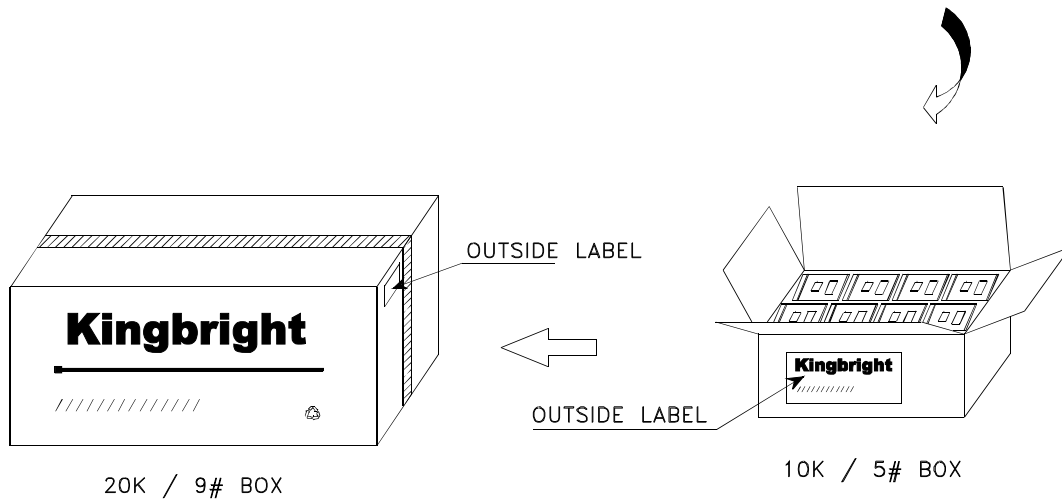
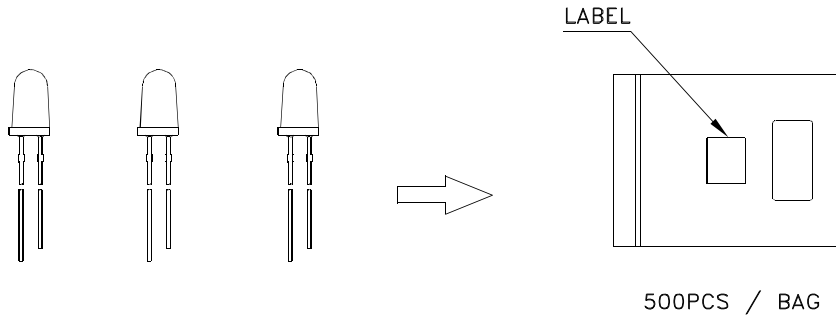

<h1>Kingbright</h1>				
P/NO: L-2523xxx				
QTY: 500 pcs	Q.C. <table border="1"><tr><td>Q C</td></tr><tr><td>XX XX XXXX</td></tr><tr><td>PASSED</td></tr></table>	Q C	XX XX XXXX	PASSED
Q C				
XX XX XXXX				
PASSED				
S/N: XXXX				
CODE: XXX				
LOT NO:				
 XXXXXXXXXXXXXXXXXXXXXXXX				
RoHS Compliant				

PRECAUTIONS

1. The lead pitch of the LED must match the pitch of the mounting holes on the PCB during component placement. Lead-forming may be required to insure the lead pitch matches the hole pitch. Refer to the figure below for proper lead forming procedures. (Fig. 1)



Fig.1

”○” Correct mounting method ”×” Incorrect mounting method

2. When soldering wire to the LED, use individual heat-shrink tubing to insulate the exposed leads to prevent accidental contact short-circuit. (Fig.2)
3. Use stand-offs (Fig.3) or spacers (Fig.4) to securely position the LED above the PCB.



Fig. 2

Fig. 3

Fig. 4

4. Maintain a minimum of 2mm clearance between the base of the LED lens and the first lead bend. (Fig. 5 and 6)
5. During lead forming, use tools or jigs to hold the leads securely so that the bending force will not be transmitted to the LED lens and its internal structures. Do not perform lead forming once the component has been mounted onto the PCB. (Fig. 7)

6. Do not bend the leads more than twice. (Fig. 8)

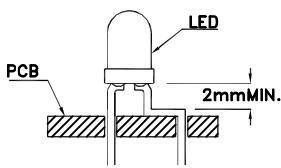

Fig. 5

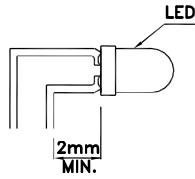

Fig. 6

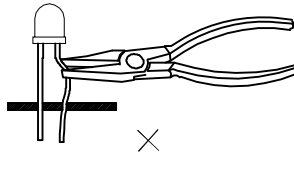

Fig. 7

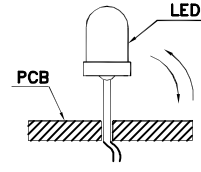
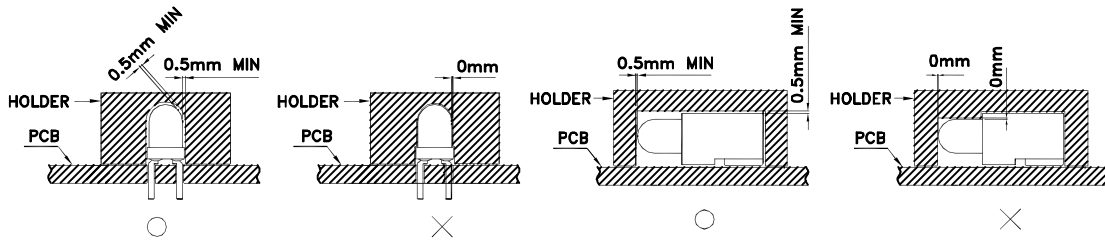

Fig. 8

7. During soldering, component covers and holders should leave clearance to avoid placing damaging stress on the LED during soldering.



8. The tip of the soldering iron should never touch the lens epoxy.

9. Through-hole LEDs are incompatible with reflow soldering.

10. If the LED will undergo multiple soldering passes or face other processes where the part may be subjected to intense heat, please check with Kingbright for compatibility.

11. Recommended Wave Soldering Profiles:

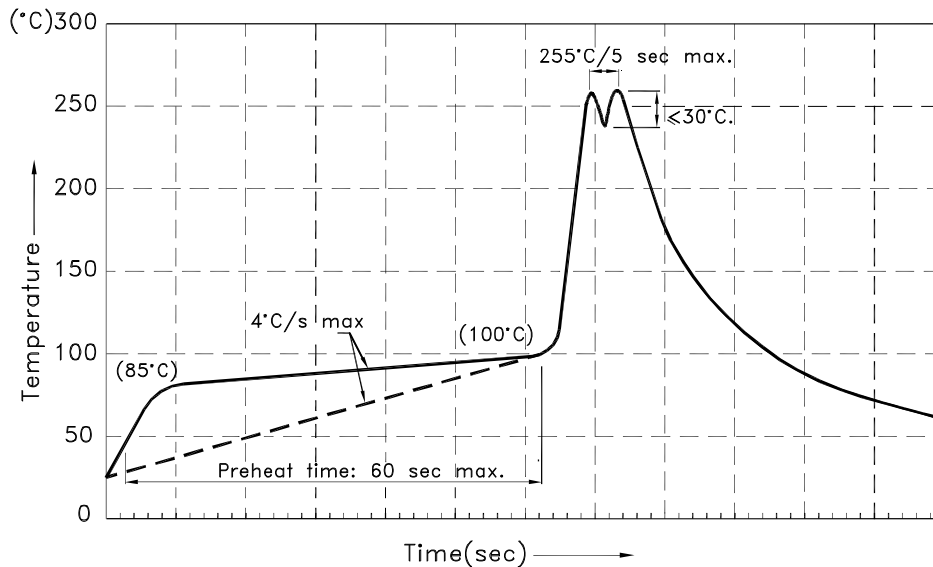

Notes:

1. Recommend pre-heat temperature of 105°C or less (as measured with a thermocouple attached to the LED pins) prior to immersion in the solder wave with a maximum solder bath temperature of 260°C
2. Peak wave soldering temperature between 245°C ~ 255°C for 3 sec (5 sec max).
3. Do not apply stress to the epoxy resin while the temperature is above 85°C.
4. Fixtures should not incur stress on the component when mounting and during soldering process.
5. SAC 305 solder alloy is recommended.
6. No more than one wave soldering pass.

Detailed application notes are listed on our website.

http://www.kingbright.com/application_notes