

# Power Line Filters Appliance Filters

## 62-AL/62-AC Series



Tested and found to be  
IAW VDE 0565 Part 3

### Features

- Low-cost plastic case
- Compact design requires minimal real estate space
- Suitable for products that must conform to FCC regulations
- Wide variety of circuit and filtering options
- Good filtering characteristics for both normal mode and common mode
- Epoxy molded for reliability
- Operating temperature: -25°C to +85°C (including temperature rise, see graph on page 61)

### Applications

- Personal computers and peripherals
- Digital equipment
- Industrial equipment
- Vending machines
- Home appliances
- Office equipment

### Specifications

Model*	Rated Voltage (@ 50/60Hz)	Rated Current	Leakage Current (Max.)	Capacitance		Inductance (L <sub>1</sub> )	Temperature Rise (Max.)	
				C <sub>Y</sub>	C <sub>X</sub>			
62-AFL-010-3-11	250VAC	1.0A	0.35mA	2200pF	0.1uF	11.0mH	40°C	
62-AFC-010-3-11			0.50mA	3300pF				
62-AFL-010-5-11				1.6A				0.35mA
62-AFC-010-5-11			0.50mA					3300pF
62-AFL-016-3-11		3.0A		0.35mA		2200pF		
62-AFC-016-3-11			0.50mA	3300pF				
62-AFL-016-5-11				4.5A		0.35mA		2200pF
62-AFC-016-5-11			0.50mA			3300pF		
62-AFL-030-3-11		6.0A		0.35mA		2200pF		
62-AFC-030-3-11			0.50mA	3300pF				
62-AFL-030-5-11				1.0mH		0.35mA		2200pF
62-AFC-030-5-11			0.50mA			3300pF		
62-AFL-045-3-11		0.53mH		0.35mA		2200pF		
62-AFC-045-3-11			0.50mA	3300pF				
62-AFL-045-5-11				6.0A		0.35mA		2200pF
62-AFC-045-5-11			0.50mA			3300pF		
62-AFL-060-3-11		0.53mH		0.35mA		2200pF		
62-AFC-060-3-11			0.50mA	3300pF				
62-AFL-060-5-11				6.0A		0.35mA		2200pF
62-AFC-060-5-11			0.50mA			3300pF		

Note: All types are designed to meet the requirement of UL 1283, CSA 22.2. VDE 0565-3  
 Test voltage: 1500VAC one minute, line to ground  
 Insulation resistance: 300 Mohm min. at 500VDC  
 Voltage drop: 1V max.

\* Available with bleeder resistor  
 Replace F with R for part number

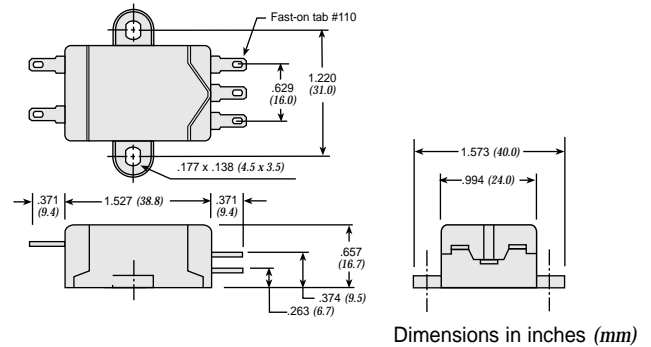

### Circuit Diagrams

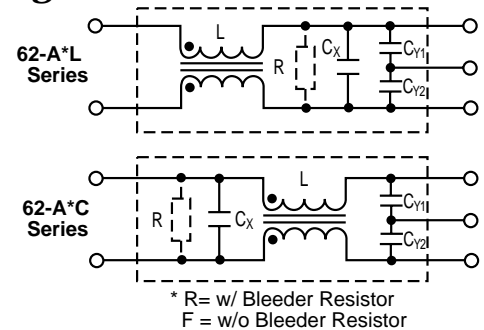

# Power Line Filters Appliance Filters

## 62-AL/62-AC Series

### Common Mode

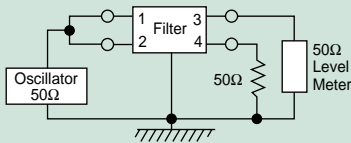

62-AFL-xxx-3-11

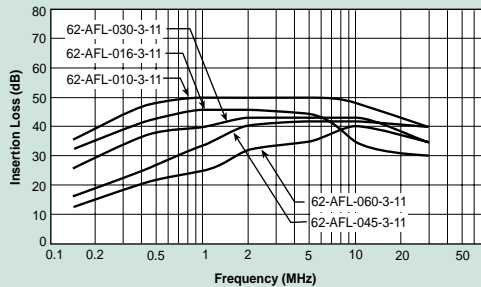

62-AFC-XXX-3-11

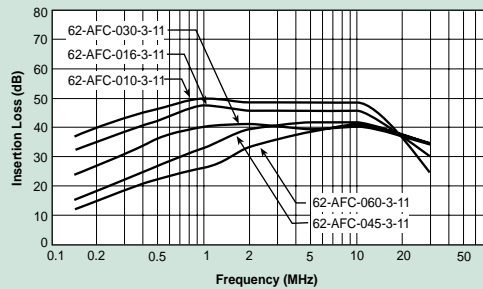

62-AFL-xxx-5-11

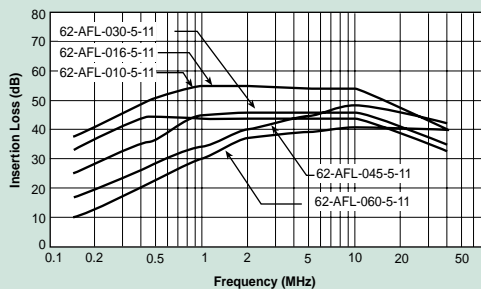

62-AFC-xxx-5-11

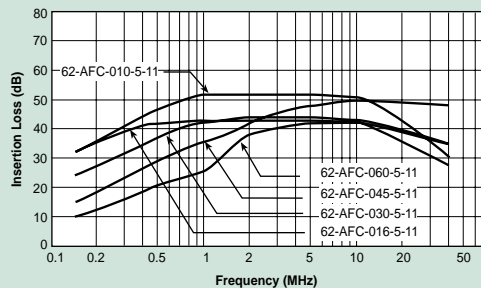

## Temperature Characteristics

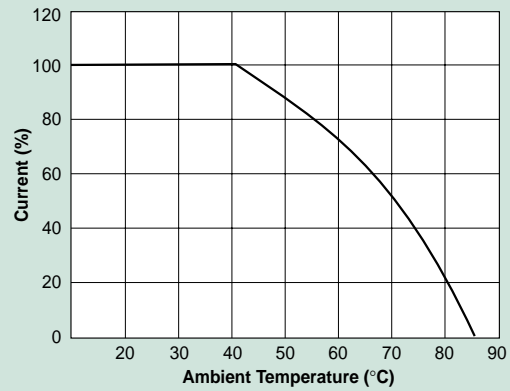

### Normal Mode

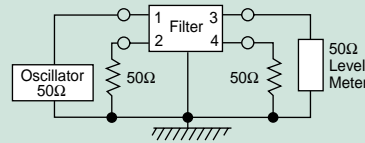

62-AFL-XXX-3-11

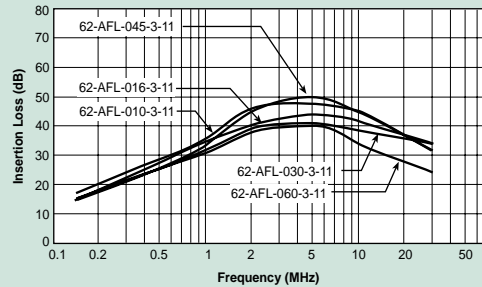

62-AFC-XXX-3-11

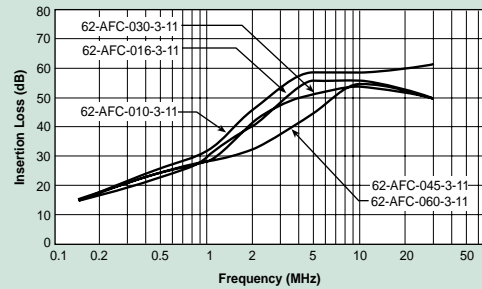

62-AFL-xxx-5-11

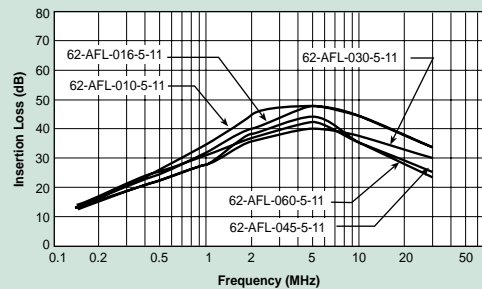

62-AFC-xxx-5-11

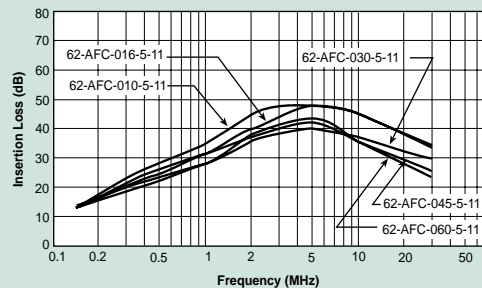

# Power Line Filters Single Stage

## 62-PPF/PQF/PRF Series



Tested and found to be  
IAW VDE 0565 Part 3

### Features

- Low-cost plastic case
- Compact design requires minimal real estate space
- Suitable for products that must conform to FCC and FTZ regulations
- Wide variety of circuit and filtering options
- Good filtering characteristics for both normal mode and common mode
- Epoxy molded for reliability
- Operating temperature: -25°C to +85°C (including temperature rise, see graph on page 63)

### Applications

- Personal computers and peripherals
- Digital equipment
- Industrial equipment
- Vending machines
- Office equipment



### Circuit Diagrams

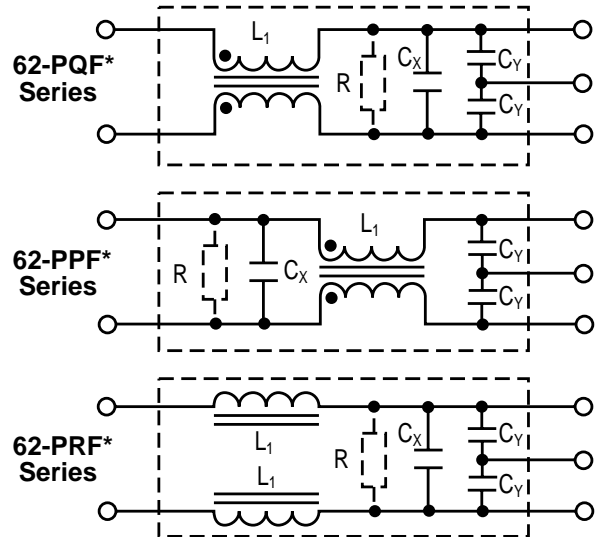

\* Bleeder Resistor is available only for  
62-P(Q/R/P)F-XXX-X-12

### Specifications

Model	Rated Voltage (@ 50/60Hz)	Rated Current	Leakage Current (Max.)	Capacitance		Inductance (L <sub>1</sub> )	Temperature Rise (Max.)				
				C <sub>Y</sub>	C <sub>X</sub>						
62-PQF-020-5-11	250VAC	2A	0.50mA	3300pF	0.1uF	15mH	30°C				
62-PQF-020-5-12					.22uF						
62-PPF-020-5-11					0.1uF			8mH			
62-PPF-020-5-12					.22uF						
62-PQF-030-5-11					0.1uF				2.1mH		
62-PQF-030-5-12					.22uF						
62-PPF-030-5-11		0.1uF			486uH						
62-PPF-030-5-12		.22uF									
62-PQF-060-5-11		0.1uF				181uH					
62-PQF-060-5-12		.22uF									
62-PPF-060-5-11		0.1uF						97uH			
62-PPF-060-5-12		.22uF									
62-PRF-010-5-11		1A			3A				.22uF		
62-PRF-010-5-12		2A									
62-PRF-020-5-11		2A			3A	.22uF					
62-PRF-020-5-12		3A									
62-PRF-030-5-11											
62-PRF-030-5-12											

Note: All types are designed to meet the requirement of UL 1283, CSA 22.2, VDE 0565-3

Test voltage: 1500VAC one minute, line to ground

Insulation resistance: 300 Mohm min. at 500VDC

Voltage drop: 1V max. (except 62-PRF-010-5-11) at rated current

62-PRF-010-5-11: 1.5V max. at rated current

Weight: 62-PPF & PQF Series: 2.11 ounces (60 grams)

62-PRF Series: 1.76 ounces (50 grams)

# Power Line Filters Single Stage

## 62-PPF/PQF/PRF Series

### Temperature Characteristics

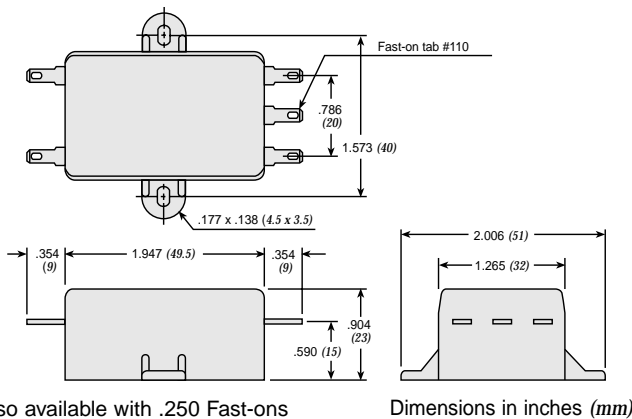
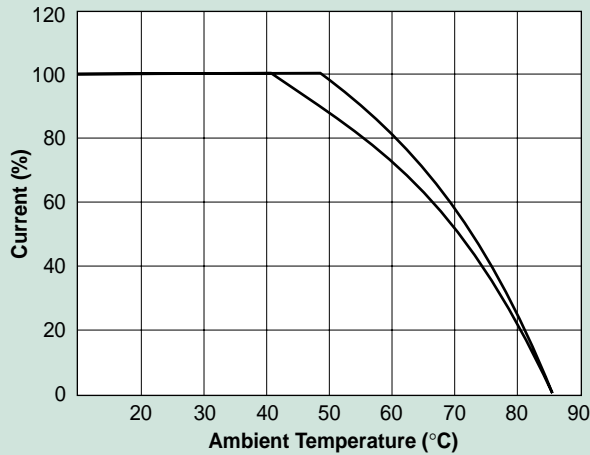

### Normal Mode

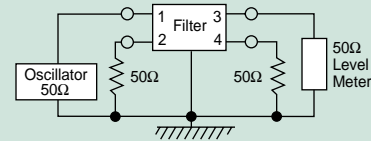

#### 62-PQF Series

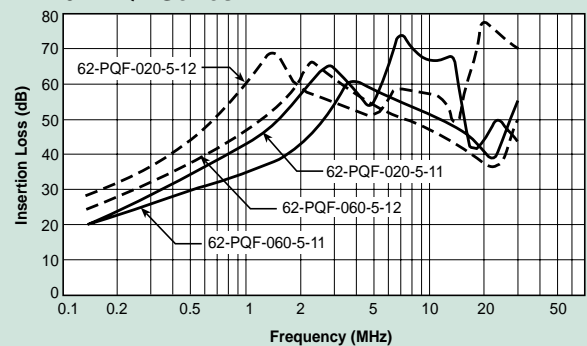

#### 62-PPF Series

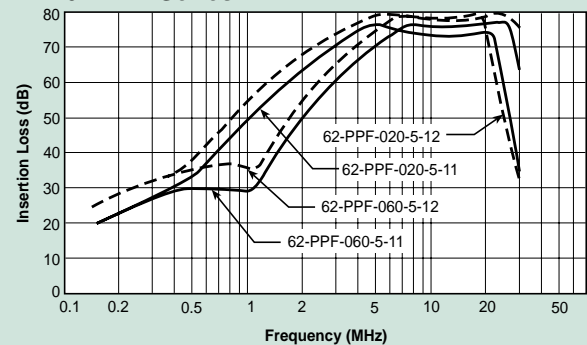

### Common Mode

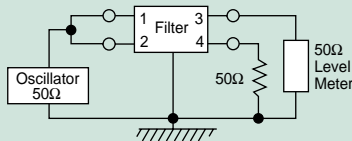

#### 62-P(Q/R)F Series

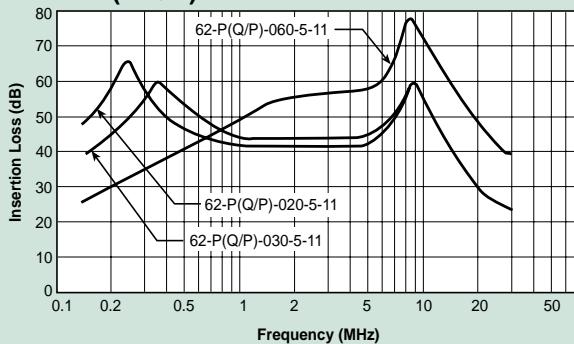

#### 62-PRF Series

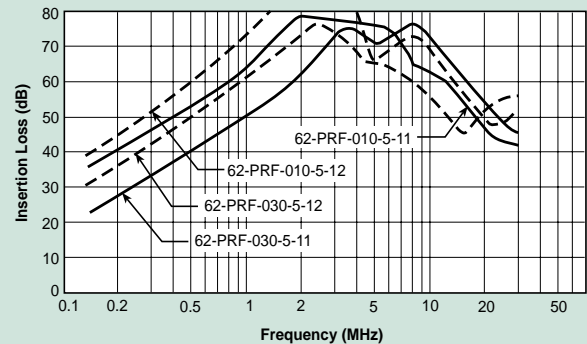

# Power Line Filters Single Stage Wire Leads

## 62-PML Series



Tested and found to be  
IAW VDE 0565 Part 3

### Features

- Compact design requires minimal real estate space
- Suitable for products that must conform to FCC and FTZ regulations
- Excellent attenuation for high voltage impulse
- Metal case provides effective shielding
- Excellent filtering characteristics for both normal mode and common mode
- Structure provides effective shielding for noise generated externally and internally
- Operating temperature: -25°C to +85°C (including temperature rise, see graph on page 65)

### Applications

- Digital equipment
- Personal computers and peripherals
- Measuring instruments
- Medical equipment
- Factory automation equipment



### Circuit Diagram

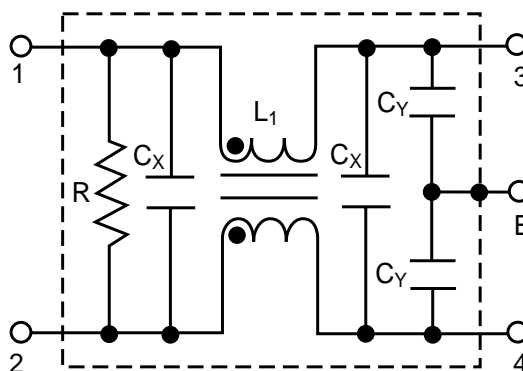

## Specifications

Model	Rated Voltage (@ 50/60Hz)	Rated Current	Leakage Current (Max.)	Capacitance		Inductance (L <sub>1</sub> )	Temperature Rise (Max.)		
				C <sub>Y</sub>	C <sub>X</sub>				
62-PML-015-3-11	250VAC	1.5A	0.35mA	0.1uF		10.0mH	30°C		
62-PML-015-5-11			0.50mA					3300pF	
62-PML-030-3-11		3A	0.35mA			2200pF		4.3mH	
62-PML-030-5-11			0.50mA			3300pF			
62-PML-050-3-11		5A	5A			0.35mA		2200pF	2.4mH
62-PML-050-5-11						0.50mA		3300pF	
62-PML-100-5-11		10A	10A			0.50mA		3300pF	2.2mH

Note: All types are designed to meet the requirement of UL 1283, CSA 22.2. VDE 0565-3  
 Test voltage: 1500VAC one minute, line to ground  
 Insulation resistance: 300 Mohm min. at 500VDC  
 Voltage drop: 1V max. at rated current  
 Weight: 62-PML-015 Series: 3.06 ounces (87 grams)  
           62-PML-030 Series: 3.17 ounces (90 grams)  
           62-PML-050 Series: 3.28 ounces (93 grams)  
 Discharge time: 0.4 sec. max.

# Power Line Filters Single Stage Wire Leads

## 62-PML Series

### Temperature Characteristics

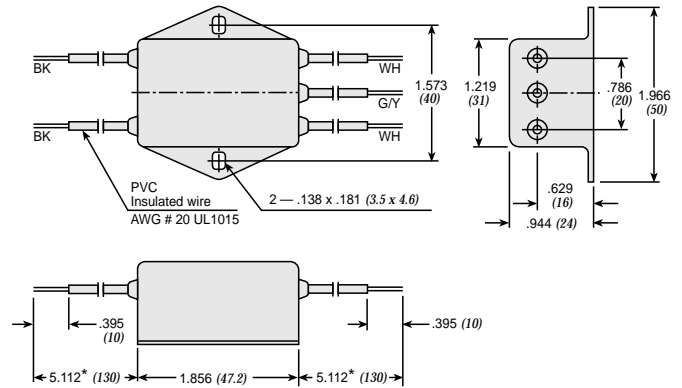
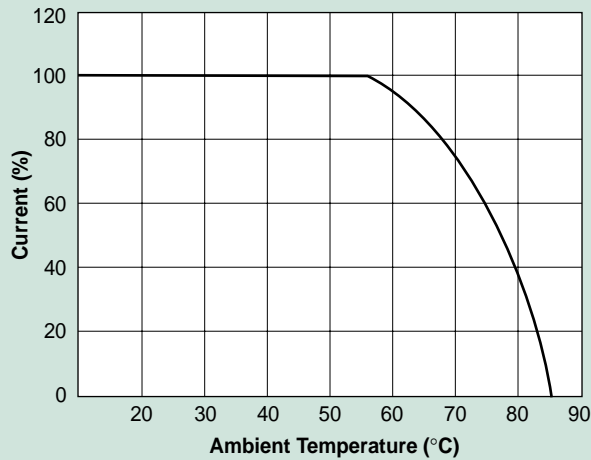

\* Custom lengths available upon request. Dimensions in inches (mm)

### Common Mode

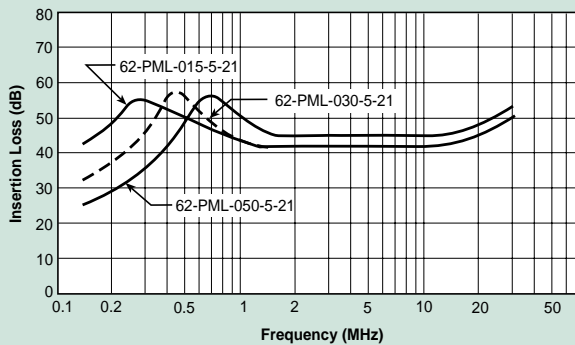
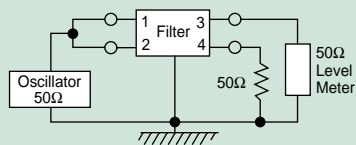

### Normal Mode

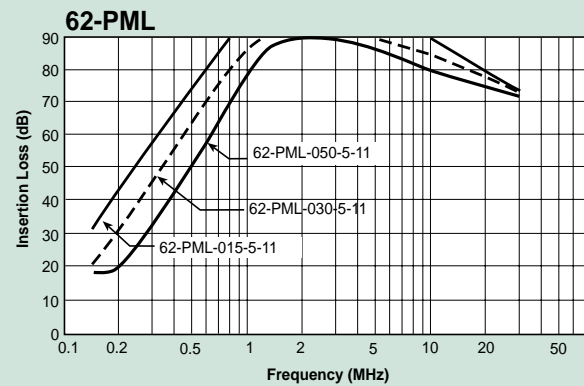
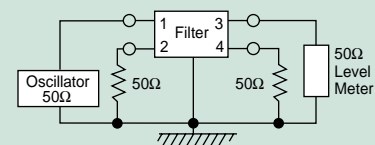

# Power Line Filters

## Single Stage Wire Leads

for Medical Purpose Applications

### 12-PML & 12-PMF Series



#### Features

- Compact design requires minimal real estate space
- Suitable for products that must conform to FCC and FTZ regulations
- Excellent attenuation for high voltage impulse
- Metal case provides effective shielding
- Excellent filtering characteristics for both normal mode and common mode
- Structure provides effective shielding for noise generated externally and internally
- Operating temperature: -25°C to +70°C
- Low leakage current

#### Applications

- Digital equipment
- Personal computers and peripherals
- Measuring instruments
- Medical equipment
- Factory automation equipment



#### Circuit Diagram

Circuit 1

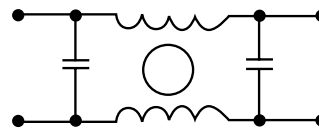

Circuit 2

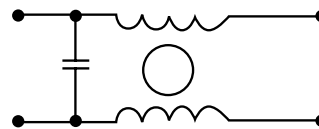

#### Specifications

Model	Rated Voltage (@ 50/60Hz)	Rated Current	Leakage Current (Max.)	Circuit Diagram	Figure	Temperature Rise (Max.)
12-PML-001-2-A	120/250VAC	1A	5uA	1	A	30°C
12-PML-002-2-A		2A				
12-PML-006-2-A		6A				
12-PML-010-2-A		10A				
12-PMF-001-2-B		1A		2	B	
12-PMF-002-2-B		2A				
12-PMF-006-2-B		6A				
12-PML-001-2-C				1A		

Note: All types are designed to meet the requirement of UL 1283, CSA 22.2. VDE 0565-3  
 Test voltage: 1500VAC one minute, line to ground  
 Insulation resistance: 300 Mohm min. at 500VDC  
 Voltage drop: 1V max. at rated current  
 Discharge time: 0.4 sec. max.

# Power Line Filters

## Single Stage Wire Leads

for Medical Purpose Applications

### 12-PML & 12-PMF Series

Figure A

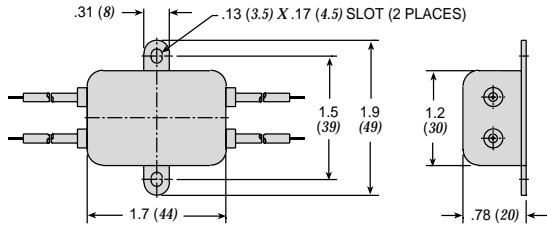

Figure C

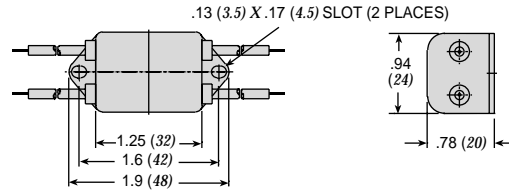
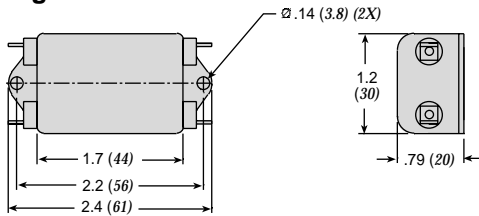
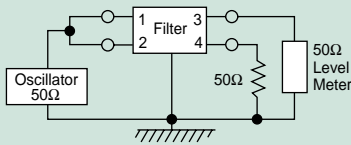

Figure B



Dimensions in inches (mm)

#### Common Mode



#### 12-PML-001;-002;-006;-010

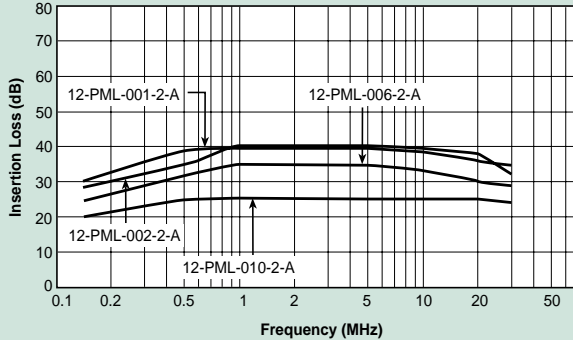

#### 12-PMF-001;-002;-006;-010

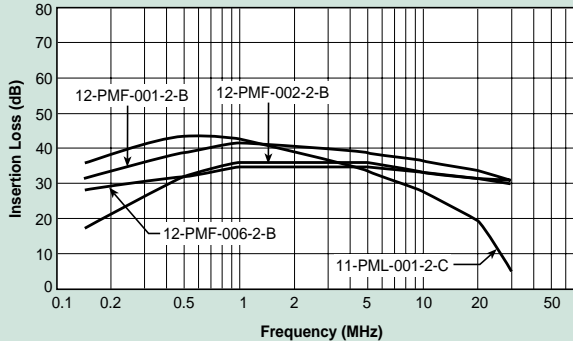

#### Normal Mode

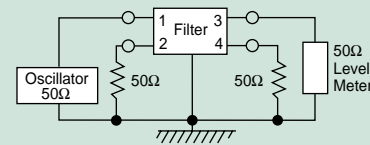

#### 12-PML-001;-002;-006;-010

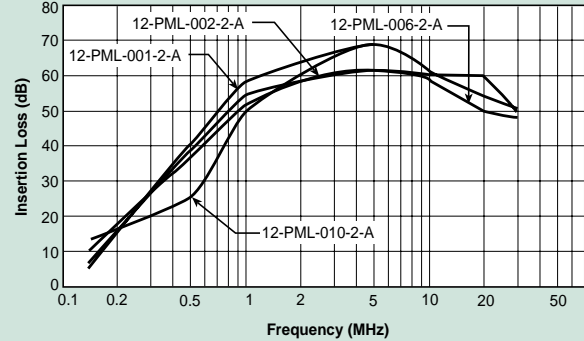

#### 12-PMF-001;-002;-006;-010

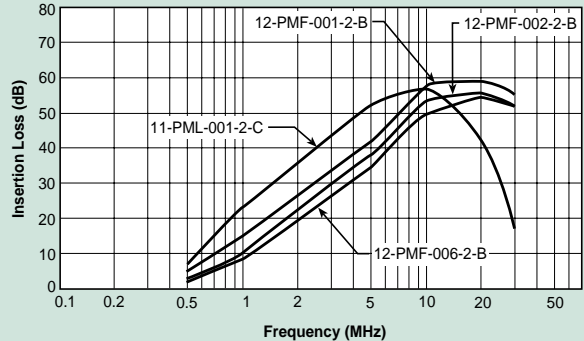



# Power Line Filters Single Stage

## 62-LMF & LMB Series



Tested and found to be  
IAW VDE 0565 Part 3

### Features

- Space saving, compact designs
- Suitable for products that must conform to FCC and FTZ regulations
- Excellent filtering characteristics for both normal mode and common mode
- Structure provides effective shielding for noise generated externally and internally
- Metal case provides effective shielding
- Rugged construction
- Operating temperature: -25°C to +85°C (including temperature rise, see graph on page 69)

### Applications

- Digital equipment
- Office automation equipment, such as copy and fax machines
- Computers and peripherals
- Instrumentation and controls



### Circuit Diagram

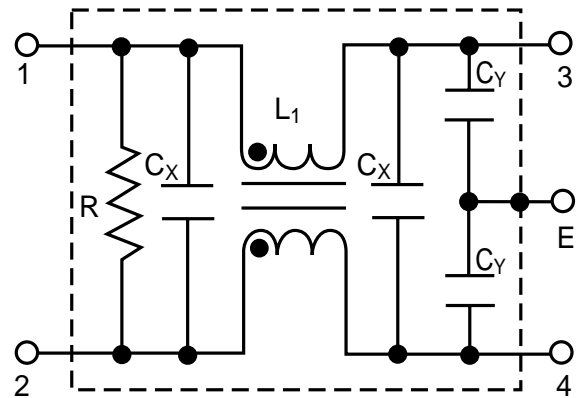

## Specifications

Model*	Rated Voltage (@ 50/60Hz)	Rated Current	Leakage Current (Max.)	Capacitance		Inductance (L <sub>1</sub> )	Temperature Rise (Max.)	
				C <sub>Y</sub>	C <sub>X</sub>			
62-LMB-030-5-11	250VAC	3A	0.50mA	3300pF	0.1uF	14mH	45°C	
62-LMF-030-5-11		5A			0.1uF & .22uF	7.0mH		
62-LMB-050-5-11					8A	.22uF		4.2mH
62-LMF-050-5-11		10A				.33uF		2.2mH
62-LMB-080-5-11					.33uF	2.2mH		2.2mH
62-LMF-080-5-11								
62-LMB-100-5-11					.33uF	2.2mH		2.2mH
62-LMF-100-5-11		.33uF						

Note: Test voltage: 1500VAC one minute, line to ground  
 Insulation resistance: 300 Mohm min. at 500VDC  
 Voltage drop: 1V max. at rated current  
 Discharge time: 0.4 sec. max.  
 Weight: 5.3 ounces (150 grams)

\*62-LMF - designates Fast-on terminals  
 62-LMB - designates Bolt-in terminals  
 62-LML - wire lead in/outputs also available

# Power Line Filters Single Stage

## 62-LMF & LMB Series

### Temperature Characteristics

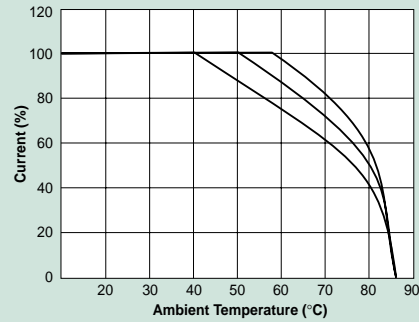

### 62-LMB

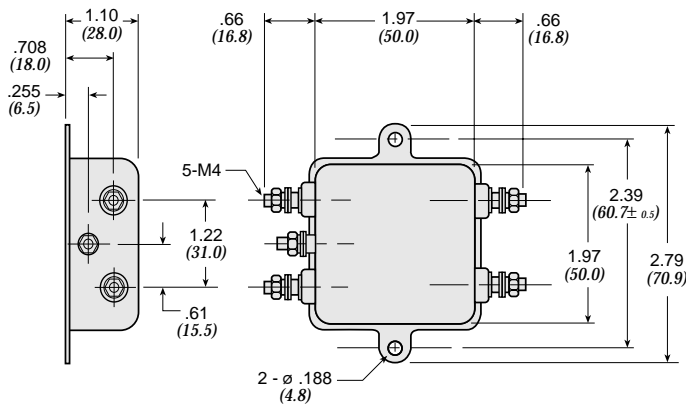

### 62-LMF

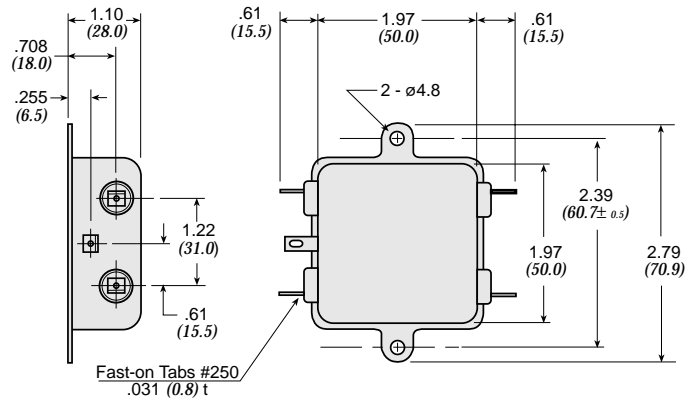

Dimensions in inches (mm)

### Common Mode

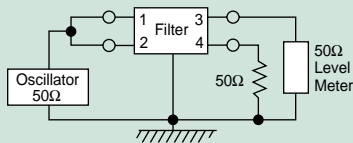

### Normal Mode

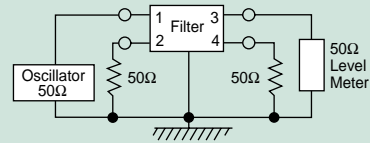

### 62-LMF & LMB

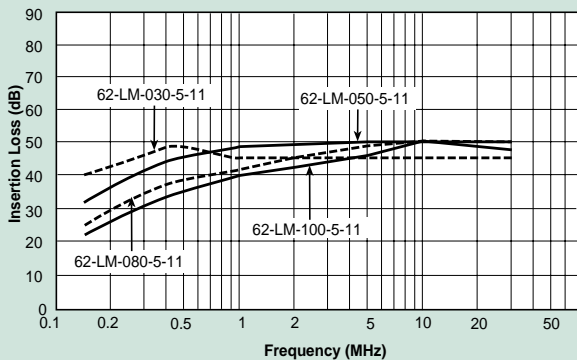

### 62-LMF & LMB

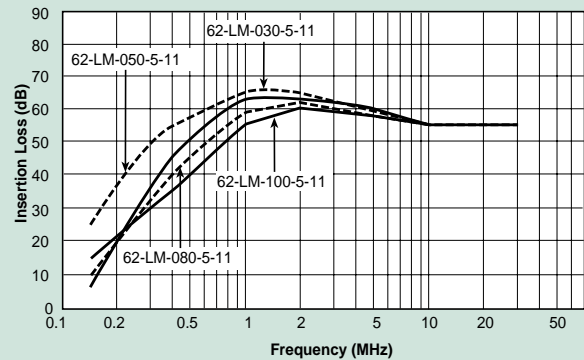

# Power Line Filters Single Stage

## 62-PMF & PMB Series



Tested and found to be  
IAW VDE 0565 Part 3

### Features

- Space-saving, compact designs
- Suitable for products that must conform to FCC regulations
- Excellent attenuation for high voltage impulse
- Metal case provides effective EMI shielding
- Excellent filtering characteristics for both normal mode and common mode
- Epoxy molded for internal component reliability
- Structure provides effective shielding for noise generated externally and internally
- Operating temperature: -25°C to +85°C (including temperature rise, see graph on page 71)

### Applications

- Digital equipment
- Computers and peripherals
- Measuring instruments
- Medical equipment
- Equipment requiring very high impulse attenuation
- Factory automation equipment
- Industrial equipment such as UPS, inverters and converters
- Telecommunications equipment
- Office automation equipment, such as copy and fax machines



### Circuit Diagram

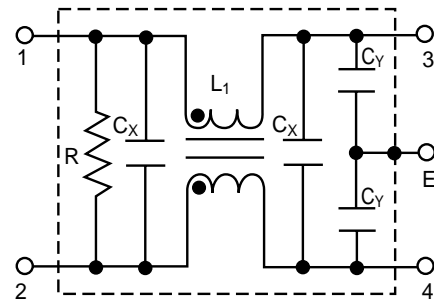

### Specifications

Model*	Rated Voltage (@ 50/60Hz)	Rated Current	Leakage Current (Max.)	Capacitance		Inductance (L <sub>1</sub> )	Temperature Rise (Max.)	
				C <sub>Y</sub>	C <sub>X</sub>			
62-PMB-050-5-11	250VAC	5A	0.50mA	3300pF	0.1uF	14mH	30°C	
62-PMF-050-5-11								
62-PMB-080-5-11		8A			.1uF & .22uF	7.0mH		
62-PMF-080-5-11								
62-PMB-100-5-12		10A			.22uF	4.2mH		
62-PMF-100-5-12								
62-PMB-150-5-13		15A			.33uF	2.2mH		35°C
62-PMF-150-5-13								
62-PMB-200-5-13		20A			1.8mH	1.8mH		45°C**
62-PMF-200-5-13								

Note: Test voltage: 1500VAC one minute, line to ground  
 Insulation resistance: 300 Mohm min. at 500VDC  
 Voltage drop: 1V max.  
 Discharge time: 0.4 sec. max.  
 Weight: 8.82 ounces ( 250 grams)

\* PMF - designates Fast-on terminals  
 PMB - designates Bolt-in terminals

\*\* The temperature rise of 20 amp units can be decreased to 30°C by mounting on 200 X 200 x 1.0(mm) steel chassis

# Power Line Filters Single Stage

## 62-PMF & PMB Series

### Temperature Characteristics

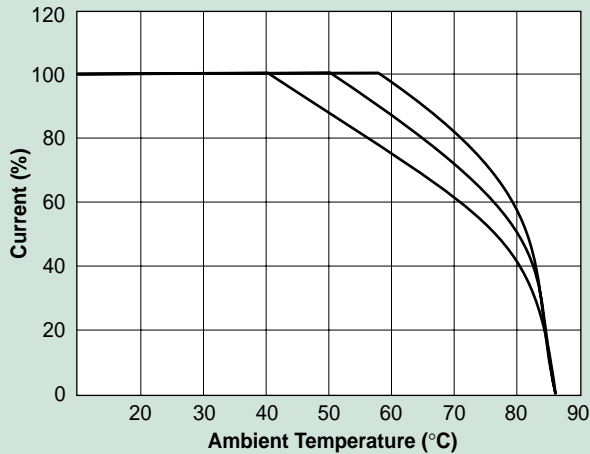

### 62-PMF

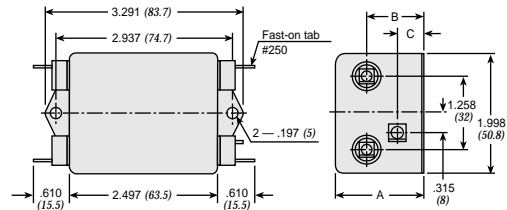

### 62-PMB

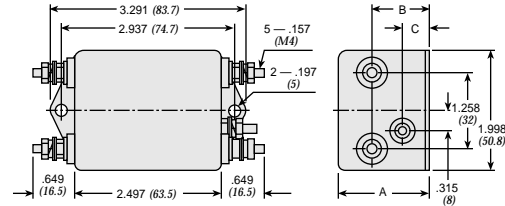

MODEL	A	B	C
62-PMF/PMB-100-200	1.490 (38)	.944 (24)	.433 (11)
62-PMF/PMB-050-080	1.258 (32)	.786 (20)	0 (0)

Dimensions in inches (mm)

### Common Mode

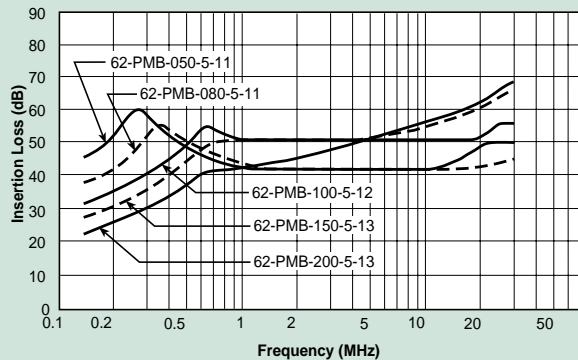
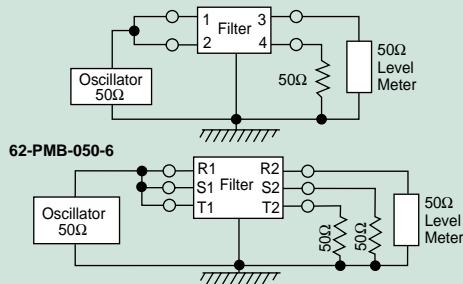

### Normal Mode

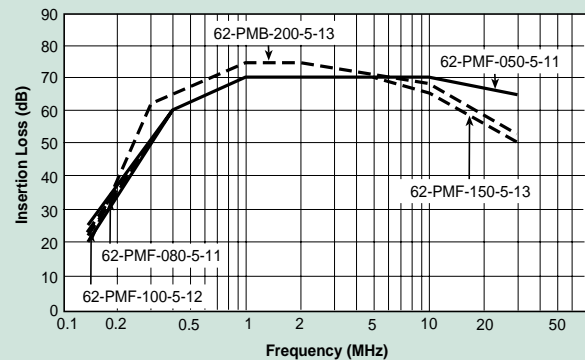
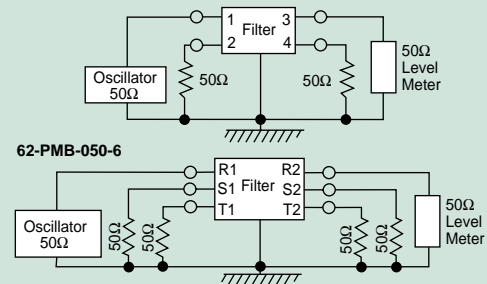

# Power Line Filters Single Stage

## 12-PMF Series



### Features

- Space-saving, compact designs
- Suitable for products that must conform to FCC regulations
- Excellent attenuation for high voltage impulse
- Metal case provides effective EMI shielding
- Excellent filtering characteristics for both normal mode and common mode
- Epoxy molded for internal component reliability
- Structure provides effective shielding for noise generated externally and internally
- Operating temperature: -40°C to +85°C

### Applications

- Digital equipment
- Computers and peripherals
- Measuring instruments
- Medical equipment
- Equipment requiring very high impulse attenuation
- Factory automation equipment
- Industrial equipment such as UPS, inverters and converters
- Telecommunications equipment
- Office automation equipment, such as copy and fax machines

### Specifications

Model	Rated Voltage (@ 50/60Hz)	Rated Current	Leakage Current (Max.)	Circuit Diagram	Figure	Temperature Rise (Max.)
12-PMF-001-5-A	120/250VAC	1A	0.5mA	1	A	30°C
12-PMF-002-5-B		2A		2	B	
12-PMF-003-5-A		3A		4	A	
12-PMF-003-5-B		2		B		
12-PMF-006-5-A		6A		4	A	
12-PMF-006-5-C		1		C		
12-PMF-006-5-D		6		D		
12-PMF-010-5-A		10A		2	A	
12-PMF-010-5-C		3		C		
12-PMF-015-5-C		15A		5	E	
12-PMF-015-5-E		C				
12-PMF-020-5-C		20A			D	
12-PMF-020-5-D		D				
12-PMF-020-5-E		E				

Note: Test voltage: 1500VAC one minute, line to ground  
 Insulation resistance: 300 Mohm min. at 500VDC  
 Voltage drop: 1V max.  
 Discharge time: 0.4 sec. max.



### Circuit Diagram

Circuit 1

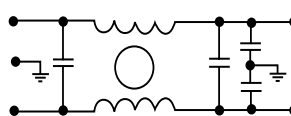

Circuit 2

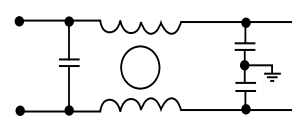

Circuit 3

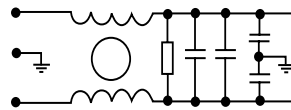

Circuit 4

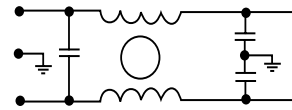

Circuit 5

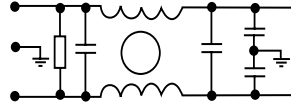

Circuit 6

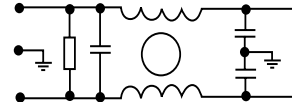

# Power Line Filters Single Stage

## 12-PMF Series

Figure A

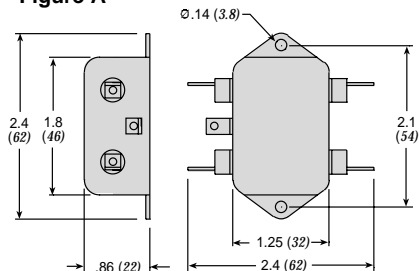

Figure B

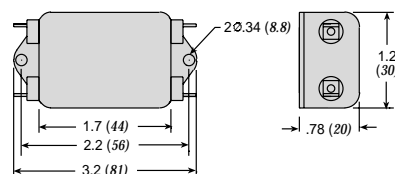

Figure C

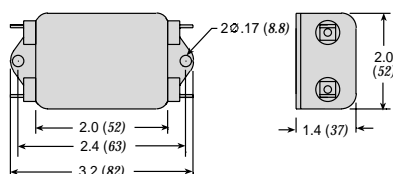

Figure D

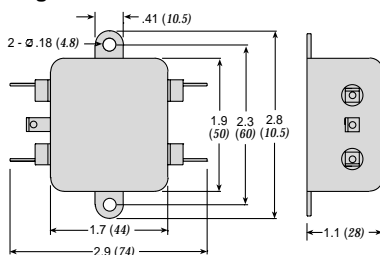
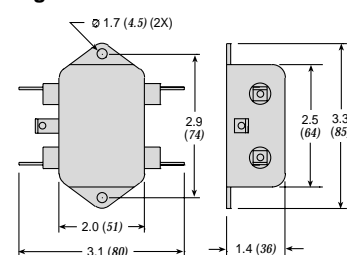
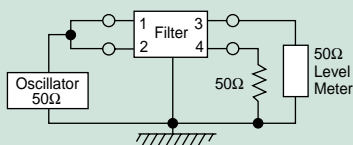

Figure E



Dimensions in inches (mm)

### Common Mode



#### 12-PMF-001;-002;-003;-006

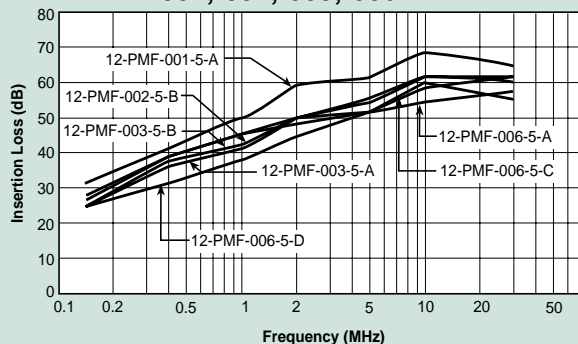

#### 12-PMF-001;-002;-003;-006

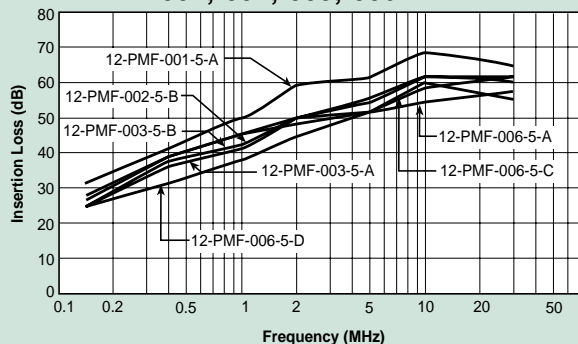

### Normal Mode

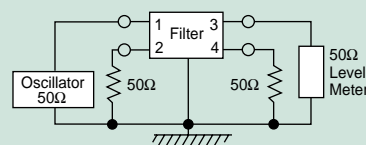

#### 12-PMF-001;-002;-003;-006

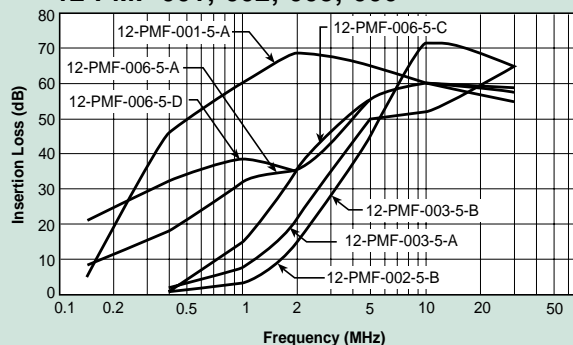

#### 12-PMF-010;-015;-020

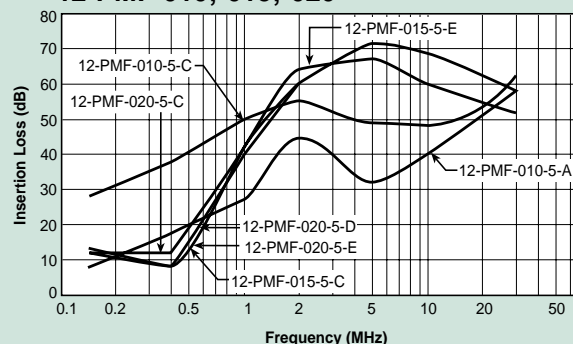

# Power Line Filters Single Stage - Higher Current



## 62-PMB Series

### Features

- Space-saving, compact designs
- Suitable for products that must conform to FCC regulations
- Excellent attenuation for high voltage impulse
- Metal case provides effective shielding
- Excellent filtering characteristics for both normal mode and common mode
- Epoxy molded for internal component reliability
- Structure provides effective shielding for noise generated externally and internally
- Safety agency approvals pending
- Designed to be in accordance with VDE 0565 Part 3
- Operating temperature: -25°C to +85°C (including temperature rise)

### Applications

- Digital equipment
- Computers and peripherals
- Measuring instruments
- Medical equipment
- Equipment requiring very high impulse attenuation
- Factory automation equipment
- Industrial equipment such as UPS, inverters and converters
- Telecommunications equipment
- Office automation equipment, such as copy and fax machines

### Circuit Diagram

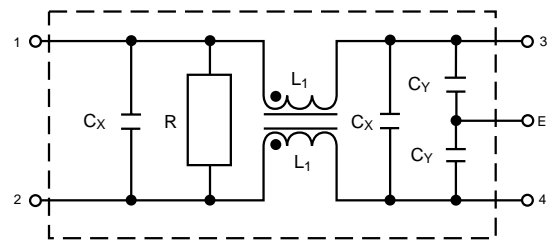

## Specifications

Model	Rated Voltage (@ 50/60Hz)	Rated Current	Leakage Current (Max.)	Capacitance		Inductance (L <sub>1</sub> )	Temperature Rise (Max.)
				C <sub>Y</sub>	C <sub>X</sub>		
62-PMB-300-5-14	250VAC	30A	0.50mA	3300pF	.47uF	1.6mH	45°C
62-PMB-400-5-14		40A				0.8mH	

Note: Test voltage: 1500VAC one minute, line to earth  
 Insulation resistance: 300 Mohm min. at 500VDC  
 Voltage drop: 1V max.  
 Discharge time: 0.4 sec. max.  
 Weight: 8.82 ounces (250 grams)

# Power Line Filters Single Stage - Higher Current

## 62-PMB Series

62-PMB-300-5-14 and 62-PMB-400-5-14

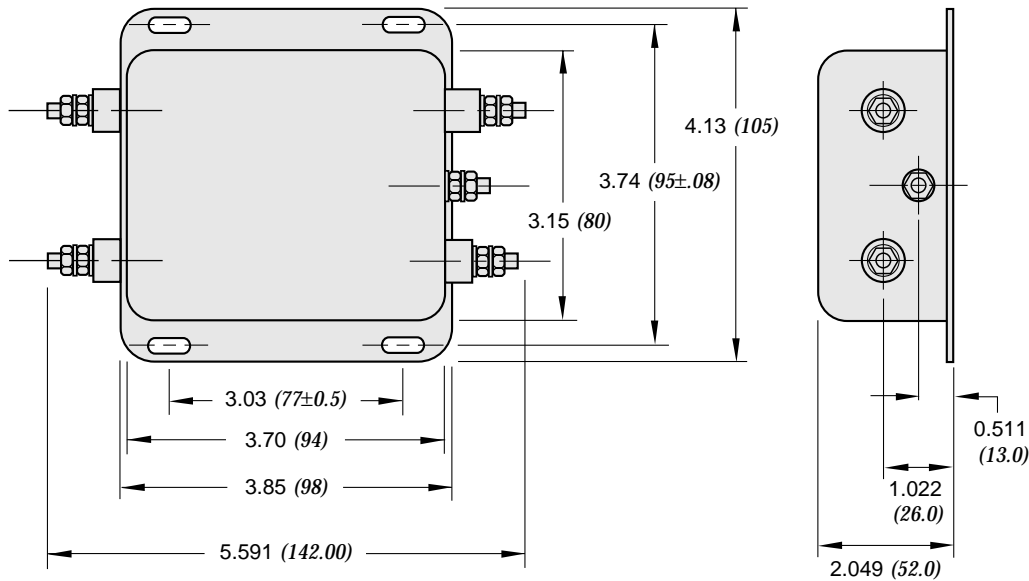

Dimensions in inches (mm)

Power Line Filters

### Normal Mode

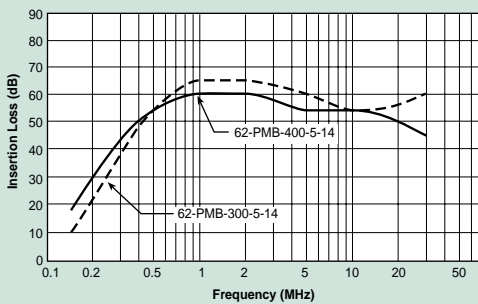
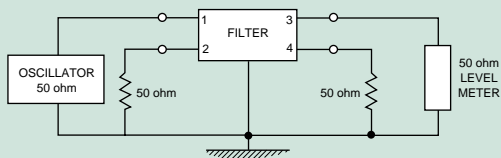

### Common Mode

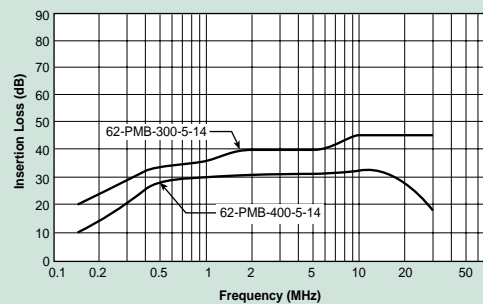
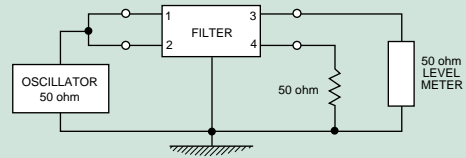



# Power Line Filters Single Stage - Higher Current

## 12-PMB Series

### Features

- Space-saving, compact designs
- Suitable for products that must conform to FCC regulations
- Excellent attenuation for high voltage impulse
- Metal case provides effective shielding
- Excellent filtering characteristics for both normal mode and common mode
- Epoxy molded for internal component reliability
- Structure provides effective shielding for noise generated externally and internally
- Designed to be in accordance with VDE 0565 Part 3
- Operating temperature: -40°C to +85°C

### Applications

- Digital equipment
- Computers and peripherals
- Measuring instruments
- Medical equipment
- Equipment requiring very high impulse attenuation
- Factory automation equipment
- Industrial equipment such as UPS, inverters and converters
- Telecommunications equipment
- Office automation equipment, such as copy and fax machines



### Circuit Diagram

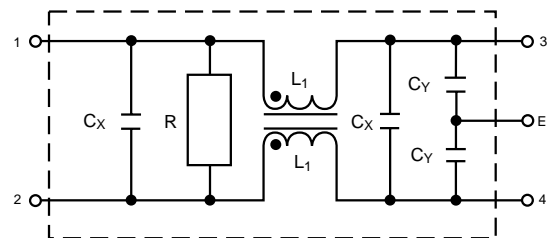

## Specifications

Model	Rated Voltage (@ 50/60Hz)	Rated Current	Leakage Current (Max.)	Circuit Diagram	Figure	Temperature Rise (Max.)
12-PMB-025-5-A	120/250VAC	25A	0.5mA	1	A	30°C
12-PMB-030-5-A		30A				
12-PMB-035-5-B		35A				
12-PMB-050-5-B		50A	1.0mA			
12-PMB-100-8-C		100A				
12-PMB-120-8-C		120A				

Note: Test voltage: 1500VAC one minute, line to earth  
 Insulation resistance: 300 Mohm min. at 500VDC  
 Voltage drop: 1V max.  
 Discharge time: 0.4 sec. max.  
 Weight: 8.82 ounces (250 grams)

# Power Line Filters Single Stage - Higher Current

## 12-PMB Series

Figure A

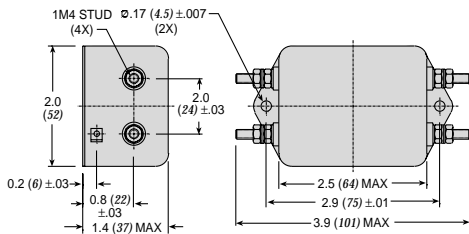

Figure B

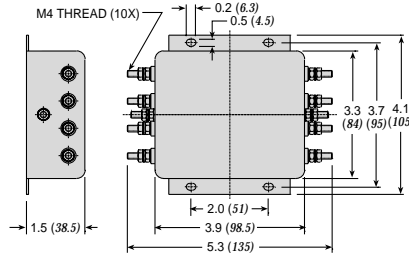
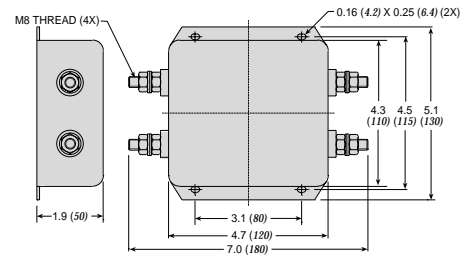
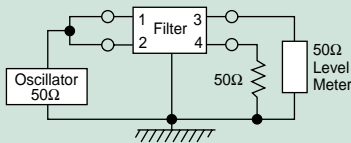

Figure C



Dimensions in inches (mm)

### Common Mode



#### 12-PMB-025;-030;-035

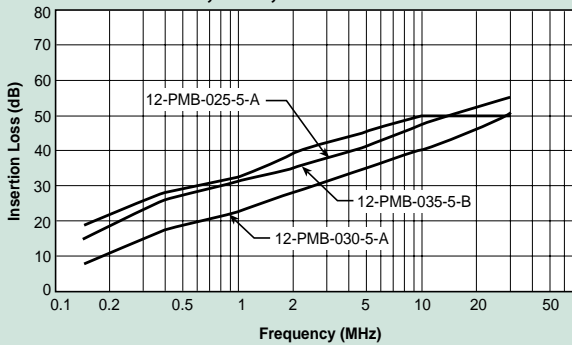

#### 12-PMB-050;-100;-120

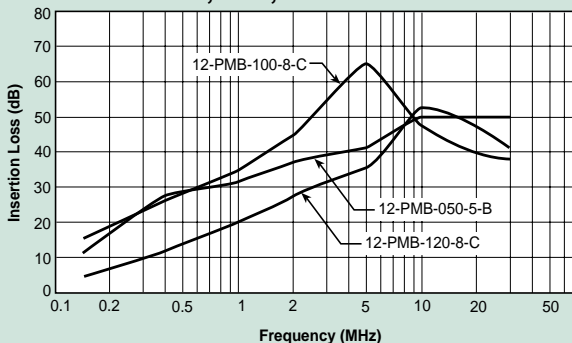

### Normal Mode

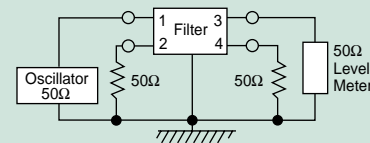

#### 12-PMB-025;-030;-035

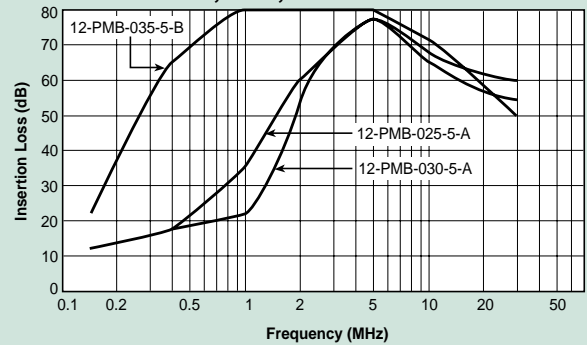

#### 12-PMB-050;-100;-120

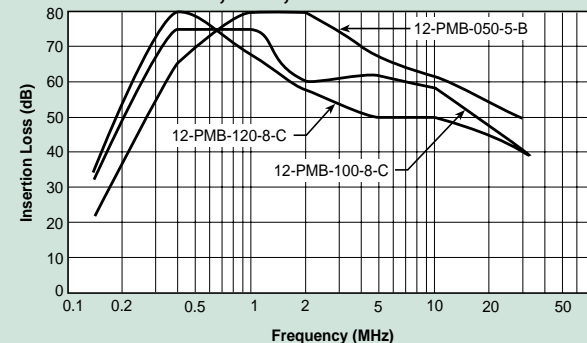

# Power Line Filters DC - Higher Current

## 12-PMF & 12 PMB DC Series

### Features

- Space-saving, compact designs
- Suitable for products that must conform to FCC regulations
- Excellent attenuation for high voltage impulse
- Metal case provides effective shielding
- Excellent filtering characteristics for both normal mode and common mode
- Epoxy molded for internal component reliability
- Structure provides effective shielding for noise generated externally and internally
- Designed to be in accordance with VDE 0565 Part 3
- Operating temperature: -40°C to +85°C

### Applications

- Digital equipment
- Computers and peripherals
- Measuring instruments
- Equipment requiring very high impulse attenuation
- Factory automation equipment
- Industrial equipment such as UPS, inverters and converters
- Telecommunications equipment



### Circuit Diagram

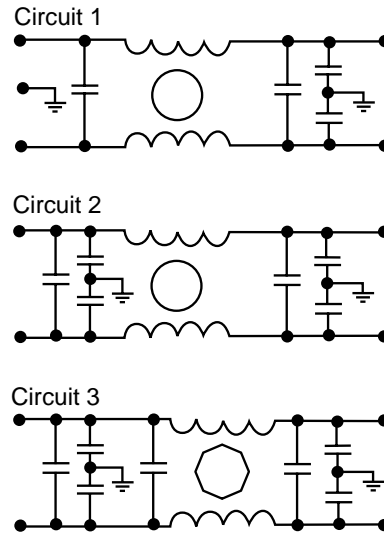

### Specifications

Model	Rated Voltage (@ 50/60Hz)	Rated Current	Circuit Diagram	Figure	Temperature Rise (Max.)
12-PMF-006-DC-C	48/250 VDC	6A	1	A	30°C
12-PMF-010-DC-C		10A			
12-PMF-015-DC-C		15A			
12-PMF-020-DC-C		20A			
12-PMF-025-DC-D		25A			
12-PMB-025-DC-F					
12-PMB-030-DC-F		30A		C	
12-PMB-035-DC-F		35A			
12-PMB-040-DC-F		40A			
12-PMB-040-DC-B		50A		D	
12-PMB-050-DC-B		60A			
12-PMB-060-DC-B		80A	E		
12-PMB-080-DC-G					
12-PMB-080-DC-C		100A	F		
12-PMB-100-DC-C					
12-PMB-120-DC-C					
12-PMB-140-DC-C		140A	G		
12-PMB-180-DC-E		180A			
12-PMB-200-DC-E		200A	2		
12-PMB-260-DC-E		260A			

Note: Test voltage: 1500VAC one minute, line to earth  
Insulation resistance: 300 Mohm min. at 500VDC  
Voltage drop: 1V max.

Discharge time: 0.4 sec. max.  
Weight: 8.82 ounces (250 grams)

# Power Line Filters DC - Higher Current

## 12-PMF & 12-PMB DC Series

Figure B

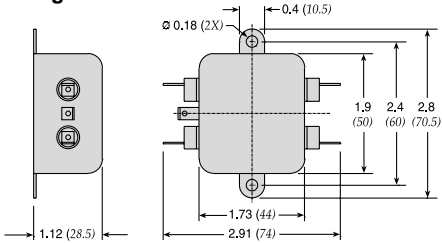

Figure C

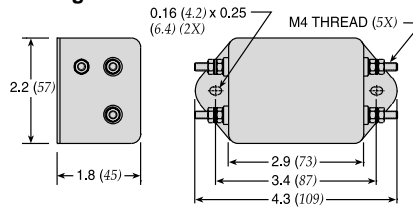

Figure A

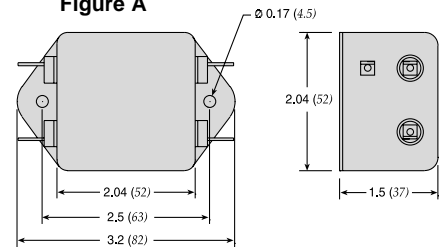

Figure D

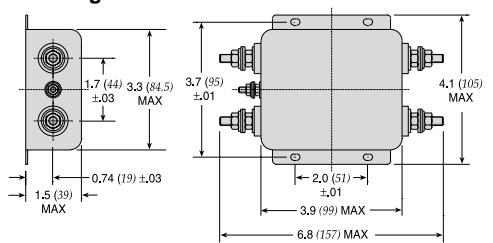

Figure E

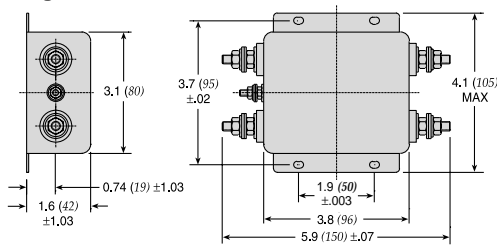

Figure F

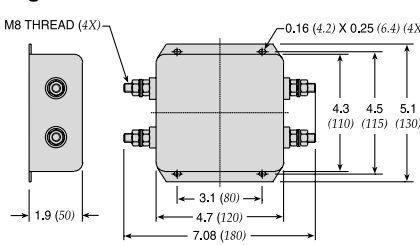
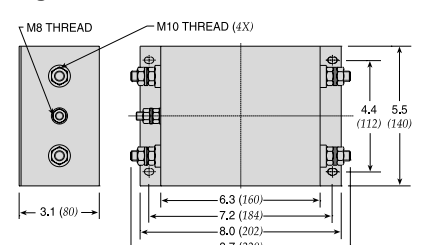
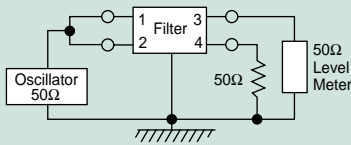

Figure G



Dimensions in inches (mm)

### Common Mode



#### 12-PMF-006;-010;-015;-020;-025

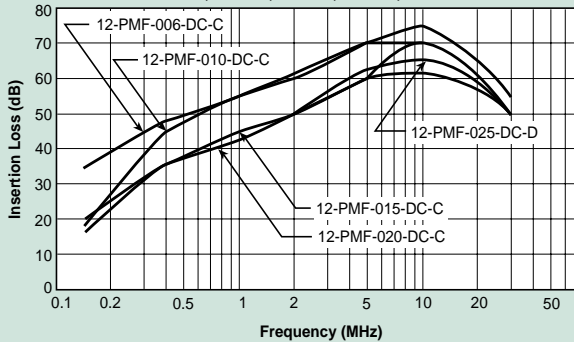

#### 12-PMB-025; thru -260

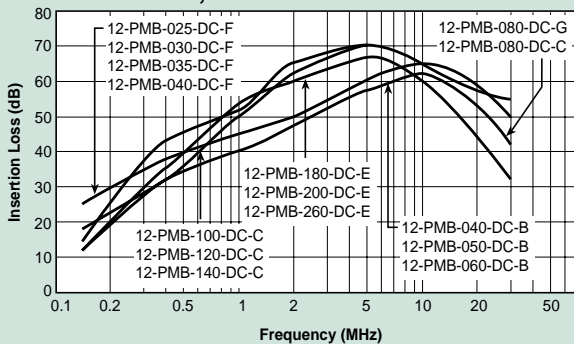

### Normal Mode

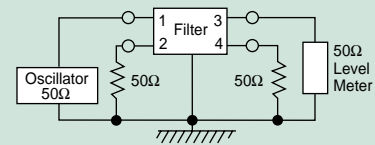

#### 12-PMF-006;-010;-015;-020;-025

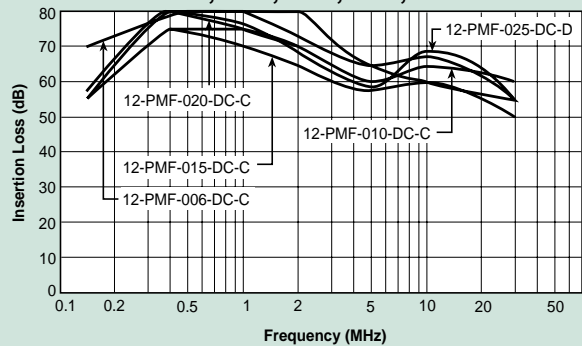

#### 12-PMB-025; thru -260

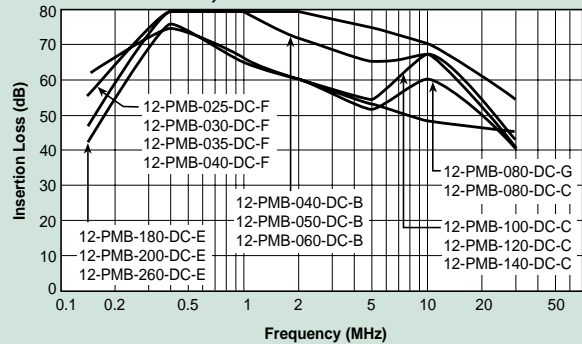

# Power Line Filters Dual Stage

## 62-MMF Series

### Features

- Suitable for products that must conform to FCC regulations
- Excellent attenuation for high voltage impulse
- Metal case provides effective EMI shielding
- Two stages for excellent filtering characteristics
- Epoxy molded for reliability
- Structure provides effective shielding for noise generated both externally and internally
- Operating temperature: -25°C to +85°C (including temperature rise, see graph on page 81)

### Applications

- Digital equipment
- Personal computers and peripherals
- Measuring instruments and medical equipment
- Telecommunications equipment
- Equipment requiring very high noise attenuation



### Circuit Diagram

62-MMF-XXX-7-11

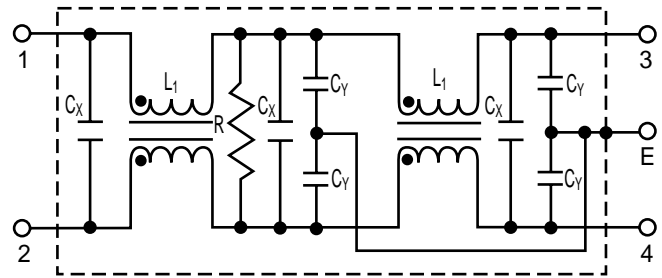

## Specifications

Model	Rated Voltage (@ 50/60Hz)	Rated Current	Leakage Current (Max.)	Capacitance			Inductance (L <sub>1</sub> ) (2X)	Temperature Rise (Max.)
				C <sub>Y1</sub>	C <sub>Y2</sub>	C <sub>X</sub>		
62-MMF-030-7-11	250VAC	3A	.7mA	3300pF	1000pF	0.1uF	3.7mH	30°C
62-MMF-050-7-11	250VAC	5A	.7mA	3300pF	1000pF	0.1uF	2.9mH	30°C

Note: All types are designed to meet the requirement of UL 1283, CSA 22.2, VDE 0565-3  
 Test voltage: 1500VAC one minute, line to ground  
 Insulation resistance: 300 Mohm min. at 500VDC  
 Leakage current: 0.7 mA max.  
 Voltage drop: 1V max.  
 Discharge time: 0.4 sec. max.  
 Weight: 6.0 ounces (170 grams)

# Power Line Filters Dual Stage

## 62-MMF Series

### Temperature Characteristics

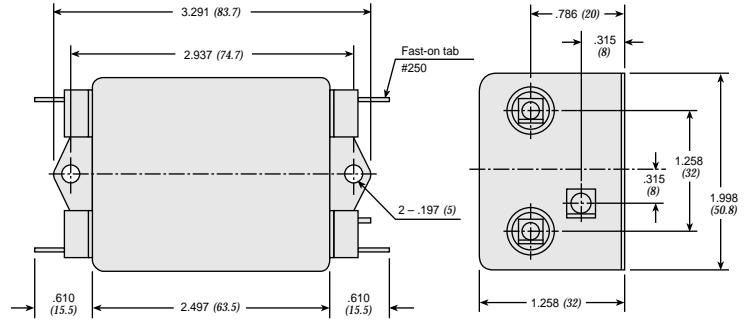
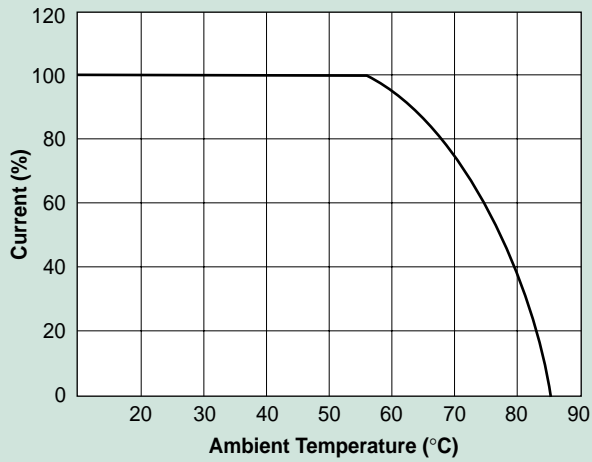

### Common Mode

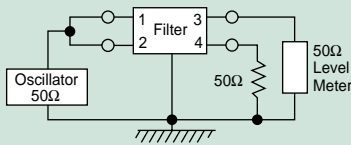

#### 62-MMF

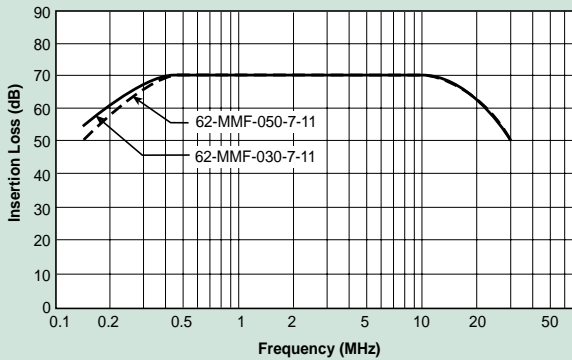

### Normal Mode

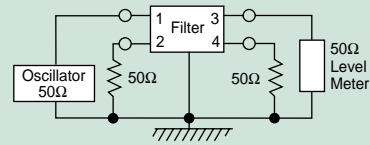

#### 62-MMF

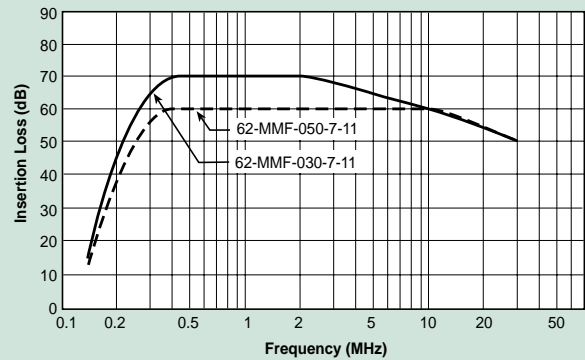

# Power Line Filters Dual Stage

## 12-MMF & 12-MMB Series

### Features

- Suitable for products that must conform to FCC regulations
- Excellent attenuation for high voltage impulse
- Metal case provides effective EMI shielding
- Two stages for excellent filtering characteristics
- Structure provides effective shielding for noise generated both externally and internally
- Operating temperature: -40°C to +85°C
- High performance
- Low leakage current

### Applications

- Digital equipment
- Switching power supplies
- Personal computers and peripherals
- Measuring instruments and medical equipment
- Telecommunications equipment
- Equipment requiring very high noise attenuation



### Circuit Diagram

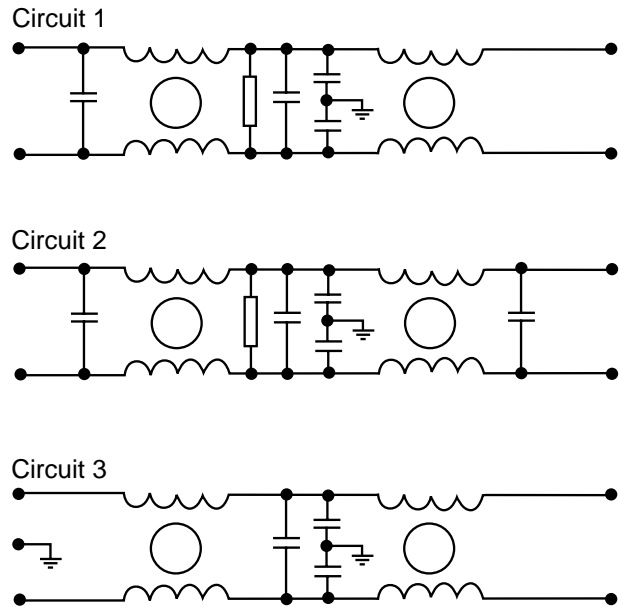

### Specifications

Model	Rated Voltage (@ 50/60Hz)	Rated Current	Leakage Current (Max.)	Circuit Diagram	Figure	Temperature Rise (Max.)
12-MMF-002-5-F	120/250VAC	2A	0.5mA	1	A	30°C
12-MMF-003-5-F		3A			B	
12-MMF-003-5-A					C	
12-MMF-006-5-F		6A		2	B	
12-MMF-006-5-G					D	
12-MMF-008-5-B		8A			B	
12-MMF-010-5-F		10A			D	
12-MMF-010-5-G					B	
12-MMF-010-5-B					D	
12-MMF-012-5-B		12A			E	
12-MMB-015-5-E		15A			D	
12-MMB-020-5-F		20A			F	
12-MMB-030-5-D		30A		G		
12-MMB-050-5-C		50A				

Note: All types are designed to meet the requirement of UL 1283, CSA 22.2, VDE 0565-3  
 Test voltage: 1500VAC one minute, line to ground  
 Insulation resistance: 300 Mohm min. at 500VDC  
 Leakage current: 0.7 mA max.  
 Voltage drop: 1V max.  
 Discharge time: 0.4 sec. max.

# Power Line Filters Dual Stage

## 12-MMF & 12-MMB Series

Figure A

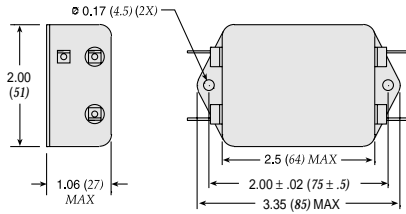

Figure B

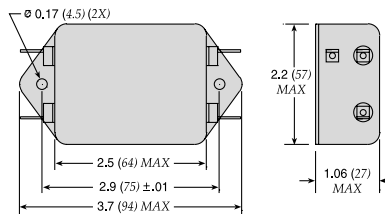

Figure C

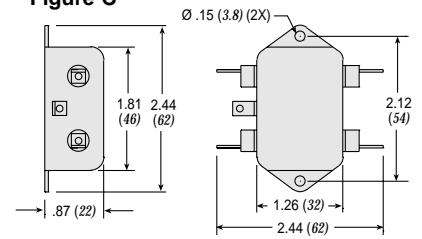

Figure D

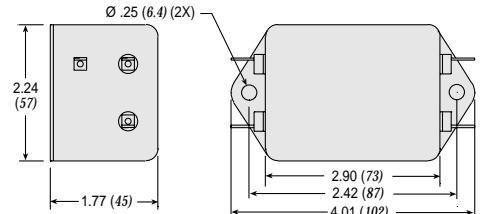

Figure E

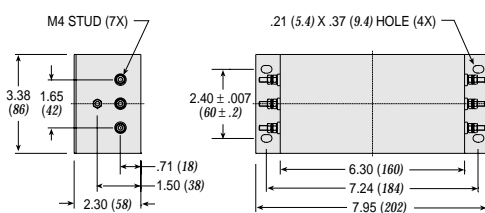

Figure F

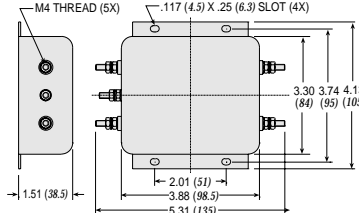
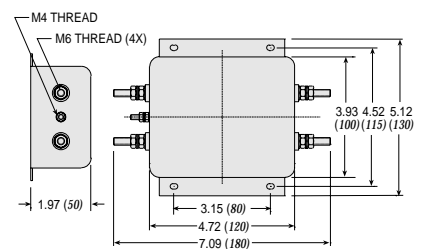
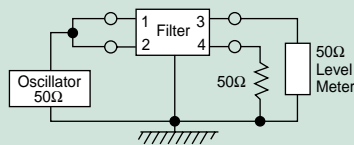

Figure G



Dimensions in inches (mm)

### Common Mode



#### 12-MMF-002;-003;-006;-008

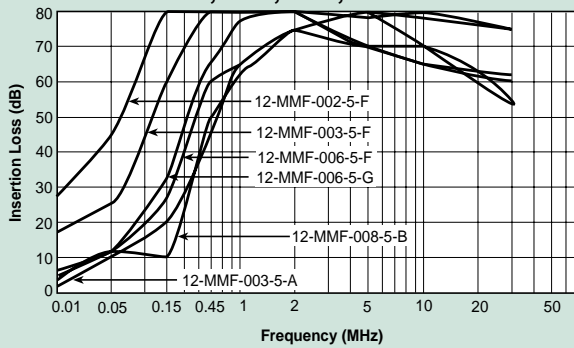

#### 12-MMF-010;-012;-015;-020;-030;-050

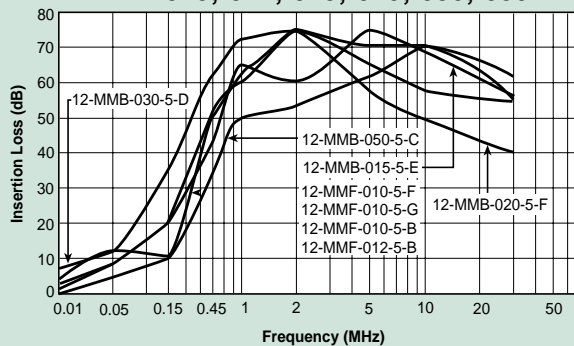

### Normal Mode

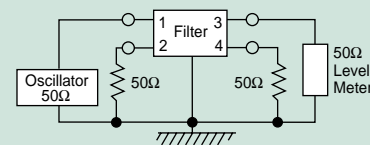

#### 12-MMF-002;-003;-006;-008

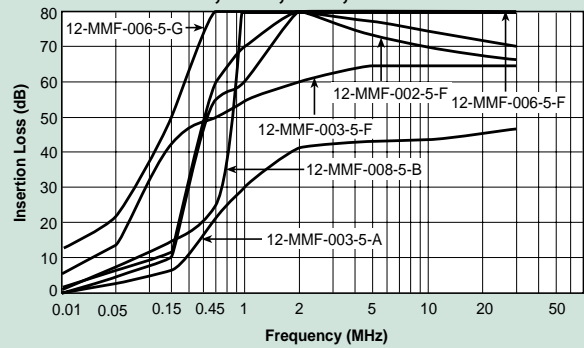

#### 12-MMF-010;-012;-015;-020;-030;-050

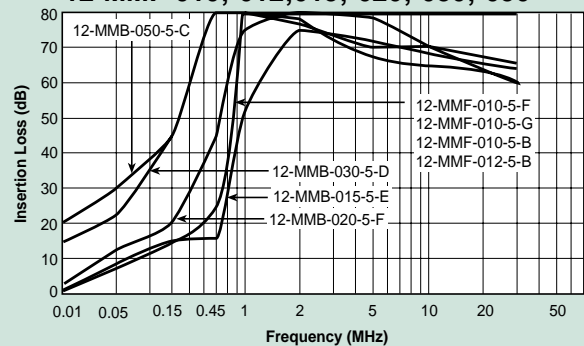



# Power Line Filters Dual Stage

## 12-MMF & 12-MMB Series

### Features

- Suitable for products that must conform to FCC regulations
- Excellent attenuation for high voltage impulse
- Metal case provides effective EMI shielding
- Two stages for excellent filtering characteristics
- Structure provides effective shielding for noise generated both externally and internally
- Operating temperature: -40°C to +85°C
- High performance

### Applications

- Digital equipment
- Personal computers and peripherals
- Measuring instruments and medical equipment
- Telecommunications equipment
- Equipment requiring very high noise attenuation



### Circuit Diagram

Circuit 1

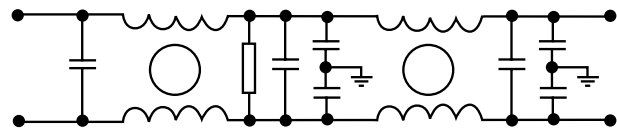

Circuit 2

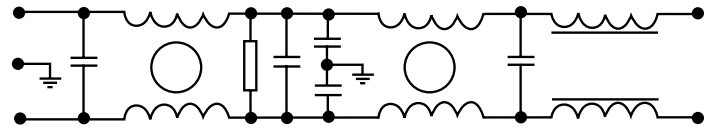

### Specifications

Model	Rated Voltage (@ 50/60Hz)	Rated Current	Leakage Current (Max.)	Circuit Diagram	Figure	Temperature Rise (Max.)
12-MMF-003-11-F	120/250VAC	3A	1.5mA	1	A	30°C
12-MMF-006-11-F		6A			B	
12-MMF-010-11-F		10A			C	
12-MMB-012-11-A		12A		1	B	
12-MMB-015-11-G		15A			D	
12-MMB-020-11-D		20A		2	E	
12-MMB-030-11-D		30A			F	
12-MMB-040-11-B		40A		1		
12-MMB-040-11-E		40A				
12-MMB-050-11-H		50A				

Note: All types are designed to meet the requirement of UL 1283, CSA 22.2. VDE 0565-3  
 Test voltage: 1500VAC one minute, line to ground  
 Insulation resistance: 300 Mohm min. at 500VDC  
 Leakage current: 0.7 mA max.  
 Voltage drop: 1V max.  
 Discharge time: 0.4 sec. max.  
 Weight: 6.0 ounces (170 grams)

# Power Line Filters Dual Stage

## 12-MMF & 12-MMB Series

Figure A

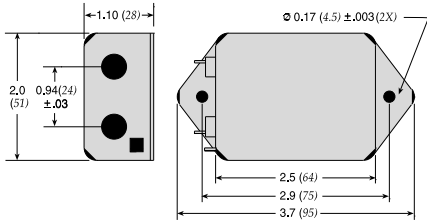

Figure B

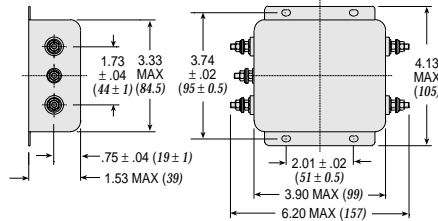

Figure C

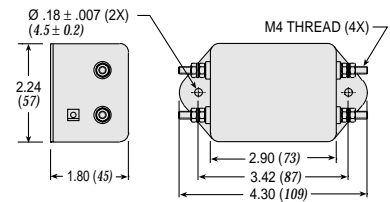

Figure D

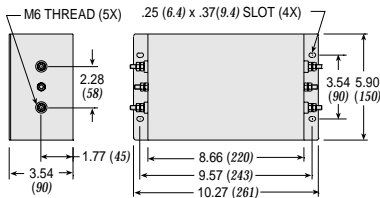

Figure E

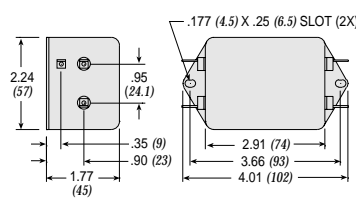
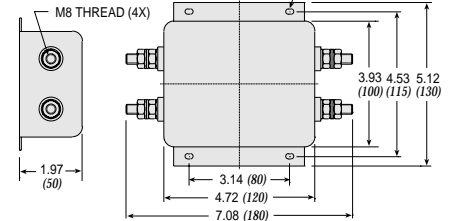
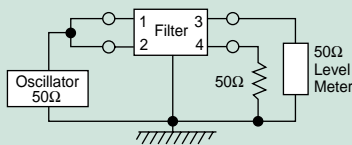

Figure F



Dimensions in inches (mm)

### Common Mode



#### 12-MMF-003;-006;-010;-012;-015

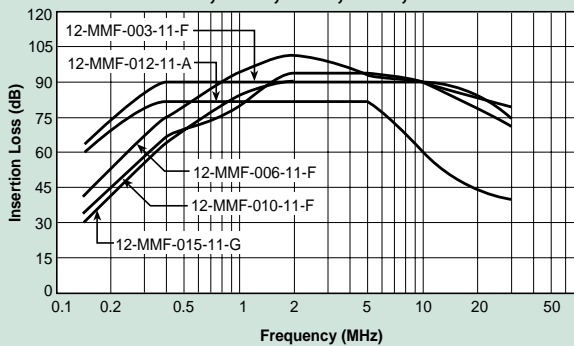

#### 12-MMF-020;-030;-040;-050

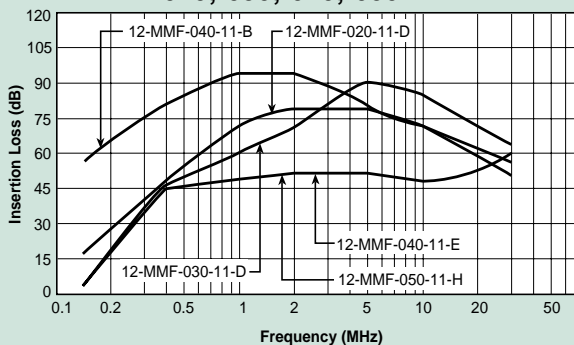

### Normal Mode

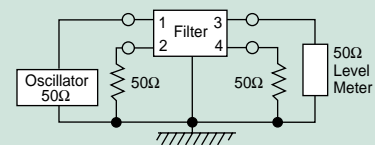

#### 12-MMF-003;-006;-010;-012;-015

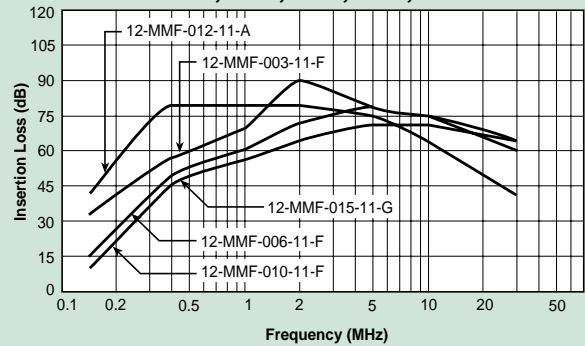

#### 12-MMF-020;-030;-040;-050

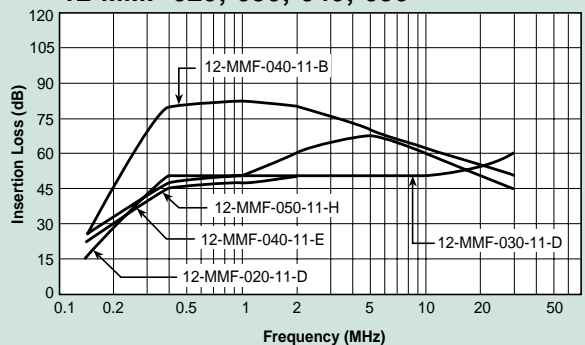

# Power Line Filters Dual Stage

## 12-MMF & 12-MMB Series

### Features

- Suitable for products that must conform to FCC regulations
- Excellent attenuation for high voltage impulse
- Metal case provides effective EMI shielding
- Two stages for excellent filtering characteristics
- Epoxy molded for reliability
- Structure provides effective shielding for noise generated both externally and internally
- Operating temperature: -25°C to +85°C

### Applications

- Digital equipment
- Personal computers and peripherals
- Measuring instruments and medical equipment
- Telecommunications equipment
- Equipment requiring very high noise attenuation



### Circuit Diagram

Circuit 1

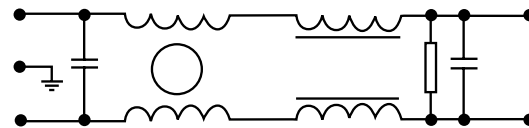

Circuit 2

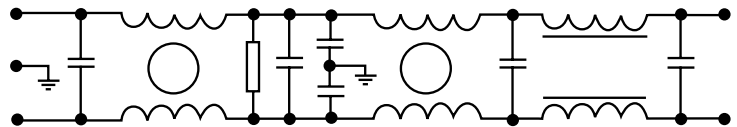

Circuit 3

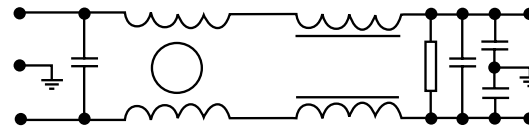

### Specifications

Model	Rated Voltage (@ 50/60Hz)	Rated Current	Leakage Current (Max.)	Circuit Diagram	Figure	Temperature Rise (Max.)	
12-MMF-001-5-F	120/250VAC	1A	0.5mA	3	A	30°C	
12-MMF-003-5-G		3A			5uA		1
12-MMF-003-2-G			6A				
12-MMF-006-5-G		10A	D				
12-MMB-010-5-D		15A					
12-MMB-015-5-E		20A					
12-MMB-020-5-E		30A					
12-MMB-030-5-E							

Note: All types are designed to meet the requirement of UL 1283, CSA 22.2. VDE 0565-3

Test voltage: 1500VAC one minute, line to ground

Insulation resistance: 300 Mohm min. at 500VDC

Leakage current: 0.7 mA max.

Voltage drop: 1V max.

Discharge time: 0.4 sec. max.

Weight: 6.0 ounces (170 grams)

# Power Line Filters Dual Stage

## 12-MMF & 12-MMB Series

Figure A

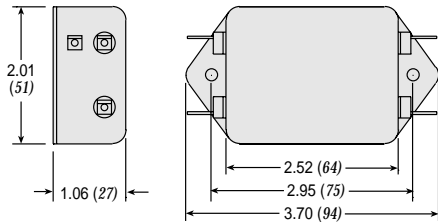

Figure B

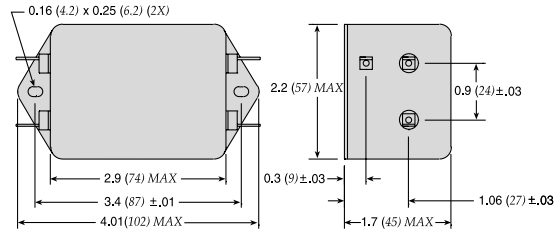

Figure C

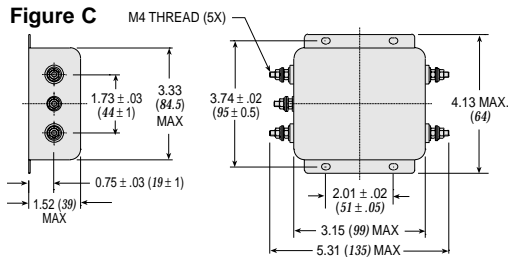
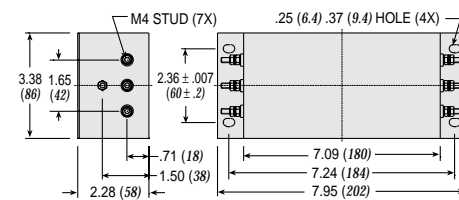
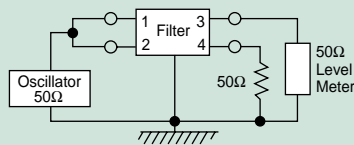

Figure D



Dimensions in inches (mm)

### Common Mode



#### 12-MMF-001;-003;-006

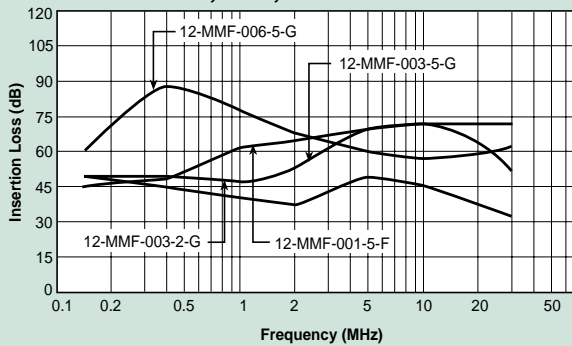

#### 12-MMB-010;-015;-020;-030

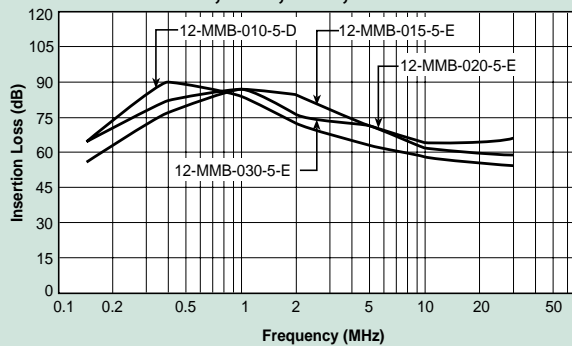

### Normal Mode

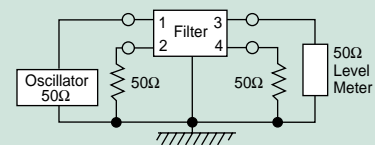

#### 12-MMF-001;-003;-006

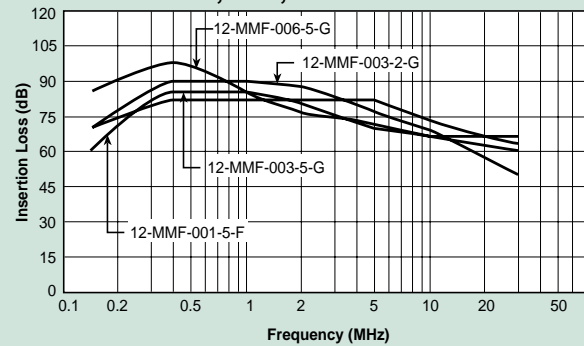

#### 12-MMB-010;-015;-020;-030

