

| LOC |     | DIST             |           | REVISIONS |      |  |  |
|-----|-----|------------------|-----------|-----------|------|--|--|
| P   | LTR | DESCRIPTION      | DATE      | DWN       | APVD |  |  |
| A   |     | RELEASED DRAWING | 04FEB2013 | T.W       | YH.M |  |  |
| A2  |     | ECR-13-005295    | 26MAR2013 | T.W       | YH.M |  |  |

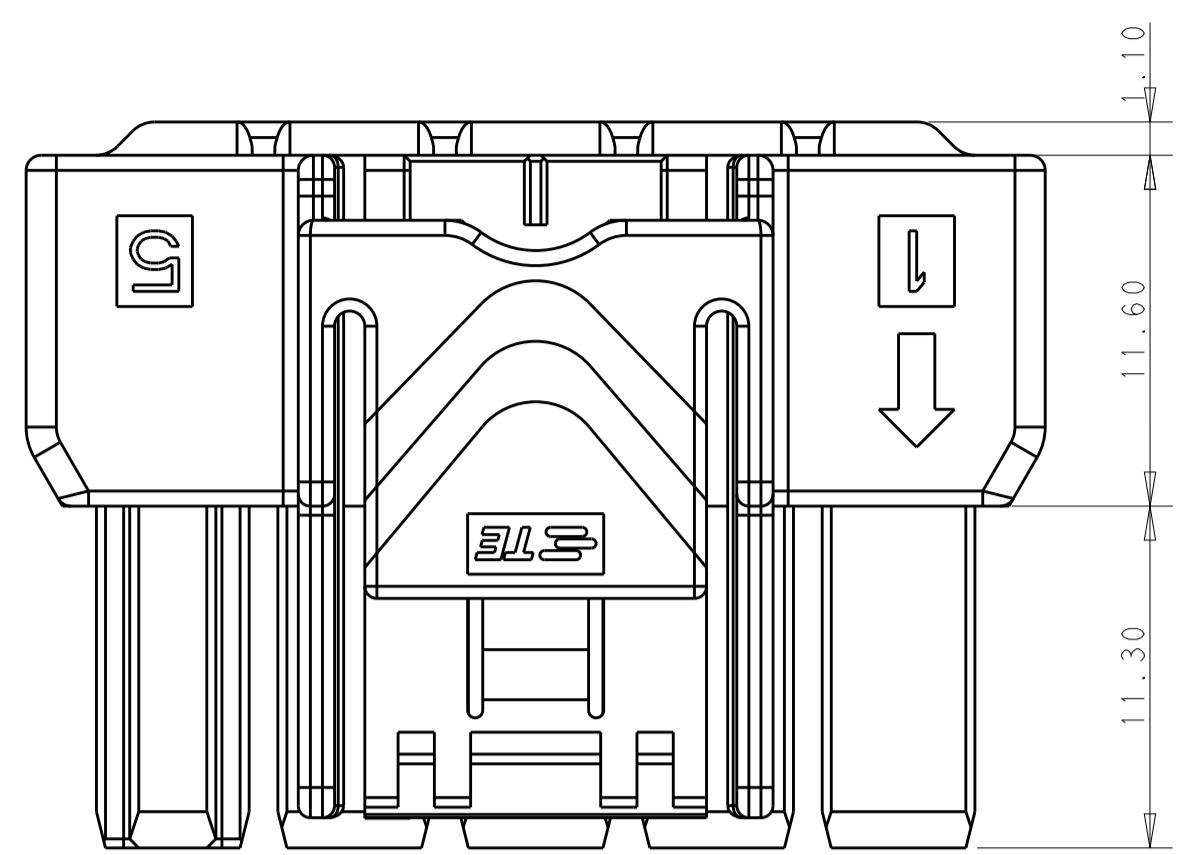

| POS. | DIM. A |
|------|--------|
| 3*5  | 33.70  |
| 3*4  | 27.70  |
| 3*3  | 21.70  |

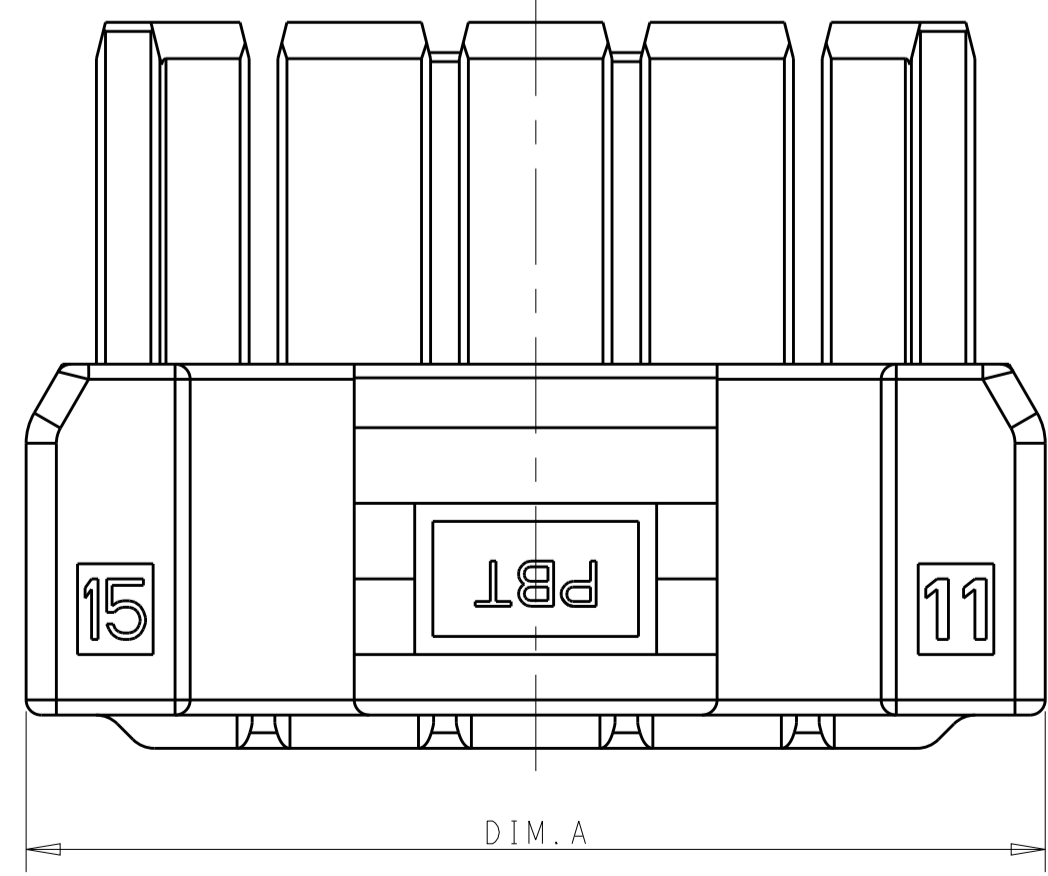
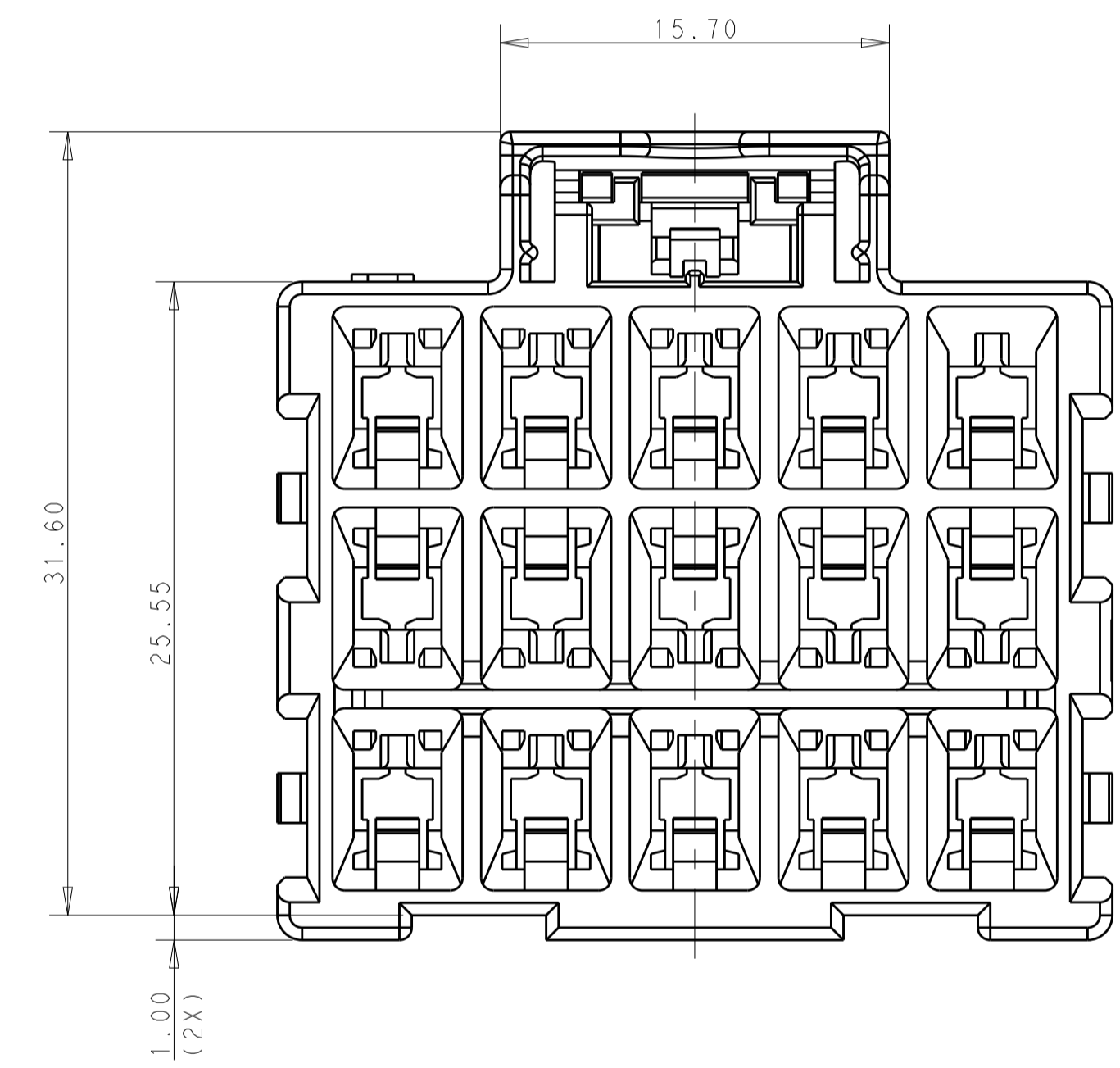
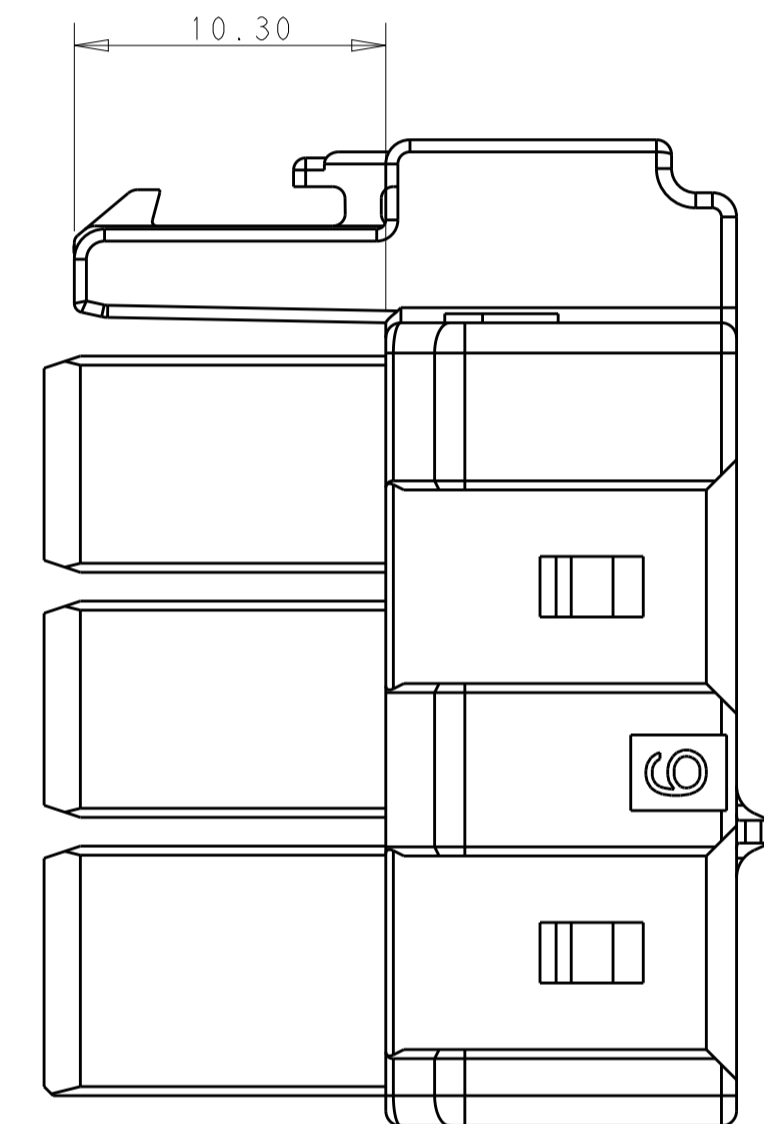
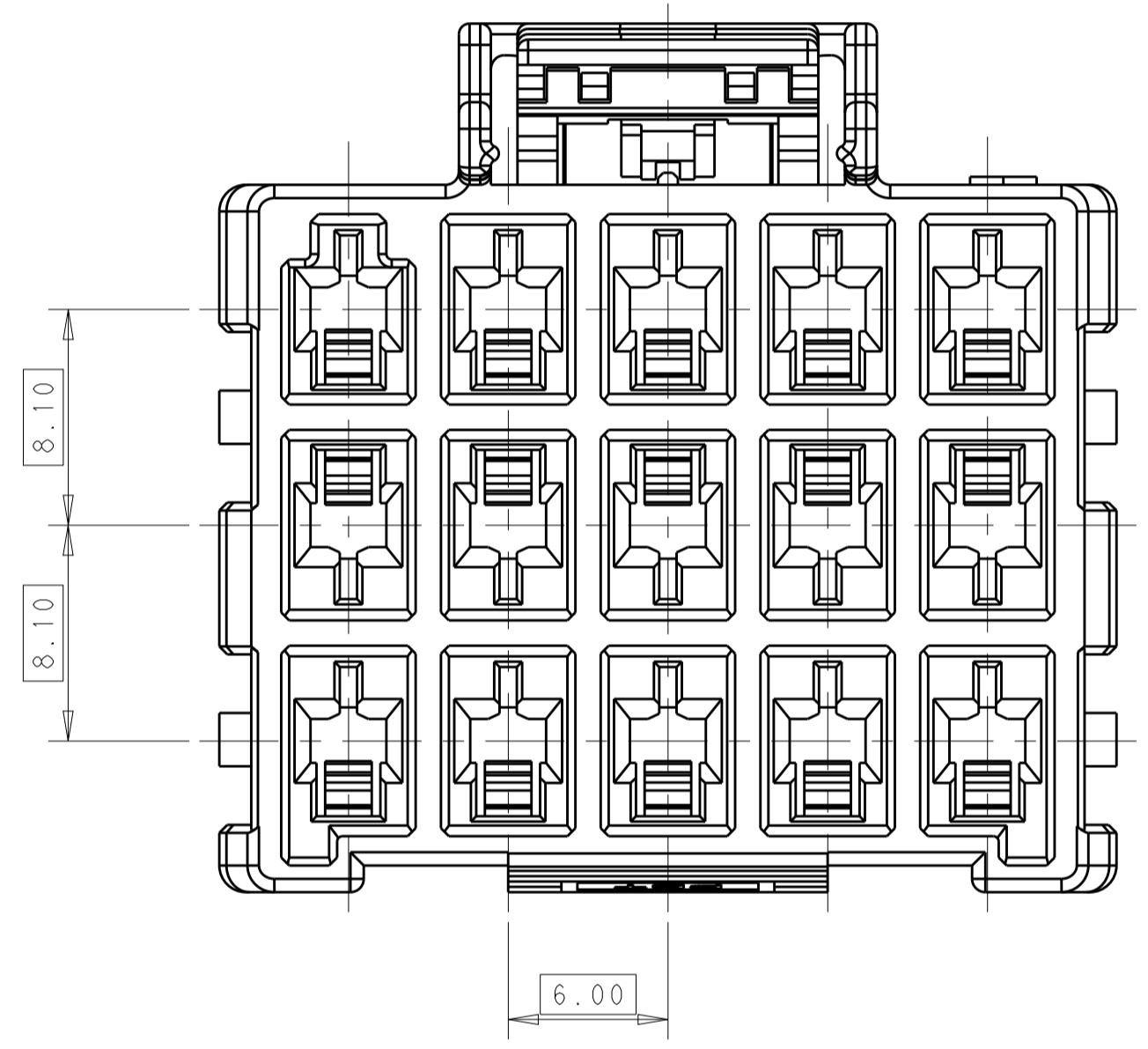

- NOTE
- MATERIAL:  
 LEVEL 1:PBT,STANDARD  
 KEY A:NATURAL; KEY B:PURPLE; KEY C:BLUE; KEY D:YELLOW  
 LEVEL 2:NYLON,HIGH TEMPERATURE 150°C  
 KEY A:LIGHT GREY; KEY B:LIGHT GREY; KEY C:LIGHT GREY; KEY D:LIGHT GREY
  - MATERIAL MARK:  
 LEVEL 1:PBT,LEVEL 2:HDT
  - APPLICABLE CONTACT P/N  
 REC CONTACT:1971237/1971779/81/83/85/87-\*
  - MATING CONN. P/N  
 CAP HSG:\*-1971874/5-  
 DOUBLE ROW LOCK PLATE:\*-1971778-\*;SINGLE ROW LOCK PLATE:\*-1971777-\*
  - PRODUCT SPEC: 108-106118
  - APPLICATION SPEC: 114-106118

1. This product has not completed validation testing.

|  |       |                            |  |
|--|-------|----------------------------|--|
| THIS DRAWING IS A CONTROLLED DOCUMENT. |       | DWN: TOMMY_WU 09JUL2012    | TE Connectivity                                  |
| DIMENSIONS: mm                         |       | CHK: HAPYE_WU 09JUL2012    |  |
| TOLERANCES UNLESS OTHERWISE SPECIFIED: |       | APVD: YIHONG_MAO 09JUL2012 | NAME: PLUG HOUSING, TRIPLE ROW POWER TRIPLE LOCK |
| 0 PLC                                  | ±     | PRODUCT SPEC               | SIZE: A1   |
| 1 PLC                                  | ±0.35 | 108-106118                 | CAGE CODE: C=1971876                             |
| 2 PLC                                  | ±0.25 | APPLICATION SPEC           | RESTRICTED TO: -                                 |
| 3 PLC                                  | ±     | 114-106118                 | SCALE: -   |
| 4 PLC                                  | ±     | WEIGHT: -                  | SHEET: 1 OF 2                                    |
| ANGLES                                 | ±     | Customer Drawing           | REV: A2  |

| LOC | DIST | REVISIONS     |      |     |      |
|-----|------|---------------|------|-----|------|
| P   | LTN  | DESCRIPTION   | DATE | OWN | APVD |
| -   | -    | -SEE SHEET 1- | -    | -   | -    |

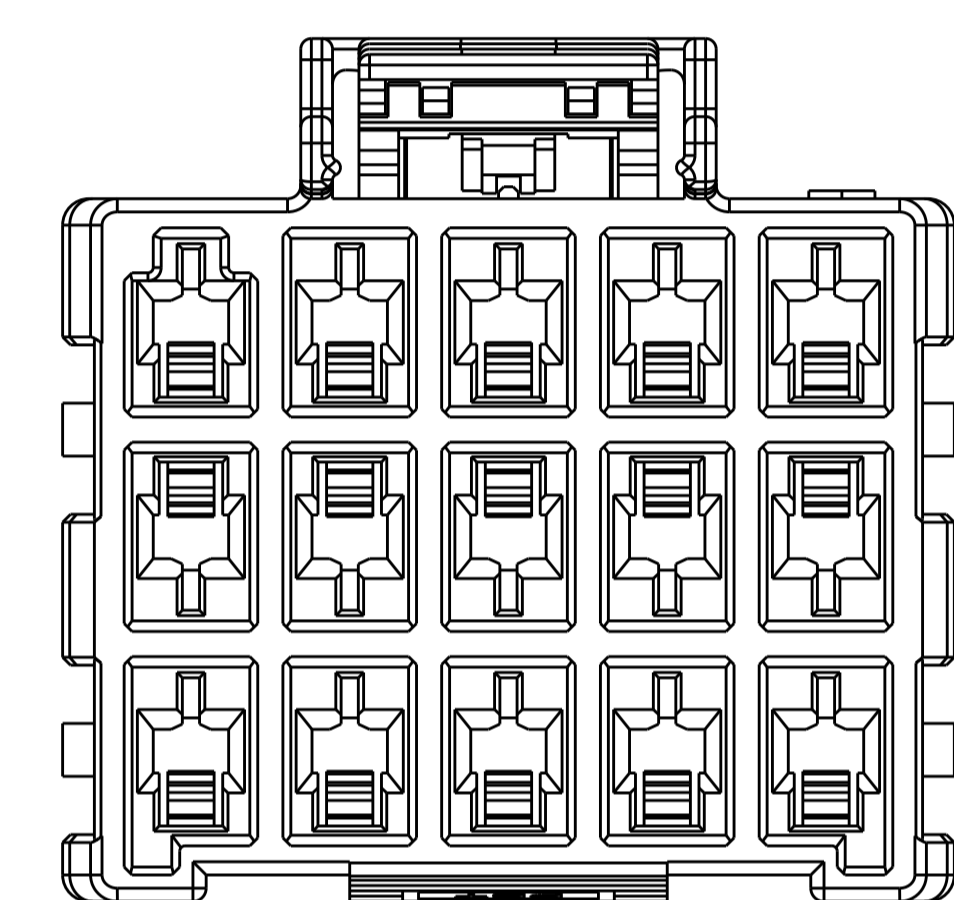
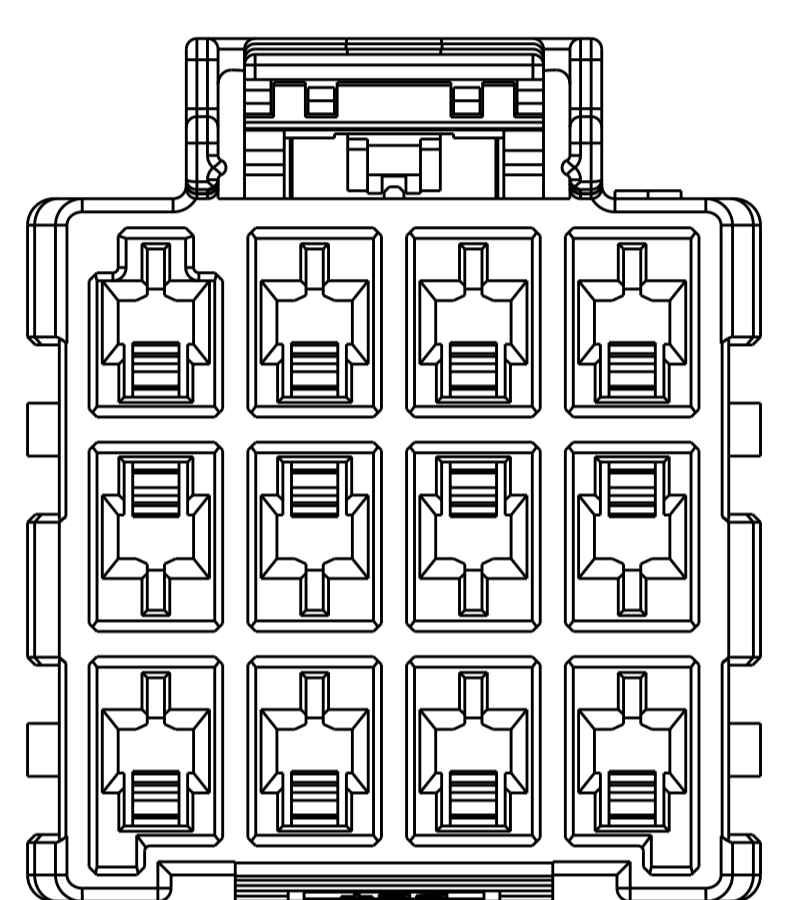
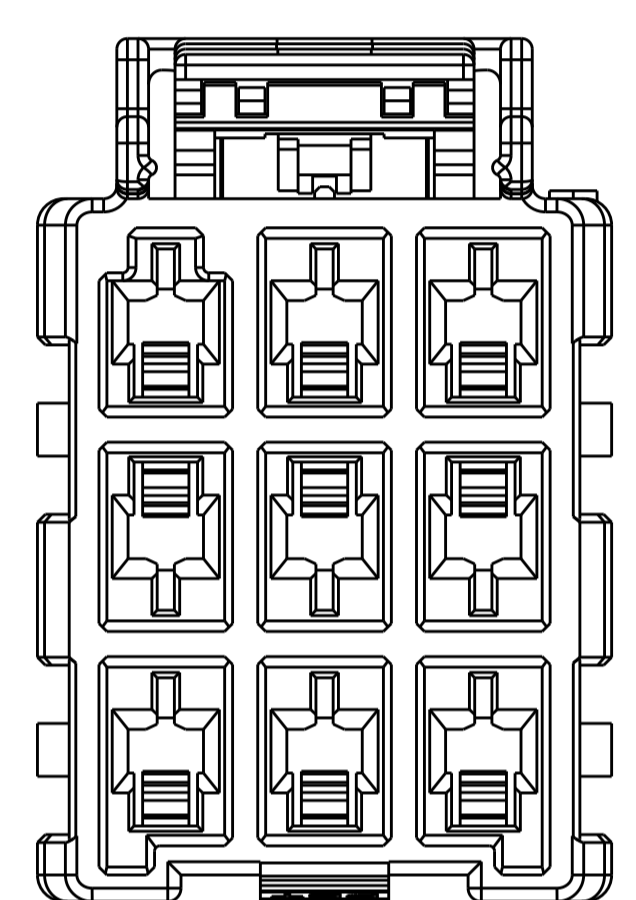
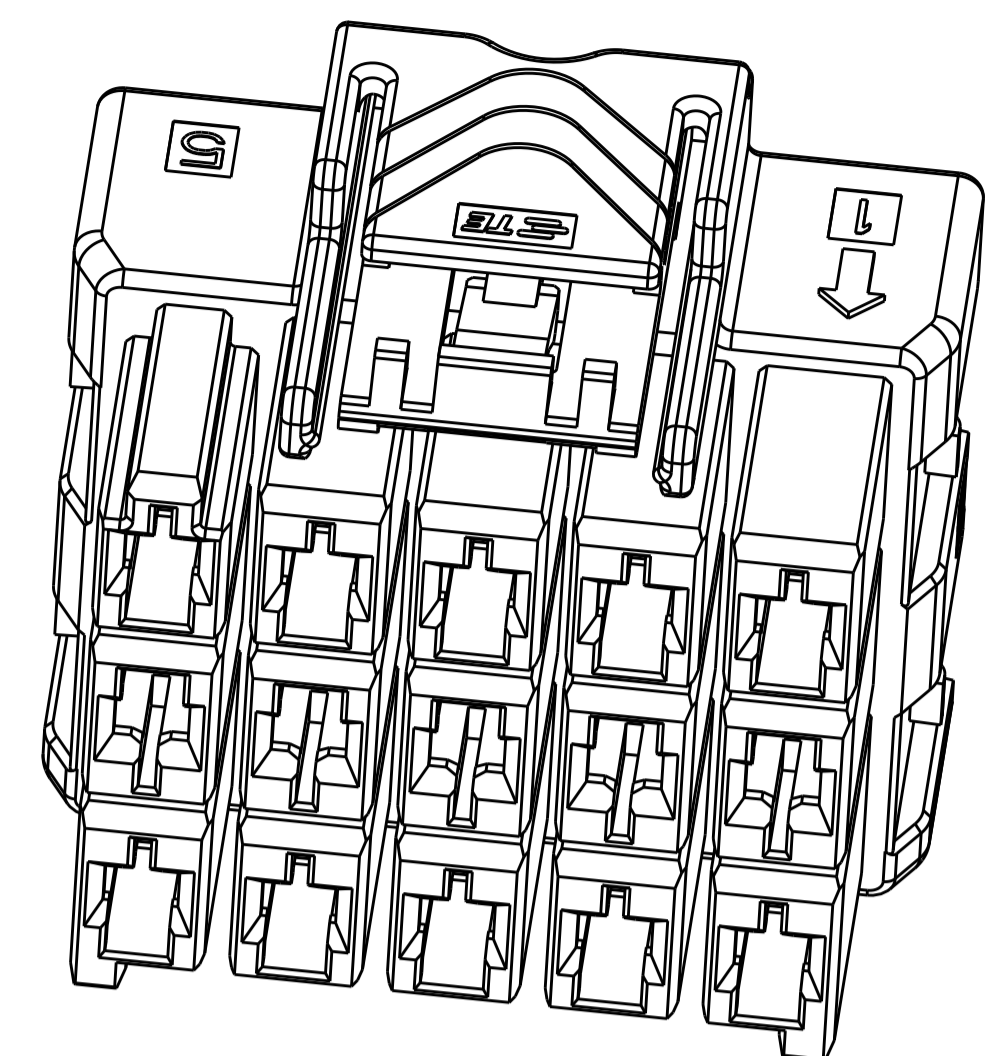
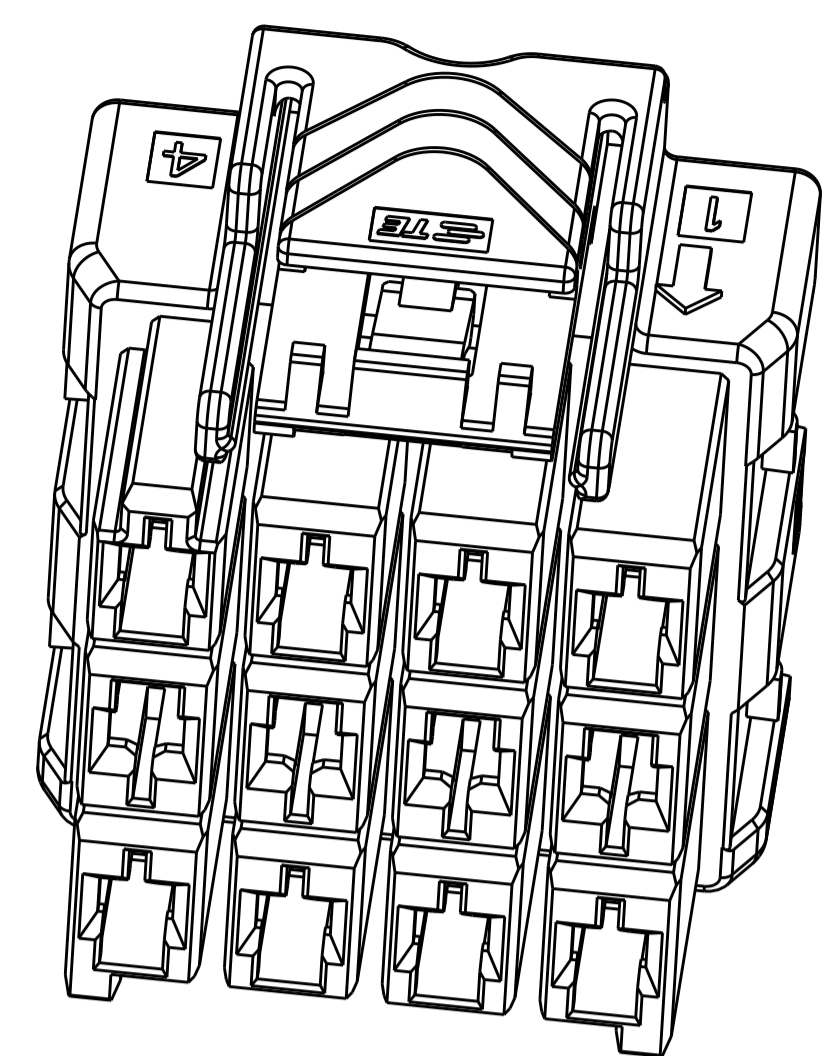
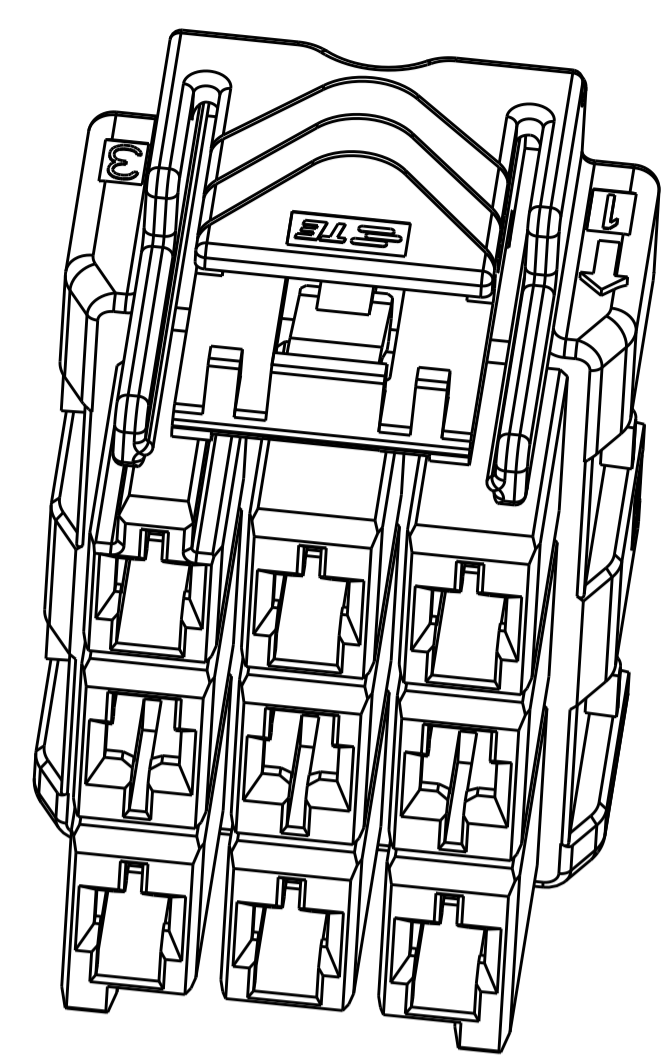

|      |          |       |             |
|------|----------|-------|-------------|
| 3*5  | LEVEL 1  | KEY A | 1-1971876-7 |
|      |          | KEY B | 2-1971876-7 |
|      |          | KEY C | 3-1971876-7 |
|      |          | KEY D | 4-1971876-7 |
| 3*5  | LEVEL 2  | KEY A | 5-1971876-7 |
|      |          | KEY B | 6-1971876-7 |
|      |          | KEY C | 7-1971876-7 |
|      |          | KEY D | 8-1971876-7 |
| 3*4  | LEVEL 1  | KEY A | 1-1971876-4 |
|      |          | KEY B | 2-1971876-4 |
|      |          | KEY C | 3-1971876-4 |
|      |          | KEY D | 4-1971876-4 |
| 3*4  | LEVEL 2  | KEY A | 5-1971876-4 |
|      |          | KEY B | 6-1971876-4 |
|      |          | KEY C | 7-1971876-4 |
|      |          | KEY D | 8-1971876-4 |
| 3*3  | LEVEL 1  | KEY A | 1-1971876-3 |
|      |          | KEY B | 2-1971876-3 |
|      |          | KEY C | 3-1971876-3 |
|      |          | KEY D | 4-1971876-3 |
| 3*3  | LEVEL 2  | KEY A | 5-1971876-3 |
|      |          | KEY B | 6-1971876-3 |
|      |          | KEY C | 7-1971876-3 |
|      |          | KEY D | 8-1971876-3 |
| POS. | MATERIAL | KEY   | P/N         |

3\*3 POSITIONS

3\*4 POSITIONS

3\*5 POSITIONS

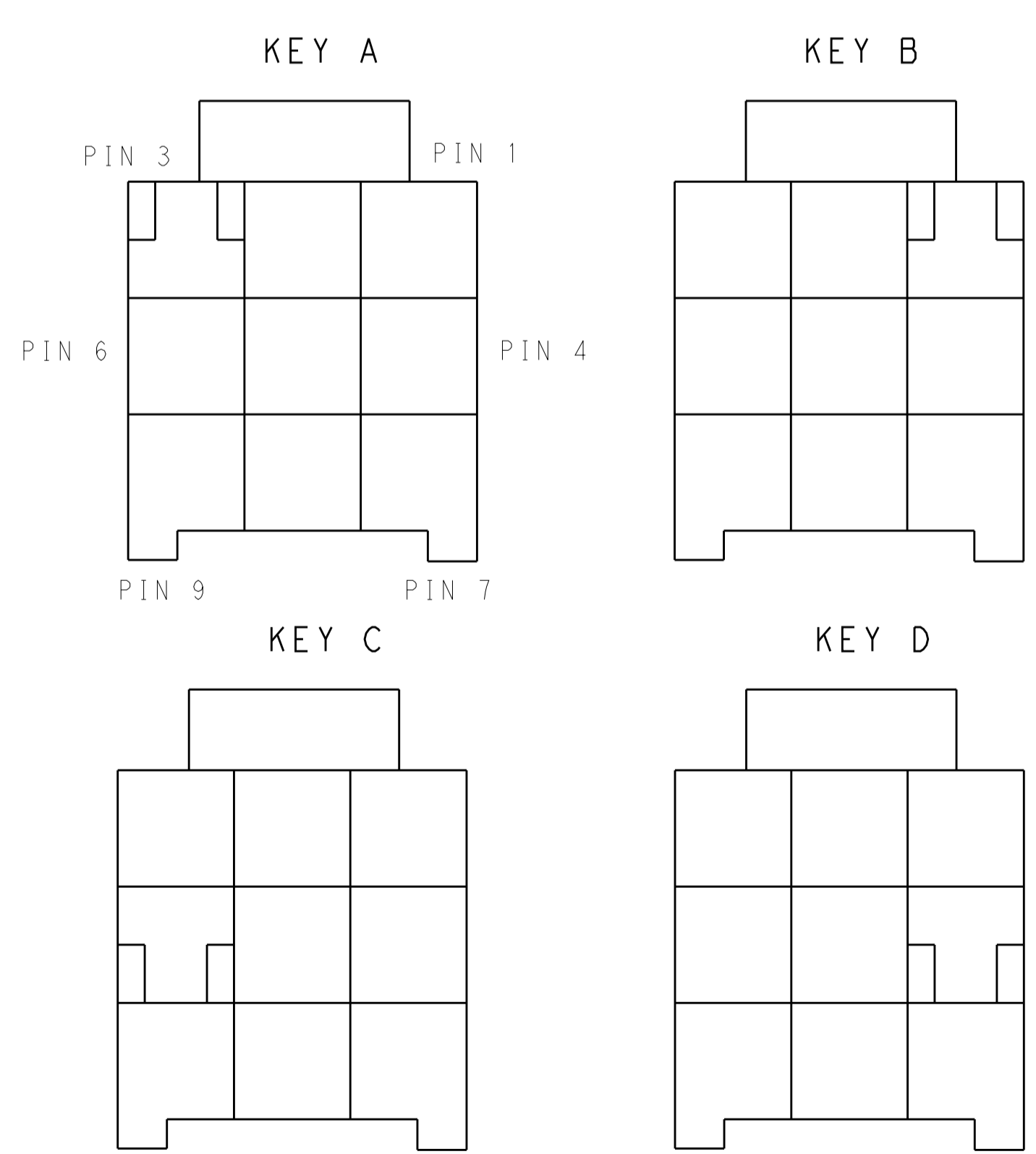

KEYING FOR 3\*3 POS.

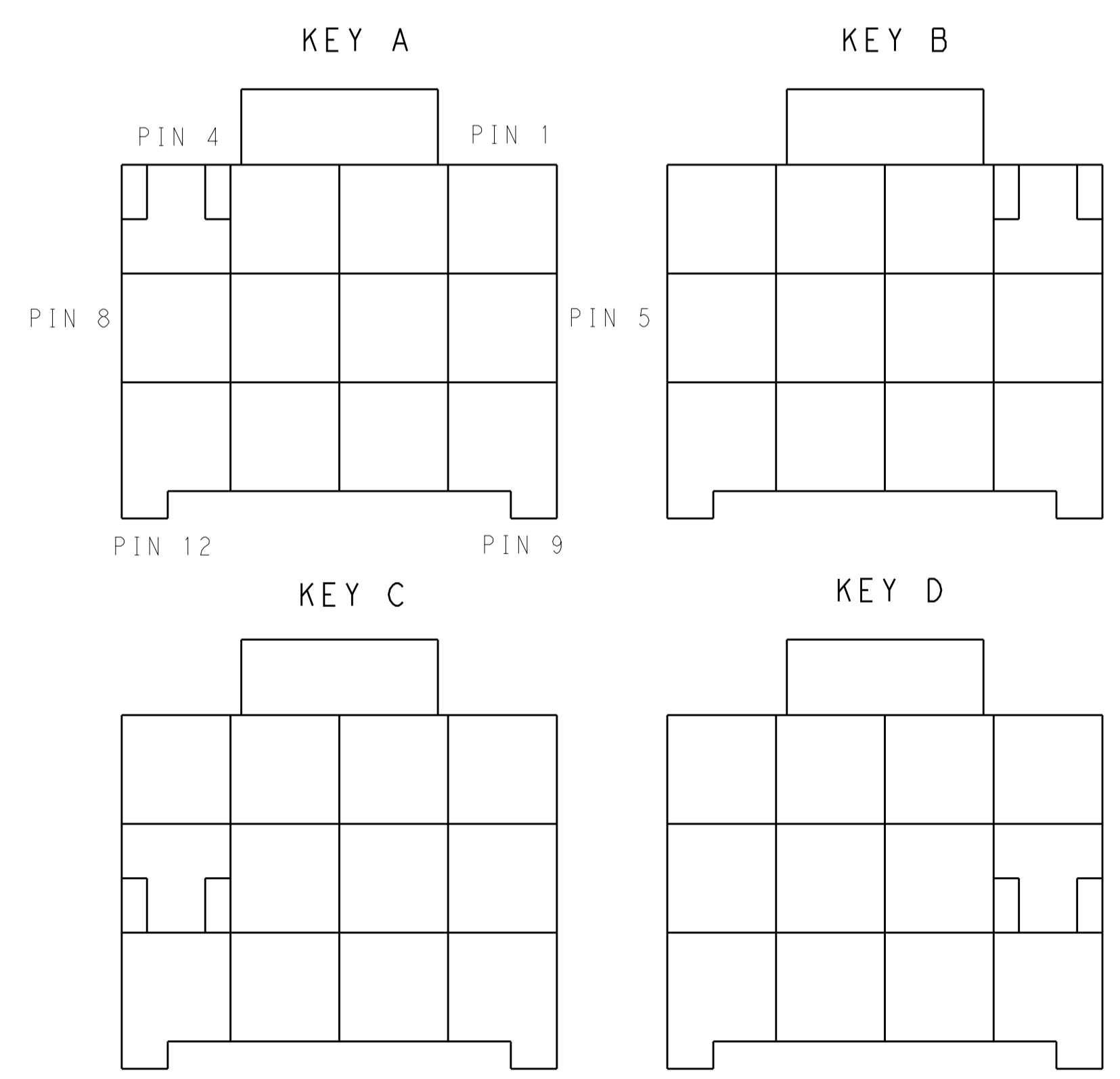

KEYING FOR 3\*4 POS.

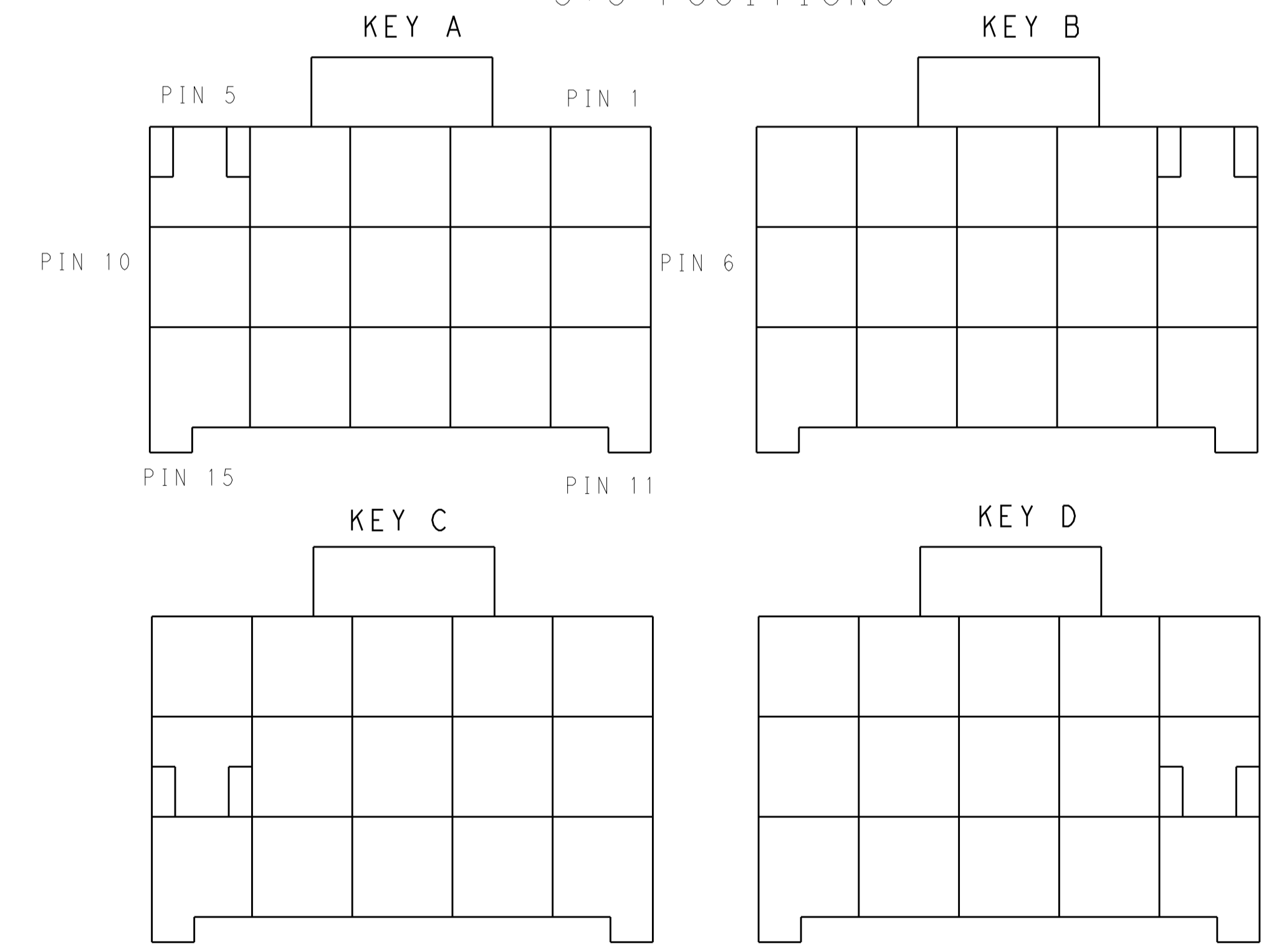

KEYING FOR 3\*5 POS.

|   |  |   |   |
|---|--|---|---|
| THIS DRAWING IS A CONTROLLED DOCUMENT.                                  |  | OWN: TOMMY_WU 09JUL2012   | TE Connectivity<br>PLUG HOUSING, TRIPLE ROW<br>POWER TRIPLE LOCK                |
| DIMENSIONS: mm  |  | CHK: HAPYE_WU 09JUL2012   |   |
| TOLERANCES UNLESS OTHERWISE SPECIFIED:                                  |  | APVD: YIHONG_MAO 09JUL2012  |   |
| 0 PLC ±<br>1 PLC ±0.35<br>2 PLC ±0.25<br>3 PLC ±<br>4 PLC ±<br>ANGLES ± |  | PRODUCT SPEC: 108-106118<br>APPLICATION SPEC: 114-106118<br>WEIGHT: -<br>Customer Drawing |   |
| MATERIAL: -   |  | FINISH: -   | SIZE: A1<br>CAGE CODE: 00779<br>DRAWING NO: 1971876<br>SHEET: 2 OF 2<br>REV: A2 |