

LOC		DIST		REVISIONS			
P	LTN	DESCRIPTION	DATE	DWN	APVD		
A		RELEASED DRAWING	04FEB2013	T.W	YH.M		
A2		ECR-13-005295	26MAR2013	T.W	YH.M		

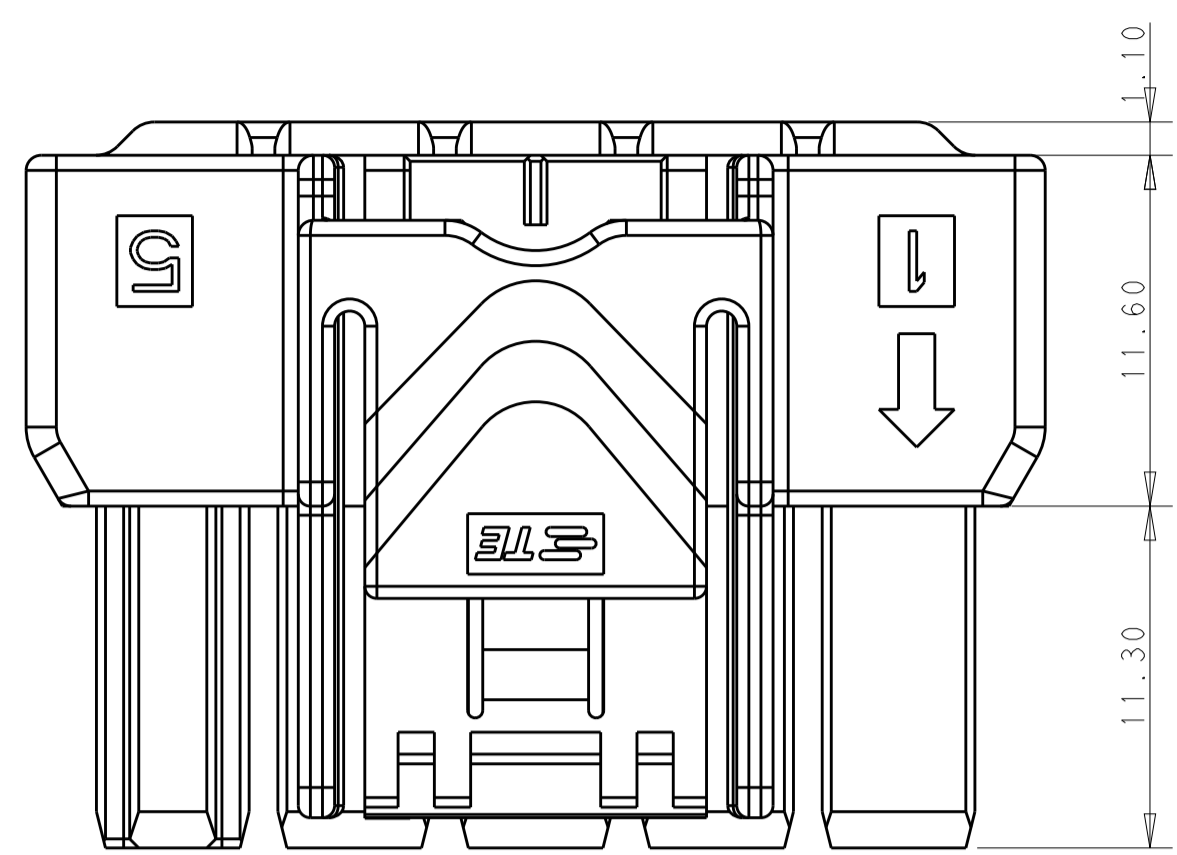

POS.	DIM. A
3*5	33.70
3*4	27.70
3*3	21.70

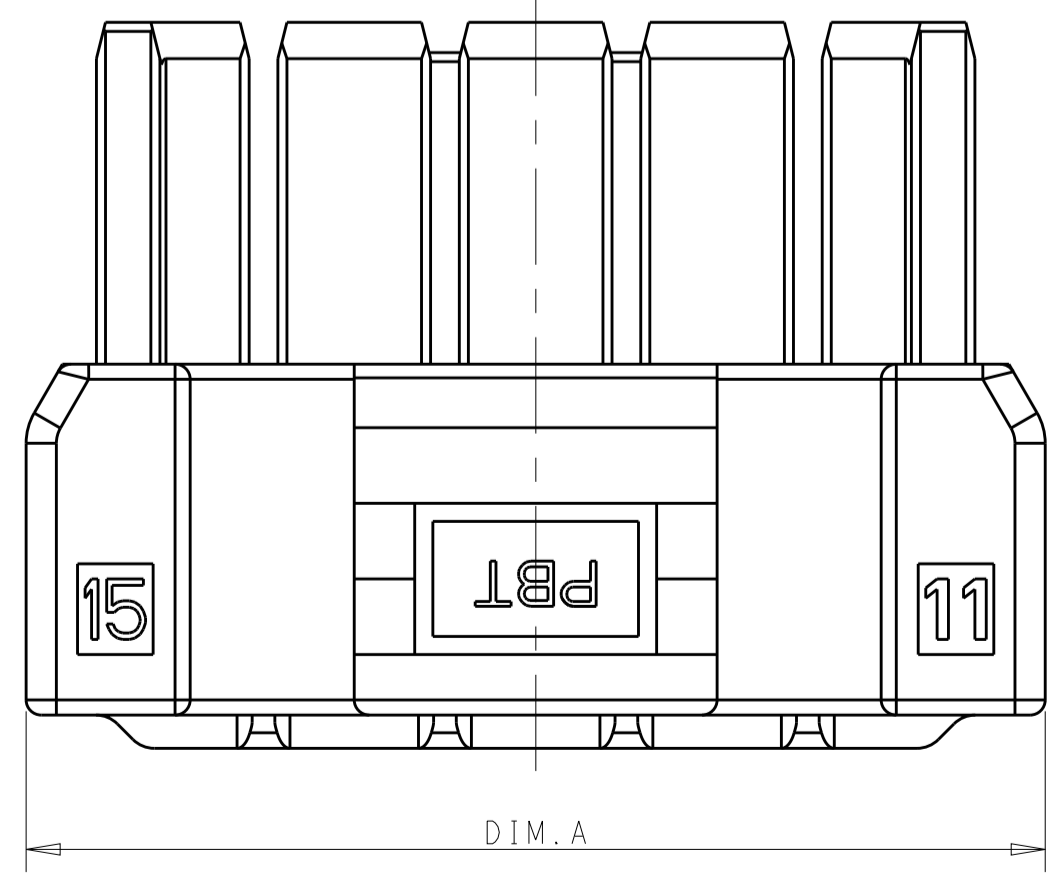
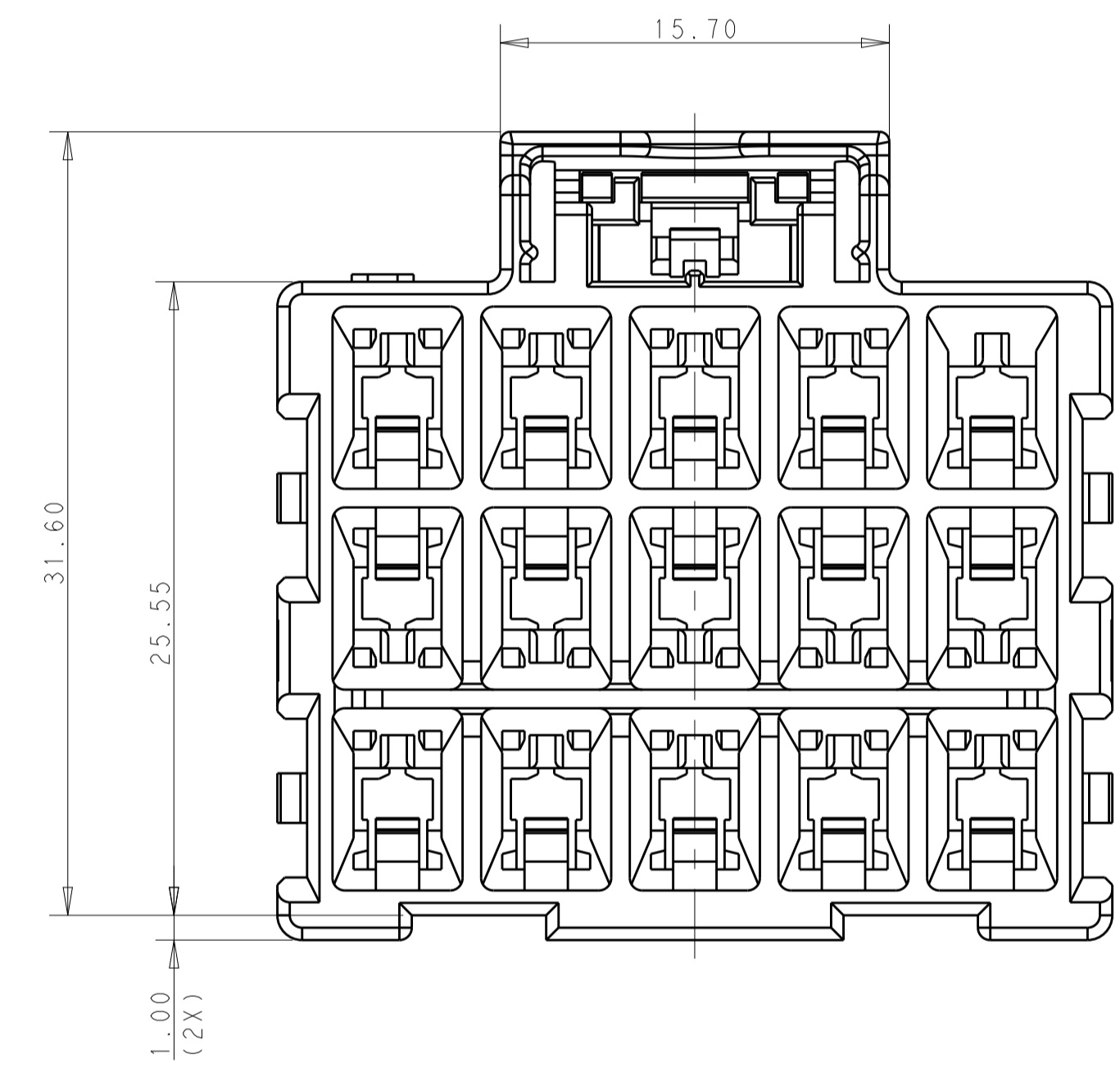
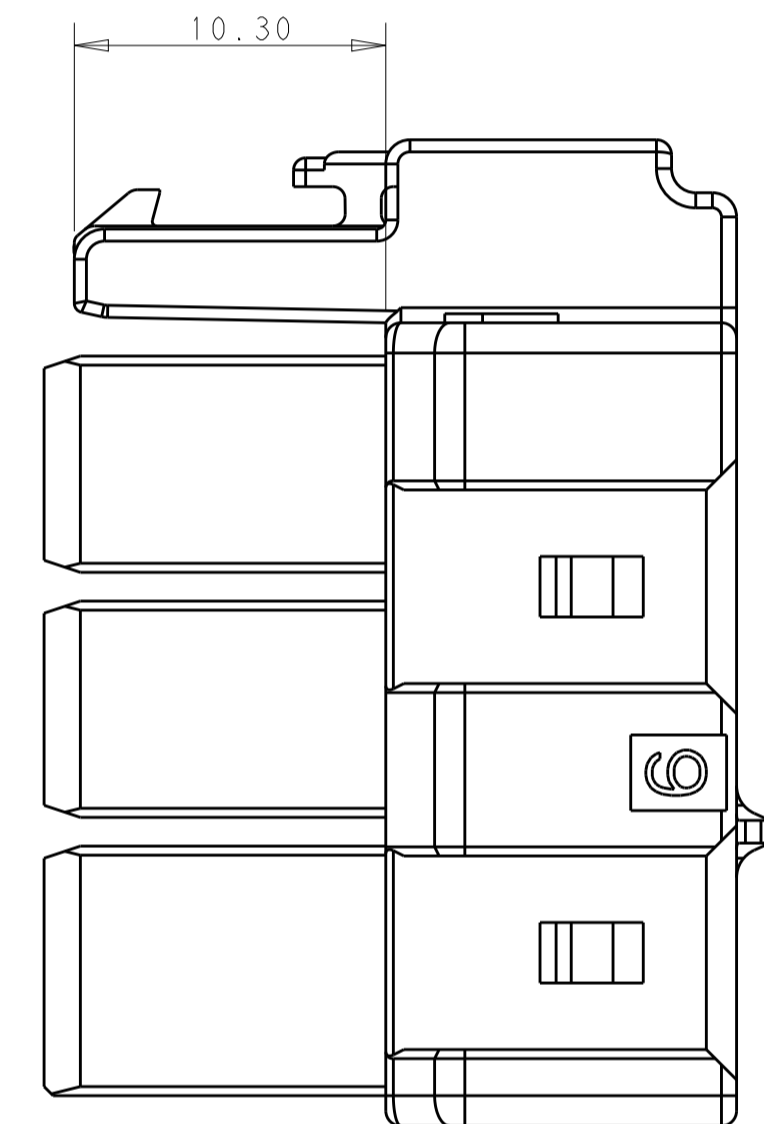
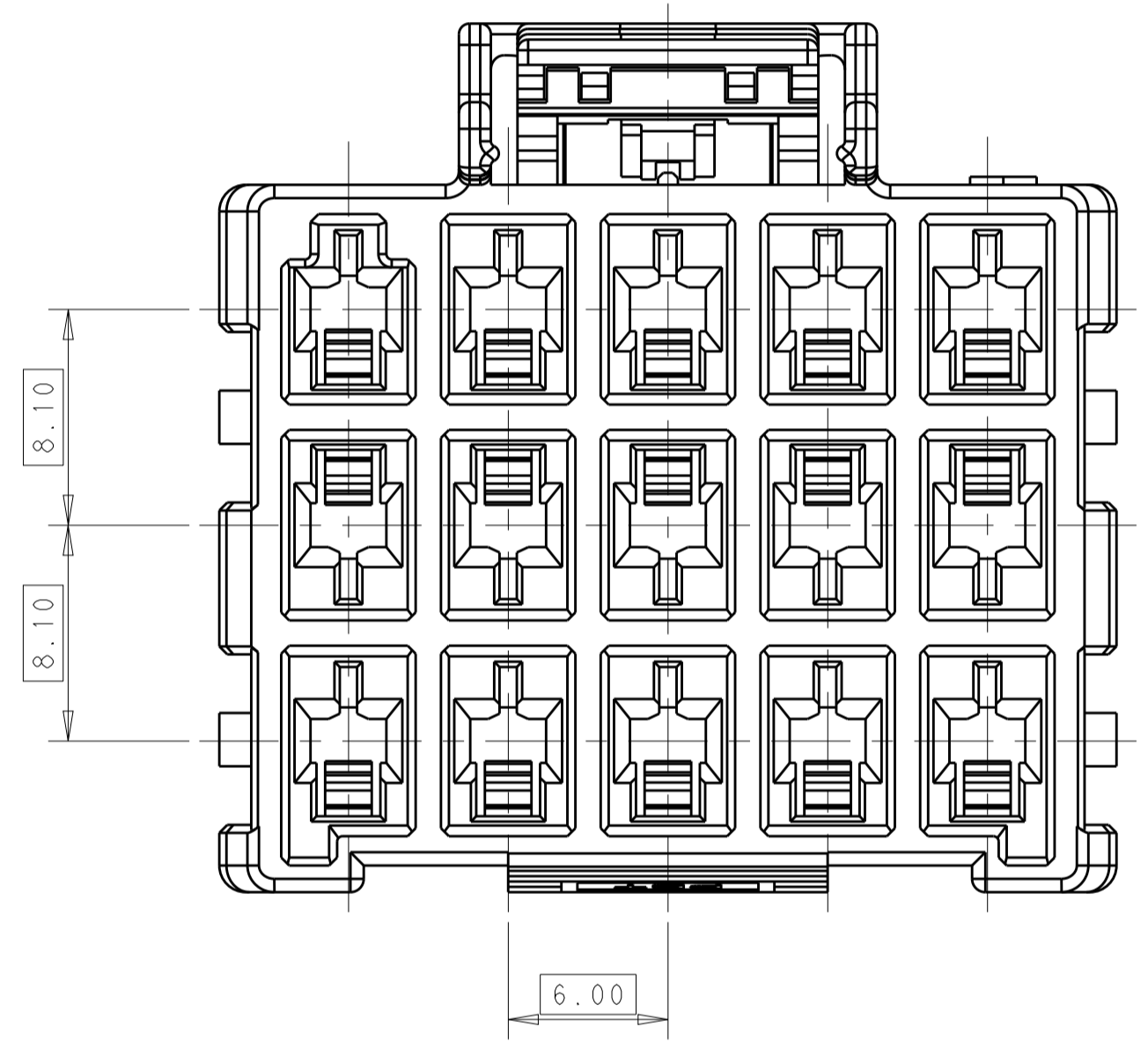

- NOTE
- MATERIAL:
 LEVEL 1:PBT,STANDARD
 KEY A:NATURAL; KEY B:PURPLE; KEY C:BLUE; KEY D:YELLOW
 LEVEL 2:NYLON,HIGH TEMPERATURE 150°C
 KEY A:LIGHT GREY; KEY B:LIGHT GREY; KEY C:LIGHT GREY; KEY D:LIGHT GREY
 - MATERIAL MARK:
 LEVEL 1:PBT,LEVEL 2:HDT
 - APPLICABLE CONTACT P/N
 REC CONTACT:1971237/1971779/81/83/85/87-*
 - MATING CONN. P/N
 CAP HSG:*-1971874/5-
 DOUBLE ROW LOCK PLATE:*-1971778-*;SINGLE ROW LOCK PLATE:*-1971777-*
 - PRODUCT SPEC: 108-106118
 - APPLICATION SPEC: 114-106118

1. This product has not completed validation testing.

THIS DRAWING IS A CONTROLLED DOCUMENT.		DWN: TOMMY_WU 09JUL2012	TE Connectivity NAME: PLUG HOUSING, TRIPLE ROW POWER TRIPLE LOCK
DIMENSIONS:		CHK: HAPYE_WU 09JUL2012	
mm		APVD: YIHONG_MAO 09JUL2012	
0 PLC ± 1 PLC ±0.35 2 PLC ±0.25 3 PLC ± 4 PLC ± ANGLES ±		PRODUCT SPEC: 108-106118 APPLICATION SPEC: 114-106118	
MATERIAL:	FINISH:	WEIGHT:	SIZE: A1 CAGE CODE: 100779 DRAWING NO: C=1971876 RESTRICTED TO: - SCALE: - SHEET 1 OF 2 REV: A2

LOC		DIST		REVISIONS			
P	LTN	DATE	OWN	APVD	DESCRIPTION		
-	-	-	-	-	-SEE SHEET 1-		

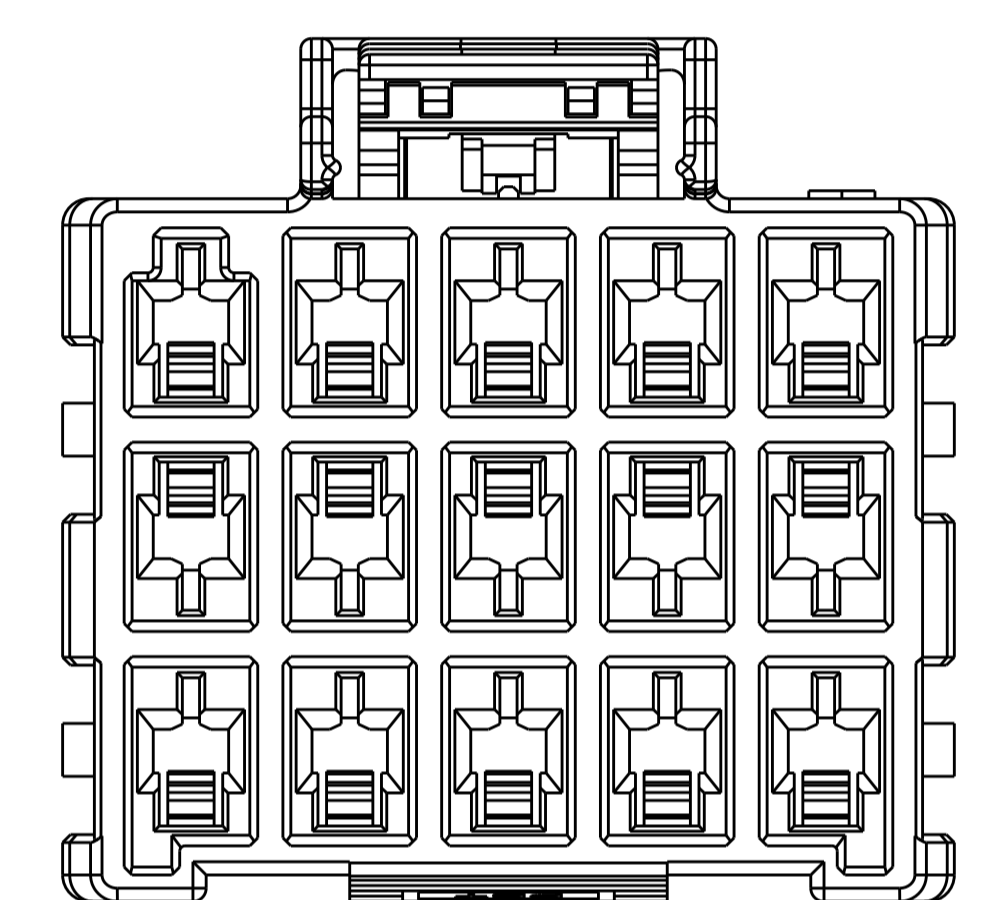
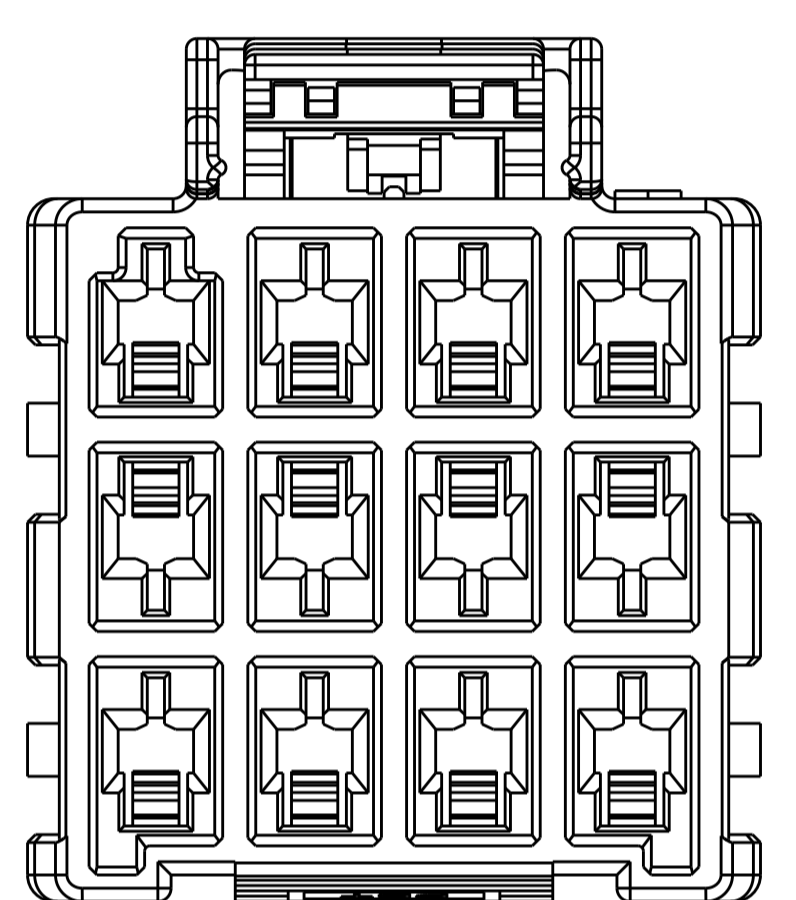
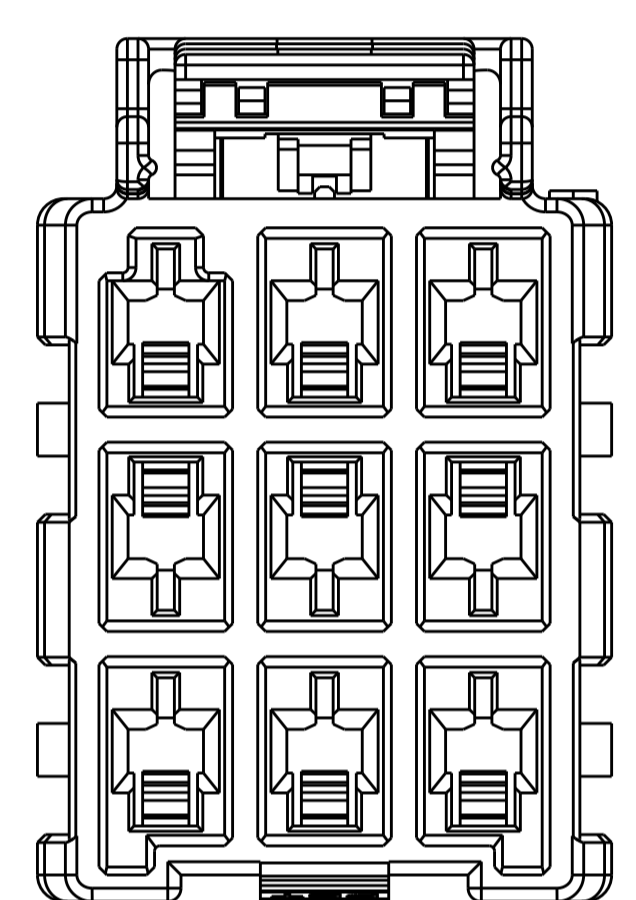
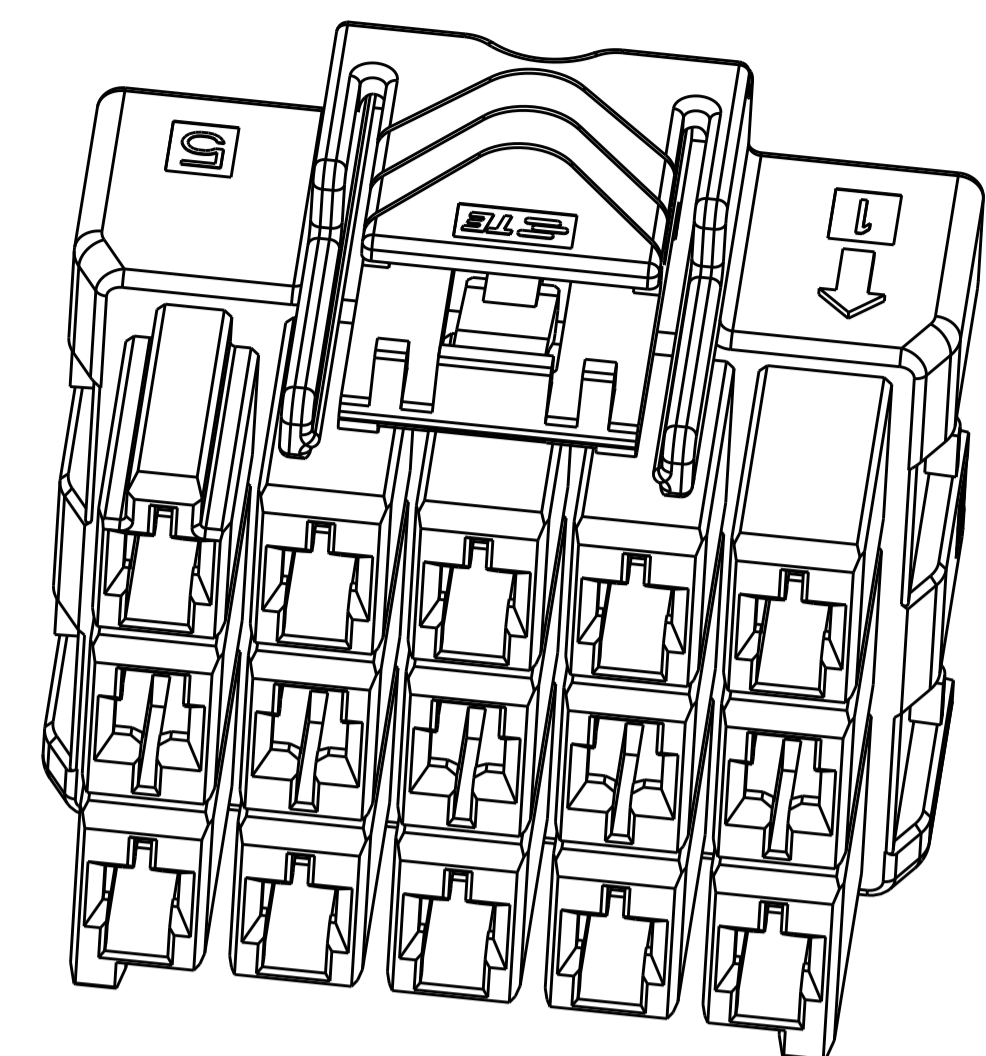
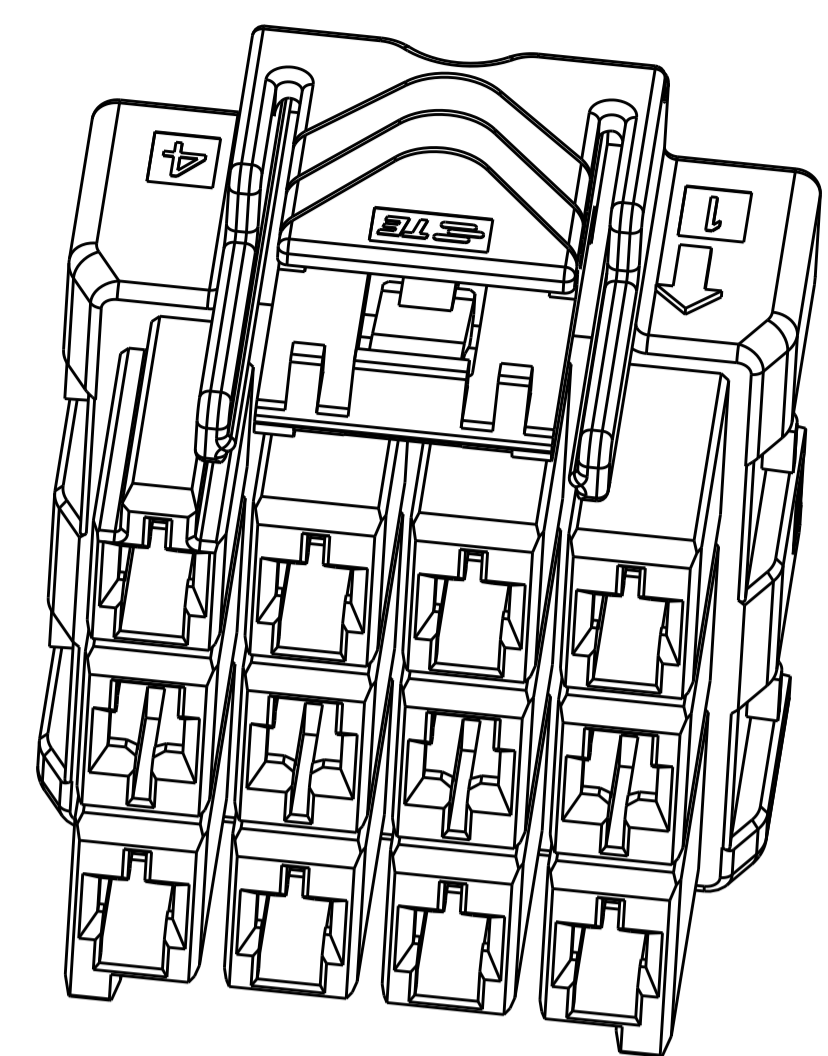
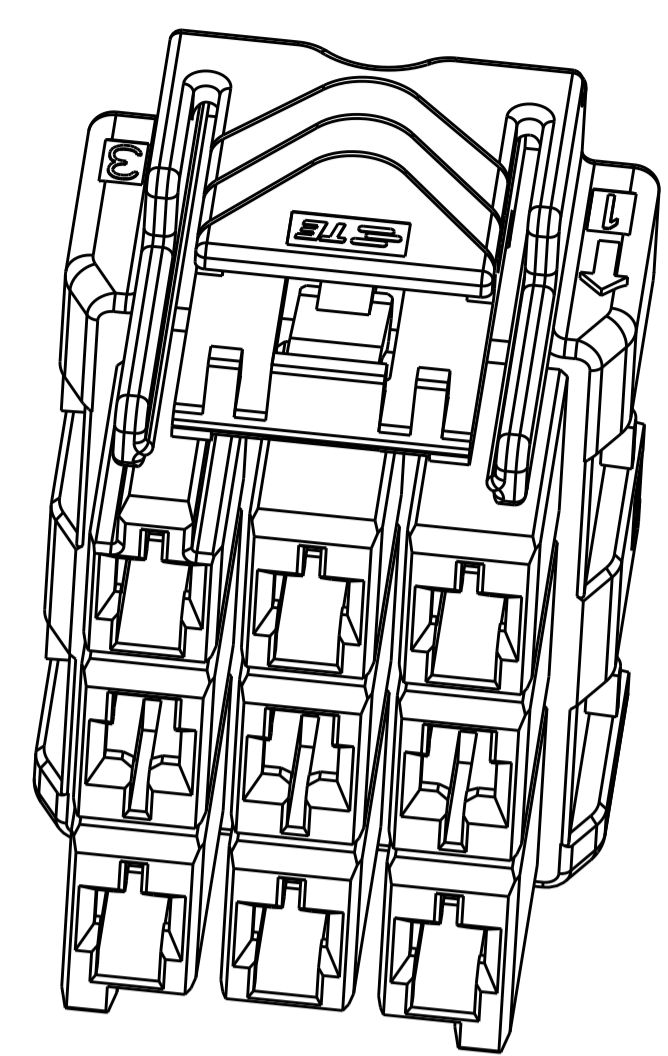

POS.	MATERIAL	KEY	P/N
3*5	LEVEL 1	KEY A	1-1971876-7
		KEY B	2-1971876-7
		KEY C	3-1971876-7
		KEY D	4-1971876-7
3*5	LEVEL 2	KEY A	5-1971876-7
		KEY B	6-1971876-7
		KEY C	7-1971876-7
		KEY D	8-1971876-7
3*4	LEVEL 1	KEY A	1-1971876-4
		KEY B	2-1971876-4
		KEY C	3-1971876-4
		KEY D	4-1971876-4
3*4	LEVEL 2	KEY A	5-1971876-4
		KEY B	6-1971876-4
		KEY C	7-1971876-4
		KEY D	8-1971876-4
3*3	LEVEL 1	KEY A	1-1971876-3
		KEY B	2-1971876-3
		KEY C	3-1971876-3
		KEY D	4-1971876-3
3*3	LEVEL 2	KEY A	5-1971876-3
		KEY B	6-1971876-3
		KEY C	7-1971876-3
		KEY D	8-1971876-3

3*3 POSITIONS

3*4 POSITIONS

3*5 POSITIONS

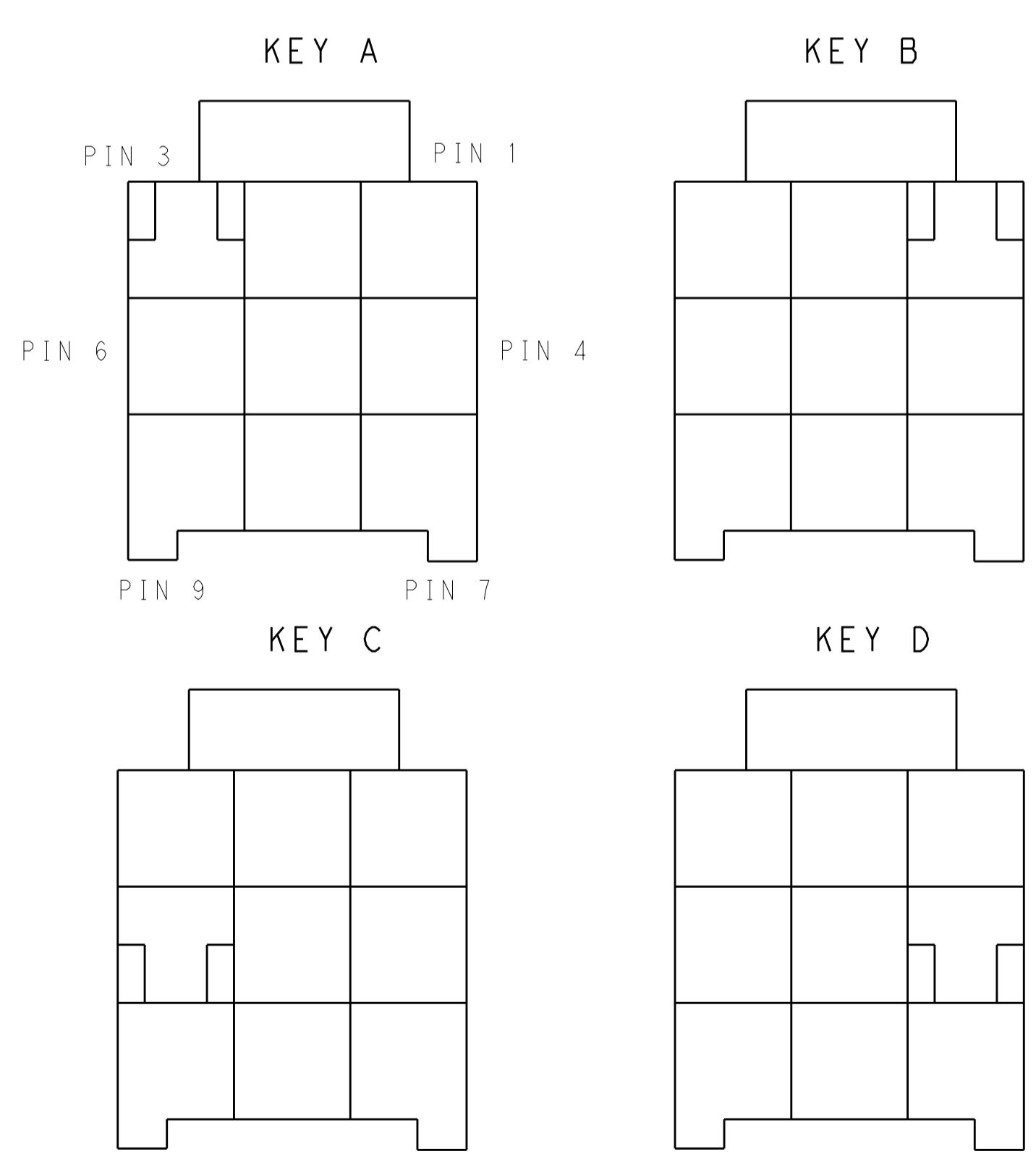

KEYING FOR 3*3 POS.

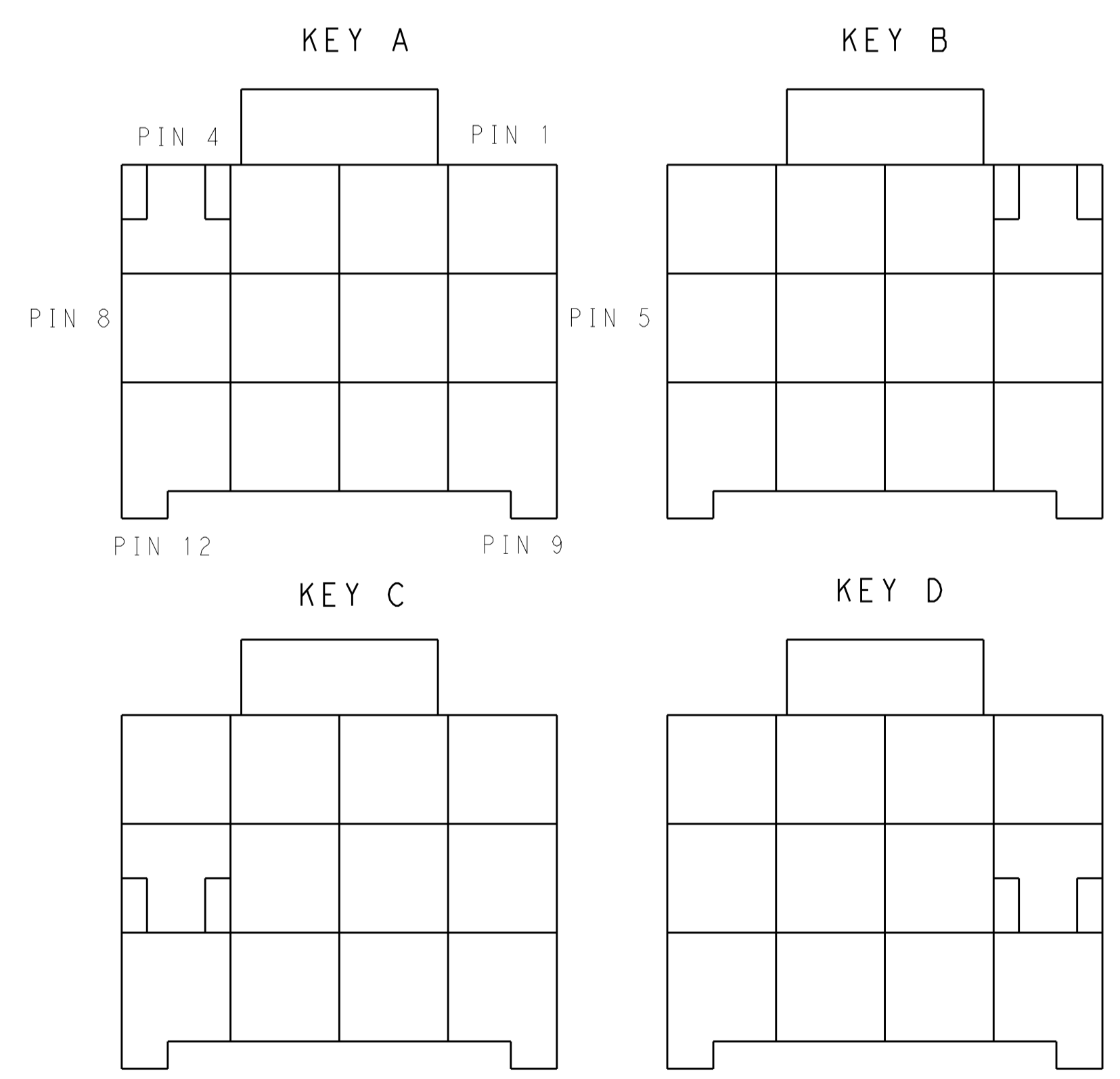

KEYING FOR 3*4 POS.

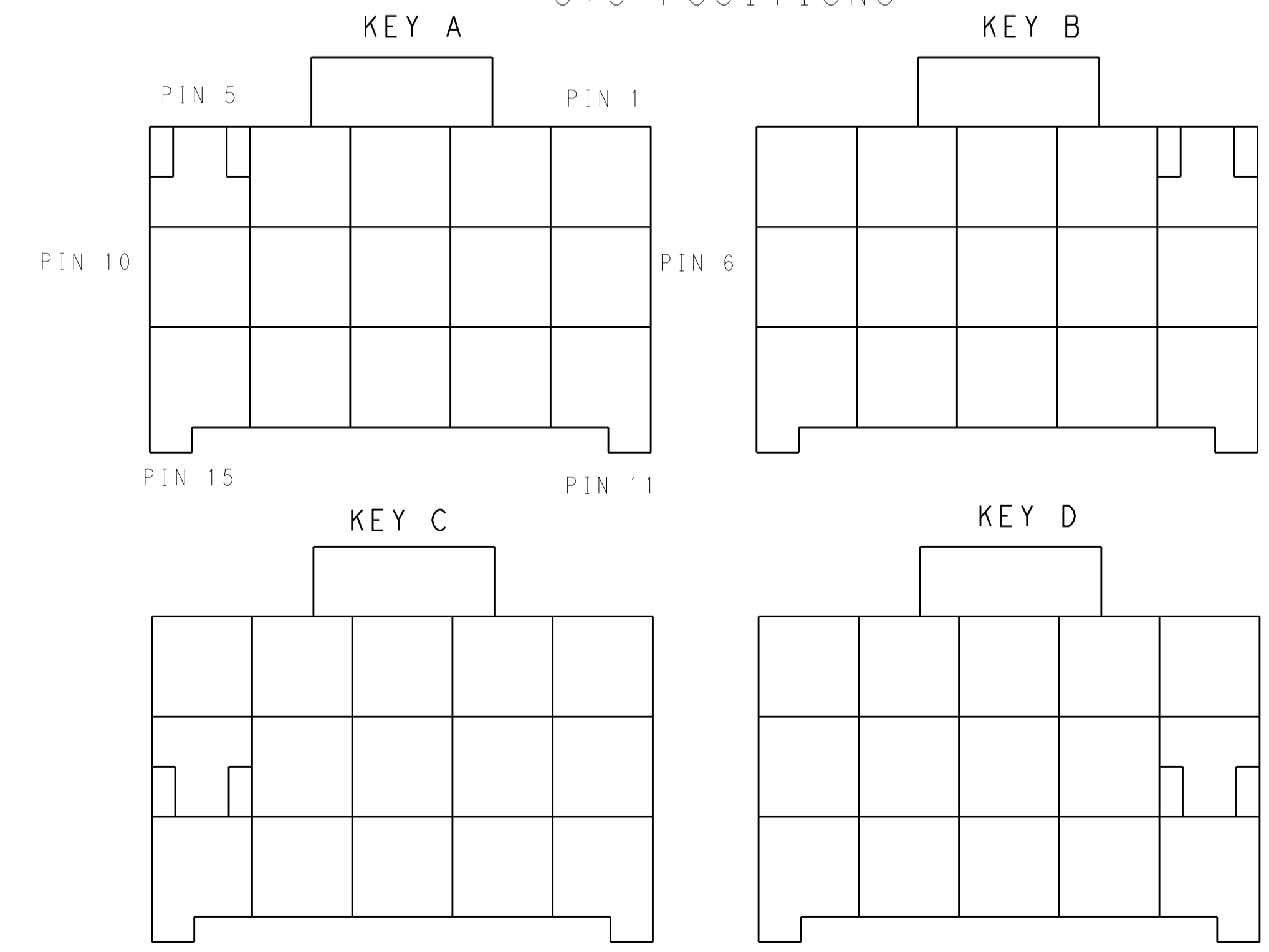

KEYING FOR 3*5 POS.

THIS DRAWING IS A CONTROLLED DOCUMENT.		OWN: TOMMY_WU 09JUL2012	TE Connectivity PLUG HOUSING, TRIPLE ROW POWER TRIPLE LOCK
DIMENSIONS: mm		CHK: HAPYE_WU 09JUL2012	
TOLERANCES UNLESS OTHERWISE SPECIFIED:		APVD: YIHONG_MAO 09JUL2012	
0 PLC ± 1 PLC ±0.35 2 PLC ±0.25 3 PLC ± 4 PLC ± ANGLES ±		PRODUCT SPEC: 108-106118 APPLICATION SPEC: 114-106118 WEIGHT: - Customer Drawing	
MATERIAL: -		FINISH: -	SIZE: A1 CAGE CODE: 00779 DRAWING NO: 1971876 SHEET 2 OF 2 REV A2