

### Metallized Polypropylene Film Capacitor

Type: **ECWH(C)**

Designed for high frequency and pulse applications.

#### ■ Features

- Excellent electrical characteristics
- Low loss
- Flame-retardant epoxy resin coating
- RoHS directive compliant

#### ■ Recommended Applications

- General resonance circuit (630 VDC)
- Resonance circuits for microwave oven and IH cooker (630 VDC)
- Resonance circuits for microwave oven (630 VDC, 1250 VDC)
- General high voltage circuit (3000 VDC)



#### ■ Explanation of Part Numbers (630 VDC)

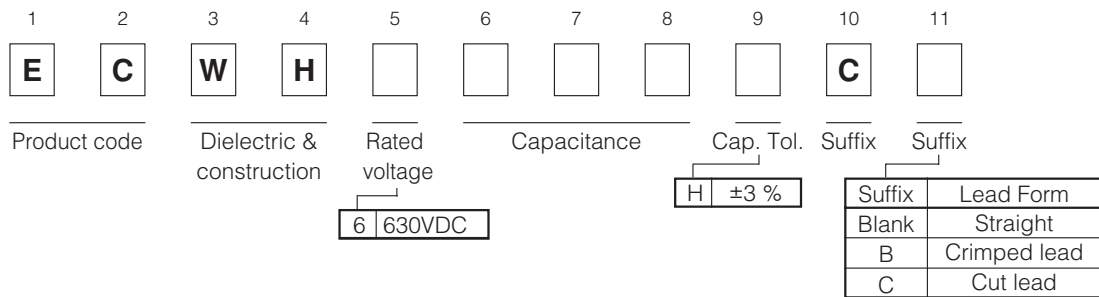

#### ■ Explanation of Part Number for Odd Size Taping (630 VDC)

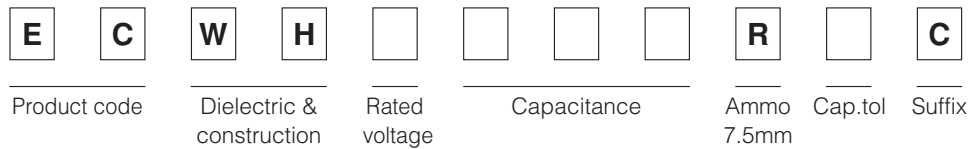

#### ■ Explanation of Part Numbers (1250 VDC)

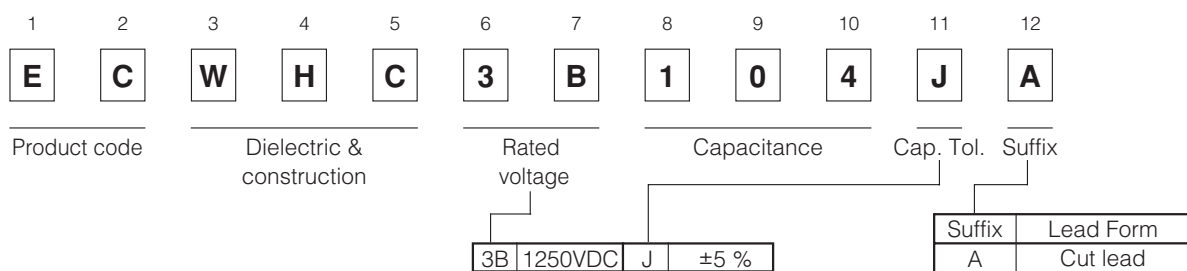

#### ■ Explanation of Part Numbers (3000 VDC)

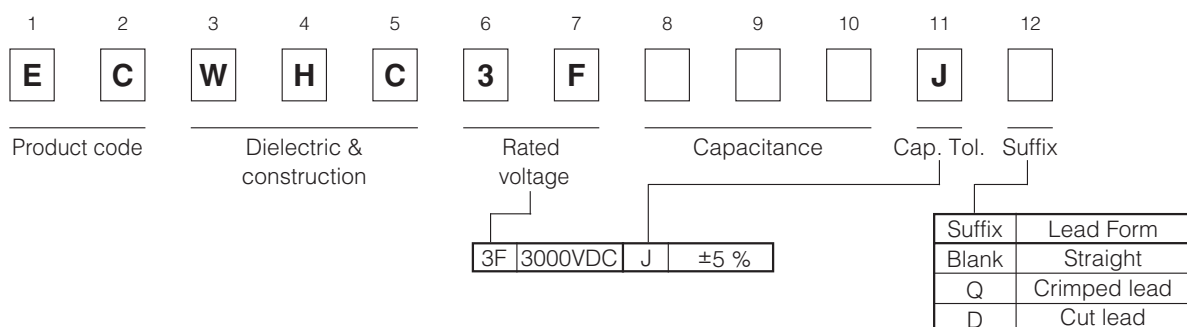

Design, Specifications are subject to change without notice. Ask factory for technical specifications before purchase and/or use. Whenever a doubt about safety arises from this product, please inform us immediately for technical consultation without fail.

## Specifications

|  |  |   |
|--|--|---|
| Category temp. range<br>(Including temperature-rise on unit surface) | 630 VDC  | -40 °C to 105 °C : General resonance circuit                                |
|  | 1250 VDC   | -40 °C to 85 °C : When using compulsive air cooling for a resonance circuit |
|  | 3000 VDC   | -40 °C to 85 °C : General high voltage circuit                              |
| Rated voltage  | 630 VDC, 1250 VDC, 3000 VDC                        |   |
| Capacitance range  | 630 VDC  | 0.18 μF to 0.33 μF  |
|  | 1250 VDC   | 0.10 μF   |
|  | 3000 VDC   | 0.0024 μF to 0.01 μF  |
| Capacitance tolerance  | 630 VDC  | ±3 % (H)  |
|  | 1250 VDC   | ±5 % (J)  |
|  | 3000 VDC   | ±5 % (J)  |
| Dissipation factor (tan δ)   | 630 VDC  | tan δ ≤ 0.05 % (20 °C, 1 kHz), tan δ ≤ 0.1 % (20 °C, 10 kHz)                |
|  | 1250 VDC   |   |
|  | 3000 VDC   | tan δ ≤ 0.1 % (20 °C, 1 kHz), tan δ ≤ 0.1 % (20 °C, 10 kHz)                 |
| Withstand voltage  | Between terminals : Rated volt. (VDC) × 150 % 60 s |   |
| Insulation resistance (IR)   | 630 VDC  | IR ≥ 9000 MΩ (20 °C, 500 VDC, 60 s)   |
|  | 1250 VDC   |   |
|  | 3000 VDC   | IR ≥ 50000 MΩ (20 °C, 500 VDC, 60 s)  |

\* In case of applying voltage in alternating current (50 Hz or 60 Hz sine wave) to a capacitor with DC rated voltage, please refer to the page of "Permissible voltage (R.M.S) in alternating current corresponding to DC rated voltage".

## Dimensions in mm (not to scale)

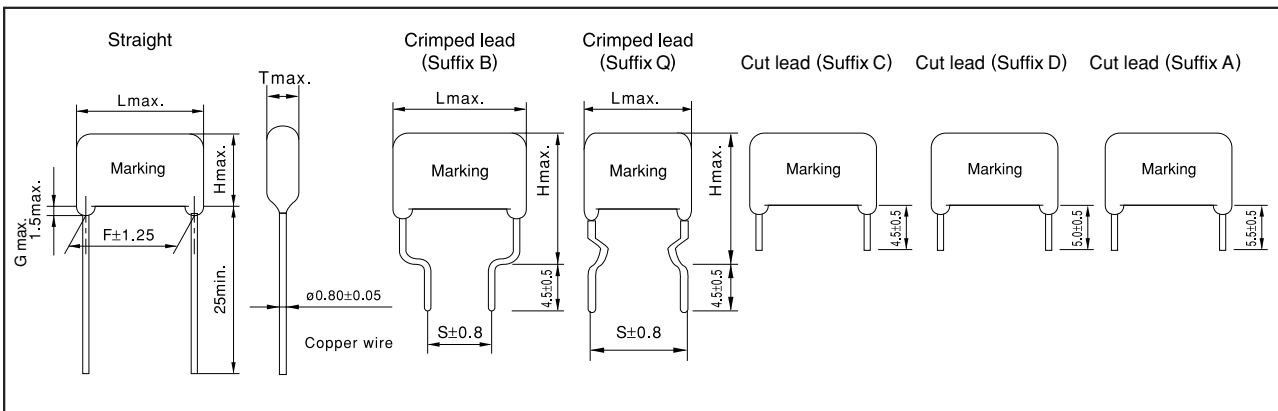

## Packaging Specifications for Bulk Package

Packing quantity : 100 pcs./bag

## Taping Specifications for Automatic Insertion

### Taping style

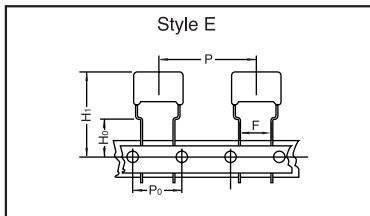

\*Refer to the page of taping specifications.

## Packaging Specifications

| Type    | Rated volt. | Cap. range (μF) | Taping style |    |   |   |   |   | Packing |
|---------|-------------|-----------------|--------------|----|---|---|---|---|---------|
|         |             |                 | AD           | AS | B | C | D | E |         |
| ECWH(C) | 630 VDC     | 0.18 to 0.33    |              |    |   |   |   | ○ | Ammo    |

## Lead Spacing

| Style | Lead Spacing |
|-------|--------------|
| E     | 7.5 mm       |

\*See the column "Rating, Dimensions & Quantity Box" for packing quantity.

Design, Specifications are subject to change without notice. Ask factory for technical specifications before purchase and/or use. Whenever a doubt about safety arises from this product, please inform us immediately for technical consultation without fail.

### ■ Rating & Dimensions

● Rated voltage : 630 VDC Capacitance tolerance :  $\pm 3\%$ (H)

| Part No.      | Cap<br>( $\mu$ F) | Dimensions (mm)  |                  |                  |                            |      |                            |                            |                  | Min. order Q'ty |                  |      |
|---------------|-------------------|------------------|------------------|------------------|----------------------------|------|----------------------------|----------------------------|------------------|-----------------|------------------|------|
|               |                   | L <sub>max</sub> | T <sub>max</sub> | H <sub>max</sub> |                            | F    | S                          |                            | G <sub>max</sub> | $\phi$ d        | Taping<br>7.5 mm | Bulk |
|               |                   |                  |                  | Straight         | Crimped lead<br>(Suffix B) |      | Crimped lead<br>(Suffix B) | Crimped lead<br>(Suffix B) |                  |                 |                  |      |
| ECWH6184HC( ) | 0.18              | 20.7             | 11.5             | 16.3             | 21.3                       | 17.5 | 10.0                       | 1.5                        | 0.8              | 250             | 1000             |      |
| ECWH6284HC( ) | 0.28              | 20.7             | 14.3             | 19.1             | 24.1                       | 17.5 | 10.0                       | 1.5                        | 0.8              | 200             | 700              |      |
| ECWH6304HC( ) | 0.30              | 20.7             | 14.8             | 19.6             | 24.6                       | 17.5 | 10.0                       | 1.5                        | 0.8              |                 |                  |      |
| ECWH6324HC( ) | 0.32              | 20.7             | 14.5             | 20.9             | 25.9                       | 17.5 | 10.0                       | 1.5                        | 0.8              |                 |                  |      |
| ECWH6334HC( ) | 0.33              | 20.7             | 14.7             | 21.1             | 26.1                       | 17.5 | 10.0                       | 1.5                        | 0.8              |                 |                  |      |

● Rated voltage : 1250 VDC Capacitance tolerance :  $\pm 5\%$ (J)

| Part No.     | Cap<br>( $\mu$ F) | Dimensions (mm)  |                  |                  |      |                  |          | Min. order Q'ty |  |
|--------------|-------------------|------------------|------------------|------------------|------|------------------|----------|-----------------|--|
|              |                   | L <sub>max</sub> | T <sub>max</sub> | H <sub>max</sub> | F    | G <sub>max</sub> | $\phi$ d | Bulk            |  |
| ECWHC3B104JA | 0.10              | 20.7             | 13.5             | 20.6             | 17.5 | 1.5              | 0.8      | 700             |  |

● Rated voltage : 3000 VDC Capacitance tolerance :  $\pm 5\%$ (J)

| Part No.       | Cap<br>( $\mu$ F) | Dimensions (mm)  |                  |                  |                            |      |                            |                            |                  | Min. order Q'ty |      |
|----------------|-------------------|------------------|------------------|------------------|----------------------------|------|----------------------------|----------------------------|------------------|-----------------|------|
|                |                   | L <sub>max</sub> | T <sub>max</sub> | H <sub>max</sub> |                            | F    | S                          |                            | G <sub>max</sub> | $\phi$ d        | Bulk |
|                |                   |                  |                  | Straight         | Crimped lead<br>(Suffix Q) |      | Crimped lead<br>(Suffix Q) | Crimped lead<br>(Suffix Q) |                  |                 |      |
| ECWHC3F242J( ) | 0.0024            | 25.8             | 6.1              | 10.9             | 17.9                       | 22.5 | 23.0                       | 1.5                        | 0.8              | 1000            |      |
| ECWHC3F362J( ) | 0.0036            | 25.8             | 7.2              | 11.9             | 18.9                       | 22.5 | 23.0                       | 1.5                        | 0.8              |                 |      |
| ECWHC3F392J( ) | 0.0039            | 25.8             | 7.5              | 12.2             | 19.2                       | 22.5 | 23.0                       | 1.5                        | 0.8              |                 |      |
| ECWHC3F432J( ) | 0.0043            | 25.8             | 6.5              | 11.2             | 18.2                       | 22.5 | 23.0                       | 1.5                        | 0.8              |                 |      |
| ECWHC3F562J( ) | 0.0056            | 25.8             | 7.3              | 12.0             | 19.0                       | 22.5 | 23.0                       | 1.5                        | 0.8              |                 |      |
| ECWHC3F822J( ) | 0.0082            | 25.8             | 7.5              | 15.3             | 22.3                       | 22.5 | 23.0                       | 1.5                        | 0.8              |                 |      |
| ECWHC3F103J( ) | 0.01              | 25.8             | 8.2              | 16.1             | 23.1                       | 22.5 | 23.0                       | 1.5                        | 0.8              |                 |      |

**ECWH (C) Type DC630V series (Metallized Polypropylene Film)**  
**Electrical Characteristics <Typical Data >**

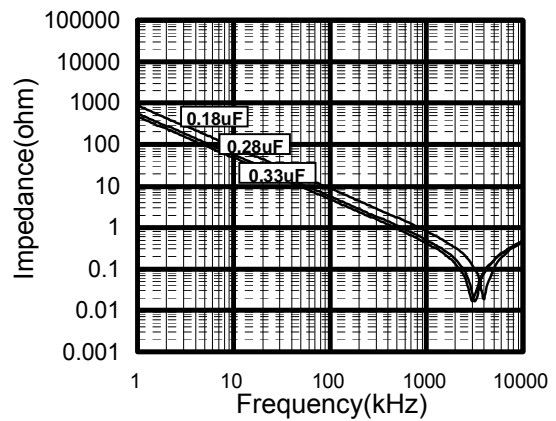
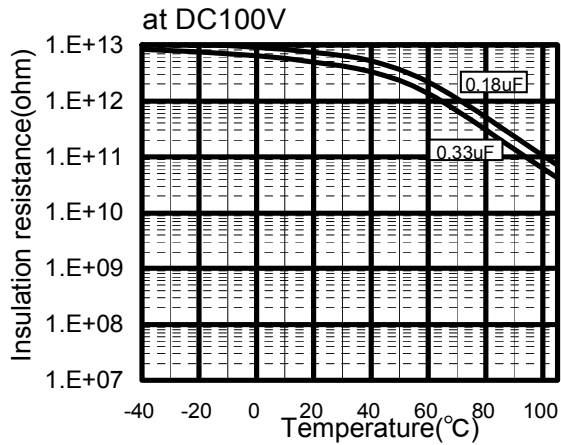
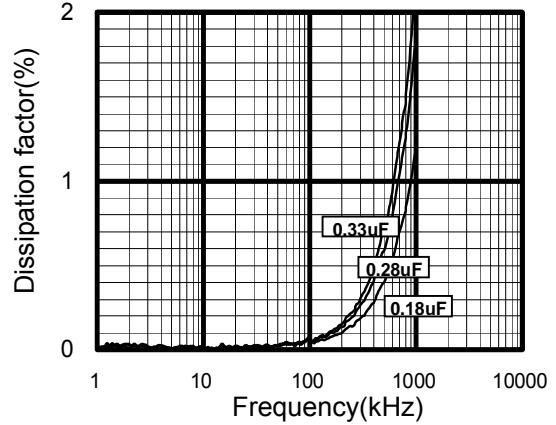
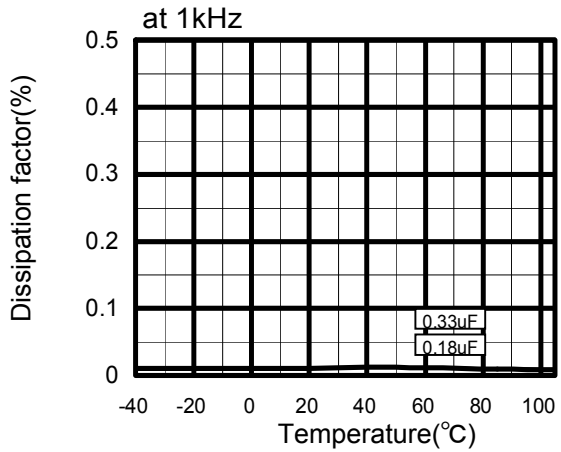
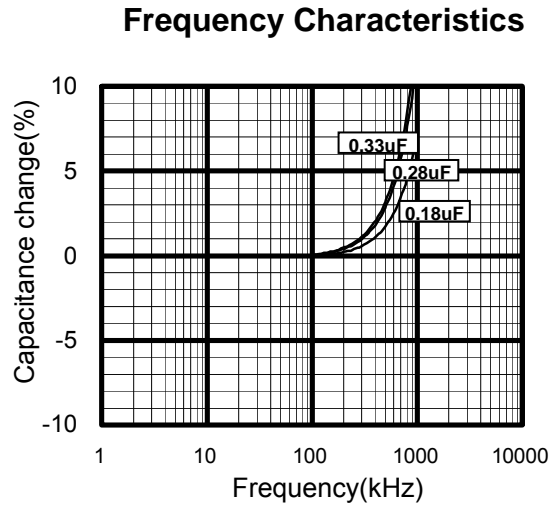
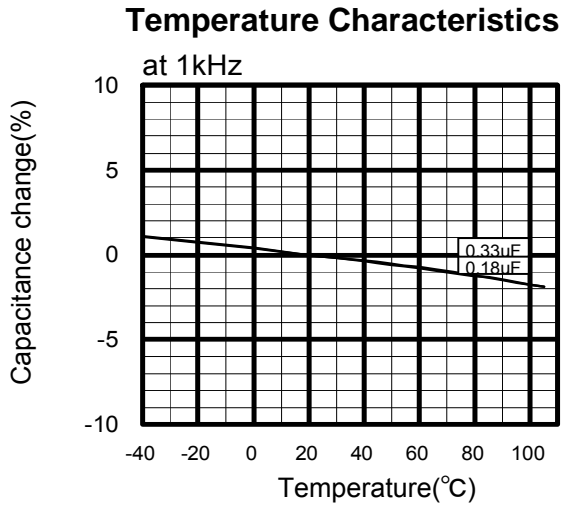

**ECWH (C) Type DC630V series (Metallized Polypropylene Film)**  
**Applicable Specifications**

**Permissible Current**

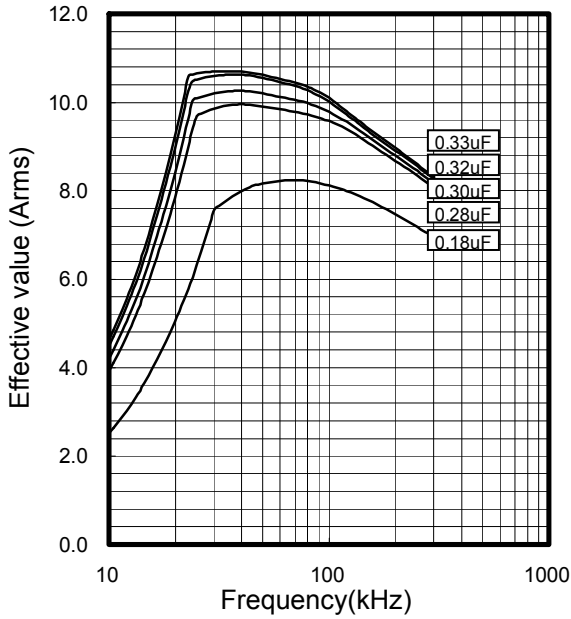

**Permissible Current Derating by Temperature**

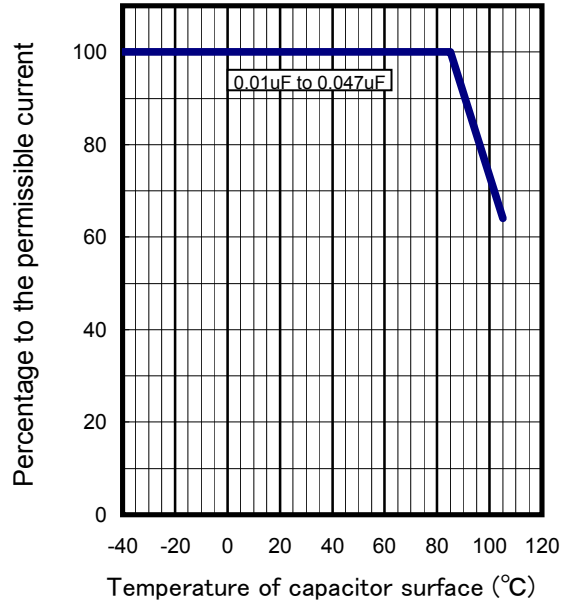

**Pulse Handling Capability (dv/dt)**  
 (Max 10000cycles)

| Rated Voltage | Capacitance (μF) | Code | dV/dt (V/μs) | Current (A0-P) |
|---------------|------------------|------|--------------|----------------|
| DC 630V       | 0.180            | 184  | 500          | 90             |
|               | 0.280            | 284  |              | 140            |
|               | 0.300            | 304  |              | 150            |
|               | 0.320            | 324  |              | 160            |
|               | 0.330            | 334  |              | 165            |

**Voltage Derating by Temperature**

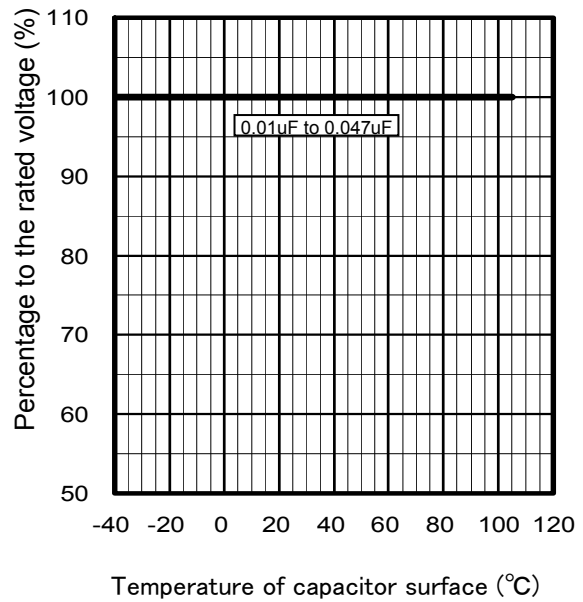

\*Please consult Panasonic if your condition exceeds the above  
 \*P When you use this product, peak voltage must not exceed DC rated voltage.  
 \*The current(0-P) value is calculated using nominal capacitance.

**ECWH (C) Type DC1250V series (Metalized Polypropylene Film)**  
**Electrical Characteristics <Typical Data 0.1 $\mu$ F >**

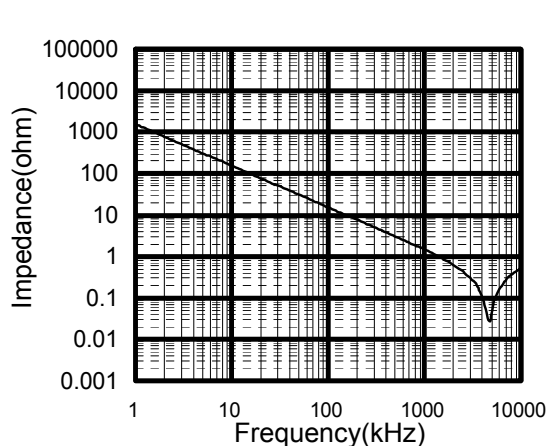
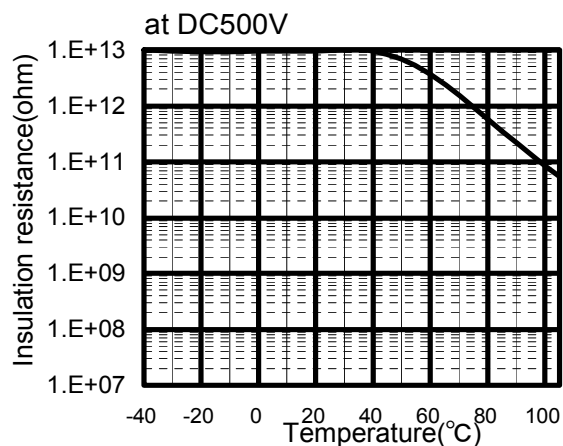
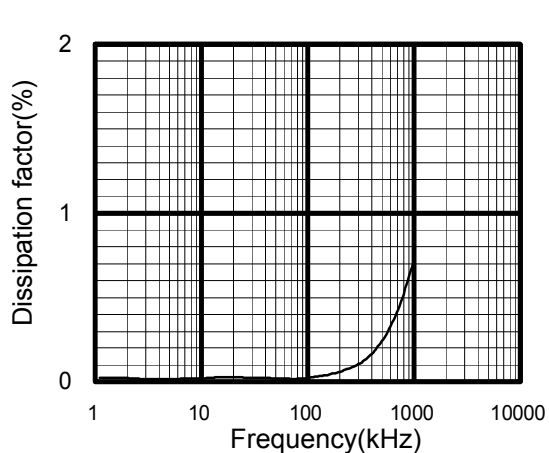
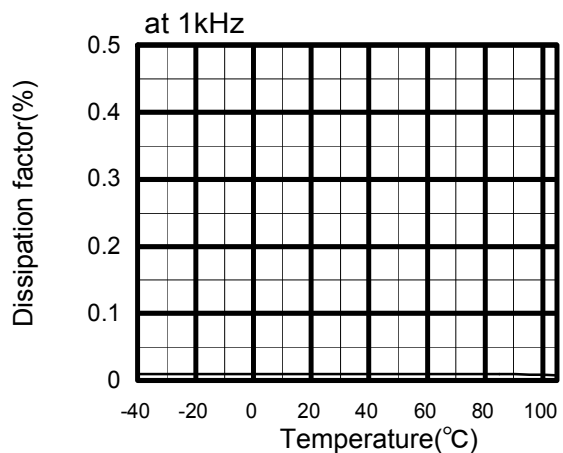
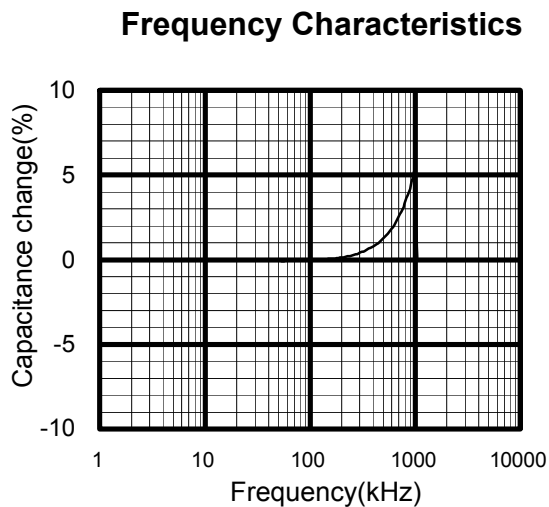
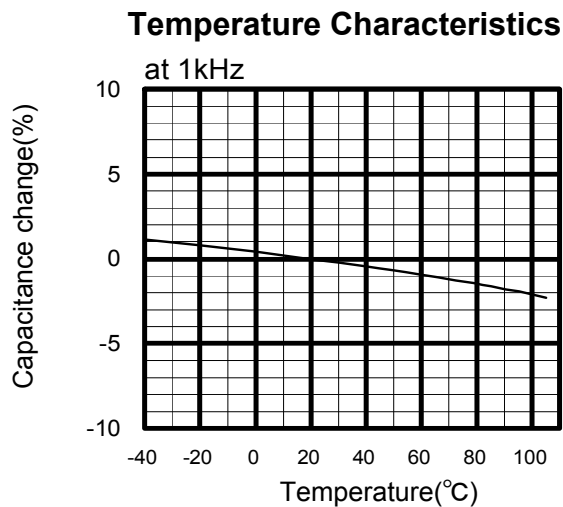

**ECWH (C) Type DC1250V series (Metallized Polypropylene Film)**  
**Applicable Specifications**

**Permissible Current**

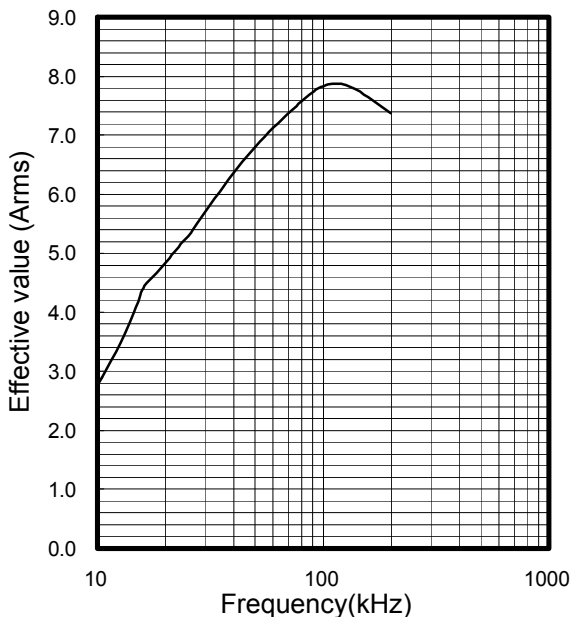

**Permissible Current Derating by Temperature**

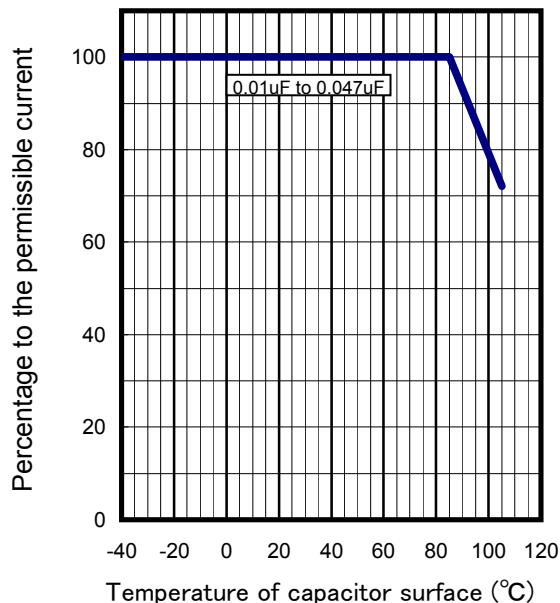

**Pulse Handling Capability (dv/dt)**  
 (Max 10000cycles)

| Rated Voltage | Capacitance (µF) | Code | dV/dt (V/µs) | Current (A0-P) |
|---------------|------------------|------|--------------|----------------|
| DC1250V       | 0.100            | 104  | 500          | 50             |

**Voltage Derating by Temperature**

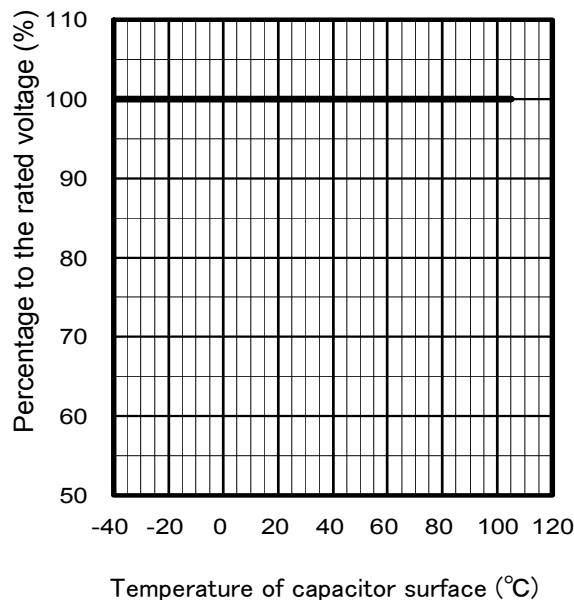

\*Please consult Panasonic if your condition exceeds the above  
 \*P When you use this product, peak voltage must not exceed DC rated voltage.  
 \*The current(0-P) value is calculated using nominal capacitance.

**ECWHC Type DC3000V series(Metallized Polypropylene Film)**  
**Electrical Characteristics <Typical Data >**

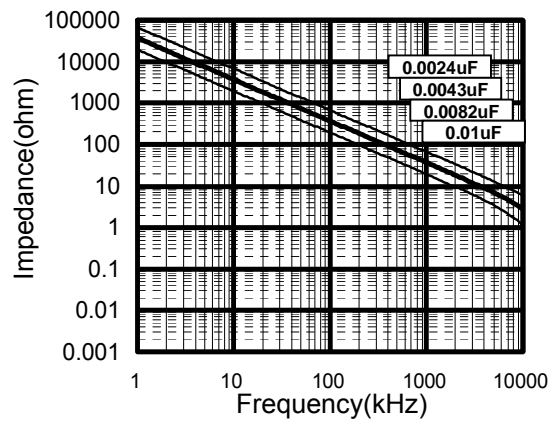
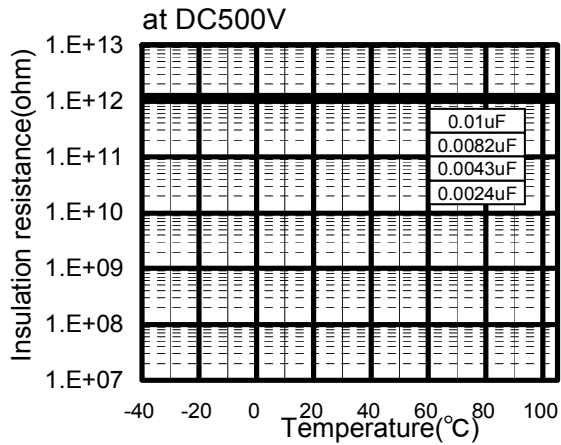
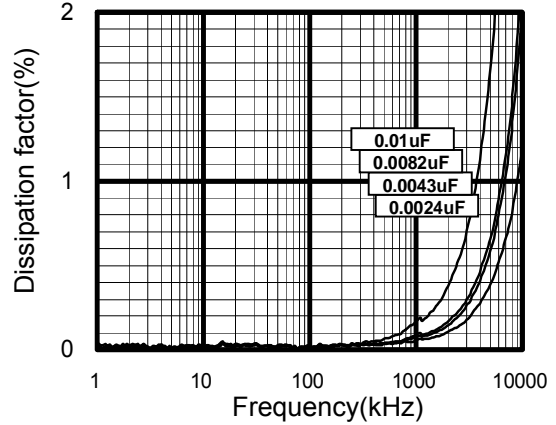
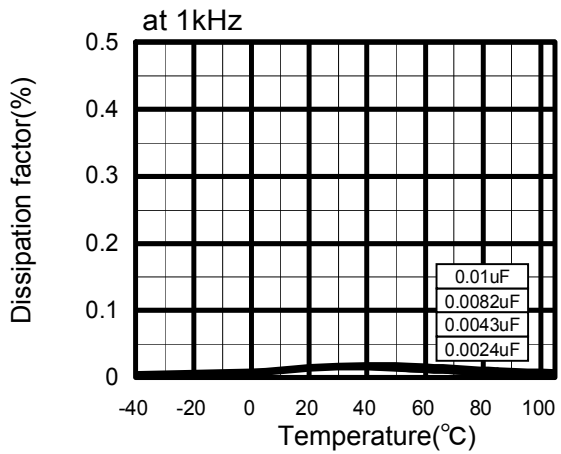
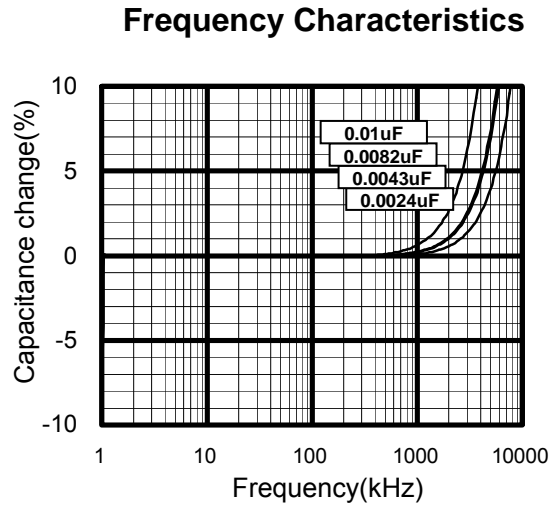
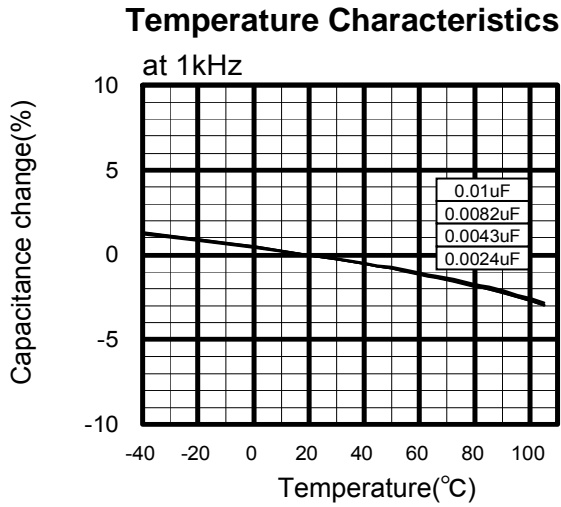



**ECWHC Type DC3000V series (Metallized Polypropylene Film)**  
**Applicable Specifications**

**Permissible Current**

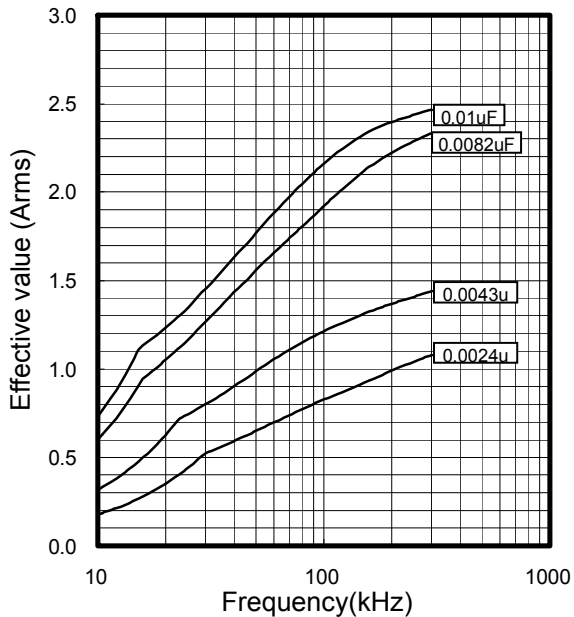

**Permissible Current Derating by Temperature**

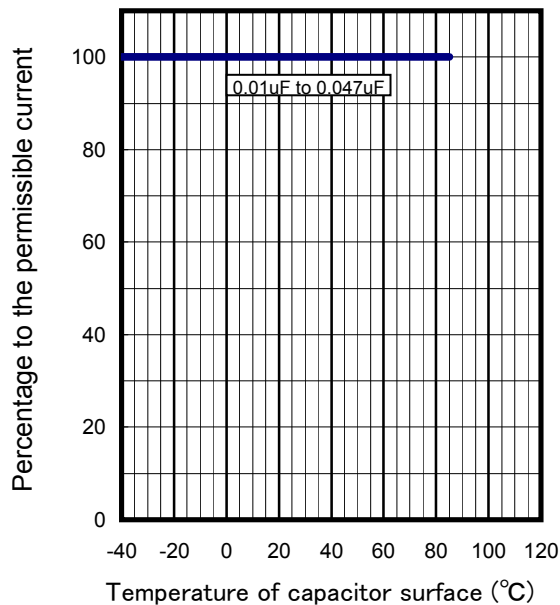

**Pulse Handling Capability (dv/dt)**  
 (Max 10000cycles)

| Rated Voltage | Capacitance ( $\mu$ F) | Code | dV/dt (V/ $\mu$ s) | Current (A0-P) |
|---------------|------------------------|------|--------------------|----------------|
| DC 3000V      | 0.0024                 | 242  | 2000               | 4.8            |
|               | 0.0036                 | 362  |                    | 7.2            |
|               | 0.0039                 | 392  |                    | 7.8            |
|               | 0.0043                 | 432  |                    | 8.6            |
|               | 0.0056                 | 562  |                    | 11.2           |
|               | 0.0082                 | 822  |                    | 16.4           |
|               | 0.0100                 | 103  |                    | 20.0           |

**Voltage Derating by Temperature**

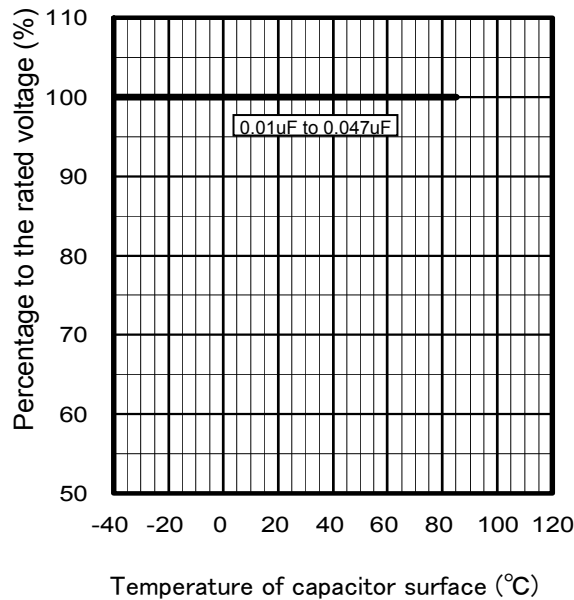

\*Please consult Panasonic if your condition exceeds the above  
 \*P When you use this product, peak voltage must not exceed DC rated voltage.  
 \*The current(0-P) value is calculated using nominal capacitance.