

QG030-148/14

# DC tangential blower

forward curved



## ebm-papst St. Georgen GmbH & Co. KG

Hermann-Papst-Straße 1

D-78112 St. Georgen

Phone +49 7724 81-0

Fax +49 7724 81-1309

info2@de.ebmpapst.com

www.ebmpapst.com

## Nominal data

Type	QG030-148/14	
Nominal voltage	VDC	24
Nominal voltage range	VDC	16 .. 28
Power input	W	6.2
Min. ambient temperature	°C	-20
Max. ambient temperature	°C	60
Air flow	m <sup>3</sup> /h	75
Sound power level	B	5.7
Sound pressure level	dB(A)	49

ml = max. load · me = max. efficiency · rfa = running at free air · cs = customer specs · cu = customer unit  
Subject to alterations



## Technical features

<b>General description</b>	<p>Particular design features:          Cross flow fan with high air flow.          Large outflow surface.</p> <p>General features:          Motor with ball bearing system. Impeller bracket with sliding bearings.          Fan housing and impeller made of aluminum, housing side parts made of plastic.          Electronic commutation completely integrated.          Protected against reverse polarity and locking.          Air discharge from the outlet.          Connection via single strands, insulated and tin-plated.          Mass: 235 / 290 / 380 / 415 g.</p>
<b>Locked-rotor protection</b>	Blocking and overload protection
<b>Direction of rotation</b>	Right, looking at rotor
<b>Bearing</b>	Motor with ball bearing system. Impeller bracket with sliding bearings.
<b>Lifetime L10 at 40 °C</b>	30000 h
<b>Lifetime L10 at maximum temperature</b>	10000 h
<b>Mass</b>	0.235 kg
<b>Housing material</b>	Aluminum, housing side parts of plastic.
<b>Material of impeller</b>	Aluminum
<b>Motor protection</b>	Protected against reverse polarity and locking.
<b>Approval</b>	VDE, CSA, UL, CE

Product drawing

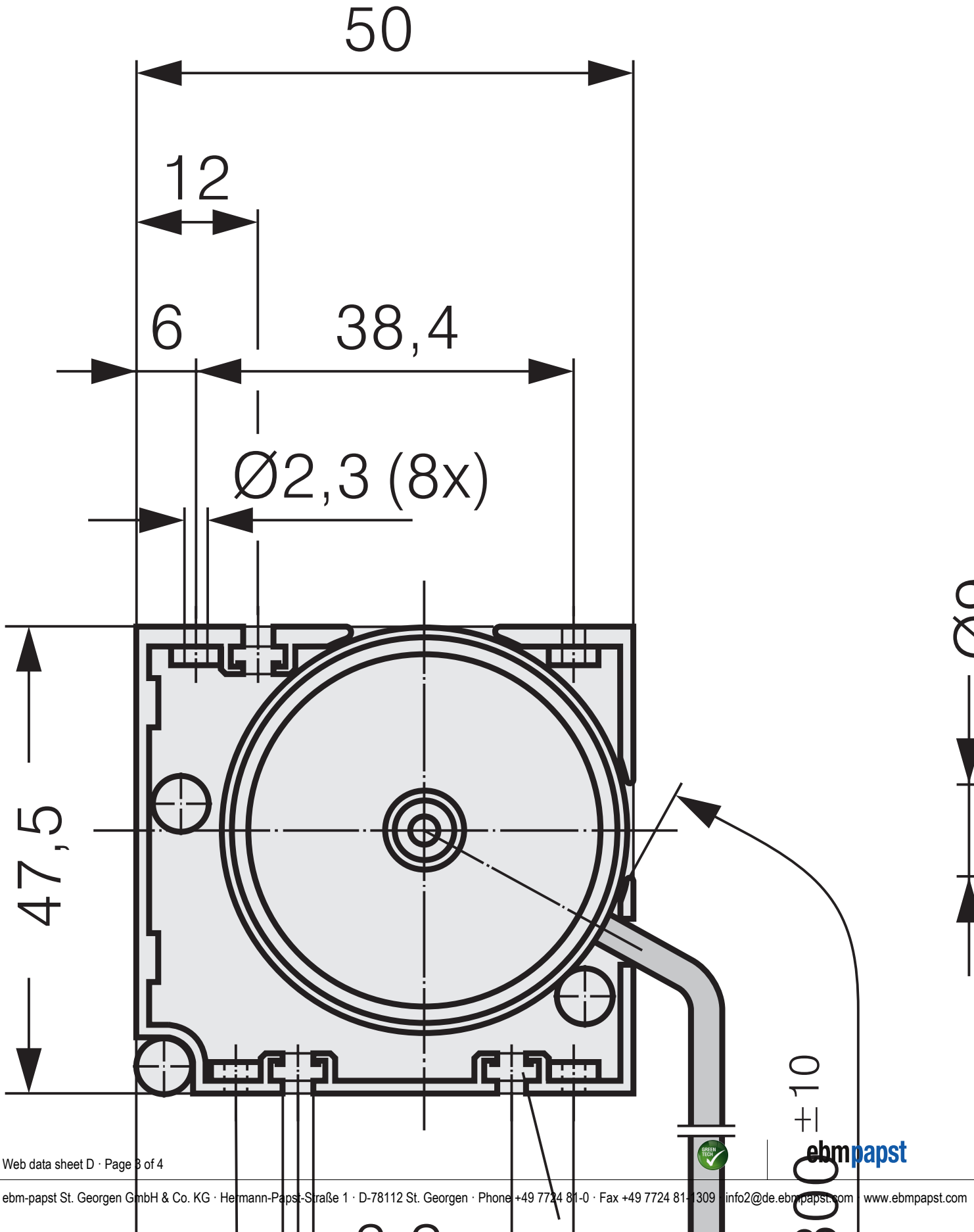

## Charts: Air flow

