

Fiber Sensor Guide Book



INDEX

■ Fiber Selection Guide	Choose by model	2
	Choose by shape/application	3
	Viewing new models	4
■ New Product Introduction	Tough Fiber	6
■ Fibers	Super Quality	8
	Threaded Type	10
	Cylindrical Type	12
	Sleeve	14
	Flat Type	16
	Small Spot	18
	Narrow Beam	19
	Wide Beam	20
	Convergent Reflective Type	21
	Retroreflective Type	22
	Chemical-resistant	23
	Heat-resistant	24
	Vacuum-resistant	26
	Liquid Leak / Liquid Detection	28
■ Fiber Options		30
■ Fiber Dimensions	Thru-beam Type	34
	Retroreflective Type	41
	Reflective Type	42
	Others	51
■ Amplifiers	FX-500 series	56
	FX-100 series	66
■ INDEX		76
■ Earlier Models Comparison Table		80

GENERAL TERMS AND CONDITIONS

Please read this document carefully with respect to our product warranty policy before using our Panasonic Electric Works SUNX products ("Products"). If you have any questions or comments regarding do's and don'ts of the Products, please consult your local Panasonic Electric Works SUNX authorized dealer for the correct use and application of the Products.

1. PRODUCT MODIFICATION & DISCONTINUANCE:

Panasonic Electric Works SUNX expressly reserves the right to modify, including the right to discontinue, any of the Products, prior to their order, from time to time without notice.

2. WARRANTIES:

- (1) Subject to the exclusions stated in 3 (EXCLUSIONS) herein below, Panasonic Electric Works SUNX warrants the Products to be free of defects in material and workmanship for a period of one (1) year from the date of shipment under normal usage in environments commonly found in manufacturing industry.
- (2) Any Products found to be defective must be shipped to Panasonic Electric Works SUNX with all shipping costs paid by Purchaser or offered to Panasonic Electric Works SUNX for inspection and examination. Upon examination by Panasonic Electric Works SUNX, Panasonic Electric Works SUNX will, at its sole discretion, repair or replace at no charge, or refund the purchase price of, any Products found to be defective.

3. EXCLUSIONS

- (1) This warranty does not apply to defects resulting from any cause:
 - (i) which was due to abuse, misuse, mishandling, improper installation, improper interfacing, or improper repair by Purchaser;
 - (ii) which was due to unauthorized modification by Purchaser, in part or in whole, whether in structure, performance or specification;
 - (iii) which was not discoverable by a person with the state-of-the-art scientific and technical knowledge at the time of manufacture;
 - (iv) which was due to an operation or use by Purchaser outside of the limits of operation or environment specified by Panasonic Electric Works SUNX;
 - (v) which was due to Force Majeure; and
 - (vi) which was due to any use or application expressly discouraged by Panasonic Electric Works SUNX in 5 (CAUTIONS FOR SAFE USE) hereunder.
- (2) This warranty extends only to the first purchaser for application, and is not transferable to any person or entity which purchased from such purchaser for application.
- (3) The performance data presented in this catalogue is only for guidance and shall not constitute any performance warranty by Panasonic Electric Works SUNX.

4. DISCLAIMERS

- (1) Panasonic Electric Works SUNX's sole obligation and liability under this warranty is limited to the repair or replacement, or refund of the purchase price, of a defective Product, at Panasonic Electric Works SUNX's option.
- (2) THE REPAIR, REPLACEMENT, OR REFUND IS THE EXCLUSIVE REMEDY OF THE PURCHASER, AND ALL OTHER WARRANTIES, EXPRESS OR IMPLIED, INCLUDING, WITHOUT LIMITATION, THE WARRANTIES OF MERCHANTABILITY, FITNESS FOR A PARTICULAR PURPOSE, AND NON-INFRINGEMENT OF PROPRIETARY RIGHTS, ARE HEREBY EXPRESSLY DISCLAIMED. IN NO EVENT SHALL PANASONIC ELECTRIC WORKS SUNX AND ITS AFFILIATED ENTITIES BE LIABLE FOR DAMAGES IN EXCESS OF THE PURCHASE PRICE OF THE PRODUCTS, OR FOR ANY INDIRECT, INCIDENTAL, SPECIAL OR CONSEQUENTIAL DAMAGES OF ANY KIND, OR ANY DAMAGES RESULTING FROM LOSS OF USE, BUSINESS INTERRUPTION, LOSS OF INFORMATION, LOSS OR INACCURACY OF DATA, LOSS OF PROFITS, LOSS OF SAVINGS, THE COST OF PROCUREMENT OF SUBSTITUTED GOODS, SERVICES OR TECHNOLOGIES, OR FOR ANY MATTER ARISING OUT OF OR IN CONNECTION WITH THE USE OR INABILITY TO USE THE PRODUCTS.

5. CAUTIONS FOR SAFE USE

- (1) The applications shown in this catalogue are only suggestions, and it is Purchaser's sole responsibility to ascertain the fitness and suitability of the Products for any particular application, as well as to abide by Purchaser's applicable local laws and regulations, if any.
- (2) Never use the Products NOT rated or designated as "SAFETY SENSOR" in any application involving risk to life or property. When such a use is made by Purchaser, such Purchaser shall indemnify and hold harmless Panasonic Electric Works SUNX from any liability or damage whatsoever arising out of or in relation to such use.
- (3) In incorporating the Products to any equipment, facilities or systems, it is highly recommended to employ fail-safe designs, including but not limited to a redundant design, flame propagation prevention design, and malfunction prevention design so as not to cause any risk of bodily injury, fire accident, or social damage due to any failure of such equipment, facilities or systems.
- (4) The Products are each intended for use only in environments commonly found in manufacturing industry, and, unless expressly allowed in this catalogue, specification or otherwise, shall not be used in, or incorporated into, any equipment, facilities or systems, such as those:
 - (a) which are used for the protection of human life or body parts;
 - (b) which are used outdoors or in environments subject to any likelihood of chemical contamination or electromagnetic influence;
 - (c) which are likely to be used beyond the limits of operations or environments specified by Panasonic Electric Works SUNX in this catalogue or otherwise;
 - (d) which may cause risk to life or property, such as nuclear energy control equipment, transportation equipment (whether on rail or land, or in air or at sea), and medical equipment;
 - (e) which are operated continuously each day for 24 hours; and
 - (f) which otherwise require a high level of safety performance similar to that required in those equipment, facilities or systems as listed in (a) through (e) above.

6. EXPORT CONTROL LAWS

In some jurisdictions, the Products may be subject to local export laws and regulations. If any diversion or re-export is to be made, Purchaser is advised to abide by such local export laws and regulations, if any, at its own responsibility.

7. PURCHASER'S TRANSFER OBLIGATIONS

If Purchaser resell or deliver the Products to a third party, Purchaser must provide such third party with a copy of this document, all specifications, manuals, catalogs, leaflets and written information of any kind provided to Purchaser by Panasonic Electric Works SUNX or its authorized local representative from time to time regarding the Products.

Fiber Selection Guide

Choose by model

◆ Thru-beam type

Model No.	Page		
	Sensing range Specifications	Dimensions	
FT-140	P.10	P.34	
FT-30	P.9		
FT-31	P.10		
FT-31S	P.15		
FT-31W	P.10		
FT-40	P.9		
FT-42	P.10		
FT-42S	P.15		
FT-42W	P.10		
FT-43			
FT-45X	P.20		
FT-A11			
FT-A11W			
FT-A32			
FT-A32W			
FT-AL05	P.35		
FT-E13			
FT-E23		P.12/P.15	
FT-F93		P.28	
FT-H13-FM2		P.24	
FT-H20-J20-S			
FT-H20-J30-S			
FT-H20-J50-S			
FT-H20-M1			
FT-H20-VJ50-S	P.36		
FT-H20-VJ80-S			
FT-H20W-M1			
FT-H30-M1V-S			P.26
FT-H35-M2			P.24
FT-H35-M2S6	P.23		
FT-HL80Y	P.19		
FT-KS40			
FT-KV26			
FT-KV40			
FT-KV40W		P.37	
FT-L80Y			
FT-R40			
FT-R41W	P.10		
FT-R42W	P.12		
FT-S11	P.9	P.38	
FT-S20			
FT-S21	P.12		
FT-S21W	P.9		
FT-S30	P.12		
FT-S31W	P.15		
FT-S32			
FT-V23			
FT-V24W			
FT-V25		P.12	
FT-V30			
FT-V40			
FT-V80Y	P.23		
FT-WZ4	P.39		
FT-WZ7			
FT-Z20HBW			
FT-Z30			
FT-Z30E			

◆ Retroreflective type

Model No.	Page	
	Sensing range Specifications	Dimensions
FR-KZ22E	P.19/P.22	P.41
FR-KZ50E		
FR-KZ50H		
FR-Z50HW		

◆ Reflective type

Model No.	Page	
	Sensing range Specifications	Dimensions
FD-30	P.9	P.42
FD-31	P.11	
FD-31W		
FD-32G	P.11/P.18	
FD-32GX		
FD-40	P.9	
FD-41	P.11	
FD-41S	P.15	
FD-41SW		
FD-41W	P.11	
FD-42G	P.11/P.18	
FD-42GW		
FD-60	P.9	P.43
FD-61	P.11	
FD-61G	P.15	
FD-61S	P.11	
FD-61W	P.20	
FD-62		
FD-64X	P.13/P.15	
FD-A16		
FD-AL11	P.11/P.18	
FD-E13		
FD-E23	P.15	
FD-EG30		
FD-EG30S	P.11/P.18	
FD-EG31		
FD-F4	P.28	
FD-F41		
FD-F41Y		
FD-F71		
FD-F8Y		
FD-FA93	P.25	
FD-H13-FM2		
FD-H18-L31		
FD-H20-21		
FD-H20-M1		

Model No.	Page		
	Sensing range Specifications	Dimensions	
FD-H25-L43	P.25	P.46	
FD-H25-L45			
FD-H30-KZ1V-S	P.26	P.47	
FD-H30-L32	P.25		
FD-H30-L32V-S	P.26		
FD-H35-20S	P.25		
FD-H35-M2			
FD-H35-M2S6	P.28		
FD-HF40Y	P.21	P.48	
FD-L10			
FD-L11			
FD-L12W			
FD-L20H			
FD-L21			
FD-L21W			
FD-L22A			
FD-L23			
FD-L30A			
FD-L31A	P.11	P.49	
FD-L32H			
FD-R60			
FD-S21			P.13
FD-S30			P.9
FD-S31	P.13		
FD-S32			
FD-S32W	P.15		
FD-S33GW			
FD-V30			
FD-V30W			
FD-V50		P.17	
FD-WZ4			
FD-WZ7			
FD-Z20HBW			
FD-Z40HBW			
FD-Z50HW	P.19		

New product introduction

Tough Fiber

Fiber Selection Guide

Choose by model

Choose by shape/application
Viewing new models

Fibers

Super Quality

Threaded Type

Cylindrical Type

Sleeve

Flat Type

Small Spot

Narrow Beam

Wide Beam

Convergent Reflective Type

Retroreflective Type

Chemical-resistant

Heat-resistant

Vacuum-resistant

Liquid Leak/Liquid Detection

Fiber Options

Fiber Dimensions

Thru-beam Type

Retroreflective Type

Reflective Type

Others

Amplifiers

FX-500 series

FX-100 series

INDEX

Earlier models comparison table

Fiber Selection Guide

Choose by quality

Super Quality

- The variance of beam intensity and beam axis is extremely small.



P.8

Choose by shape

Threaded Type

- Standard type which is mounted using nuts.



P.10

Cylindrical Type

- Has a slender shape that is mounted using set screws.



P.12

Sleeve

- Suitable for sensing in narrow locations and sensing minute objects.



P.14

Flat Type

- Thin and rectangular shape. Installed directly in narrow locations with screws.



P.16

Choose by beam shape

Small Spot

- Senses minute objects using a spot lens.



P.18

Narrow Beam

- Not easily affected by surrounding obstacles.

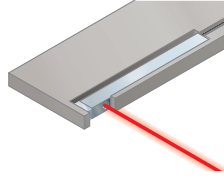

P.19

Wide Beam

- Senses in the beam band without missing a work.

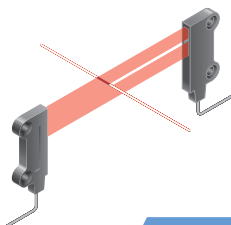

P.20

Convergent Reflective Type

- Senses in the limited range only.



P.21

Retroreflective Type

- Ideal for sensing transparent objects



P.22

Choose by environment/performance

Chemical-resistant

- Various kinds of liquids can be detected due to the fluorine contained resin case



P.23

Heat-resistant

- Withstands at -60 °C -76 °F to 350 °C 662 °F



P.24

Vacuum-resistant

- Usable in high-temperatures of 300 °C 572 °F and vacuum



P.26

Liquid Leak / Liquid Detection

- Corresponds to various liquid events.



P.28

Fiber amplifiers guidance

Digital fiber sensor FX-500 series

- At the industry's leading edge



P.56

Digital fiber sensor FX-100 series

- Super functionality, yet, economical price



P.66

New product introduction
Tough Fiber
Fiber Selection Guide
Choose by model
Choose by shape/application
Viewing new models

Fibers
Super Quality
Threaded Type
Cylindrical Type
Sleeve
Flat Type
Small Spot
Narrow Beam
Wide Beam
Convergent Reflective Type
Retroreflective Type
Chemical-resistant
Heat-resistant
Vacuum-resistant
Liquid Leak / Liquid Detection

Fiber Options
Fiber Dimensions
Thru-beam Type
Retroreflective Type
Reflective Type
Others

Amplifiers
FX-500 series
FX-100 series

INDEX

Earlier models comparison table

Fiber Selection Guide

Viewing new models

Applies to the fiber marked **NEW** in the model name field (P.8~P.29)

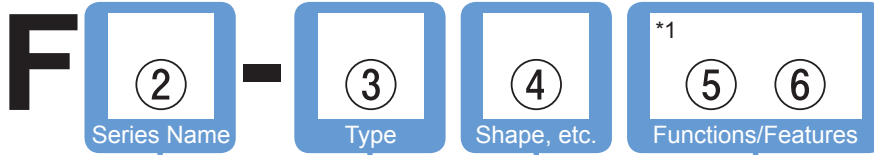

*1: Excluding liquid leak / liquid detection fiber

②

Symbol	Details
T	Thru-beam type
D	Reflective type
R	Retroreflective type

⑤

Symbol	Details
None	General-purpose
G	Coaxial reflective
S	Sleeve
H	Top sensing *
E	Side sensing *
HB	Top sensing + Bent *
A	Alignment

*③ is for Flat type (Z and KZ) only

⑥

Symbol	Details
None	General-purpose
W	Sharp bending
X	Stainless-jacketed
Y	Chemical-resistant

③		④	
Symbol	Details	Lead No.	Details
None	Treaded type	3	M3
		4	M4
		6	M6
		14	M14
R	Elbow or square head	4	M4
		6	M6
S	Cylindrical type	1	ø1 mm
		2	ø1.5 mm
		3	ø2.5 or ø3 mm
KS	Narrow beam	4	ø3.7 mm
		2	ø2 mm
V	Side-view	3	ø2.5 or ø3 mm
		4	ø4 mm
		5	ø5 mm
KV	Narrow beam / Side-view	4	ø4 mm
		2	1.5 × 2 mm
E	Ultra small diameter	1	Fiber ø0.125 mm
		2	Fiber ø0.25 mm
EG	Coaxial	3	M3
Z	Flat type	2	Thickness 2 mm
		3	Thickness 3 mm
		4	Thickness 3.5 mm
		5	Thickness 5.2 mm
		2	Thickness 2.2 mm
KZ	Narrow beam	5	Thickness 5.2 mm
		3	Sensing width 32 mm
A	Wide beam	1	Sensing width 10 to 19 mm
		1	Sensing width 11.1 mm
AL	Array	0	Sensing width 5.5 mm
		1	Sensing range 0 to 10 mm (STD)
L	Convergent reflective type	2	Sensing range 11 to 30 mm (STD)
		3	Sensing range 31mm or more (STD)
		9	Mountable on pipe
F	Liquid leak / Liquid detection	7	Liquid leak

MEMO

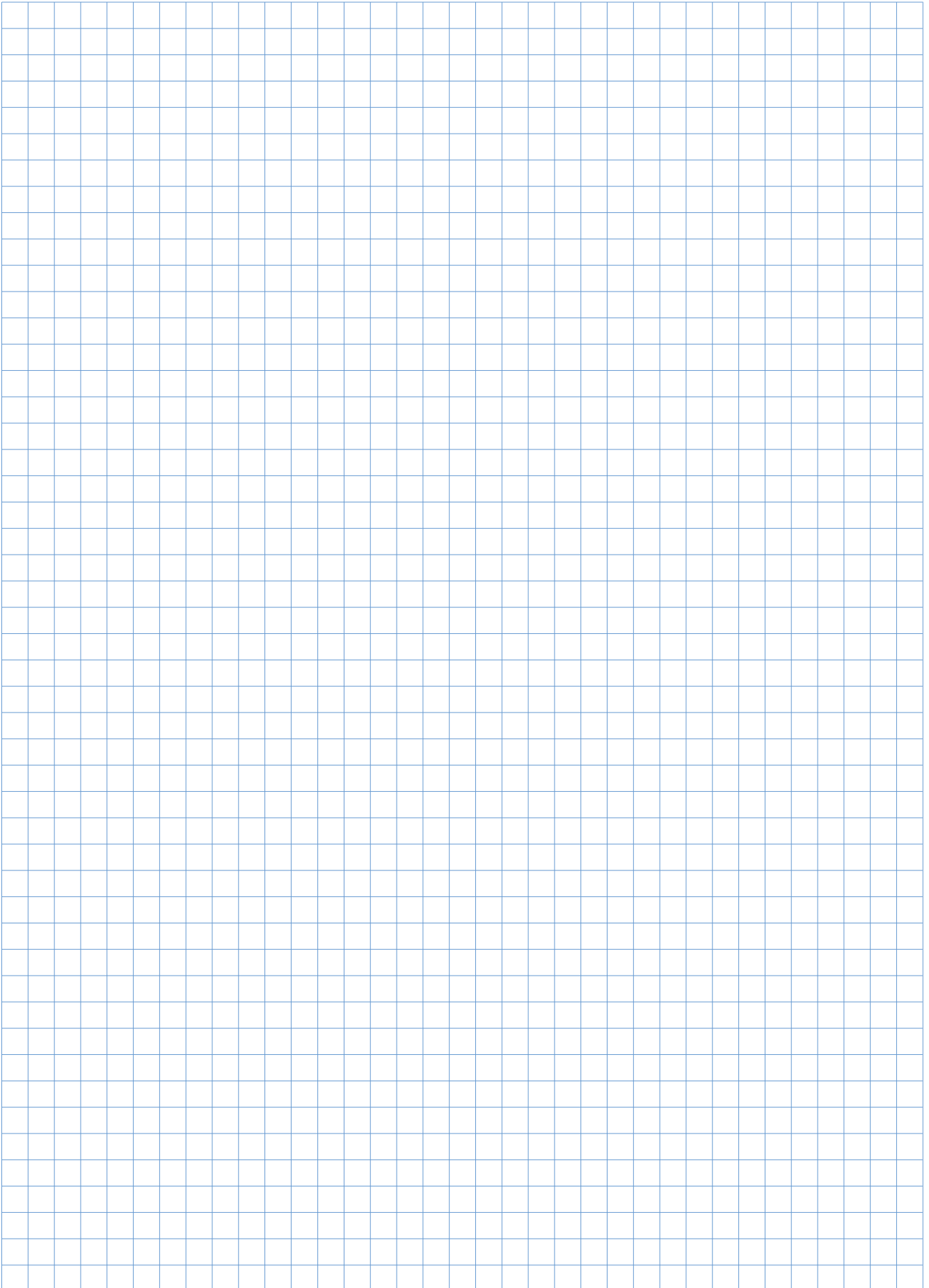

Tough Fiber

Conventional 3 types rolled into 1 !!
New standard fiber

Flexible fiber
Flexible durability

1 million
times

Sharp bending fiber
Bending radius

R2~R1
mm

General purpose fiber
Bending radius

R25
mm

in

Tough Fiber

Break-free

Flexible durability 10 million times (Typical)
Bending conditions Bending radius: R10 mm
Reciprocating bending: 180°



More flexible
Bending radius R2~R4
mm

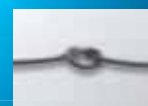

ECO

Stainless steel fittings are used
for the fiber head of all models.

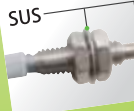

- Clearly conforms to RoHS
- Can be used for secondary battery
- Improved mounting strength

Introducing a tough fiber that transcends common knowledge!

It has toughness that can be used in moving parts, toughness that can be bent with precision, and high-quality for all purposes. It changes common knowledge about fibers.

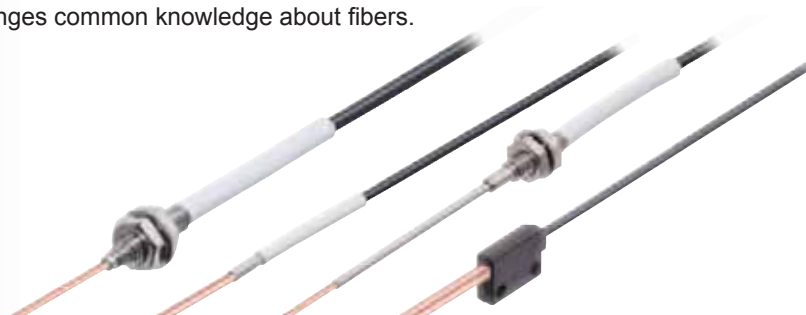

Break-free

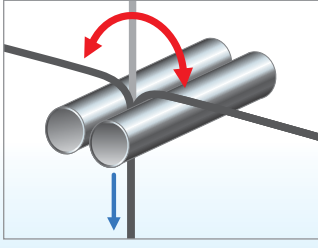

Flexible durability

10 million times

 (Typical)

Bending conditions
Bending radius: R10 mm R0.394 in, Reciprocating bending: 180°

More flexible

R2 to R4 mm R0.079 to R0.157 in

Ex) FT-31

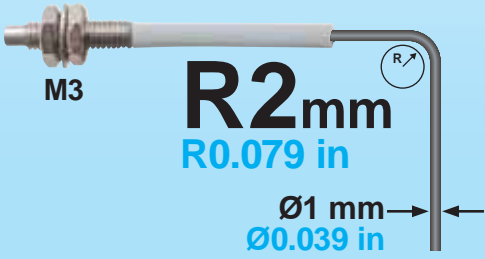

Ex) FT-42

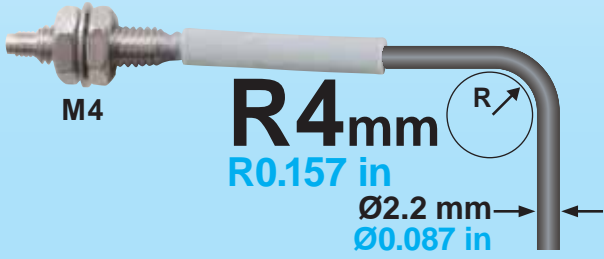

Reduced the time for selecting fiber and registration numbers

For Designers *High-quality*

- High-quality in whichever tough fiber you choose!
- Easy selection!
- Reduced risk of breaking and bending during installation!

For Buyers *Low Price*

- Cost savings!
- Reduced registration numbers!
- Reduced frequency of maintenance stockpiling and replacement!

Reduced variation in sensing

Beams at the fiber aperture are uniform, leading to stable sensing.

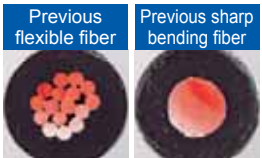

Generally flexible fibers and sharp bending fibers are composed of multiple fiber cores, often resulting in large variations in light intensity.



The new standard fiber is composed of a single fiber core, achieving uniform light intensity.
•Uniform and highly accurate sensing
•Stable sensing even if the fiber is bent

New product introduction

Tough Fiber

Fiber Selection Guide

Choose by model

Choose by shape/application

Viewing new models

Fibers

Super Quality

Threaded Type

Cylindrical Type

Sleeve

Flat Type

Small Spot

Narrow Beam

Wide Beam

Convergent Reflective Type

Retroreflective Type

Chemical-resistant

Heat-resistant

Vacuum-resistant

Liquid Leak / Liquid Detection

Fiber Options

Fiber Dimensions

Thru-beam Type

Retroreflective Type

Reflective Type

Others

Amplifiers

FX-500 series

FX-100 series

INDEX

Earlier models comparison table

Super Quality

- It is a fiber with superior light intensity stability and simple digital management when combined with the **FX-500** series amplifier.
- It offers stable sensing with an extremely small beam axis curvature and gap.

Digital management is simple due to small differences in body.

When combined with the **FX-500** series amplifiers, it has up to 4 times improved stability of incident light intensity compared with traditional fibers. Management is simple even when replacing amplifiers because the digital display shows the approximate value.

Super quality fiber + **FX-500** series

"Stabilized incident light intensities"
even in multiple units



Emitter intensity is also stable due to few curvatures and gaps in the beam axis.

Stable emission intensity within $\pm 10\%$

Variation in emission intensity of the fiber core is controlled down to less than $\pm 10\%$, achieving a stable detection.

- Beam axis deviation: Thru-beam type within $\pm 2^\circ$, Reflective type within $\pm 3^\circ$
- Beam axis centering precision: within $\pm 150 \mu\text{m}$

Expanded temperature range

Ambient temperature [-40 to $+70^\circ\text{C}$ -40 to $+158^\circ\text{F}$ in previous]

-55 to $+80^\circ\text{C}$
 -67 to $+176^\circ\text{F}$

1.2 times
more than
previous

Integrated high-precision plug

The centering precision of the fiber core attached to the inserting plug is doubled. As the insertion precision is increased, the variation among units can be greatly suppressed.



- Centering precision: within $\pm 40 \mu\text{m}$



$\varnothing 2.2 \text{ mm } \varnothing 0.087 \text{ in}$ standard fiber



Single core standard fiber with high flexibility



In general, high-flexibility types adopt a multi-fiber core which may result in large variation in light emission.

More flexible! **R4**

Bending radius [Previous is R25 mm R0.984 in]

R4 mm
R0.157 in

1/6
of that of
previous



More bendable!

Bending durability [Previous is 1,000 times]

10 million times
10,000 times
more than previous

*Bending conditions
Bending radius: R10 mm R0.39 in,
Reciprocating bending 180°

Thru-beam type (one pair set)

Type	Shape of fiber head (mm)	Model No.	Bending radius (mm)	Fiber cable length Free-cut	Sensing range (mm in)			Beam axis position/ Inclination of beam axis	Optical transmission loss	Protection	Ambient temp.
					FX-500 series	U-LG LONG FAST H-SP	FX-101 (Upper value) FX-102 (Lower value)				
Threaded	M3	Tough NEW FT-30	R2 Bending durability	2 m	STD 400 15.748 HYPR 1,350 53.150	810 31.890 650 25.591 210 8.268 75 2.953	135 5.315 400 15.748	ø0.5	±10 %	IP67	-55 to +80 °C
	M4	Tough NEW FT-40	R4 Bending durability		STD 1,200 47.244 HYPR (Note) 3,600 141.732	2,200 86.614 1,700 66.929 530 20.866 190 7.480	320 12.598 870 34.252				
Cylindrical	ø1.5	Tough NEW FT-S20	R2 Bending durability		STD 400 15.748 HYPR 1,350 53.150	810 31.890 650 25.591 210 8.268 75 2.953	135 5.315 400 15.748	ø0.5			
	ø3	Tough NEW FT-S30	R4 Bending durability		STD 1,200 47.244 HYPR (Note) 3,600 141.732	2,200 86.614 1,700 66.929 530 20.866 190 7.480	320 12.598 870 34.252	ø1			

Note: The fiber cable length practically limits the sensing range.

Reflective type

Type	Shape of fiber head (mm)	Model No.	Bending radius (mm)	Fiber cable length Free-cut	Sensing range (mm in) (Note)			Beam axis position/ Inclination of beam axis	Optical transmission loss	Protection	Ambient temp.
					FX-500 series	U-LG LONG FAST H-SP	FX-101 (Upper value) FX-102 (Lower value)				
Threaded	M3	Tough NEW FD-30	R2 Bending durability	2 m	STD 160 6.299 HYPR 600 23.622	330 12.992 250 9.843 80 3.150 25 0.984	45 1.772 155 6.102	150 µm ±3°	±10 %	IP67	-55 to +80 °C
	M4	Tough NEW FD-40	R4 Bending durability		STD 520 20.472 HYPR 1,550 61.024	900 35.433 740 29.134 260 10.236 90 3.543	140 5.512 420 16.535				
	M6	Tough NEW FD-60	R4 Bending durability		STD 160 6.299 HYPR 600 23.622	330 12.992 250 9.843 80 3.150 25 0.984	45 1.772 155 6.102				
Cylindrical	ø3	Tough NEW FD-S30	R4 Bending durability		STD 160 6.299 HYPR 600 23.622	330 12.992 250 9.843 80 3.150 25 0.984	45 1.772 155 6.102				

Note: The sensing range is specified for white non-glossy paper.

Tough : It is a fiber which possesses both unbreakable (bending radius: R10 mm, reciprocating bending: 180°) and bendable (bending radius: R4 mm or less) features.

New product introduction
Tough Fiber

Fiber Selection Guide
Choose by model
Choose by shape/application
Viewing new models

Fibers
Super Quality
Threaded Type
Cylindrical Type
Sleeve
Flat Type
Small Spot
Narrow Beam
Wide Beam
Convergent Reflective Type
Retroreflective Type
Chemical-resistant
Heat-resistant
Vacuum-resistant
Liquid Leak/Liquid Detection

Fiber Options

Fiber Dimensions
Thru-beam Type
Retroreflective Type
Reflective Type
Others

Amplifiers
FX-500 series
FX-100 series

INDEX

Earlier models comparison table

Threaded Type

- It is a standard fiber which is mounted using nuts. It has reasonable pricing while drastically improving flexing performance.
- With the lens installable type, long distance sensing and microscopic object sensing is possible by installing a lens.
- A protective tube and a sturdy stainless jacket type that prevents disconnection are also prepared.



<Thru-beam type> FT-31/31W/43/42/42W
FT-45X/R40
<Reflective type> FD-31/41/62/61/R60
More user-friendly, high quality fiber

Stainless steel fittings are used for the fiber head of all models.

- Clearly conforms to RoHS
- Can be used for secondary battery
- Improved mounting strength

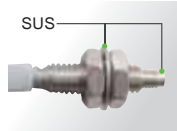

* Some models not included (FT-R41W, FT-R42W, FT-140)

Application

Metal-free fiber FT-41, FD-G60, FD-G40

- Made of resin
- Metallic particulate production ratio: ZERO
- Effect on magnetic fields: ZERO

*For details, please see our website.

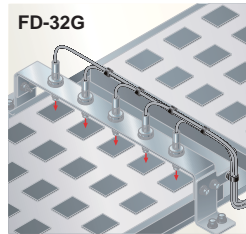

Sensing the presence of workpiece



Improved centering accuracy

The beam axis deviation of each unit is kept within $\pm 3^\circ$ and the beam axis centering accuracy is kept within $\pm 150 \mu\text{m}$.
(Within $\pm 5^\circ$ and $\pm 90 \mu\text{m}$ for ultra small diameter fibers)

- Makes beam axis adjustment easier
- Improves mounting hole machining accuracy
- Improves sensing accuracy

Improved specularity

High precision polishing is accomplished by using the PCTC polishing technique. The specularity of the end face of the fiber is 5 times greater.

- Light intensity is increased, enabling stable sensing.

Thru-beam type (one pair set)

Type	Shape of fiber head (mm)	Model No.	Bending radius (mm)	Fiber cable length (m)	Sensing range (mm in) (Note 1)			Beam axis dia. (mm)	Beam axis position/Inclination of beam axis	Protection	Ambient temp.	
					FX-500 series	U-LG LONG FAST H-SP	FX-101 (Upper value) FX-102 (Lower value)					
Threaded	M3	Tough NEW FT-31	R2	Free-cut	STD 770 30.315 315 12.402 HYPR 210 8.268 1,350 53.150	550 21.654 210 8.268 70 2.756	130 5.118 340 13.386	ø0.5	150 μm / $\pm 2^\circ$	—	-55 to +80 °C	
		NEW FT-31W	R1		STD 590 23.228 260 10.236 HYPR 150 5.906 990 38.976	440 17.323 150 5.906 53 2.087	80 3.150 240 9.449					150 μm / $\pm 3^\circ$
	M4	Lens mountable	NEW FT-43	R4	2 m	STD 2,800 110.236 1,400 55.118 HYPR (Note 2) 3,600 141.732	2,100 82.677 770 30.315 240 9.449	350 13.780 970 38.189	ø1.5	150 μm / $\pm 2^\circ$	IP67	-55 to +80 °C
			Tough NEW FT-42	R4		STD 2,050 80.709 1,130 44.488 HYPR (Note 2) 3,600 141.732	1,600 62.992 530 20.866 190 7.480	300 11.811 800 31.496				
		Lens mountable	NEW FT-42W	R1	STD 1,900 74.803 800 31.496 HYPR 1,400 55.118 490 19.291 160 6.299	1,600 62.992 (Note 2) 630 24.803 200 7.874	260 10.236 720 28.346	ø1	150 μm / $\pm 2^\circ$	-55 to +80 °C		
		Lens mountable, Stainless-jacketed	NEW FT-45X	R4	STD 1,900 74.803 800 31.496 HYPR 1,400 55.118 490 19.291 160 6.299	1,600 62.992 (Note 2) 630 24.803 200 7.874	260 10.236 720 28.346				ø1	150 μm / $\pm 2^\circ$
		Lens mountable	Tough NEW FT-R40	R4	STD 1,750 68.898 930 36.614 HYPR 1,500 59.055 500 19.685 160 6.299	1,500 59.055 500 19.685 160 6.299	270 10.630 740 29.134	ø1	150 μm / $\pm 2^\circ$	-55 to +80 °C		
		Square head	NEW FT-R41W	R1	STD 1,800 70.866 800 31.496 HYPR 1,400 55.118 460 18.110 150 5.906	1,800 70.866 1,400 55.118 460 18.110 150 5.906	250 9.843 710 27.953				ø2.2	—
		With expansion lens	NEW FT-R42W	R1	STD 3,600 141.732 (Note 2) 2,200 86.614 HYPR (Note 2) 3,600 141.732	3,500 137.795 1,300 51.181 460 18.110	510 20.079 2,000 78.740	ø10	—	IP67		
		Long range	Tough NEW FT-140	R4	STD 19,600 771.654 (Note 2) 19,600 771.654 (Note 2) HYPR (Note 2) 19,600 771.654	19,600 771.654 (Note 2) 16,000 629.921 6,300 248.031	14,000 551.181 19,600 771.654 (Note 2)				ø10	—

Notes: 1) Note that the sensing range of the free-cut type fiber may be reduced by 20 % max. depending upon how the fiber is cut.
2) The fiber cable length practically limits the sensing range.

Tough : It is a fiber which possesses both unbreakable (bending radius: R10 mm, reciprocating bending: 180°) and bendable (bending radius: R4 mm or less) features.

Coaxial type FD-□□ in which high-precision positioning can be achieved.

It is a coaxial fiber that encloses the circumference of the emitter fiber at the center with the receiver fiber. This is suitable for high-precision positioning. It can perform sensing without affecting the approach direction of the work.



Supports spot lenses and zoom lenses!

Fiber options

Lens (For thru-beam type fiber)
▶ P.30~

Lens (For reflective type fiber)
▶ P.32

Protective tube ▶ P.33

- FTP-□
- FDP-□



Reflective type

Type	Shape of fiber head (mm)	Model No.	Bending radius (mm)	Fiber cable length Free-cut	Sensing range (mm in) (Note 1, 2)			Beam axis position/Inclination of beam axis	Protection	Ambient temp.
					FX-500 series	U-LG LONG FAST H-SP	FX-101 (Upper value) FX-102 (Lower value)			
M3	M3 12	Tough NEW R2 FD-31	Bending durability	2 m	STD 125 4.921 HYPR 515 20.276	290 11.417 220 8.661 80 3.150 25 0.984	35 1.378 140 5.512	150 μm /±3°	IP67	-55 to +80 °C
		NEW R1 FD-31W			STD 80 3.150 HYPR 330 12.992	180 7.087 140 5.512 45 1.772 12 0.472	15 0.591 60 2.362	—		-40 to +60 °C
	Coaxial, Lens mountable M3 17	Tough NEW R2 FD-32G	Bending durability	1 m (Note 3)	STD 200 7.874 HYPR 650 25.591	380 14.961 270 10.630 95 3.740 27 1.063	70 2.756 190 7.480	—	IP40	-55 to +80 °C
		NEW R2 FD-32GX			STD 200 7.874 HYPR 630 24.803	410 16.142 360 14.173 100 3.937 30 1.181	75 2.953 210 8.268	—		-40 to +70 °C
	Ultra-small diameter M3 16	NEW R4 FD-EG30		500 mm	STD 48 1.890 HYPR 170 6.693	130 5.118 110 4.331 30 1.181 9 0.354	20 0.787 70 2.756	—	IP40	-40 to +70 °C
		NEW R4 FD-EG31			STD 20 0.787 HYPR 85 3.346	45 1.772 35 1.378 12 0.472 3.5 0.138	7 0.276 25 0.984	—		-20 to +60 °C
Threaded M4	M4 14	Tough NEW R2 FD-41	Bending durability	2 m	STD 125 4.921 HYPR 515 20.276	290 11.417 220 8.661 80 3.150 25 0.984	35 1.378 140 5.512	150 μm /±3°	IP67	-55 to +80 °C
		NEW R1 FD-41W			STD 270 10.630 HYPR 900 35.433	630 24.803 430 16.929 150 5.906 45 1.772	80 3.150 230 9.055	—		-40 to +60 °C
	Coaxial, Lens mountable M4 25	Tough NEW R2 FD-42G	Bending durability	2 m	STD 200 7.874 HYPR 650 25.591	380 14.961 270 10.630 95 3.740 27 1.063	70 2.756 190 7.480	—	IP40	-55 to +80 °C
		NEW R1 FD-42GW			STD 150 5.906 HYPR 670 26.378	340 13.386 280 11.024 90 3.543 25 0.984	45 1.772 140 5.512	—		-40 to +60 °C
M6	M6 17	NEW R4 FD-62	Bending durability	2 m	STD 520 20.472 HYPR 1,500 59.055	1,000 39.370 940 37.008 340 13.386 110 4.331	170 6.693 450 17.717	150 μm /±3°	IP67	-55 to +80 °C
		Tough NEW R4 FD-61			STD 450 17.717 HYPR 1,400 55.118	840 33.071 670 26.378 200 7.874 70 2.756	120 4.724 410 16.142	—		-40 to +60 °C
	Coaxial M6 17	NEW R1 FD-61W		2 m	STD 270 10.630 HYPR 900 35.433	630 24.803 430 16.929 150 5.906 45 1.772	80 3.150 230 9.055	—	IP40	-40 to +60 °C
		Tough NEW R4 FD-61G	Bending durability		STD 420 16.535 HYPR 1,100 43.307	800 31.496 650 25.591 200 7.874 60 2.362	120 4.724 350 13.780	—		-55 to +80 °C
	Stainless-jacketed M6 22	NEW R4 FD-64X		1 m	STD 280 11.024 HYPR 670 26.378	500 19.685 410 16.142 160 6.299 50 1.969	75 2.953 220 8.661	—	IP40	-55 to +80 °C
Elbow M6 15	Tough NEW R4 FD-R60	Bending durability	2 m	STD 290 11.417 HYPR 1,100 43.307	600 23.622 550 21.654 190 7.480 65 2.559	110 4.331 240 9.449	150 μm /±3°	IP67	-55 to +80 °C	

Notes: 1) Note that the sensing range of the free-cut type fiber may be reduced by 20 % max. depending upon how the fiber is cut.
2) The sensing range is specified for white non-glossy paper.
3) The allowable cutting range is 700 mm 27.559 in from the end that the amplifier is inserted.

Tough : It is a fiber which possesses both unbreakable (bending radius: R10 mm, reciprocating bending: 180°) and bendable (bending radius: R4 mm or less) features.

New product introduction
Tough Fiber
Fiber Selection Guide
Choose by model
Choose by shape/application
Viewing new models

Fibers
Super Quality
Threaded Type
Cylindrical Type
Sleeve
Flat Type
Small Spot
Narrow Beam
Wide Beam
Convergent Reflective Type
Retroreflective Type
Chemical-resistant
Heat-resistant
Vacuum-resistant
Liquid Leak / Liquid Detection

Fiber Options
Fiber Dimensions
Thru-beam Type
Retroreflective Type
Reflective Type
Others

Amplifiers
FX-500 series
FX-100 series

INDEX

Earlier models comparison table

Cylindrical Type

- Has a slender shape which can be mounted in narrow locations using set screws.
- Line up that includes ultra-thin fibers with $\phi 0.25$ mm tips.



<Thru-beam type> FT-S21/S21W/S31W <Reflective type> FD-S32/S31

- User-friendly, high quality fiber
- Improved centering accuracy and specularity

Stainless steel fittings are used for the fiber head of all models. ECO

- Clearly conforms to RoHS
- Can be used for secondary battery
- Improved mounting strength

Thru-beam type (one pair set)

Type	Shape of fiber head (mm)	Model No.	Bending radius (mm)	Fiber cable length Free-cut	Sensing range (mm in) (Note 1)			Beam axis dia. (mm)	Beam axis position/Inclination of beam axis	Protection	Ambient temp.
					FX-500 series	U-LG LONG FAST H-SP	FX-101 (Upper value) FX-102 (Lower value)				
Cylindrical	$\phi 1$	Tough NEW FT-S11	R2	500 mm	STD 190 3.543 HYPR 350 13.780	210 8.268 160 6.299 60 2.362 19 0.748	40 1.575 90 3.543	$\phi 0.25$	—	IP67	-55 to +80 °C
	$\phi 1.5$	Tough NEW FT-S21	R1	2 m	STD 315 12.402 HYPR 1,350 53.150	770 30.315 550 21.654 210 8.268 70 2.756	130 5.118 340 13.386	$\phi 0.5$	150 μm / $\pm 2^\circ$		
	$\phi 1.5$	Tough NEW FT-S21W			STD 260 10.236 HYPR 990 38.976	590 23.228 440 17.323 150 5.906 53 2.087	80 3.150 240 9.449	150 μm / $\pm 3^\circ$			
	$\phi 2.5$	Tough NEW FT-S32	R10	2 m	STD 3,100 122.047 HYPR (Note 2) 3,600 141.732	3,600 141.732 (Note 2) 3,600 141.732 (Note 2) 1,800 70.866 600 23.622	1,100 43.307 3,000 118.110	$\phi 2$	—	IP40	-40 to +70 °C
	$\phi 3$	Tough NEW FT-S31W	R1		STD 800 31.496 HYPR 3,300 129.921	1,900 74.803 1,400 55.118 490 19.291 160 6.299	260 10.236 720 28.346	$\phi 1$	150 μm / $\pm 3^\circ$	IP67	-40 to +60 °C
	Ultra-small diameter $\phi 3$	Tough NEW FT-E13	R2	1 m	STD 15 0.591 HYPR 152 2.047	30 1.181 24 0.945 8 0.315 2 0.079	6 0.236 19 0.748	$\phi 0.125$	—		
	Ultra-small diameter $\phi 3$	Tough NEW FT-E23	R2		STD 75 2.953 HYPR 270 10.630	160 6.299 125 4.921 42 1.654 13 0.512	22 0.866 80 3.150	$\phi 0.25$	—		
	Ultra-small diameter $\phi 4$	Tough NEW FT-V40	R4	2 m	STD 3,500 137.795 HYPR (Note 2) 3,600 141.732	3,600 141.732 (Note 2) 3,600 141.732 (Note 2) 2,400 94.488 850 33.465	1,000 39.370 3,100 122.047	$\phi 2.5$	—	IP50	-40 to +60 °C

Notes: 1) Note that the sensing range of the free-cut type fiber may be reduced by 20 % max. depending upon how the fiber is cut.
2) The fiber cable length practically limits the sensing range.

Tough : It is a fiber which possesses both unbreakable (bending radius: R10 mm, reciprocating bending: 180°) and bendable (bending radius: R4 mm or less) features.

New product introduction

Tough Fiber

Fiber Selection Guide

Choose by model

Choose by shape/application

Viewing new models

Fibers

Super Quality

Threaded Type

Cylindrical Type

Sleeve

Flat Type

Small Spot

Narrow Beam

Wide Beam

Convergent Reflective Type

Retroreflective Type

Chemical-resistant

Heat-resistant

Vacuum-resistant

Liquid Leak / Liquid Detection

Fiber Options

Fiber Dimensions

Thru-beam Type

Retroreflective Type

Reflective Type

Others

Amplifiers



FX-500 series

FX-100 series

INDEX

Earlier models comparison table

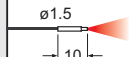
Reflective type

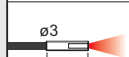
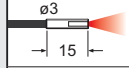
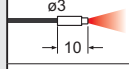
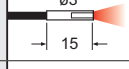
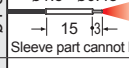
Type	Shape of fiber head (mm)	Model No.	Bending radius (mm)	Fiber cable length Free-cut	Sensing range (mm in) (Note 1, 2)			Beam axis position/ Inclination of beam axis	Protection	Ambient temp.
					FX-500 series	U-LG LONG FAST H-SP	FX-101 (Upper value) FX-102 (Lower value)			
Cylindrical	 $\phi 1.5$ 10	Tough NEW FD-S21	R2 Bending durability	1 m	STD 80 3.150 HYPR 190 7.480	130 5.118 110 4.331 37 1.457 11 0.433	25 0.984 70 2.756	—	IP40	-55 to +80 °C
	 $\phi 3$ 15	Tough NEW FD-S32	R4 Bending durability	2 m	STD 420 16.535 HYPR 1,200 47.244	790 31.102 660 25.984 220 8.661 75 2.953	120 4.724 345 13.583	150 μ m /±3°	IP67	
	 $\phi 3$ 15	NEW FD-S32W	R1		STD 270 10.630 HYPR 900 35.433	630 24.803 430 16.929 150 5.906 45 1.772	80 3.150 230 9.055	—		
	 $\phi 3$ 10	Tough NEW FD-S31	R2 Bending durability		STD 125 4.921 HYPR 515 20.276	290 11.417 220 8.661 80 3.150 25 0.984	35 1.378 140 5.512	150 μ m /±3°		
	 Coaxial $\phi 3$ 15	NEW FD-S33GW	R1		STD 150 5.906 HYPR 670 26.378	340 13.386 280 11.024 90 3.543 25 0.984	45 1.772 140 5.512	—		
	 $\phi 1.5$ $\phi 0.48$ 15 15 Sleeve part cannot be bent.	NEW FD-E13	R4		STD 12 0.472 HYPR 50 1.969	29 1.142 25 0.984 7 0.276 2 0.079	5 0.197 15 0.591	—		
 $\phi 3$ $\phi 0.63$ 15 15 Sleeve part cannot be bent.	NEW FD-E23	STD 55 2.165 HYPR 170 6.693		120 4.724 80 3.150 30 1.181 9 0.354	20 0.787 70 2.756	—	IP40	-40 to +70 °C		

Notes: 1) Note that the sensing range of the free-cut type fiber may be reduced by 20 % max. depending upon how the fiber is cut.
2) The sensing range is specified for white non-glossy paper.

Tough : It is a fiber which possesses both unbreakable (bending radius: R10 mm, reciprocating bending: 180°) and bendable (bending radius: R4 mm or less) features.

Sleeve

- It is suitable for sensing in narrow locations and sensing minute objects because the fiber tip is a thin sleeve.
- The 40 mm sleeve type can be bent in any direction.



<Thru-beam type> FT-E13/FT-E23 Ultra-small diameter fiber

Centering of 1/10 mm or less

Ultra-small diameter fibers with a compact head ensure precision centering accuracy* to stably detect minute parts.

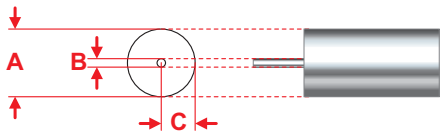

*Tolerance of A + Tolerance of B + Tolerance of C = ±0.09 mm

Dimensions UNCLEAR

Extra clearance needs to be added when designing and machining the mounting hole due to unclear dimensions. As a result, mounting variation increases and the beam axis deviates, resulting in a decrease in sensing accuracy or causing the sleeve to bend or break.

Dimensions CLEAR

Ex.) FT-E13

Highly accurate design and machining are possible due to clear mounting hole dimensions. As a result, mounting variation is minimal, improving sensing accuracy. In addition to this, as the beam axis alignment is not affected when the fiber is changed, readjustment is not necessary.

Minute sensing only possible with ultra small fiber

- Detection of fine-pitch connector pins

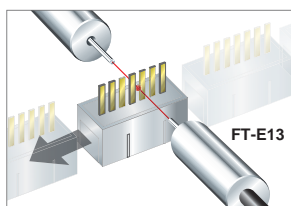

Ultra-small diameter fiber with $\varnothing 0.125\text{ mm}$ $\varnothing 0.005\text{ in}$ beam axis is able to detect the insertion or bending of fine-pitch connector pins.

- Detection of tiny chips

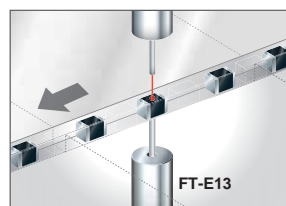

Fiber can be installed with only the $\varnothing 0.25\text{ mm}$ $\varnothing 0.010\text{ in}$ sleeve close to the minute section.

Stainless steel fittings are used for the fiber head of all models. ECO

- Clearly conforms to RoHS
- Can be used for secondary battery
- Improved mounting strength

Application

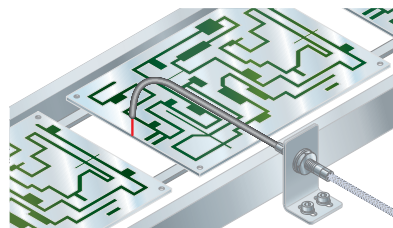

Fiber options

Fiber bender

- FB-1

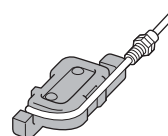

The fiber bender bends the sleeve part of the fiber head at the proper radius.

Note: Do not bend the sleeve part of any side-view type fiber or ultra-small diameter head type fiber.

Thru-beam type (one pair set)

Type	Shape of fiber head (mm)	Model No.	Bending radius (mm)	Fiber cable length Free-cut	Sensing range (mm in) (Note 1, 2)			Beam axis dia. (mm)	Protection	Ambient temp.
					FX-500 series	U-LG LONG FAST H-SP	FX-101 (Upper value) FX-102 (Lower value)			
Threaded	M3 	Tough NEW FT-31S	R2 Bending durability (Note 3)	2 m	STD 315 12.402 HYPR 1,220 48.031	740 29.134 550 21.654 195 7.677 63 2.480	130 5.118 340 13.386	∅0.5	IP67	-55 to +80 °C
	M4 	Tough NEW FT-42S	R4 Bending durability (Note 3)		STD 1,130 44.488 HYPR (Note 2) 3,600 141.732	2,050 80.709 1,600 62.992 530 20.866 190 7.480	300 11.811 800 31.496	∅1		
Cylindrical	Ultra-small diameter ∅3 	Tough NEW FT-E13	R2 Bending durability	1 m	STD 15 0.591 HYPR 52 2.047	30 1.181 24 0.945 8 0.315 2 0.079	6 0.236 19 0.748	∅0.125	IP30	-40 to +70 °C
		Tough NEW FT-E23	R4 Bending durability		STD 175 2.953 HYPR 270 10.630	160 6.299 125 4.921 42 1.654 13 0.512	22 0.866 80 3.150	∅0.25		
	Side-view ∅2 	Tough NEW FT-V23	R4 Bending durability	2 m	STD 450 17.717 HYPR 1,800 70.866	1,000 39.370 880 34.646 280 11.024 90 3.543	160 6.299 400 15.748	∅0.75	IP30	-55 to +80 °C
		Tough NEW FT-V25	R2 Bending durability		STD 240 9.449 HYPR 900 35.433	550 21.654 480 18.898 140 5.512 45 1.772	95 3.740 260 10.236	∅0.5		
	Side-view ∅2.5 	Tough NEW FT-V24W	R1	2 m	STD 110 4.331 HYPR 380 14.961	230 9.055 200 7.874 60 2.362 20 0.787	35 1.378 90 3.543	∅0.5	IP30	-40 to +60 °C
		Tough NEW FT-V30	R4 Bending durability		STD 680 26.772 HYPR 2,200 86.614	1,200 47.244 1,000 39.370 340 13.386 100 3.937	180 7.087 480 18.898	∅1.0		

Notes: 1) Note that the sensing range of the free-cut type fiber may be reduced by 20 % max. depending upon how the fiber is cut.
2) The fiber cable length practically limits the sensing range.
3) Bending radius of sleeve part is R10 mm or more.

Reflective type

Type	Shape of fiber head (mm)	Model No.	Bending radius (mm)	Fiber cable length Free-cut	Sensing range (mm in) (Note 1, 2)			Protection	Ambient temp.
					FX-500 series	U-LG LONG FAST H-SP	FX-101 (Upper value) FX-102 (Lower value)		
Threaded	Ultra-small diameter M3 	NEW FD-EG30S	R4	1 m	STD 50 1.969 HYPR 170 6.693	110 4.331 80 3.150 30 1.181 9 0.354	20 0.787 70 2.756	IP40	-40 to +70 °C
	M4 	Tough NEW FD-41S	R2 Bending durability (Note 3)		STD 125 4.921 HYPR 515 20.276	290 11.417 220 8.661 80 3.150 25 0.984	35 1.378 140 5.512	IP67	-55 to +80 °C
		NEW FD-41SW	R1 (Note 3)		STD 80 3.150 HYPR 330 12.992	180 7.087 140 5.512 45 1.772 12 0.472	15 0.591 60 2.362		
	M6 	Tough NEW FD-61S	R4 Bending durability (Note 3)		STD 420 16.535 HYPR 1,200 47.244	790 31.102 660 25.984 220 8.661 75 2.953	130 5.118 360 14.173	IP67	-55 to +80 °C
Cylindrical	Ultra-small diameter ∅1.5 	NEW FD-E13	R4	1 m	STD 12 0.472 HYPR 50 1.969	29 1.142 25 0.984 7 0.276 2 0.079	5 0.197 15 0.591	IP40	-40 to +60 °C
		NEW FD-E23			STD 55 2.165 HYPR 170 6.693	120 4.724 80 3.150 30 1.181 9 0.354	20 0.787 70 2.756		
	Side-view ∅3 	Tough NEW FD-V30	R2 Bending durability	2 m	STD 65 2.559 HYPR 240 9.449	130 5.118 120 4.724 35 1.378 14 0.551	25 0.984 75 2.953	IP30	-55 to +80 °C
		NEW FD-V30W	R1		STD 20 0.787 HYPR 80 3.150	40 1.575 30 1.181 10 0.394 2 0.079	6 0.236 20 0.787		
	Side-view ∅5 	Tough NEW FD-V50	R4 Bending durability	STD 120 4.724 HYPR 370 14.567	220 8.661 210 8.268 75 2.953 25 0.984	40 1.575 100 3.937	IP30	-55 to +80 °C	

Notes: 1) Note that the sensing range of the free-cut type fiber may be reduced by 20 % max. depending upon how the fiber is cut.
2) The sensing range is specified for white non-glossy paper.
3) Bending radius of sleeve part is R10 mm R0.394 in or more.

Tough : It is a fiber which possesses both unbreakable (bending radius: R10 mm, reciprocating bending: 180°) and bendable (bending radius: R4 mm or less) features.

New product introduction
Tough Fiber

Fiber Selection Guide
Choose by model
Choose by shape/application
Viewing new models

Fibers
Super Quality
Threaded Type
Cylindrical Type
Sleeve
Flat Type
Small Spot
Narrow Beam
Wide Beam
Convergent Reflective Type
Retroreflective Type
Chemical-resistant
Heat-resistant
Vacuum-resistant
Liquid Leak / Liquid Detection

Fiber Options

Fiber Dimensions
Thru-beam Type
Retroreflective Type
Reflective Type
Others

Amplifiers
FX-500 series
FX-100 series

INDEX

Earlier models comparison table

Flat Type

■ Since it has a thin, rectangular shape, it can be installed in narrow locations. It is also a fiber with good workability and can be mounted directly with screws.

Mounting with M2 or M3 screw

We offer; FT-WZ4/Z20HBW, FD-WZ4/Z20HBW, 1 point mounting with M2 screw and FT-WZ7/Z40HBW, FD-WZ7/Z40HBW, 1 point mounting with M3 screw.

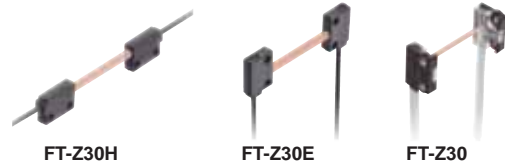
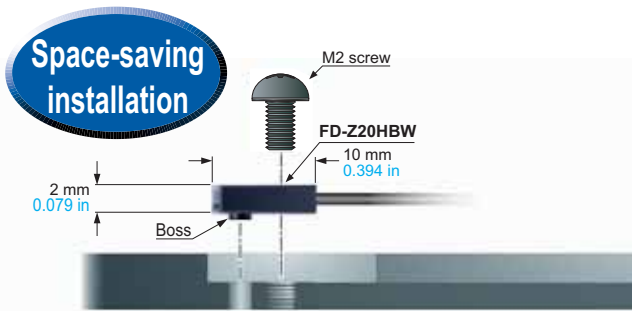

The built-in fiber guide allows for multiple installation angles.

FT/FD-WZ□HBW is equipped with a fiber guide feature. Front sensing and side sensing can be selected with one head.

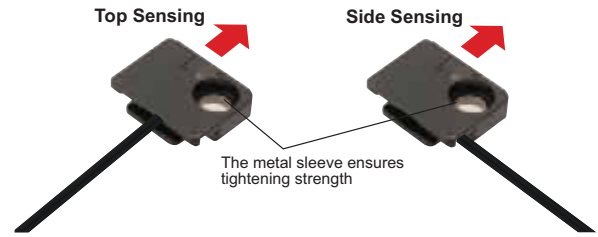

Thru-beam type (one pair set)

Type	Shape of fiber head (mm)	Model No.	Bending radius (mm)	Fiber cable length Free-cut	Sensing range (mm in) (Note 1)			Beam axis dia. (mm)	Protection	Ambient temp.
					FX-500 series	U-LG LONG FAST H-SP	FX-101 (Upper value) FX-102 (Lower value)			
Flat	Top sensing W3 × H8 × D12	Tough NEW FT-Z30H	R2 Bending durability	2 m	STD 3,500 137.795 HYPR (Note 2) 3,600 141.732	3,600 141.732 (Note 2) 3,600 141.732 (Note 2) 2,600 102.362 810 31.890	1,400 55.118 3,200 125.984	2 × 3	IP40	-40 to +60 °C
	Top sensing W3 × H8 × D12	NEW FT-Z30HW	R1		STD 3,500 137.795 HYPR (Note 2) 3,600 141.732	3,600 141.732 (Note 2) 3,600 141.732 (Note 2) 2,400 94.488 740 29.134	1,200 47.244 3,200 125.984			
	Side sensing W3 × H12 × D8	Tough NEW FT-Z30E	R2 Bending durability		STD 3,500 137.795 HYPR (Note 2) 3,600 141.732	3,600 141.732 (Note 2) 3,600 141.732 (Note 2) 2,000 78.740 630 24.803	1,200 47.244 3,200 125.984			
	Side sensing W3 × H12 × D8	NEW FT-Z30EW	R1		STD 3,400 133.858 HYPR (Note 2) 3,600 141.732	3,600 141.732 (Note 2) 3,600 141.732 (Note 2) 2,000 78.740 630 24.803	1,400 55.118 2,600 102.362			
	Front sensing W8.5 × H12 × D3	Tough NEW FT-Z30	R2 Bending durability		STD 2,100 82.677 HYPR (Note 2) 3,600 141.732	3,600 141.732 (Note 2) 3,600 141.732 (Note 2) 1,200 47.244 410 16.142	710 27.953 2,300 90.551			
	Front sensing W8.5 × H12 × D3	NEW FT-Z30W	R2		STD 1,500 59.055 HYPR (Note 2) 3,600 141.732	3,300 129.921 3,200 125.984 1,000 39.370 280 11.024	540 21.260 1,800 70.866			
	Front sensing W10 × H7 × D2	FT-WZ4	R2	STD 530 20.866 HYPR (Note 2) 1,600 62.992	1,100 43.307 900 35.433 330 12.992 100 3.937	230 9.055 670 26.378	∅1.5	—		
	Fiber bending type W2 × H10 × D10	NEW FT-Z20HBW	R1	STD 260 10.236 HYPR (Note 2) 1,100 43.307	670 26.378 570 22.441 180 7.087 55 2.165	100 3.937 320 12.598	∅0.5	IP67		
	Front sensing W14 × H7 × D3.5	FT-WZ7	R2	STD 1,400 55.118 HYPR (Note 2) 3,500 137.795	3,300 129.921 2,300 90.551 890 35.039 290 11.417	330 12.992 1,000 39.370	∅1.5	—		
	Fiber bending type W3.5 × H14 × D11	NEW FT-Z40HBW	R2	STD 800 31.496 HYPR (Note 2) 3,300 129.921	1,900 74.803 1,400 55.118 490 19.291 160 6.299	260 10.236 720 28.346	∅1	IP67		

Notes: 1) Note that the sensing range of the free-cut type fiber may be reduced by 20 % max. depending upon how the fiber is cut.
2) The fiber cable length practically limits the sensing range.

Tough : It is a fiber which possesses both unbreakable (bending radius: R10 mm, reciprocating bending: 180°) and bendable (bending radius: R4 mm or less) features.

New product introduction
 Tough Fiber
 Fiber Selection Guide
 Choose by model
 Choose by shape/application
 Viewing new models

Fibers
 Super Quality
 Threaded Type
 Cylindrical Type
 Sleeve
 Flat Type
 Small Spot
 Narrow Beam
 Wide Beam
 Convergent Reflective Type
 Retroreflective Type
 Chemical-resistant
 Heat-resistant
 Vacuum-resistant
 Liquid Leak / Liquid Detection





Fiber Options
 Fiber Dimensions
 Thru-beam Type
 Retroreflective Type
 Reflective Type
 Others

Amplifiers
 FX-500 series
 FX-100 series

INDEX

Earlier models comparison table

Reflective type

Type	Shape of fiber head (mm)	Model No.	Bending radius (mm)	Fiber cable length ✂️ : Free-cut	Sensing range (mm in) (Note 1, 2)			Protection	Ambient temp.
					FX-500 series	U-LG LONG FAST H-SP	FX-101 (Upper value) FX-102 (Lower value)		
Flat With boss	Front sensing  W10 × H7 × D2	FD-WZ4	R1	✂️ 1 m	STD 2 to 65 0.079 to 2.559 HYPR 1 to 230 0.039 to 9.055	1 to 110 0.039 to 4.331 1 to 85 0.039 to 3.346 3 to 35 0.118 to 1.378 5 to 13 0.197 to 0.512	2 to 20 0.079 to 0.787 1 to 70 0.039 to 2.756	—	-40 to +60 °C
	Fiber bending type  W2 × H10 × D10	FD-Z20HBW NEW			STD 2 to 85 0.079 to 3.346 HYPR 1 to 340 0.039 to 13.386	1 to 210 0.039 to 8.268 1 to 180 0.039 to 7.087 2 to 55 0.079 to 2.165 3 to 15 0.118 to 0.591	2 to 30 0.079 to 1.181 1 to 90 0.039 to 3.543	IP67	
	Front sensing  W14 × H7 × D3.5	FD-WZ7		✂️ 2 m	STD 110 4.331 HYPR 430 16.929	230 9.055 180 7.087 1.5 to 65 0.059 to 2.559 3 to 25 0.118 to 0.984	1 to 55 0.039 to 2.165 160 6.299	—	
	Fiber bending type  W3.5 × H14 × D11	FD-Z40HBW NEW			STD 260 10.236 HYPR 760 29.921	540 21.260 470 18.504 1 to 160 0.039 to 6.299 2 to 50 0.079 to 1.969	1 to 90 0.039 to 3.543 0.5 to 240 0.020 to 9.449	IP67	

Notes: 1) Note that the sensing range of the free-cut type fiber may be reduced by 20 % max. depending upon how the fiber is cut.
 2) The sensing range is specified for white non-glossy paper.

Small Spot

■ Sensing of minute objects can be performed by combining the fiber and spot lens. The spot diameter can also be changed.

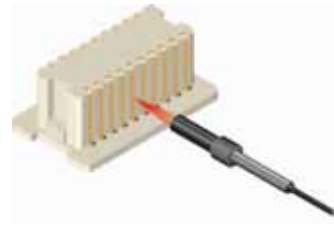

Applications

Packing detection



Because it's a side-view type, it can be mounted even in narrow spaces.

Number of IC pins checking

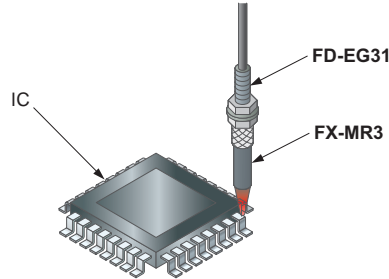

Discrimination of 0603 chip direction

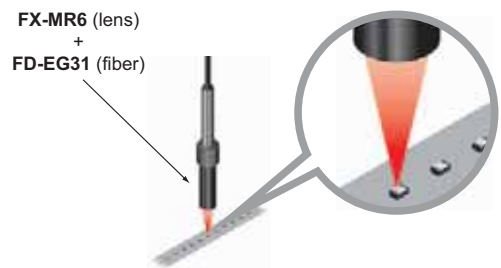

Small spot fiber lineup (High precision fiber & Spot lens)

Designation	Shape of head (mm)	Spot diameter (mm in) (Note)	Distance to focal point (mm in) (Note)	Lens		Applicable fibers											
				Model No.	Ambient temp.	Model No.	Fiber cable length ✂: Free-cut	Bending radius (mm)	Protection	Ambient temp.							
Finest spot lens		ø0.1 ø0.004	7±0.5 0.276±0.020	FX-MR6	-20 to +60 °C	NEW FD-EG31	500 mm	R4	IP40	-20 to +60 °C							
		ø0.2 ø0.008				NEW FD-EG30											
		ø0.4 ø0.016				Tough NEW FD-42G	2 m	R2 Bending durability			-55 to +80 °C						
						ø0.15 ø0.006		NEW FD-42GW			R1	-40 to +60 °C					
								Tough NEW FD-32G			R2 Bending durability	-55 to +80 °C					
		ø0.3 ø0.012				NEW FD-32GX	✂ 1 m	R2			-55 to +80 °C						
	Pinpoint spot lens					ø0.5 ø0.020	6±1 0.236±0.039	FX-MR1			-40 to +70 °C	NEW FD-EG31	500 mm	R4	IP40	-20 to +60 °C	
												NEW FD-EG30					
						ø0.3 ø0.012						Tough NEW FD-42G	2 m	R2 Bending durability			-55 to +80 °C
												NEW FD-42GW		R1			-40 to +60 °C
Zoom lens		ø0.7 to ø2.0 ø0.028 to ø0.079	Approx. 18.5 to 43 Approx. 0.728 to 1.693	FX-MR2	-40 to +70 °C	Tough NEW FD-42G	2 m	R2	-55 to +80 °C								
						NEW FD-42GW		R1	-40 to +60 °C								
Zoom lens (Side-view type)		ø0.5 to ø3.0 ø0.020 to ø0.118	Approx. 13 to 30 Approx. 0.512 to 1.181	FX-MR5	-40 to +70 °C	Tough NEW FD-42G	-	R2	-55 to +80 °C								
						NEW FD-42GW		R1	-40 to +60 °C								

Note: Spot diameter and distance to focal point are specified for FX-500/FX-100 series.

Tough : It is a fiber which possesses both unbreakable (bending radius: R10 mm, reciprocating bending: 180°) and bendable (bending radius: R4 mm or less) features.

Narrow Beam

Since the beam is narrow, it has a feature by which it is not easily affected by surrounding obstacles even in long distances.

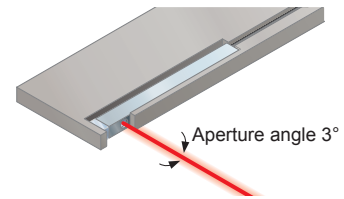

Applications



Thru-beam type (one pair set)

Type	Shape of fiber head (mm)	Model No.	Bending radius (mm)	Fiber cable length ✂: Free-cut	Sensing range (mm in) (Note 1)			Beam axis dia. (mm)	Beam axis position/Inclination of beam axis	Protection	Ambient temp.
					FX-500 series	U-LG LONG FAST H-SP	FX-101 (Upper value) FX-102 (Lower value)				
Narrow beam		Tough NEW FT-KS40	R2	2 m	STD (Note 2) 3,600 141.732	3,600 141.732 (Note 2)	2,200 86.614	ø2.2	—	IP40	-40 to +60 °C
			HYPR (Note 2) 3,600 141.732		3,600 141.732 (Note 2)	3,600 141.732 (Note 2)					
		Tough NEW FT-KV40	R2		STD (Note 2) 3,600 141.732	3,600 141.732 (Note 2)	2,200 86.614				
			HYPR (Note 2) 3,600 141.732		3,600 141.732 (Note 2)	1,200 47.244					
		Tough NEW FT-KV40W	R1	STD (Note 2) 3,600 141.732	3,600 141.732 (Note 2)	2,200 86.614	ø2.5 ±0.8°	IP30			
			HYPR (Note 2) 3,600 141.732	3,100 122.047	940 37.008						
		Tough NEW FT-KV26	R2	STD (Note 2) 710 27.953	1,600 62.992	135 5.315	ø1	X±1° Z±0.5°			
			HYPR (Note 2) 2,500 98.425	1,200 47.244	440 17.323						
					160 6.299	560 22.047					

Retroreflective type

Type	Shape of fiber head (mm)	Model No.	Bending radius (mm)	Fiber cable length ✂: Free-cut	Sensing range (mm in) (Note 1, 3)			Protection	Ambient temp.
					FX-500 series	U-LG LONG FAST H-SP	FX-101 (Upper value) FX-102 (Lower value)		
With polarizing filters		Tough NEW FR-Z50HW	R1	2 m	STD 100 to 990 0.937 to 38.976	100 to 1,400 0.937 to 55.118	100 to 550	IP40	-25 to +55 °C
			HYPR 100 to 1,900 0.937 to 74.803		100 to 1,200 0.937 to 47.244	100 to 780 0.937 to 30.709	3,937 to 21.654		
						100 to 490 0.937 to 19.291	3,937 to 32.677	100 to 830	
Wafer mapping		Tough NEW FR-KZ22E	R2		STD 15 to 310 0.591 to 12.205	15 to 460 0.591 to 18.110	15 to 200	IP30	-40 to +60 °C
					15 to 570 0.591 to 22.441	15 to 410 0.591 to 16.142	0.591 to 21.874		
						15 to 220 0.591 to 8.661	15 to 360		
Narrow beam		Tough NEW FR-KZ50H	R2		STD 20 to 300 0.787 to 11.811	20 to 800 0.787 to 31.496	20 to 200	IP30	-40 to +60 °C
					HYPR 20 to 1,000 0.787 to 39.370	20 to 400 0.787 to 15.748	0.787 to 7.874		
						20 to 200 0.787 to 7.874	20 to 350		
		Tough NEW FR-KZ50E	R2			20 to 200 0.787 to 7.874	0.787 to 13.780		

Reflective type

Type	Shape of fiber head (mm)	Model No.	Bending radius (mm)	Fiber cable length ✂: Free-cut	Sensing range (mm in) (Note 1)			Protection	Ambient temp.
					FX-500 series	U-LG LONG FAST H-SP	FX-101 (Upper value) FX-102 (Lower value)		
Long range		Tough NEW FD-Z50HW	R1	2 m	STD 10 to 650 0.394 to 25.991	10 to 1,100 0.394 to 43.307	10 to 200	IP40	-40 to +60 °C
					HYPR 10 to 2,500 0.394 to 98.425	10 to 1,000 0.394 to 39.370	0.394 to 7.874		
						10 to 410 0.394 to 16.142	10 to 830		
						15 to 130 0.591 to 5.118	0.394 to 20.866		

Notes: 1) Note that the sensing range of the free-cut type fiber may be reduced by 20 % max. depending upon how the fiber is cut.

2) The fiber cable length practically limits the sensing range.

3) The sensing range is the possible setting range for the attached reflector. The fiber can detect an object less than setting range for the reflector. Refer to P.22 for the sensing range when **FR-Z50HW** is used in combination with a reflector (optional).

Tough : It is a fiber which possesses both unbreakable (bending radius: R10 mm, reciprocating bending: 180°) and bendable (bending radius: R4 mm or less) features.

New product introduction

Tough Fiber

Fiber Selection Guide

Choose by model

Choose by shape/application

Viewing new models

Fibers

Super Quality

Threaded Type

Cylindrical Type

Sleeve

Flat Type

Small Spot

Narrow Beam

Wide Beam

Convergent Reflective Type

Retroreflective Type

Chemical-resistant

Heat-resistant

Vacuum-resistant

Liquid Leak / Liquid Detection

Fiber Options

Fiber Dimensions

Thru-beam Type

Retroreflective Type

Reflective Type

Others

Amplifiers

FX-500 series

FX-100 series

INDEX

Earlier models comparison table

Wide Beam

■ Senses work with indefinite shape or position in the beam band without missing. It can also be used to determine shape.

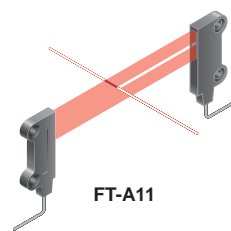

Applications

Sensing tiny moving objects Inspecting screw height Control the amount of meandering Confirming presence of slit mask

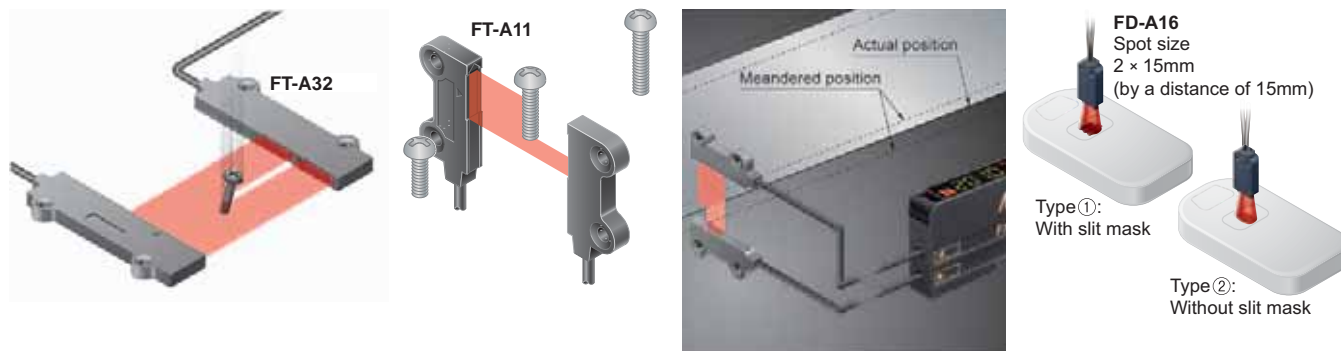

Thru-beam type (one pair set)

Type	Shape of fiber head (mm)	Model No.	Bending radius (mm)	Fiber cable length Free-cut	Sensing range (mm in) (Note 1)			Beam axis dia. (mm)	Protection	Ambient temp.
					FX-500 series	U-LG LONG FAST H-SP	FX-101 (Upper value) FX-102 (Lower value)			
Wide beam	Sensing width 32mm W5 × H69 × D20 Allows flexible wiring	Tough NEW FT-A32	R2 Bending durability	2 m	STD (Note 2) 3,600 141.732	3,600 141.732 (Note 2)	3,600 141.732 (Note 2)	3.2 × 32	IP40	-40 to +60 °C
					HYPR (Note 2) 3,600 141.732	3,600 141.732 (Note 2)				
	Sensing width 32mm W5 × H69 × D20	Tough NEW FT-A32W	R1		STD (Note 2) 3,600 141.732	3,600 141.732 (Note 2)	3,600 141.732 (Note 2)			
					HYPR (Note 2) 3,600 141.732	3,000 118.110				
Sensing width 11mm W4.2 × H31 × D13.5 Allows flexible wiring	Tough NEW FT-A11	R2 Bending durability	STD (Note 2) 3,600 141.732	3,600 141.732 (Note 2)	1,900 74.803 (Note 2)					
			HYPR (Note 2) 3,600 141.732	3,600 141.732 (Note 2)		3,600 141.732 (Note 2)				
Sensing width 11mm W4.2 × H31 × D13.5	Tough NEW FT-A11W	R1	STD (Note 2) 3,600 141.732	3,600 141.732 (Note 2)	1,700 66.929 (Note 2)					
			HYPR (Note 2) 3,600 141.732	3,600 141.732 (Note 2)		3,400 133.858				
Array Sensing width 5.5mm W5 × H15 × D15	Tough NEW FT-AL05	R2 Bending durability	STD 860 33.858	1,550 61.024	250 9.843					
			HYPR 12,300 90.551	1,500 59.055		500 19.685	660 25.984			

Notes: 1) Note that the sensing range of the free-cut type fiber may be reduced by 20 % max. depending upon how the fiber is cut.
2) The fiber cable length practically limits the sensing range to 3,600 mm 141.72 in long.

Reflective type

Type	Shape of fiber head (mm)	Model No.	Bending radius (mm)	Fiber cable length Free-cut	Sensing range (mm in) (Note 1, 2)			Protection	Ambient temp.
					FX-500 series	U-LG LONG FAST H-SP	FX-101 (Upper value) FX-102 (Lower value)		
Wide beam	W7 × H15 × D30	Tough NEW FD-A16	R4 Bending durability	2 m	STD 200 7.874 HYPR Cannot use	200 7.874 140 5.512 75 2.953	120 4.724 240 9.449	IP40	-40 to +60 °C
Array	W5 × H20 × D20	Tough NEW FD-AL11	R2 Bending durability	2 m	STD 320 12.598 HYPR 670 26.378	530 20.866 510 20.079 180 7.087 50 1.969	100 3.937 285 11.220		-55 to +80 °C

Notes: 1) Note that the sensing range of the free-cut type fiber may be reduced by 20 % max. depending upon how the fiber is cut.
2) The sensing range is specified for white non-glossy paper.

Tough : It is a fiber which possesses both unbreakable (bending radius: R10 mm, reciprocating bending: 180°) and bendable (bending radius: R4 mm or less) features.

Convergent Reflective Type

It is a fiber in which the sensing distance is limited to a specific range so it is not easily affected by the background. It is effective when work has accumulated or when the background is near.

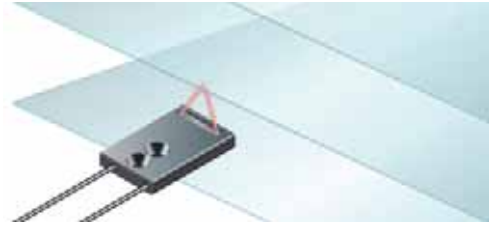

Applications

Detecting glass substrate

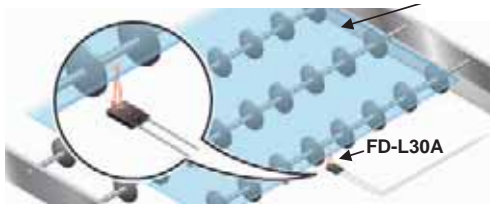

Substrate conveyors

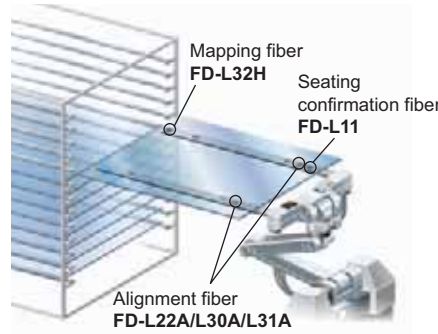

Mounting in handling arms



Reflective type

Type	Shape of fiber head (mm)	Model No.	Bending radius (mm)	Fiber cable length Free-cut	Sensing range (mm in) (Note 1, 2)			Protection	Ambient temp.
					FX-500 series	U-LG LONG FAST H-SP	FX-101 (Upper value) FX-102 (Lower value)		
Glass substrate detection	Mapping W25 × H7.3 × D30	NEW FD-L32H	R4 Bending durability	 4 m	STD 0 to 56 0 to 2.205 HYPR 0 to 110 0 to 4.331	0 to 87 0 to 3.425 0 to 74 0 to 2.913 1 to 38 0.039 to 1.496 Cannot use	16 to 30 0.630 to 1.181 0 to 50 0 to 1.969	IP40	-40 to +60 °C
	Alignment W20 × H29 × D3.8	Tough NEW FD-L30A	R2 Bending durability	 3 m	STD 0 to 43 0 to 1.693 HYPR 0 to 43 0 to 1.693	0 to 43 0 to 1.693 0 to 43 0 to 1.693 0 to 29 0 to 1.142	0 to 40 0 to 1.575 0 to 50 0 to 1.969		
	Alignment W23.5 × H29 × D4.5	Tough NEW FD-L31A	R4 Bending durability	 2 m	STD 4 to 33 0.157 to 1.299 HYPR 3 to 35 0.118 to 1.378	4 to 33 0.157 to 1.299 4 to 33 0.157 to 1.299 4 to 32 0.157 to 1.260 5 to 25 0.197 to 0.984	5 to 30 0.197 to 1.181 4 to 33 0.157 to 1.299		
	Alignment W17 × H29 × D3.8	Tough NEW FD-L22A	R2 Bending durability	 3 m	STD 0 to 24 0 to 0.945 HYPR 0 to 31 0 to 1.220	0 to 28 0 to 1.102 0 to 27 0 to 1.063 0 to 24 0 to 0.945 0 to 18 0 to 0.709	0 to 19 0 to 0.748 0 to 25 0 to 0.984		
	Seating confirmation W18 × H29 × D3.8	Tough NEW FD-L23	R2 Bending durability	 2 m	STD 0 to 29 0 to 1.142 HYPR 0 to 30 0 to 1.181	0 to 30 0 to 1.181 0 to 30 0 to 1.181 0 to 28 0 to 1.102 1.5 to 24 0.059 to 0.945	0 to 28 0 to 1.102 0 to 30 0 to 1.181		
	Seating confirmation W12 × H19 × D3	Tough NEW FD-L11	R4 Bending durability	 2 m	STD 0 to 9.5 0 to 0.374 HYPR 0 to 11.5 0 to 0.453	0 to 10.5 0 to 0.413 0 to 10 0 to 0.394 0 to 9 0 to 0.354 0 to 8 0 to 0.315	0 to 8 0 to 0.315 0 to 9 0 to 0.354		
	Seating confirmation W12 × H19 × D3	Tough NEW FD-L10	R4 Bending durability	 2 m	STD 0 to 5 0 to 0.197 HYPR 0 to 6 0 to 0.236	0 to 5.5 0 to 0.217 0 to 5 0 to 0.217 0 to 4.5 0 to 0.177 0 to 4 0 to 0.157	0 to 4.5 0 to 0.177 0 to 5.5 0 to 0.217		
	Seating confirmation W24 × H21 × D4	Tough NEW FD-L21	R2 Bending durability	 2 m	STD 1.5 to 16 0.059 to 0.630 HYPR 1 to 19 0.039 to 0.748	1 to 18 0.039 to 0.709 1 to 18 0.039 to 0.709 2 to 15 0.079 to 0.591 3 to 12 0.118 to 0.472	3 to 15 0.118 to 0.591 1.5 to 16 0.059 to 0.630		
	Seating confirmation W24 × H21 × D4	NEW FD-L21W	R1 Bending durability	 2 m	STD 3 to 14 0.118 to 0.551 HYPR 1.5 to 15 0.059 to 0.591	2 to 15 0.079 to 0.591 2 to 15 0.079 to 0.591 4 to 14 0.157 to 0.551 6.5 to 10 0.256 to 0.394	7 to 12 0.276 to 0.472 3 to 14 0.118 to 0.551		
	General purpose W6 × H18 × D14	Tough NEW FD-L20H	R2 Bending durability	 1 m	STD 23 0.906 HYPR 45 1.772	35 1.378 32 1.260 2 to 15 0.079 to 0.591 5 to 9 0.197 to 0.354	5 to 15 0.197 to 0.591 1 to 30 0.039 to 1.181		
Ultra-small W7.2 × H7.5 × D2	NEW FD-L12W	R1 Bending durability	 1 m	STD 8 0.315 HYPR 14 0.551	12.5 0.492 12 0.472 0.5 to 7 0.020 to 0.276 0.5 to 4 0.020 to 0.157	1 to 4.5 0.039 to 0.177 0.5 to 7 0.020 to 0.276	IP30 -40 to +60 °C		

Notes: 1) The sensing range is specified for transparent glass 100 × 100 × 0.7 mm 3.937 × 3.937 × 0.028 in (FD-L32H: R edge, FD-L21 and FD-L21W: t2 mm 0.079 in) (FD-L20H: white non-glossy paper, FD-L10: silicon wafers 100 × 100 mm 3.937 × 3.937 in).
2) Note that the sensing range of the free-cut type fiber may be reduced by 20 % max. depending upon how the fiber is cut.

Tough : It is a fiber which possesses both unbreakable (bending radius: R10 mm, reciprocating bending: 180°) and bendable (bending radius: R4 mm or less) features.

New product introduction

Tough Fiber

Fiber Selection Guide

Choose by model

Choose by shape/application

Viewing new models

Fibers

Super Quality

Threaded Type

Cylindrical Type

Sleeve

Flat Type

Small Spot

Narrow Beam

Wide Beam

Convergent Reflective Type

Retroreflective Type

Chemical-resistant

Heat-resistant

Vacuum-resistant

Liquid Leak / Liquid Detection

Fiber Options

Fiber Dimensions

Thru-beam Type

Retroreflective Type

Reflective Type

Others

Amplifiers

FX-500 series

FX-100 series

INDEX

Earlier models comparison table

Retroreflective Type

Compared with the thru-beam type, it is easier to rotate the fibers since one side is a reflector. Sensing transparent objects is also its advantage.



Applications

Detecting transparent film

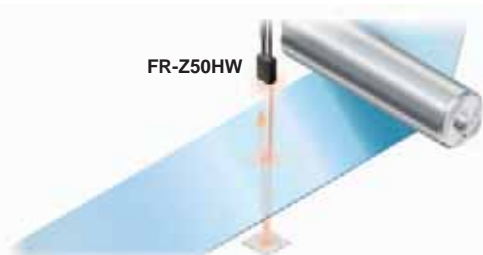

Detecting wafer



Detection of transparent seals on transparent sheet

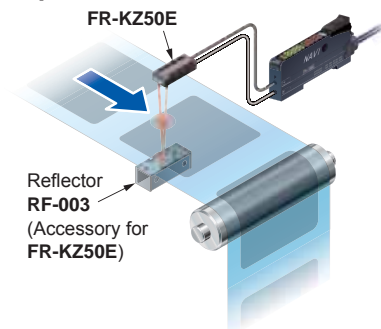

Retroreflective type

Type	Shape of fiber head (mm)	Model No.	Bending radius (mm)	Fiber cable length ✂: Free-cut	Sensing range (mm in) (Note 1, 2)			Protection	Ambient temp.
					FX-500 series	U-LG LONG FAST H-SP	FX-101 (Upper value) FX-102 (Lower value)		
With polarizing filters	W5.2 × H9.5 × D16 W30 × H30 × D0.5	FR-Z50HW NEW	R1	✂	STD	100 to 1,400 3.937 to 55.118	100 to 550	IP40	-25 to +55 °C
					HYPR	100 to 990 3.937 to 38.976 100 to 1,200 3.937 to 47.244 100 to 780 3.937 to 30.709 100 to 490 3.937 to 19.291	100 to 830 3.937 to 32.677		
Wafer mapping	W7.5 × H2.2 × D11.2 W4 × H2 × D21.5	Tough FR-KZ22E NEW	R2	✂ 2 m	STD	15 to 460 0.591 to 18.110	15 to 200	IP30	-40 to +60 °C
					HYPR	15 to 310 0.591 to 12.205 15 to 410 0.591 to 16.142 15 to 220 0.591 to 8.661 15 to 100 0.591 to 3.937	0.591 to 7.874 0.591 to 14.173		
Narrow beam Top sensing	W5.2 × H9.5 × D21 W10.6 × H28 × D10.1	Tough FR-KZ50H NEW	Bending durability	✂	STD	20 to 800 0.787 to 31.496	20 to 200	IP30	-40 to +60 °C
					HYPR	20 to 300 0.787 to 11.811 20 to 400 0.787 to 15.748 20 to 200 0.787 to 7.874 20 to 200 0.787 to 7.874	0.787 to 7.874 0.787 to 13.780		
Narrow beam Side sensing	W9.5 × H25 × D5.2 W28 × H10.6 × D10.1	Tough FR-KZ50E NEW	Bending durability	✂	STD	20 to 1,000 0.787 to 39.370	20 to 350	IP30	-40 to +60 °C
					HYPR	20 to 1,000 0.787 to 39.370	0.787 to 13.780		

Notes: 1) Note that the sensing range of the free-cut type fiber may be reduced by 20 % max. depending upon how the fiber is cut.
2) The sensing range is the possible setting range for the attached reflector. The fiber can detect an object less than setting range for the reflector.

Sensing range when FR-Z50HW is used in combination with a reflector (optional)

Reflector model No.	Sensing range (mm in)							
	FX-500 series						FX-101	FX-102
	HYPR	U-LG	LONG	STD	FAST	H-SP		
RF-230	100 to 19,000 3.937 to 748.030	100 to 8,000 3.937 to 314.960	100 to 5,000 3.937 to 196.850	100 to 3,600 3.937 to 141.732	100 to 2,900 3.937 to 114.173	100 to 1,400 3.937 to 55.118	100 to 2,400 3.937 to 94.488	100 to 5,000 3.937 to 196.850
RF-220	100 to 8,000 3.937 to 314.960	100 to 4,700 3.937 to 185.039	100 to 3,500 3.937 to 137.795	100 to 3,000 3.937 to 118.110	100 to 1,800 3.937 to 70.866	100 to 830 3.937 to 32.677	100 to 1,300 3.937 to 51.181	100 to 2,600 3.937 to 102.362
RF-210	100 to 5,500 3.937 to 216.535	100 to 2,700 3.937 to 106.299	100 to 2,400 3.937 to 94.488	100 to 1,500 3.937 to 59.055	100 to 1,200 3.937 to 47.244	100 to 530 3.937 to 20.866	100 to 980 3.937 to 38.583	100 to 1,300 3.937 to 51.181

Note: The sensing range of retroreflective type is the possible setting range for the attached reflector. The fiber can detect an object less than 100 mm. However, note that if there are any white or highly-reflective surfaces near the fiber head, reflected incident light may affect the fiber head. If this occurs, adjust the threshold value of the amplifier unit before use.

Fiber option

Reflector (for FR-Z50HW) ▶ P.33



Tough : It is a fiber which possesses both unbreakable (bending radius: R10 mm, reciprocating bending: 180°) and bendable (bending radius: R4 mm or less) features.

Chemical-resistant

With the case and fiber sheath made of PFA, the fiber can be used with various types of chemical liquids.



New product introduction
Tough Fiber
Fiber Selection Guide
Choose by model
Choose by shape/application
Viewing new models

Applications

Detecting wafer cassette in cleaning tank

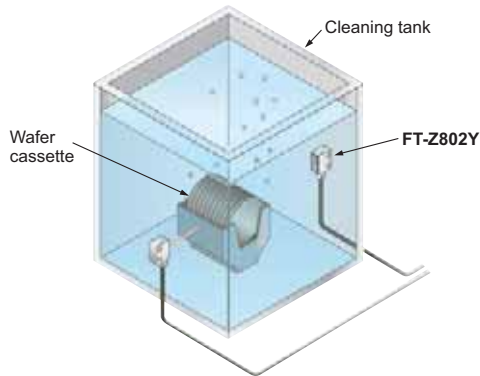

Sensing wafer in corrosive environment

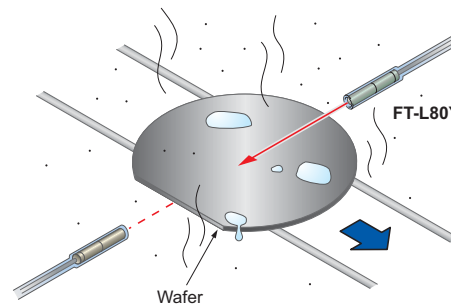

Chemical filler

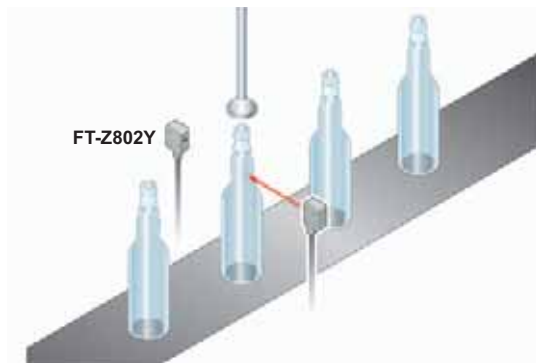

Thru-beam type (one pair set)

Type	Shape of fiber head (mm)	Model No.	Bending radius (mm)	Fiber cable length (mm) Free-cut	Sensing range (mm in) (Note 1)			Beam axis dia. (mm)	Protection	Ambient temp.
					FX-500 series	U-LG LONG FAST H-SP	FX-101 (Upper value) FX-102 (Lower value)			
Chemical-resistant	Easy mounting • Rectangular head SEMI S2 compliant W7 × H15 × D13	FT-Z802Y	R25	2 m	STD 3,100 122.047	3,600 141.732 (Note 2)	520 20.472	IP67	0 to +60 °C	
	HYPR (Note 2) 3,600 141.732				1,900 74.803	3,100 122.047				
	Heat-resistant 115 °C	FT-HL80Y	R30	2 m (Note 3)	STD (Note 2) 3,600 141.732	3,600 141.732 (Note 2)	990 38.976	IP67g	-40 to +115 °C	
	HYPR (Note 2) 3,600 141.732				2,300 90.551	2,340 92.126				
		FT-L80Y	R30	2 m (Note 3)	STD (Note 2) 3,600 141.732	3,600 141.732 (Note 2)	1,100 43.307	IP67g	-40 to +70 °C	
					HYPR (Note 2) 3,600 141.732	2,800 110.236	2,600 102.362			
	Side-view	FT-V80Y	R30	2 m (Note 3)	STD 1,300 51.181	2,800 110.236	340 13.386	IP67g	-40 to +70 °C	
					HYPR (Note 2) 3,600 141.732	2,200 86.614	800 31.496			

Notes: 1) Note that the sensing range of the free-cut type fiber may be reduced by 20 % max. depending upon how the fiber is cut.
2) The fiber cable length practically limits the sensing range.
3) The allowable cutting range is 500 mm 19.685 in from the end that the amplifier inserted.

Fibers
Super Quality
Threaded Type
Cylindrical Type
Sleeve
Flat Type
Small Spot
Narrow Beam
Wide Beam
Convergent Reflective Type
Retroreflective Type
Chemical-resistant
Heat-resistant
Vacuum-resistant
Liquid Leak / Liquid Detection

Fiber Options

Fiber Dimensions
Thru-beam Type
Retroreflective Type
Reflective Type
Others

Amplifiers
FX-500 series
FX-100 series

INDEX

Earlier models comparison table

New product introduction
Tough Fiber

Fiber Selection Guide
Choose by model
Choose by shape/application
Viewing new models

Fibers
Super Quality
Threaded Type
Cylindrical Type
Sleeve
Flat Type
Small Spot
Narrow Beam
Wide Beam
Convergent Reflective Type
Retroreflective Type
Chemical-resistant
Heat-resistant
Vacuum-resistant
Liquid Leak/Liquid Detection
Fiber Options
Fiber Dimensions
Thru-beam Type
Retroreflective Type
Reflective Type
Others
Amplifiers
FX-500 series
FX-100 series
INDEX
Earlier models comparison table

Heat-resistant

- It can be used under environments of -60 to +350 °C
-76 to +662 °F.
- A wide joint type for workability is also prepared.



Applications

IC detection within a high temperature handler Detecting glass substrates

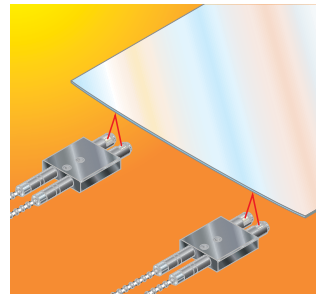
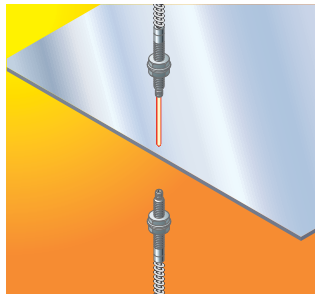
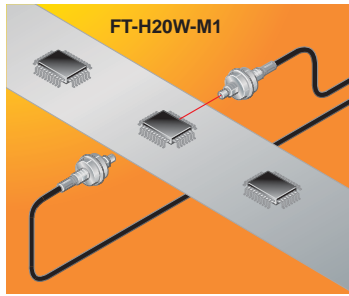

Thru-beam type (one pair set)

Type	Heat-resistant temp.	Shape of fiber head (mm)	Model No.	Bending radius (mm)	Fiber cable length ✂: Free-cut	Sensing range (mm in) (Note 1)			Beam axis dia. (mm)	Ambient temp.					
						FX-500 series	U-LG LONG FAST H-SP	FX-101 (Upper value) FX-102 (Lower value)							
Heat-resistant	350 °C	Lens mountable (FX-LE1/LE2/SV1) 	FT-H35-M2	R25	2 m	STD 430 16.929	880 34.646	170 6.693	ø1.2	-60 to +350 °C					
		Sleeve 60 mm	FT-H35-M2S6	Fiber R25 Sleeve R10		HYPR 1,200 47.244	670 26.378 250 9.843 80 3.150	490 19.291							
	200 °C	Lens mountable (FX-LE1/LE2/SV1) 	FT-H20W-M1	R10	1 m	STD 470 18.504	1,000 39.370	100 3.937	ø0.8	-60 to +200 °C					
		Lens mountable (FX-LE1/LE2/SV1) 	FT-H20-M1	R25		HYPR (Note 2) 1,600 62.992	840 33.071 300 11.811 90 3.543	300 11.811							
Heat-resistant (joint)	130 °C	Lens mountable (FX-LE2 only) 	FT-H13-FM2	R25	2 m	STD 700 27.559	1,900 74.803	250 9.843	ø1.5	-60 to +130 °C					
				HYPR 3,300 129.921		1,300 51.181 410 16.142 140 5.512	700 27.559								
	200 °C	Lens mountable (FX-LE1/LE2/SV1) 	FT-H20-J20-S (Note 5)	Heat-resistant side R18 (Note 4)	200 mm (Note 3)	✂	STD 470 18.504	1,000 39.370	135 5.315	ø1.2	-60 to +200 °C				
		Lens mountable (FX-LE1/LE2/SV1) 	FT-H20-J30-S (Note 5)									300 mm (Note 3)	HYPR 1,600 62.992	790 31.102 300 11.811 90 3.543	420 16.535
		Lens mountable (FX-LE1/LE2/SV1) 	FT-H20-J50-S (Note 5)									500 mm (Note 3)	STD 600 23.622	1,300 51.181	150 5.906
		Side-view 	FT-H20-VJ50-S (Note 5)									800 mm (Note 3)	HYPR 2,100 82.677	980 38.583 390 15.354 120 4.724	500 19.685

- Notes: 1) Note that the sensing range of the free-cut type fiber may be reduced by 20 % max. depending upon how the fiber is cut.
 2) The fiber cable length practically limits the sensing range.
 3) Fiber length (fixed-length) for heat-resistant fiber side. Fiber length for ordinary temperature side is 2 m 6.562 ft (free-cut).
 4) R25 mm R0.984 in or more for ordinary temperature side.
 5) Heat-resistant side fiber + ordinary temperature fiber (FT-FM2) are sold together as a set.

Heat-resistant joint fiber set contents

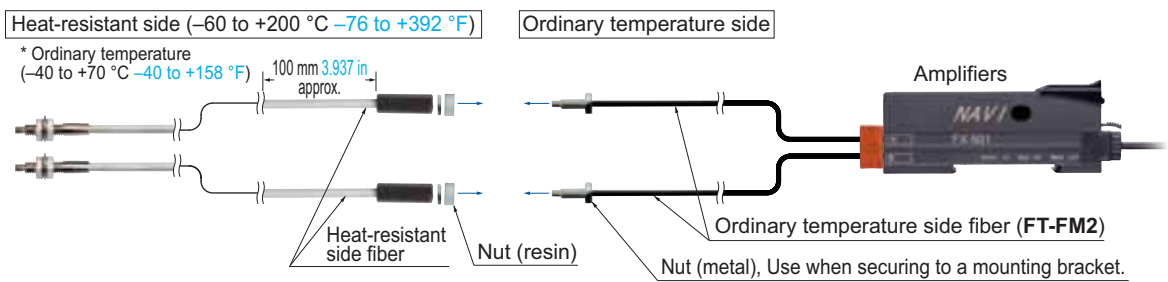

Model No. when ordering individual parts from spare parts

- Heat-resistant side fiber **one pair set**
 FT-H20-J20, FT-H20-J30, FT-H20-J50, FT-H20-VJ50, FT-H20-VJ80
- Ordinary temperature side fiber **one pair set**
 FT-FM2

Reflective type

Type	Heat-resistant temp.	Shape of fiber head (mm)	Model No.	Bending radius (mm)	Fiber cable length ✂ : Free-cut	Sensing range (mm in) (Note 1, 2)			Ambient temp.	
						FX-500 series	U-LG LONG FAST H-SP	FX-101 (Upper value) FX-102 (Lower value)		
Heat-resistant	350 °C	Coaxial M6 25	FD-H35-M2	R25	2 m	STD 260 10.236 HYPR 720 28.346	540 21.260 460 18.110 150 5.906 45 1.772	75 2.953 280 11.024	-60 to +350 °C	
		Sleeve 60 mm M6 22	FD-H35-M2S6	Fiber Sleeve R25						
		Sleeve 90 mm M4 27	FD-H35-20S	R10						
	200 °C	Coaxial M6 28	FD-H20-M1	R25	1 m	STD 330 12.992 HYPR 840 33.071	550 21.654 500 19.685 200 7.874 55 2.165	120 4.724 300 11.811	-60 to +200 °C	
		Coaxial M4 27	FD-H20-21			STD 230 9.055 HYPR 770 30.315	500 19.685 380 14.961 130 5.118 45 1.772	90 3.543 280 11.024		
	130 °C	Coaxial M6 21	FD-H13-FM2	R25	✂ 2 m	STD 350 13.780 HYPR 880 34.646	640 25.197 600 23.622 200 7.874 65 2.559	100 3.937 280 11.024	-60 to +130 °C	
	Glass substrate detection convergent reflective	300 °C	W19 × H27 × D5	FD-H30-L32	R25	2 m	STD 17 0.669 HYPR 140 1.575	30 1.181 25 0.984 12 0.472	2 to 9 0.079 to 0.354 0 to 17 0 to 0.669	-60 to +300 °C
		250 °C	W21 × H33.2 × D5	FD-H25-L43	3 m		STD 1.5 to 26 0.059 to 1.024 HYPR 1 to 31 0.039 to 1.220	1 to 30 0.039 to 1.181 1 to 28 0.039 to 1.102 1.5 to 24 0.059 to 0.945 2 to 18 0.079 to 0.709	4 to 16 0.157 to 0.630 4 to 23 0.157 to 0.906	-20 to +250 °C
			W21 × H34.5 × D5	FD-H25-L45			STD 5 to 42 0.197 to 1.654 HYPR 4 to 43.5 0.157 to 1.713	4 to 43 0.157 to 1.693 4.5 to 43 0.177 to 1.693 5 to 40 0.197 to 1.575 6.5 to 34 0.256 to 1.339	7 to 35 0.276 to 1.378 7 to 38 0.276 to 1.496	
		180 °C	W19 × H27 × D5	FD-H18-L31	R25	✂ 2 m	STD 16 0.630 HYPR 160 2.362	32 1.260 24 0.945 13 0.512 2 to 6.5 0.079 to 0.256	0 to 10 0 to 0.394 0 to 25 0 to 0.984	-60 to +180 °C

Notes: 1) The sensing range of reflective type is the value for white non-glossy paper (50 × 50 mm 1.969 × 1.969 in glass substrate for FD-H30-L32, FD-H18-L31, transparent glass 100 × 100 × t0.7 mm 3.937 × 3.937 × t0.028 in for FD-H25-L43 and FD-H25-L45).
 2) Note that the sensing range of the free-cut type fiber may be reduced by 20 % max. depending upon how the fiber is cut.

Fiber options

Lens (For thru-beam fiber) ▶ P.30~



New product introduction
Tough Fiber

Fiber Selection Guide
Choose by model
Choose by shape/application
Viewing new models

Fibers
Super Quality
Threaded Type
Cylindrical Type
Sleeve
Flat Type
Small Spot
Narrow Beam
Wide Beam
Convergent Reflective Type
Retroreflective Type
Chemical-resistant
Heat-resistant
Vacuum-resistant
Liquid Leak / Liquid Detection

Fiber Options

Fiber Dimensions

Thru-beam Type
Retroreflective Type
Reflective Type

Others

Amplifiers
FX-500 series
FX-100 series

INDEX

Earlier models comparison table

Vacuum-resistant

- Usable in high-temperatures of 300 °C 572 °F vacuum
- The leakage of **FV-BR1** is still less than a very slight $1.33 \times 10^{-10} \text{ Pa} \cdot \text{m}^3/\text{s}$ [He], so that it can be used in vacuums with confidence.

Applications

Detection of glass substrate in vacuum chamber

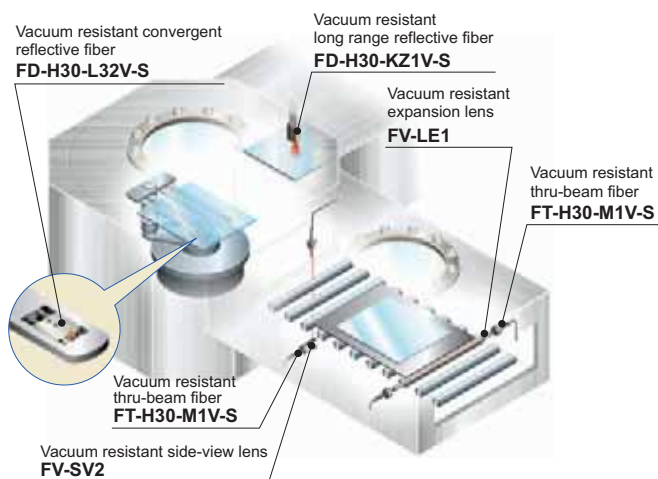

Highly resistant to repeated bending

Because it has a bending durability of over 100,000 times (R20 mm R0.79 in), it is highly resistant to repeated bending and is optimal for mounting on moving robot hand.

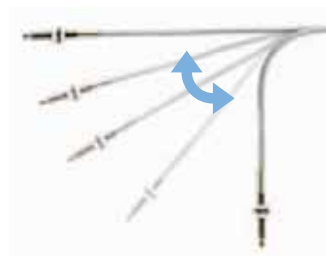

Thru-beam type (one pair set)

Type	Shape of fiber head (mm)	Model No.	Bending radius (mm)	Fiber cable length Free-cut	Sensing range (mm in)			Beam axis dia. (mm)	Ambient temp.
					FX-500 series	U-LG LONG FAST H-SP	FX-101 (Upper value) FX-102 (Lower value)		
Vacuum-resistant Thru-beam	300 °C Lens mountable (FV-LE1/SV2) M4 30	FT-H30-M1V-S (Note)	R18	1 m	STD 270 10.630 HYPR 1,000 39.370	590 23.228 470 18.504 160 6.299 55 2.165	110 4.331 280 11.024	ø1.2	-30 to +300 °C

Note: Sold as a set comprising vacuum type fiber + photo-terminal (FV-BR1) + fiber at atmospheric side (FT-J8).

Reflective type

Type	Shape of fiber head (mm)	Model No.	Bending radius (mm)	Fiber cable length Free-cut	Sensing range (mm in)(Note 2)			Ambient temp.
					FX-500 series	U-LG LONG FAST H-SP	FX-101 (Upper value) FX-102 (Lower value)	
Vacuum-resistant Reflective	300 °C, Rectangular head W9.5 × H5.2 × D15	FD-H30-KZ1V-S (Note 1)	R18	1 m	STD 20 to 200 0.787 to 7.874 HYPR 5 to 500 0.197 to 19.685	10 to 340 0.394 to 13.386 15 to 270 0.591 to 10.630 20 to 120 0.787 to 4.724 20 to 45 0.787 to 1.772	25 to 80 0.984 to 3.150 10 to 220 0.394 to 8.661	-30 to +300 °C
Vacuum-resistant Convergent reflective	300 °C, Glass substrate detection W19 × H5 × D27	FD-H30-L32V-S (Note 1)		3 m	STD 8 0.315 HYPR 18 0.709	12 0.472 10 0.394 5.5 0.217 1.5 to 3 0.059 to 0.118	2.5 to 6.5 0.098 to 0.256 0 to 11 0 to 0.433	

Notes: 1) Sold as a set comprising vacuum type fiber + photo-terminal (FV-BR1) + fiber at atmospheric side (FT-J8).

2) The sensing range of reflective type is the value for transparent glass 100 × 100 × t0.7 mm 3.937 × 3.937 × t0.028 in.

Set contents

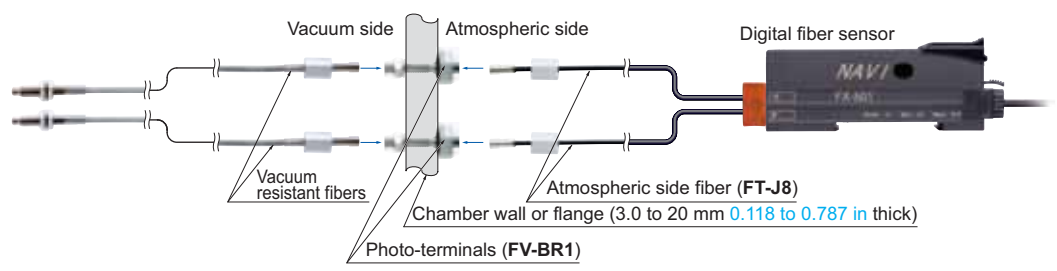

Model No. when ordering individual parts from repair parts

- Vacuum resistant fiber
FT-H30-M1V (one pair set)
FD-H30-KZ1V
FD-H30-L32V
- Photo-terminal
FV-BR1 (one pair set)
- Atmospheric side fiber
FT-J8 (one pair set)
- Mounting bracket for **FD-H30-KZ1V(-S)**
MS-FD-2

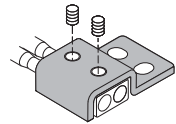

Fiber options Lens (For thru-beam fiber)

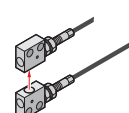
Designation	Model No.	Description																														
For thru-beam type fiber	Vacuum resistant expansion lens (Note 1)	<p>FV-LE1</p>  <p>Increases the sensing range 4 times or more. • Ambient temperature: -60 to +350 °C -76 to +662 °F (Note 3) • Beam axis dia: $\varnothing 3.6$ mm $\varnothing 0.142$ in Sensing range (mm in) [Lens on both sides] (Note 4)</p> <table border="1"> <thead> <tr> <th colspan="2">Amplifier</th> <th colspan="6">FX-500 series</th> <th>FX-101□</th> <th>FX-102□</th> </tr> <tr> <th>Fiber</th> <th>Mode</th> <th>HYPR</th> <th>U-LG</th> <th>LONG</th> <th>STD</th> <th>FAST</th> <th>H-SP</th> <th></th> <th></th> </tr> </thead> <tbody> <tr> <td>FT-H30-M1V-S</td> <td></td> <td>3,600 141.732 (Note 2)</td> <td>3,600 141.732 (Note 2)</td> <td>3,400 133.858</td> <td>1,500 59.055</td> <td>900 35.433</td> <td>370 14.567</td> <td>450 17.717</td> <td>1,600 62.992</td> </tr> </tbody> </table>	Amplifier		FX-500 series						FX-101□	FX-102□	Fiber	Mode	HYPR	U-LG	LONG	STD	FAST	H-SP			FT-H30-M1V-S		3,600 141.732 (Note 2)	3,600 141.732 (Note 2)	3,400 133.858	1,500 59.055	900 35.433	370 14.567	450 17.717	1,600 62.992
	Amplifier		FX-500 series						FX-101□	FX-102□																						
Fiber	Mode	HYPR	U-LG	LONG	STD	FAST	H-SP																									
FT-H30-M1V-S		3,600 141.732 (Note 2)	3,600 141.732 (Note 2)	3,400 133.858	1,500 59.055	900 35.433	370 14.567	450 17.717	1,600 62.992																							
Vacuum resistant side-view lens (Note 1)	<p>FV-SV2</p>  <p>Beam axis is bent by 90°. • Ambient temperature: -60 to +300 °C -76 to +572 °F (Note 3) • Beam axis dia: $\varnothing 3.7$ mm $\varnothing 0.146$ in Sensing range (mm in) [Lens on both sides] (Note 4)</p> <table border="1"> <thead> <tr> <th colspan="2">Amplifier</th> <th colspan="6">FX-500 series</th> <th>FX-101□</th> <th>FX-102□</th> </tr> <tr> <th>Fiber</th> <th>Mode</th> <th>HYPR</th> <th>U-LG</th> <th>LONG</th> <th>STD</th> <th>FAST</th> <th>H-SP</th> <th></th> <th></th> </tr> </thead> <tbody> <tr> <td>FT-H30-M1V-S</td> <td></td> <td>3,600 141.732 (Note 2)</td> <td>3,600 141.732 (Note 2)</td> <td>3,400 133.858</td> <td>1,500 59.055</td> <td>900 35.433</td> <td>370 14.567</td> <td>450 17.717</td> <td>1,600 62.992</td> </tr> </tbody> </table>	Amplifier		FX-500 series						FX-101□	FX-102□	Fiber	Mode	HYPR	U-LG	LONG	STD	FAST	H-SP			FT-H30-M1V-S		3,600 141.732 (Note 2)	3,600 141.732 (Note 2)	3,400 133.858	1,500 59.055	900 35.433	370 14.567	450 17.717	1,600 62.992	
Amplifier		FX-500 series						FX-101□	FX-102□																							
Fiber	Mode	HYPR	U-LG	LONG	STD	FAST	H-SP																									
FT-H30-M1V-S		3,600 141.732 (Note 2)	3,600 141.732 (Note 2)	3,400 133.858	1,500 59.055	900 35.433	370 14.567	450 17.717	1,600 62.992																							

- Notes: 1) Be careful when installing the thru-beam type fiber equipped with the lens, as the beam envelope becomes narrow and alignment is difficult.
 2) The fiber cable length practically limits the sensing range.
 3) Refer to P.26 for the ambient temperature of fibers to be used in combination.
 4) The fiber cable length for the **FT-H30-M1V-S** is 1 m **3.281 ft**. The sensing ranges in HYPR, U-LG and LONG of **FX-500** series, in **FX-102□** take into account the length of the **FT-J8** atmospheric side fiber.

Liquid Leak / Liquid Detection

It corresponds to various liquid events, from the contact (wetted) type to the pipe mounting type, and up to leak detection.

Applications

Detecting liquid level in a tank

Leak detection for use in semiconductor device manufacturing

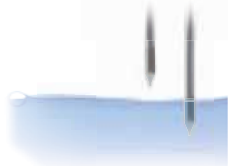
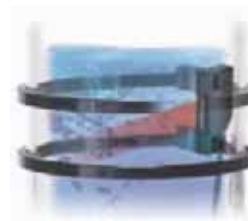

For liquid surface level upper limit sensing, a "without fluid" incident light sensor is recommended.

The sensor will turn OFF during abnormal conditions (excess fluid, fiber disconnection, etc.)!

Liquid absent: Beam received (Output ON)

Liquid present / fiber is cutoff: Beam not received (Output OFF)

FD-FA93

Strong against air bubbles

Applicable pipe: Transparent pipe, Outer diameter $\phi 8$ mm

$\phi 0.315$ in or more

(When used with the tying bands: $\phi 8$ to $\phi 80$ mm $\phi 0.315$ to $\phi 3.150$ in)

FD-F41

Standard type

FD-F4

For 1 mm 0.039 in thick pipes manufactured by PFA



We recommend using the sensor so that the output is ON when liquid is present at lower limit detection level.

The sensor will turn OFF during abnormal conditions (insufficient liquid, fiber disconnection, etc.)!

Liquid present: Beam received (Output ON)

Liquid absent / fiber is cutoff: Beam not received (Output OFF)

FT-F93

Thru-beam



Reflective type / Thru-beam type

Type	Shape of fiber head (mm)	Model No.	Bending radius (mm)	Fiber cable length Free-cut	Description		Protection	Ambient temp.
					FX-500 series (STD mode)	FX-101 FX-102		
Contact type	Liquid level sensing	Heat resistant 125 °C Fluorine resin coating $\phi 6$	FD-F8Y	Protective tube R40 Fiber R15	2 m (Note 1)	$\phi 6$ mm $\phi 0.236$ in Protective tube: Fluorine resin, length 1,000 mm 39.370 in (not cuttable) Liquid surface not contacted: Beam received, Liquid surface contacted: Beam not received	IP68	-40 to +125 °C
		Heat resistant 105 °C Fluorine resin coating $\phi 4$	FD-HF40Y (Note 2)	Protective tube R20 Fiber	2 m	$\phi 4$ mm $\phi 0.157$ in Protective tube: Fluorine resin, length 500 mm 19.685 in (cuttable) Liquid surface not contacted: Beam received, Liquid surface contacted: Beam not received	IP67	-40 to +105 °C
		Heat resistant 70 °C Fluorine resin coating throughout the fiber $\phi 4$	FD-F41Y (Note 2)	R10	2 m	$\phi 4$ mm $\phi 0.157$ in Protective tube: Fluorine resin, length 500 mm 19.685 in (cuttable) Liquid surface not contacted: Beam received, Liquid surface contacted: Beam not received		
Pipe-mountable type	Liquid leak detection	SEMI S2 compliant W20 × H30 × D10	Tough NEW FD-F71	Protective tube R20 Fiber R4	5 m	Liquid leak detection Leak absent: Beam received, Leak present: Beam interrupted		-20 to +60 °C
		Standard W25 × H13 × D20	FD-F41	R10	2 m	Applicable pipe diameter: Outer dia. $\phi 6$ to $\phi 26$ mm $\phi 0.236$ to $\phi 1.024$ in transparent pipe [PVC (vinyl chloride), fluorine resin, polycarbonate, acrylic, glass, wall thickness 1 to 3 mm 0.039 to 0.118 in] Liquid absent: Beam received, Liquid present: Beam not received	-	-40 to +100 °C
	For 1 mm thick PFA pipe W25 × H13 × D20	FD-F4	Applicable pipe diameter: Outer dia. $\phi 6$ to $\phi 26$ mm $\phi 0.236$ to $\phi 1.024$ in transparent pipe [PFA (fluorine resin) or equivalently transparent pipe, wall thickness 1 mm 0.039 in] Liquid absent: Beam received, Liquid present: Beam not received					
	Liquid sensing	Mountable on pipe-array fiber W6.5 × H28.3 × D17	Tough NEW FD-FA93	R4	2 m	Applicable pipe diameter: Outer dia. $\phi 8$ mm $\phi 0.315$ in or more transparent pipe (When used with the tying bands: $\phi 8$ to $\phi 80$ mm $\phi 0.315$ to $\phi 3.150$ in) [PFA (fluorine resin), including translucent] Liquid absent: Beam received, Liquid present: Beam not received	IP40	-40 to +70 °C
		SEMI S2 compliant W23 × H20 × D17	Tough NEW FT-F93	Protective tube R20 Fiber R2		Applicable pipe diameter: Outer dia. $\phi 3$ to $\phi 10$ mm $\phi 0.118$ to $\phi 0.394$ in transparent pipe [PFA (fluorine resin) or equivalently transparent pipe, wall thickness 0.3 to 1 mm 0.012 to 0.039 in] Liquid absent: Beam not received, Liquid present: Beam received		

Notes: 1) The allowable cutting range is 1,000 mm 39.370 in from the end that the amplifier inserted.

2) Liquid inflow prevention joint, protective tube extension joint, fiber mounting joint is available. Please refer to next page for details.

Tough : It is a fiber which possesses both unbreakable (bending radius: R10 mm, reciprocating bending: 180°) and bendable (bending radius: R4 mm or less) features.

New product introduction
Tough Fiber
 Fiber Selection Guide
 Choose by model
 Choose by shape/application
 Viewing new models

Accessories

• **MS-FD-F7-1**
 (SUS mounting bracket for **FD-F71**)

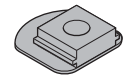

• **MS-FD-F7-2**
 (PVC mounting bracket for **FD-F71**)

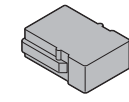

Fiber options

Designation	Model No.	Description	
Liquid inflow prevention joint (Note)	MS-FX-01Y	Applicable fibers FD-HF40Y FD-F41Y	This joint suppresses false operations due to liquid slip-in from the top of the protective tube.
Protective tube extension joint (Note)	MS-FX-02Y		The protective tube can be extended.
Fiber mounting joint (Note)	MS-FX-03Y		The joint is used for mounting fibers on a tank.

Note: The joint internal ferrule (**MS-FX-YF**) is available as a spare part. A distorted ferrule may result in leakage.

Liquid inflow prevention joint

• **MS-FX-01Y**

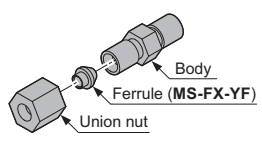

Protective tube extension joint

• **MS-FX-02Y**

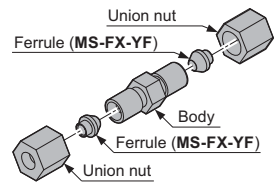

Fiber mounting joint

• **MS-FX-03Y**

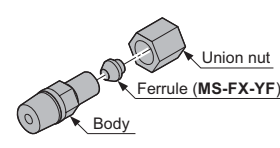

Fibers
 Super Quality
 Threaded Type
 Cylindrical Type
 Sleeve
 Flat Type
 Small Spot
 Narrow Beam
 Wide Beam
 Convergent Reflective Type
 Retroreflective Type
 Chemical-resistant
 Heat-resistant
 Vacuum-resistant
 Liquid Leak / Liquid Detection

Fiber Options

Fiber Dimensions
 Thru-beam Type
 Retroreflective Type
 Reflective Type
 Others

Amplifiers
 FX-500 series
 FX-100 series

INDEX

Earlier models comparison table

Fiber options

New product introduction

Tough Fiber

Fiber Selection Guide

Choose by model

Choose by shape/application

Viewing new models

Fibers

Super Quality

Threaded Type

Cylindrical Type

Sleeve

Flat Type

Small Spot

Narrow Beam

Wide Beam

Convergent Reflective Type

Retroreflective Type

Chemical-resistant

Heat-resistant

Vacuum-resistant

Liquid Leak / Liquid Detection

Fiber Options

Fiber Dimensions

Thru-beam Type

Retroreflective Type

Reflective Type

Others

Amplifiers

FX-500 series

FX-100 series

INDEX

Earlier models comparison table

Lens (For thru-beam type fiber)

Designation	Model No.	Description																																																																																																																																							
For thru-beam type fiber	Expansion lens (Note 1) FX-LE1	<p>Increases the sensing range by 5 times or more.</p> <ul style="list-style-type: none"> • Ambient temperature: -60 to +350 °C -76 to +662 °F (Note 3) • Beam dia: ø3.6 mm ø0.142 in <p>Sensing range (mm in) [Lens on both sides]</p> <table border="1"> <thead> <tr> <th rowspan="2">Amplifier Fiber \ Mode</th> <th colspan="6">FX-500 series</th> <th rowspan="2">FX-101 □</th> <th rowspan="2">FX-102 □</th> </tr> <tr> <th>HYPR</th> <th>U-LG</th> <th>LONG</th> <th>STD</th> <th>FAST</th> <th>H-SP</th> </tr> </thead> <tbody> <tr> <td rowspan="2">FT-43</td> <td>3,600 141.732 (Note 2)</td> <td>3,600 141.732 (Note 2)</td> <td>3,600 141.732 (Note 2)</td> <td>3,600 141.732 (Note 2)</td> <td>3,600 141.732 (Note 2)</td> <td>3,600 141.732 (Note 2)</td> <td rowspan="2">2,400 94.488</td> <td rowspan="2">3,600 141.732 (Note 2)</td> </tr> <tr> <td>1,600 62.992 (Note 2)</td> <td>1,600 62.992 (Note 2)</td> <td>1,600 62.992 (Note 2)</td> <td>1,600 62.992 (Note 2)</td> <td>1,600 62.992 (Note 2)</td> <td>1,600 62.992 (Note 2)</td> </tr> <tr> <td rowspan="2">FT-42 FT-42W</td> <td>3,600 141.732 (Note 2)</td> <td>3,600 141.732 (Note 2)</td> <td>3,600 141.732 (Note 2)</td> <td>3,600 141.732 (Note 2)</td> <td>3,600 141.732 (Note 2)</td> <td>3,600 141.732 (Note 2)</td> <td rowspan="2">2,200 86.614</td> <td rowspan="2">3,400 133.858</td> </tr> <tr> <td>1,600 62.992 (Note 2)</td> <td>1,600 62.992 (Note 2)</td> <td>1,600 62.992 (Note 2)</td> <td>1,600 62.992 (Note 2)</td> <td>1,600 62.992 (Note 2)</td> <td>1,600 62.992 (Note 2)</td> </tr> <tr> <td rowspan="2">FT-45X</td> <td>3,600 141.732 (Note 2)</td> <td>3,600 141.732 (Note 2)</td> <td>3,600 141.732 (Note 2)</td> <td>3,600 141.732 (Note 2)</td> <td>3,600 141.732 (Note 2)</td> <td>3,600 141.732 (Note 2)</td> <td rowspan="2">1,900 74.803</td> <td rowspan="2">3,100 122.047</td> </tr> <tr> <td>1,600 62.992 (Note 2)</td> <td>1,600 62.992 (Note 2)</td> <td>1,600 62.992 (Note 2)</td> <td>1,600 62.992 (Note 2)</td> <td>1,600 62.992 (Note 2)</td> <td>1,600 62.992 (Note 2)</td> </tr> <tr> <td rowspan="2">FT-R40</td> <td>3,600 141.732 (Note 2)</td> <td>3,600 141.732 (Note 2)</td> <td>3,600 141.732 (Note 2)</td> <td>3,600 141.732 (Note 2)</td> <td>3,600 141.732 (Note 2)</td> <td>3,600 141.732 (Note 2)</td> <td rowspan="2">1,900 74.803</td> <td rowspan="2">3,100 122.047</td> </tr> <tr> <td>1,600 62.992 (Note 2)</td> <td>1,600 62.992 (Note 2)</td> <td>1,600 62.992 (Note 2)</td> <td>1,600 62.992 (Note 2)</td> <td>1,600 62.992 (Note 2)</td> <td>1,600 62.992 (Note 2)</td> </tr> <tr> <td rowspan="2">FT-H35-M2</td> <td>3,600 141.732 (Note 2)</td> <td>3,600 141.732 (Note 2)</td> <td>3,600 141.732 (Note 2)</td> <td>3,600 141.732 (Note 2)</td> <td>3,300 129.921</td> <td>3,600 141.732 (Note 2)</td> <td rowspan="2">1,400 55.118</td> <td rowspan="2">2,000 78.740</td> </tr> <tr> <td>1,600 62.992 (Note 2)</td> <td>1,600 62.992 (Note 2)</td> <td>1,600 62.992 (Note 2)</td> <td>1,600 62.992 (Note 2)</td> <td>1,600 62.992 (Note 2)</td> <td>1,600 62.992 (Note 2)</td> </tr> <tr> <td rowspan="2">FT-H20W-M1</td> <td>1,600 62.992 (Note 2)</td> <td>1,600 62.992 (Note 2)</td> <td>1,600 62.992 (Note 2)</td> <td>1,600 62.992 (Note 2)</td> <td>1,600 62.992 (Note 2)</td> <td>1,600 62.992 (Note 2)</td> <td rowspan="2">850 33.465</td> <td rowspan="2">1,300 51.181</td> </tr> <tr> <td>3,600 141.732 (Note 2)</td> <td>3,600 141.732 (Note 2)</td> <td>3,500 137.795</td> <td>2,000 78.740</td> <td>1,600 62.992 (Note 2)</td> <td>500 19.685</td> </tr> <tr> <td rowspan="2">FT-H20-M1</td> <td>1,600 62.992 (Note 2)</td> <td>1,600 62.992 (Note 2)</td> <td>1,600 62.992 (Note 2)</td> <td>1,600 62.992 (Note 2)</td> <td>1,600 62.992 (Note 2)</td> <td>1,600 62.992 (Note 2)</td> <td rowspan="2">1,200 47.244</td> <td rowspan="2">1,600 62.992 (Note 2)</td> </tr> <tr> <td>3,600 141.732 (Note 2)</td> <td>3,600 141.732 (Note 2)</td> <td>3,500 137.795</td> <td>2,000 78.740</td> <td>1,600 62.992 (Note 2)</td> <td>500 19.685</td> </tr> <tr> <td rowspan="2">FT-H20-J50-S FT-H20-J30-S FT-H20-J20-S</td> <td>3,600 141.732 (Note 2)</td> <td>3,600 141.732 (Note 2)</td> <td>3,500 137.795</td> <td>2,000 78.740</td> <td>1,600 62.992 (Note 2)</td> <td>500 19.685</td> <td rowspan="2">1,000 39.370</td> <td rowspan="2">3,500 137.795 (Note 2)</td> </tr> <tr> <td>1,600 62.992 (Note 2)</td> <td>1,600 62.992 (Note 2)</td> <td>1,600 62.992 (Note 2)</td> <td>1,600 62.992 (Note 2)</td> <td>1,600 62.992 (Note 2)</td> <td>1,600 62.992 (Note 2)</td> </tr> </tbody> </table>	Amplifier Fiber \ Mode	FX-500 series						FX-101 □	FX-102 □	HYPR	U-LG	LONG	STD	FAST	H-SP	FT-43	3,600 141.732 (Note 2)	3,600 141.732 (Note 2)	3,600 141.732 (Note 2)	3,600 141.732 (Note 2)	3,600 141.732 (Note 2)	3,600 141.732 (Note 2)	2,400 94.488	3,600 141.732 (Note 2)	1,600 62.992 (Note 2)	1,600 62.992 (Note 2)	1,600 62.992 (Note 2)	1,600 62.992 (Note 2)	1,600 62.992 (Note 2)	1,600 62.992 (Note 2)	FT-42 FT-42W	3,600 141.732 (Note 2)	3,600 141.732 (Note 2)	3,600 141.732 (Note 2)	3,600 141.732 (Note 2)	3,600 141.732 (Note 2)	3,600 141.732 (Note 2)	2,200 86.614	3,400 133.858	1,600 62.992 (Note 2)	1,600 62.992 (Note 2)	1,600 62.992 (Note 2)	1,600 62.992 (Note 2)	1,600 62.992 (Note 2)	1,600 62.992 (Note 2)	FT-45X	3,600 141.732 (Note 2)	3,600 141.732 (Note 2)	3,600 141.732 (Note 2)	3,600 141.732 (Note 2)	3,600 141.732 (Note 2)	3,600 141.732 (Note 2)	1,900 74.803	3,100 122.047	1,600 62.992 (Note 2)	1,600 62.992 (Note 2)	1,600 62.992 (Note 2)	1,600 62.992 (Note 2)	1,600 62.992 (Note 2)	1,600 62.992 (Note 2)	FT-R40	3,600 141.732 (Note 2)	3,600 141.732 (Note 2)	3,600 141.732 (Note 2)	3,600 141.732 (Note 2)	3,600 141.732 (Note 2)	3,600 141.732 (Note 2)	1,900 74.803	3,100 122.047	1,600 62.992 (Note 2)	1,600 62.992 (Note 2)	1,600 62.992 (Note 2)	1,600 62.992 (Note 2)	1,600 62.992 (Note 2)	1,600 62.992 (Note 2)	FT-H35-M2	3,600 141.732 (Note 2)	3,600 141.732 (Note 2)	3,600 141.732 (Note 2)	3,600 141.732 (Note 2)	3,300 129.921	3,600 141.732 (Note 2)	1,400 55.118	2,000 78.740	1,600 62.992 (Note 2)	1,600 62.992 (Note 2)	1,600 62.992 (Note 2)	1,600 62.992 (Note 2)	1,600 62.992 (Note 2)	1,600 62.992 (Note 2)	FT-H20W-M1	1,600 62.992 (Note 2)	1,600 62.992 (Note 2)	1,600 62.992 (Note 2)	1,600 62.992 (Note 2)	1,600 62.992 (Note 2)	1,600 62.992 (Note 2)	850 33.465	1,300 51.181	3,600 141.732 (Note 2)	3,600 141.732 (Note 2)	3,500 137.795	2,000 78.740	1,600 62.992 (Note 2)	500 19.685	FT-H20-M1	1,600 62.992 (Note 2)	1,600 62.992 (Note 2)	1,600 62.992 (Note 2)	1,600 62.992 (Note 2)	1,600 62.992 (Note 2)	1,600 62.992 (Note 2)	1,200 47.244	1,600 62.992 (Note 2)	3,600 141.732 (Note 2)	3,600 141.732 (Note 2)	3,500 137.795	2,000 78.740	1,600 62.992 (Note 2)	500 19.685	FT-H20-J50-S FT-H20-J30-S FT-H20-J20-S	3,600 141.732 (Note 2)	3,600 141.732 (Note 2)	3,500 137.795	2,000 78.740	1,600 62.992 (Note 2)	500 19.685	1,000 39.370	3,500 137.795 (Note 2)	1,600 62.992 (Note 2)	1,600 62.992 (Note 2)	1,600 62.992 (Note 2)	1,600 62.992 (Note 2)	1,600 62.992 (Note 2)	1,600 62.992 (Note 2)
		Amplifier Fiber \ Mode		FX-500 series								FX-101 □	FX-102 □																																																																																																																												
			HYPR	U-LG	LONG	STD	FAST	H-SP																																																																																																																																	
		FT-43	3,600 141.732 (Note 2)	3,600 141.732 (Note 2)	3,600 141.732 (Note 2)	3,600 141.732 (Note 2)	3,600 141.732 (Note 2)	3,600 141.732 (Note 2)	2,400 94.488	3,600 141.732 (Note 2)																																																																																																																															
			1,600 62.992 (Note 2)	1,600 62.992 (Note 2)	1,600 62.992 (Note 2)	1,600 62.992 (Note 2)	1,600 62.992 (Note 2)	1,600 62.992 (Note 2)																																																																																																																																	
		FT-42 FT-42W	3,600 141.732 (Note 2)	3,600 141.732 (Note 2)	3,600 141.732 (Note 2)	3,600 141.732 (Note 2)	3,600 141.732 (Note 2)	3,600 141.732 (Note 2)	2,200 86.614	3,400 133.858																																																																																																																															
			1,600 62.992 (Note 2)	1,600 62.992 (Note 2)	1,600 62.992 (Note 2)	1,600 62.992 (Note 2)	1,600 62.992 (Note 2)	1,600 62.992 (Note 2)																																																																																																																																	
		FT-45X	3,600 141.732 (Note 2)	3,600 141.732 (Note 2)	3,600 141.732 (Note 2)	3,600 141.732 (Note 2)	3,600 141.732 (Note 2)	3,600 141.732 (Note 2)	1,900 74.803	3,100 122.047																																																																																																																															
			1,600 62.992 (Note 2)	1,600 62.992 (Note 2)	1,600 62.992 (Note 2)	1,600 62.992 (Note 2)	1,600 62.992 (Note 2)	1,600 62.992 (Note 2)																																																																																																																																	
		FT-R40	3,600 141.732 (Note 2)	3,600 141.732 (Note 2)	3,600 141.732 (Note 2)	3,600 141.732 (Note 2)	3,600 141.732 (Note 2)	3,600 141.732 (Note 2)	1,900 74.803	3,100 122.047																																																																																																																															
1,600 62.992 (Note 2)	1,600 62.992 (Note 2)		1,600 62.992 (Note 2)	1,600 62.992 (Note 2)	1,600 62.992 (Note 2)	1,600 62.992 (Note 2)																																																																																																																																			
FT-H35-M2	3,600 141.732 (Note 2)	3,600 141.732 (Note 2)	3,600 141.732 (Note 2)	3,600 141.732 (Note 2)	3,300 129.921	3,600 141.732 (Note 2)	1,400 55.118	2,000 78.740																																																																																																																																	
	1,600 62.992 (Note 2)	1,600 62.992 (Note 2)	1,600 62.992 (Note 2)	1,600 62.992 (Note 2)	1,600 62.992 (Note 2)	1,600 62.992 (Note 2)																																																																																																																																			
FT-H20W-M1	1,600 62.992 (Note 2)	1,600 62.992 (Note 2)	1,600 62.992 (Note 2)	1,600 62.992 (Note 2)	1,600 62.992 (Note 2)	1,600 62.992 (Note 2)	850 33.465	1,300 51.181																																																																																																																																	
	3,600 141.732 (Note 2)	3,600 141.732 (Note 2)	3,500 137.795	2,000 78.740	1,600 62.992 (Note 2)	500 19.685																																																																																																																																			
FT-H20-M1	1,600 62.992 (Note 2)	1,600 62.992 (Note 2)	1,600 62.992 (Note 2)	1,600 62.992 (Note 2)	1,600 62.992 (Note 2)	1,600 62.992 (Note 2)	1,200 47.244	1,600 62.992 (Note 2)																																																																																																																																	
	3,600 141.732 (Note 2)	3,600 141.732 (Note 2)	3,500 137.795	2,000 78.740	1,600 62.992 (Note 2)	500 19.685																																																																																																																																			
FT-H20-J50-S FT-H20-J30-S FT-H20-J20-S	3,600 141.732 (Note 2)	3,600 141.732 (Note 2)	3,500 137.795	2,000 78.740	1,600 62.992 (Note 2)	500 19.685	1,000 39.370	3,500 137.795 (Note 2)																																																																																																																																	
	1,600 62.992 (Note 2)	1,600 62.992 (Note 2)	1,600 62.992 (Note 2)	1,600 62.992 (Note 2)	1,600 62.992 (Note 2)	1,600 62.992 (Note 2)																																																																																																																																			
For thru-beam type fiber	Super-expansion lens (Note 1) FX-LE2	<p>Tremendously increases the sensing range with large diameter lenses.</p> <ul style="list-style-type: none"> • Ambient temperature: -60 to +350 °C -76 to +662 °F (Note 3) • Beam dia: ø9.8 mm ø0.386 in <p>Sensing range (mm in) [Lens on both sides]</p> <table border="1"> <thead> <tr> <th rowspan="2">Amplifier Fiber \ Mode</th> <th colspan="6">FX-500 series</th> <th rowspan="2">FX-101 □</th> <th rowspan="2">FX-102 □</th> </tr> <tr> <th>HYPR</th> <th>U-LG</th> <th>LONG</th> <th>STD</th> <th>FAST</th> <th>H-SP</th> </tr> </thead> <tbody> <tr> <td rowspan="2">FT-43 FT-42 FT-42W</td> <td>3,600 141.732 (Note 2)</td> <td>3,600 141.732 (Note 2)</td> <td>3,600 141.732 (Note 2)</td> <td>3,600 141.732 (Note 2)</td> <td>3,600 141.732 (Note 2)</td> <td>3,600 141.732 (Note 2)</td> <td rowspan="2">3,600 141.732 (Note 2)</td> <td rowspan="2">3,600 141.732 (Note 2)</td> </tr> <tr> <td>1,600 62.992 (Note 2)</td> <td>1,600 62.992 (Note 2)</td> <td>1,600 62.992 (Note 2)</td> <td>1,600 62.992 (Note 2)</td> <td>1,600 62.992 (Note 2)</td> <td>1,600 62.992 (Note 2)</td> </tr> <tr> <td rowspan="2">FT-45X</td> <td>3,600 141.732 (Note 2)</td> <td>3,600 141.732 (Note 2)</td> <td>3,600 141.732 (Note 2)</td> <td>3,600 141.732 (Note 2)</td> <td>3,600 141.732 (Note 2)</td> <td>3,600 141.732 (Note 2)</td> <td rowspan="2">3,600 141.732 (Note 2)</td> <td rowspan="2">3,600 141.732 (Note 2)</td> </tr> <tr> <td>1,600 62.992 (Note 2)</td> <td>1,600 62.992 (Note 2)</td> <td>1,600 62.992 (Note 2)</td> <td>1,600 62.992 (Note 2)</td> <td>1,600 62.992 (Note 2)</td> <td>1,600 62.992 (Note 2)</td> </tr> <tr> <td rowspan="2">FT-R40</td> <td>3,600 141.732 (Note 2)</td> <td>3,600 141.732 (Note 2)</td> <td>3,600 141.732 (Note 2)</td> <td>3,600 141.732 (Note 2)</td> <td>3,600 141.732 (Note 2)</td> <td>3,600 141.732 (Note 2)</td> <td rowspan="2">3,600 141.732 (Note 2)</td> <td rowspan="2">3,600 141.732 (Note 2)</td> </tr> <tr> <td>1,600 62.992 (Note 2)</td> <td>1,600 62.992 (Note 2)</td> <td>1,600 62.992 (Note 2)</td> <td>1,600 62.992 (Note 2)</td> <td>1,600 62.992 (Note 2)</td> <td>1,600 62.992 (Note 2)</td> </tr> <tr> <td rowspan="2">FT-H35-M2</td> <td>3,600 141.732 (Note 2)</td> <td>3,600 141.732 (Note 2)</td> <td>3,600 141.732 (Note 2)</td> <td>3,600 141.732 (Note 2)</td> <td>3,600 141.732 (Note 2)</td> <td>3,600 141.732 (Note 2)</td> <td rowspan="2">3,500 137.795 (Note 2)</td> <td rowspan="2">3,500 137.795 (Note 2)</td> </tr> <tr> <td>1,600 62.992 (Note 2)</td> <td>1,600 62.992 (Note 2)</td> <td>1,600 62.992 (Note 2)</td> <td>1,600 62.992 (Note 2)</td> <td>1,600 62.992 (Note 2)</td> <td>1,600 62.992 (Note 2)</td> </tr> <tr> <td rowspan="2">FT-H20W-M1 FT-H20-M1</td> <td>3,600 141.732 (Note 2)</td> <td>3,600 141.732 (Note 2)</td> <td>3,600 141.732 (Note 2)</td> <td>3,600 141.732 (Note 2)</td> <td>3,600 141.732 (Note 2)</td> <td>3,600 141.732 (Note 2)</td> <td rowspan="2">3,500 137.795 (Note 2)</td> <td rowspan="2">3,500 137.795 (Note 2)</td> </tr> <tr> <td>1,600 62.992 (Note 2)</td> <td>1,600 62.992 (Note 2)</td> <td>1,600 62.992 (Note 2)</td> <td>1,600 62.992 (Note 2)</td> <td>1,600 62.992 (Note 2)</td> <td>1,600 62.992 (Note 2)</td> </tr> <tr> <td rowspan="2">FT-H13-FM2</td> <td>3,600 141.732 (Note 2)</td> <td>3,600 141.732 (Note 2)</td> <td>3,600 141.732 (Note 2)</td> <td>3,600 141.732 (Note 2)</td> <td>3,600 141.732 (Note 2)</td> <td>3,600 141.732 (Note 2)</td> <td rowspan="2">3,500 137.795 (Note 2)</td> <td rowspan="2">3,500 137.795 (Note 2)</td> </tr> <tr> <td>1,600 62.992 (Note 2)</td> <td>1,600 62.992 (Note 2)</td> <td>1,600 62.992 (Note 2)</td> <td>1,600 62.992 (Note 2)</td> <td>1,600 62.992 (Note 2)</td> <td>1,600 62.992 (Note 2)</td> </tr> <tr> <td rowspan="2">FT-H20-J50-S FT-H20-J30-S FT-H20-J20-S</td> <td>3,600 141.732 (Note 2)</td> <td>3,600 141.732 (Note 2)</td> <td>3,600 141.732 (Note 2)</td> <td>3,600 141.732 (Note 2)</td> <td>3,600 141.732 (Note 2)</td> <td>3,600 141.732 (Note 2)</td> <td rowspan="2">3,500 137.795 (Note 2)</td> <td rowspan="2">3,500 137.795 (Note 2)</td> </tr> <tr> <td>1,600 62.992 (Note 2)</td> <td>1,600 62.992 (Note 2)</td> <td>1,600 62.992 (Note 2)</td> <td>1,600 62.992 (Note 2)</td> <td>1,600 62.992 (Note 2)</td> <td>1,600 62.992 (Note 2)</td> </tr> </tbody> </table>	Amplifier Fiber \ Mode	FX-500 series						FX-101 □	FX-102 □	HYPR	U-LG	LONG	STD	FAST	H-SP	FT-43 FT-42 FT-42W	3,600 141.732 (Note 2)	3,600 141.732 (Note 2)	3,600 141.732 (Note 2)	3,600 141.732 (Note 2)	3,600 141.732 (Note 2)	3,600 141.732 (Note 2)	3,600 141.732 (Note 2)	3,600 141.732 (Note 2)	1,600 62.992 (Note 2)	1,600 62.992 (Note 2)	1,600 62.992 (Note 2)	1,600 62.992 (Note 2)	1,600 62.992 (Note 2)	1,600 62.992 (Note 2)	FT-45X	3,600 141.732 (Note 2)	3,600 141.732 (Note 2)	3,600 141.732 (Note 2)	3,600 141.732 (Note 2)	3,600 141.732 (Note 2)	3,600 141.732 (Note 2)	3,600 141.732 (Note 2)	3,600 141.732 (Note 2)	1,600 62.992 (Note 2)	1,600 62.992 (Note 2)	1,600 62.992 (Note 2)	1,600 62.992 (Note 2)	1,600 62.992 (Note 2)	1,600 62.992 (Note 2)	FT-R40	3,600 141.732 (Note 2)	3,600 141.732 (Note 2)	3,600 141.732 (Note 2)	3,600 141.732 (Note 2)	3,600 141.732 (Note 2)	3,600 141.732 (Note 2)	3,600 141.732 (Note 2)	3,600 141.732 (Note 2)	1,600 62.992 (Note 2)	1,600 62.992 (Note 2)	1,600 62.992 (Note 2)	1,600 62.992 (Note 2)	1,600 62.992 (Note 2)	1,600 62.992 (Note 2)	FT-H35-M2	3,600 141.732 (Note 2)	3,600 141.732 (Note 2)	3,600 141.732 (Note 2)	3,600 141.732 (Note 2)	3,600 141.732 (Note 2)	3,600 141.732 (Note 2)	3,500 137.795 (Note 2)	3,500 137.795 (Note 2)	1,600 62.992 (Note 2)	1,600 62.992 (Note 2)	1,600 62.992 (Note 2)	1,600 62.992 (Note 2)	1,600 62.992 (Note 2)	1,600 62.992 (Note 2)	FT-H20W-M1 FT-H20-M1	3,600 141.732 (Note 2)	3,600 141.732 (Note 2)	3,600 141.732 (Note 2)	3,600 141.732 (Note 2)	3,600 141.732 (Note 2)	3,600 141.732 (Note 2)	3,500 137.795 (Note 2)	3,500 137.795 (Note 2)	1,600 62.992 (Note 2)	1,600 62.992 (Note 2)	1,600 62.992 (Note 2)	1,600 62.992 (Note 2)	1,600 62.992 (Note 2)	1,600 62.992 (Note 2)	FT-H13-FM2	3,600 141.732 (Note 2)	3,600 141.732 (Note 2)	3,600 141.732 (Note 2)	3,600 141.732 (Note 2)	3,600 141.732 (Note 2)	3,600 141.732 (Note 2)	3,500 137.795 (Note 2)	3,500 137.795 (Note 2)	1,600 62.992 (Note 2)	1,600 62.992 (Note 2)	1,600 62.992 (Note 2)	1,600 62.992 (Note 2)	1,600 62.992 (Note 2)	1,600 62.992 (Note 2)	FT-H20-J50-S FT-H20-J30-S FT-H20-J20-S	3,600 141.732 (Note 2)	3,600 141.732 (Note 2)	3,600 141.732 (Note 2)	3,600 141.732 (Note 2)	3,600 141.732 (Note 2)	3,600 141.732 (Note 2)	3,500 137.795 (Note 2)	3,500 137.795 (Note 2)	1,600 62.992 (Note 2)	1,600 62.992 (Note 2)	1,600 62.992 (Note 2)	1,600 62.992 (Note 2)	1,600 62.992 (Note 2)	1,600 62.992 (Note 2)															
		Amplifier Fiber \ Mode		FX-500 series								FX-101 □	FX-102 □																																																																																																																												
			HYPR	U-LG	LONG	STD	FAST	H-SP																																																																																																																																	
		FT-43 FT-42 FT-42W	3,600 141.732 (Note 2)	3,600 141.732 (Note 2)	3,600 141.732 (Note 2)	3,600 141.732 (Note 2)	3,600 141.732 (Note 2)	3,600 141.732 (Note 2)	3,600 141.732 (Note 2)	3,600 141.732 (Note 2)																																																																																																																															
			1,600 62.992 (Note 2)	1,600 62.992 (Note 2)	1,600 62.992 (Note 2)	1,600 62.992 (Note 2)	1,600 62.992 (Note 2)	1,600 62.992 (Note 2)																																																																																																																																	
		FT-45X	3,600 141.732 (Note 2)	3,600 141.732 (Note 2)	3,600 141.732 (Note 2)	3,600 141.732 (Note 2)	3,600 141.732 (Note 2)	3,600 141.732 (Note 2)	3,600 141.732 (Note 2)	3,600 141.732 (Note 2)																																																																																																																															
			1,600 62.992 (Note 2)	1,600 62.992 (Note 2)	1,600 62.992 (Note 2)	1,600 62.992 (Note 2)	1,600 62.992 (Note 2)	1,600 62.992 (Note 2)																																																																																																																																	
		FT-R40	3,600 141.732 (Note 2)	3,600 141.732 (Note 2)	3,600 141.732 (Note 2)	3,600 141.732 (Note 2)	3,600 141.732 (Note 2)	3,600 141.732 (Note 2)	3,600 141.732 (Note 2)	3,600 141.732 (Note 2)																																																																																																																															
			1,600 62.992 (Note 2)	1,600 62.992 (Note 2)	1,600 62.992 (Note 2)	1,600 62.992 (Note 2)	1,600 62.992 (Note 2)	1,600 62.992 (Note 2)																																																																																																																																	
		FT-H35-M2	3,600 141.732 (Note 2)	3,600 141.732 (Note 2)	3,600 141.732 (Note 2)	3,600 141.732 (Note 2)	3,600 141.732 (Note 2)	3,600 141.732 (Note 2)	3,500 137.795 (Note 2)	3,500 137.795 (Note 2)																																																																																																																															
1,600 62.992 (Note 2)	1,600 62.992 (Note 2)		1,600 62.992 (Note 2)	1,600 62.992 (Note 2)	1,600 62.992 (Note 2)	1,600 62.992 (Note 2)																																																																																																																																			
FT-H20W-M1 FT-H20-M1	3,600 141.732 (Note 2)	3,600 141.732 (Note 2)	3,600 141.732 (Note 2)	3,600 141.732 (Note 2)	3,600 141.732 (Note 2)	3,600 141.732 (Note 2)	3,500 137.795 (Note 2)	3,500 137.795 (Note 2)																																																																																																																																	
	1,600 62.992 (Note 2)	1,600 62.992 (Note 2)	1,600 62.992 (Note 2)	1,600 62.992 (Note 2)	1,600 62.992 (Note 2)	1,600 62.992 (Note 2)																																																																																																																																			
FT-H13-FM2	3,600 141.732 (Note 2)	3,600 141.732 (Note 2)	3,600 141.732 (Note 2)	3,600 141.732 (Note 2)	3,600 141.732 (Note 2)	3,600 141.732 (Note 2)	3,500 137.795 (Note 2)	3,500 137.795 (Note 2)																																																																																																																																	
	1,600 62.992 (Note 2)	1,600 62.992 (Note 2)	1,600 62.992 (Note 2)	1,600 62.992 (Note 2)	1,600 62.992 (Note 2)	1,600 62.992 (Note 2)																																																																																																																																			
FT-H20-J50-S FT-H20-J30-S FT-H20-J20-S	3,600 141.732 (Note 2)	3,600 141.732 (Note 2)	3,600 141.732 (Note 2)	3,600 141.732 (Note 2)	3,600 141.732 (Note 2)	3,600 141.732 (Note 2)	3,500 137.795 (Note 2)	3,500 137.795 (Note 2)																																																																																																																																	
	1,600 62.992 (Note 2)	1,600 62.992 (Note 2)	1,600 62.992 (Note 2)	1,600 62.992 (Note 2)	1,600 62.992 (Note 2)	1,600 62.992 (Note 2)																																																																																																																																			

Notes: 1) Be careful sure to use it only after you have adjusted it sufficiently when installing the thru-beam type fiber equipped with the expansion lens, as the beam envelope becomes narrow and alignment is difficult.
 2) The fiber cable length practically limits the sensing range.
 3) Refer to P.10~ for the ambient temperature of fibers to be used in combination.

Fiber options

Lens (For thru-beam type fiber)

Designation	Model No.	Description																																																																																																																																																																																			
For thru-beam type fiber	Side-view lens FX-SV1	<p>Beam axis is bent by 90°.</p> <ul style="list-style-type: none"> Ambient temperature: -60 to +300 °C -76 to +572 °F (Note 4) Beam dia: \varnothing2.8 mm \varnothing0.110 in <p>Sensing range (mm in) [Lens on both sides]</p> <table border="1"> <thead> <tr> <th rowspan="2">Fiber</th> <th colspan="2">Amplifier</th> <th colspan="5">FX-500 series</th> <th rowspan="2">FX-101□</th> <th rowspan="2">FX-102□</th> </tr> <tr> <th>Mode</th> <th></th> <th>HYPR</th> <th>U-LG</th> <th>LONG</th> <th>STD</th> <th>FAST</th> <th>H-SP</th> </tr> </thead> <tbody> <tr> <td rowspan="2">FT-43</td> <td>3,600</td> <td></td> <td>3,400</td> <td>2,600</td> <td>1,700</td> <td>970</td> <td>310</td> <td>510</td> <td>1,400</td> </tr> <tr> <td>141.732 (Note 2)</td> <td></td> <td>133.858</td> <td>102.362</td> <td>66.929</td> <td>38.189</td> <td>12.205</td> <td>20.079</td> <td>55.118</td> </tr> <tr> <td rowspan="2">FT-42</td> <td>3,600</td> <td></td> <td>3,600</td> <td>3,600</td> <td>2,100</td> <td>1,150</td> <td>370</td> <td>500</td> <td>1,700</td> </tr> <tr> <td>141.732 (Note 2)</td> <td></td> <td>141.732 (Note 2)</td> <td>141.732 (Note 2)</td> <td>82.677</td> <td>45.276</td> <td>14.567</td> <td>19.685</td> <td>66.929</td> </tr> <tr> <td rowspan="2">FT-42W</td> <td>3,600</td> <td></td> <td>3,500</td> <td>2,700</td> <td>1,800</td> <td>990</td> <td>320</td> <td>480</td> <td>1,300</td> </tr> <tr> <td>141.732 (Note 2)</td> <td></td> <td>137.795</td> <td>106.299</td> <td>70.866</td> <td>38.976</td> <td>12.598</td> <td>18.898</td> <td>51.181</td> </tr> <tr> <td rowspan="2">FT-45X</td> <td>1,600</td> <td></td> <td>1,600</td> <td>1,600</td> <td>1,400</td> <td>800</td> <td>210</td> <td>540</td> <td>1,600</td> </tr> <tr> <td>62.992 (Note 2)</td> <td></td> <td>62.992 (Note 2)</td> <td>62.992 (Note 2)</td> <td>55.118</td> <td>31.496</td> <td>8.268</td> <td>21.260</td> <td>62.992 (Note 2)</td> </tr> <tr> <td rowspan="2">FT-H35-M2</td> <td>3,500</td> <td></td> <td>1,600</td> <td>1,200</td> <td>780</td> <td>500</td> <td>150</td> <td>280</td> <td>800</td> </tr> <tr> <td>137.795</td> <td></td> <td>62.992</td> <td>47.244</td> <td>30.709</td> <td>19.685</td> <td>5.906</td> <td>11.024</td> <td>31.496</td> </tr> <tr> <td rowspan="2">FT-H20W-M1</td> <td>1,600</td> <td></td> <td>1,600</td> <td>1,500</td> <td>950</td> <td>560</td> <td>190</td> <td>140</td> <td>400</td> </tr> <tr> <td>62.992 (Note 2)</td> <td></td> <td>62.992 (Note 2)</td> <td>59.055</td> <td>37.402</td> <td>22.047</td> <td>7.480</td> <td>5.512</td> <td>15.748</td> </tr> <tr> <td rowspan="2">FT-H20-M1</td> <td>1,600</td> <td></td> <td>1,600</td> <td>1,300</td> <td>780</td> <td>500</td> <td>150</td> <td>280</td> <td>840</td> </tr> <tr> <td>62.992 (Note 2)</td> <td></td> <td>62.992 (Note 2)</td> <td>51.181</td> <td>30.709</td> <td>19.685</td> <td>5.906</td> <td>11.024</td> <td>33.071</td> </tr> <tr> <td rowspan="3">FT-H20-J50-S FT-H20-J30-S FT-H20-J20-S</td> <td>1,600</td> <td></td> <td>960</td> <td>740</td> <td>450</td> <td>290</td> <td>80</td> <td>150</td> <td>410</td> </tr> <tr> <td>62.992 (Note 2)</td> <td></td> <td>37.795</td> <td>29.134</td> <td>17.717</td> <td>11.417</td> <td>3.150</td> <td>5.906</td> <td>16.142</td> </tr> <tr> <td></td> <td></td> <td></td> <td></td> <td></td> <td></td> <td></td> <td></td> <td></td> </tr> </tbody> </table>	Fiber	Amplifier		FX-500 series					FX-101□	FX-102□	Mode		HYPR	U-LG	LONG	STD	FAST	H-SP	FT-43	3,600		3,400	2,600	1,700	970	310	510	1,400	141.732 (Note 2)		133.858	102.362	66.929	38.189	12.205	20.079	55.118	FT-42	3,600		3,600	3,600	2,100	1,150	370	500	1,700	141.732 (Note 2)		141.732 (Note 2)	141.732 (Note 2)	82.677	45.276	14.567	19.685	66.929	FT-42W	3,600		3,500	2,700	1,800	990	320	480	1,300	141.732 (Note 2)		137.795	106.299	70.866	38.976	12.598	18.898	51.181	FT-45X	1,600		1,600	1,600	1,400	800	210	540	1,600	62.992 (Note 2)		62.992 (Note 2)	62.992 (Note 2)	55.118	31.496	8.268	21.260	62.992 (Note 2)	FT-H35-M2	3,500		1,600	1,200	780	500	150	280	800	137.795		62.992	47.244	30.709	19.685	5.906	11.024	31.496	FT-H20W-M1	1,600		1,600	1,500	950	560	190	140	400	62.992 (Note 2)		62.992 (Note 2)	59.055	37.402	22.047	7.480	5.512	15.748	FT-H20-M1	1,600		1,600	1,300	780	500	150	280	840	62.992 (Note 2)		62.992 (Note 2)	51.181	30.709	19.685	5.906	11.024	33.071	FT-H20-J50-S FT-H20-J30-S FT-H20-J20-S	1,600		960	740	450	290	80	150	410	62.992 (Note 2)		37.795	29.134	17.717	11.417	3.150	5.906	16.142									
		Fiber		Amplifier		FX-500 series							FX-101□	FX-102□																																																																																																																																																																							
			Mode		HYPR	U-LG	LONG	STD	FAST	H-SP																																																																																																																																																																											
		FT-43	3,600		3,400	2,600	1,700	970	310	510	1,400																																																																																																																																																																										
			141.732 (Note 2)		133.858	102.362	66.929	38.189	12.205	20.079	55.118																																																																																																																																																																										
		FT-42	3,600		3,600	3,600	2,100	1,150	370	500	1,700																																																																																																																																																																										
			141.732 (Note 2)		141.732 (Note 2)	141.732 (Note 2)	82.677	45.276	14.567	19.685	66.929																																																																																																																																																																										
		FT-42W	3,600		3,500	2,700	1,800	990	320	480	1,300																																																																																																																																																																										
			141.732 (Note 2)		137.795	106.299	70.866	38.976	12.598	18.898	51.181																																																																																																																																																																										
		FT-45X	1,600		1,600	1,600	1,400	800	210	540	1,600																																																																																																																																																																										
62.992 (Note 2)			62.992 (Note 2)	62.992 (Note 2)	55.118	31.496	8.268	21.260	62.992 (Note 2)																																																																																																																																																																												
FT-H35-M2	3,500		1,600	1,200	780	500	150	280	800																																																																																																																																																																												
	137.795		62.992	47.244	30.709	19.685	5.906	11.024	31.496																																																																																																																																																																												
FT-H20W-M1	1,600		1,600	1,500	950	560	190	140	400																																																																																																																																																																												
	62.992 (Note 2)		62.992 (Note 2)	59.055	37.402	22.047	7.480	5.512	15.748																																																																																																																																																																												
FT-H20-M1	1,600		1,600	1,300	780	500	150	280	840																																																																																																																																																																												
	62.992 (Note 2)		62.992 (Note 2)	51.181	30.709	19.685	5.906	11.024	33.071																																																																																																																																																																												
FT-H20-J50-S FT-H20-J30-S FT-H20-J20-S	1,600		960	740	450	290	80	150	410																																																																																																																																																																												
	62.992 (Note 2)		37.795	29.134	17.717	11.417	3.150	5.906	16.142																																																																																																																																																																												
Expansion lens for vacuum fiber (Note 1)	FV-LE1	<p>Sensing range increases by 4 times or more.</p> <ul style="list-style-type: none"> Ambient temperature: -60 to +350 °C -76 to +662 °F (Note 4) Beam dia: \varnothing3.6 mm \varnothing0.142 in <p>Sensing range (mm in) [Lens on both sides] (Note 3)</p> <table border="1"> <thead> <tr> <th rowspan="2">Fiber</th> <th colspan="2">Amplifier</th> <th colspan="5">FX-500 series</th> <th rowspan="2">FX-101□</th> <th rowspan="2">FX-102□</th> </tr> <tr> <th>Mode</th> <th></th> <th>HYPR</th> <th>U-LG</th> <th>LONG</th> <th>STD</th> <th>FAST</th> <th>H-SP</th> </tr> </thead> <tbody> <tr> <td rowspan="2">FT-H30-M1V-S</td> <td>3,600</td> <td></td> <td>3,400</td> <td>1,500</td> <td>900</td> <td>370</td> <td>450</td> <td>1,600</td> </tr> <tr> <td>141.732 (Note 2)</td> <td></td> <td>141.732 (Note 2)</td> <td>133.858</td> <td>59.055</td> <td>35.433</td> <td>14.567</td> <td>17.717</td> <td>62.992</td> </tr> </tbody> </table>	Fiber	Amplifier		FX-500 series					FX-101□	FX-102□	Mode		HYPR	U-LG	LONG	STD	FAST	H-SP	FT-H30-M1V-S	3,600		3,400	1,500	900	370	450	1,600	141.732 (Note 2)		141.732 (Note 2)	133.858	59.055	35.433	14.567	17.717	62.992																																																																																																																																															
		Fiber		Amplifier		FX-500 series							FX-101□	FX-102□																																																																																																																																																																							
Mode			HYPR	U-LG	LONG	STD	FAST	H-SP																																																																																																																																																																													
FT-H30-M1V-S	3,600		3,400	1,500	900	370	450	1,600																																																																																																																																																																													
	141.732 (Note 2)		141.732 (Note 2)	133.858	59.055	35.433	14.567	17.717	62.992																																																																																																																																																																												
Vacuum-resistant side-view lens (Note 1)	FV-SV2	<p>Beam axis is bent by 90°.</p> <ul style="list-style-type: none"> Ambient temperature: -60 to +300 °C -76 to +572 °F (Note 4) Beam dia: \varnothing3.7 mm \varnothing0.146 in <p>Sensing range (mm in) [Lens on both sides] (Note 3)</p> <table border="1"> <thead> <tr> <th rowspan="2">Fiber</th> <th colspan="2">Amplifier</th> <th colspan="5">FX-500 series</th> <th rowspan="2">FX-101□</th> <th rowspan="2">FX-102□</th> </tr> <tr> <th>Mode</th> <th></th> <th>HYPR</th> <th>U-LG</th> <th>LONG</th> <th>STD</th> <th>FAST</th> <th>H-SP</th> </tr> </thead> <tbody> <tr> <td rowspan="2">FT-H30-M1V-S</td> <td>3,600</td> <td></td> <td>3,400</td> <td>1,500</td> <td>900</td> <td>370</td> <td>450</td> <td>1,600</td> </tr> <tr> <td>141.732 (Note 2)</td> <td></td> <td>141.732 (Note 2)</td> <td>133.858</td> <td>59.055</td> <td>35.433</td> <td>14.567</td> <td>17.717</td> <td>62.992</td> </tr> </tbody> </table>	Fiber	Amplifier		FX-500 series					FX-101□	FX-102□	Mode		HYPR	U-LG	LONG	STD	FAST	H-SP	FT-H30-M1V-S	3,600		3,400	1,500	900	370	450	1,600	141.732 (Note 2)		141.732 (Note 2)	133.858	59.055	35.433	14.567	17.717	62.992																																																																																																																																															
		Fiber		Amplifier		FX-500 series							FX-101□	FX-102□																																																																																																																																																																							
Mode			HYPR	U-LG	LONG	STD	FAST	H-SP																																																																																																																																																																													
FT-H30-M1V-S	3,600		3,400	1,500	900	370	450	1,600																																																																																																																																																																													
	141.732 (Note 2)		141.732 (Note 2)	133.858	59.055	35.433	14.567	17.717	62.992																																																																																																																																																																												

- Notes: 1) Be careful sure to use it only after you have adjusted it sufficiently when installing the thru-beam type fiber equipped with the expansion lens, as the beam envelope becomes narrow and alignment is difficult.
 2) The fiber cable length practically limits the sensing range.
 3) The fiber cable length for the **FT-H30-M1V-S** is 1 m **3.28 ft**. The sensing ranges in HYPR, U-LG and LONG of **FX-500** series, in **FX-102□** take into account the length of the **FT-J8** atmospheric side fiber.
 4) Refer to P.10~ for the ambient temperature of fibers to be used in combination.

New product introduction

Tough Fiber

Fiber Selection Guide

Choose by model

Choose by shape/application

Viewing new models

Fibers

Super Quality

Threaded Type

Cylindrical Type

Sleeve

Flat Type

Small Spot

Narrow Beam

Wide Beam

Convergent Reflective Type

Retroreflective Type

Chemical-resistant

Heat-resistant

Vacuum-resistant

Liquid Leak / Liquid Detection

Fiber Options

Fiber Dimensions

Thru-beam Type

Retroreflective Type

Reflective Type

Others

Amplifiers

FX-500 series



FX-100 series

INDEX

Earlier models comparison table

Fiber options

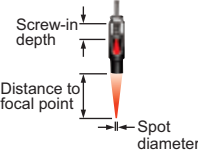
Lens (For reflective type fiber)

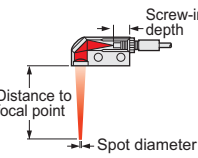
Designation	Model No.	Description													
For reflective type fiber	Pinpoint spot lens	FX-MR1	 <p>Pinpoint spot of $\varnothing 0.5$ mm $\varnothing 0.020$ in. Enables detection of minute objects or small marks.</p> <ul style="list-style-type: none"> Distance to focal point: 6 ± 1 mm 0.236 ± 0.039 in Applicable fibers: FD-42G, FD-42GW Ambient temperature: -40 to $+70$ °C -40 to $+158$ °F (Note) 												
	Zoom lens	FX-MR2	 <p>The spot diameter is adjustable from $\varnothing 0.7$ to $\varnothing 2$ mm $\varnothing 0.028$ to $\varnothing 0.079$ in according to how much the fiber is screwed in.</p> <ul style="list-style-type: none"> Applicable fibers: FD-42G, FD-42GW Ambient temperature: -40 to $+70$ °C -40 to $+158$ °F (Note) Accessory: MS-EX3 (mounting bracket) <table border="1"> <caption>Sensing range</caption> <thead> <tr> <th>Screw-in depth</th> <th>Distance to focal point</th> <th>Spot diameter</th> </tr> </thead> <tbody> <tr> <td>7 mm</td> <td>18.5 mm approx.</td> <td>$\varnothing 0.7$ mm</td> </tr> <tr> <td>12 mm</td> <td>27 mm approx.</td> <td>$\varnothing 1.2$ mm</td> </tr> <tr> <td>14 mm</td> <td>43 mm approx.</td> <td>$\varnothing 2.0$ mm</td> </tr> </tbody> </table>	Screw-in depth	Distance to focal point	Spot diameter	7 mm	18.5 mm approx.	$\varnothing 0.7$ mm	12 mm	27 mm approx.	$\varnothing 1.2$ mm	14 mm	43 mm approx.	$\varnothing 2.0$ mm
	Screw-in depth	Distance to focal point	Spot diameter												
	7 mm	18.5 mm approx.	$\varnothing 0.7$ mm												
	12 mm	27 mm approx.	$\varnothing 1.2$ mm												
14 mm	43 mm approx.	$\varnothing 2.0$ mm													
Finest spot lens	FX-MR3	 <p>Extremely fine spot of $\varnothing 0.15$ mm $\varnothing 0.006$ in approx. achieved.</p> <ul style="list-style-type: none"> Applicable fibers: FD-EG31, FD-EG30, FD-42G, FD-42GW, FD-32G, FD-32GX Ambient temperature: -40 to $+70$ °C -40 to $+158$ °F (Note) <table border="1"> <caption>Sensing range</caption> <thead> <tr> <th>Fiber model No.</th> <th>Distance to focal point</th> <th>Spot diameter</th> </tr> </thead> <tbody> <tr> <td>FD-EG31</td> <td>7.5 ± 0.5 mm</td> <td>$\varnothing 0.15$ mm approx.</td> </tr> <tr> <td>FD-EG30</td> <td>7.5 ± 0.5 mm</td> <td>$\varnothing 0.3$ mm approx.</td> </tr> <tr> <td>FD-42G/42GW FD-32G/32GX</td> <td>7.5 ± 0.5 mm</td> <td>$\varnothing 0.5$ mm approx.</td> </tr> </tbody> </table>	Fiber model No.	Distance to focal point	Spot diameter	FD-EG31	7.5 ± 0.5 mm	$\varnothing 0.15$ mm approx.	FD-EG30	7.5 ± 0.5 mm	$\varnothing 0.3$ mm approx.	FD-42G/42GW FD-32G/32GX	7.5 ± 0.5 mm	$\varnothing 0.5$ mm approx.	
Fiber model No.	Distance to focal point	Spot diameter													
FD-EG31	7.5 ± 0.5 mm	$\varnothing 0.15$ mm approx.													
FD-EG30	7.5 ± 0.5 mm	$\varnothing 0.3$ mm approx.													
FD-42G/42GW FD-32G/32GX	7.5 ± 0.5 mm	$\varnothing 0.5$ mm approx.													
Finest spot lens	FX-MR6	 <p>Extremely fine spot of $\varnothing 0.1$ mm $\varnothing 0.004$ in approx. achieved.</p> <ul style="list-style-type: none"> Applicable fibers: FD-EG31, FD-EG30, FD-42G, FD-42GW, FD-32G, FD-32GX Ambient temperature: -20 to $+60$ °C -4 to $+140$ °F (Note) <table border="1"> <caption>Sensing range</caption> <thead> <tr> <th>Fiber model No.</th> <th>Distance to focal point</th> <th>Spot diameter</th> </tr> </thead> <tbody> <tr> <td>FD-EG31</td> <td>7 ± 0.5 mm</td> <td>$\varnothing 0.1$ mm approx.</td> </tr> <tr> <td>FD-EG30</td> <td>7 ± 0.5 mm</td> <td>$\varnothing 0.2$ mm approx.</td> </tr> <tr> <td>FD-42G/42GW FD-32G/32GX</td> <td>7 ± 0.5 mm</td> <td>$\varnothing 0.4$ mm approx.</td> </tr> </tbody> </table>	Fiber model No.	Distance to focal point	Spot diameter	FD-EG31	7 ± 0.5 mm	$\varnothing 0.1$ mm approx.	FD-EG30	7 ± 0.5 mm	$\varnothing 0.2$ mm approx.	FD-42G/42GW FD-32G/32GX	7 ± 0.5 mm	$\varnothing 0.4$ mm approx.	
Fiber model No.	Distance to focal point	Spot diameter													
FD-EG31	7 ± 0.5 mm	$\varnothing 0.1$ mm approx.													
FD-EG30	7 ± 0.5 mm	$\varnothing 0.2$ mm approx.													
FD-42G/42GW FD-32G/32GX	7 ± 0.5 mm	$\varnothing 0.4$ mm approx.													
Zoom lens (side-view type)	FX-MR5	 <p>FX-MR2 is converted into a side-view type and can be mounted in a very small space.</p> <ul style="list-style-type: none"> Applicable fibers: FD-42G, FD-42GW Ambient temperature: -40 to $+70$ °C -40 to $+158$ °F (Note) <table border="1"> <caption>Sensing range</caption> <thead> <tr> <th>Screw-in depth</th> <th>Distance to focal point</th> <th>Spot diameter</th> </tr> </thead> <tbody> <tr> <td>8 mm</td> <td>13 mm approx.</td> <td>$\varnothing 0.5$ mm</td> </tr> <tr> <td>10 mm</td> <td>15 mm approx.</td> <td>$\varnothing 0.8$ mm</td> </tr> <tr> <td>14 mm</td> <td>30 mm approx.</td> <td>$\varnothing 3.0$ mm</td> </tr> </tbody> </table>	Screw-in depth	Distance to focal point	Spot diameter	8 mm	13 mm approx.	$\varnothing 0.5$ mm	10 mm	15 mm approx.	$\varnothing 0.8$ mm	14 mm	30 mm approx.	$\varnothing 3.0$ mm	
Screw-in depth	Distance to focal point	Spot diameter													
8 mm	13 mm approx.	$\varnothing 0.5$ mm													
10 mm	15 mm approx.	$\varnothing 0.8$ mm													
14 mm	30 mm approx.	$\varnothing 3.0$ mm													

Note: Refer to P.11~ for the ambient temperature of fibers to be used in combination.

Model No. when ordering heat-resistant fibers individually as replacement parts

- Heat-resistant side fiber **one pair set**
FT-H20-J20, FT-H20-J30, FT-H20-J50, FT-H20-VJ50, FT-H20-VJ80

Model No. when ordering vacuum-resistant fibers individually as replacement parts

- Vacuum-resistant fiber **FD-H30W-M1V** (one pair set)
- Fiber at atmospheric side **FT-J8** (one pair set)
- Photo-terminal **FV-BR1** (one pair set)
- Mouting bracket for **FD-H30-KZ1V(-S)** **MS-FD-2**

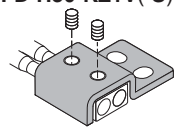

Accessories (attached with fibers)

- RF-003** (FR-KZ50E/KZ50H exclusive reflector)
- RF-13** (Reflective tape)
- FX-CT1** (Fiber cutter)
- FX-CT2** (Fiber cutter)
- FX-CT3** (Fiber cutter)
- FX-AT2** (Attachment for fixed-length fiber, Orange)
- FX-AT3** (Attachment for $\varnothing 2.2$ mm $\varnothing 0.087$ in fiber, Clear orange)
- FX-AT4** (Attachment for $\varnothing 1$ mm $\varnothing 0.039$ in fiber, Black)
- FX-AT5** (Attachment for $\varnothing 1.3$ mm $\varnothing 0.051$ in fiber, Gray)
- FX-AT6** (Attachment for $\varnothing 1$ mm $\varnothing 0.039$ in / $\varnothing 1.3$ mm $\varnothing 0.051$ in mixed fiber, Black / Gray)
- MS-FD-2** (Fiber mouting bracket)

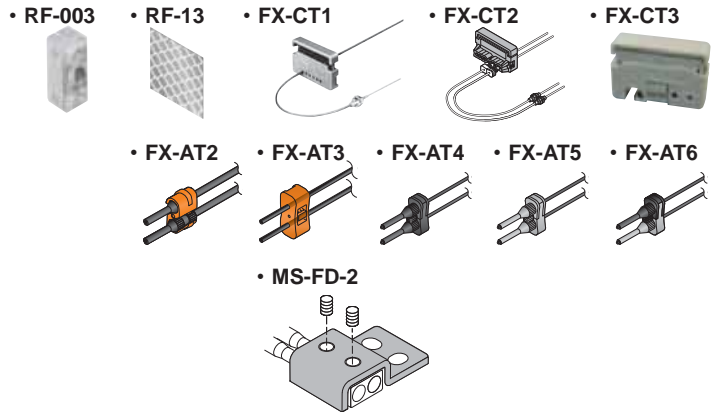

New product introduction
Tough Fiber
Fiber Selection Guide
Choose by model
Choose by shape/application
Viewing new models

Fibers
Super Quality
Threaded Type
Cylindrical Type
Sleeve
Flat Type
Small Spot
Narrow Beam
Wide Beam
Convergent Reflective Type
Retroreflective Type
Chemical-resistant
Heat-resistant
Vacuum-resistant
Liquid Leak / Liquid Detection

Fiber Options
Fiber Dimensions
Thru-beam Type
Retroreflective Type
Reflective Type
Others

Amplifiers
FX-500 series
FX-100 series

INDEX

Earlier models comparison table

Fiber options

Others

Designation	Model No.	Description				
Protective tube (For thru-beam type fiber)	FTP-500 (0.5 m 1.640 ft)	For M4 thread	Applicable fibers	FT-42	FT-43	The protective tube, made of non-corrosive stainless steel, protects the inner fiber cable from any external forces.
	FTP-1000 (1 m 3.281 ft)			FT-42S	FT-H13-FM2	
	FTP-1500 (1.5 m 4.921 ft)			FT-42W		
	FTP-N500 (0.5 m 1.640 ft)	For M3 thread		FT-31	FD-31	
	FTP-N1000 (1 m 3.281 ft)			FT-31S	FD-31W	
	FTP-N1500 (1.5 m 4.921 ft)			FT-31W		
Protective tube (For reflective type fiber)	FDP-500 (0.5 m 1.640 ft)	For M6 thread	FD-61	FD-62		
	FDP-1000 (1 m 3.281 ft)		FD-61G	FD-H13-FM2		
	FDP-1500 (1.5 m 4.921 ft)		FD-61S			
	FDP-N500 (0.5 m 1.640 ft)	For M4 thread	FD-41	FD-41S		
	FDP-N1000 (1 m 3.281 ft)		FD-41W	FD-41SW		
	FDP-N1500 (1.5 m 4.921 ft)					
Fiber bender	FB-1	The fiber bender bends the sleeve part of the fiber head at the proper radius. (Note 1)				
Universal sensor mounting stand (Note 2)	MS-AJ1-F	Horizontal mounting type	Mounting stand assembly for fiber (For M3, M4 or M6 threaded head fiber)			
	MS-AJ2-F	Vertical mounting type				
Liquid inflow prevention joint (Note 2)	MS-FX-01Y	Applicable fibers	FD-HF40Y FD-F41Y	This joint suppresses false operations due to liquid slip-in from the top of the protective tube.		
Protective tube extension joint (Note 2)	MS-FX-02Y			The protective tube can be extended.		
Fiber mounting joint (Note 2)	MS-FX-03Y			The joint is used for mounting fibers on a tank.		
Single core holder	FX-AT15A			The incident light intensity may vary when using a multi-core fiber or a thin type sharp bending fiber. This holder suppresses the variation in the incident light intensity. (Brown)		
Reflector	RF-210	It is available for FR-Z50HW.				
	RF-220	Refer to P.22 for the sensing range of FR-Z50HW to be used in combination.				
	RF-230					

Notes: 1) Do not bend the sleeve part of any side-view type fiber or ultra-small diameter head type fiber.
2) The joint internal ferrule (MS-FX-YF) is available as a spare part. A distorted ferrule may result in leakage.

Liquid inflow prevention joint

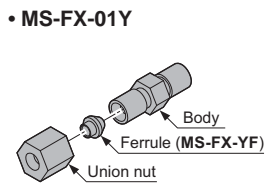

Protective tube extension joint

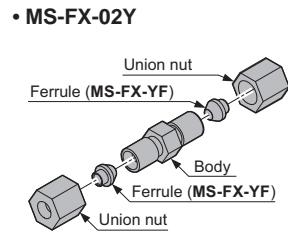

Fiber mounting joint

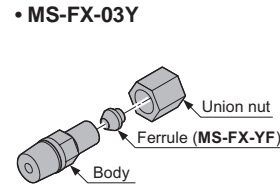

Reflector

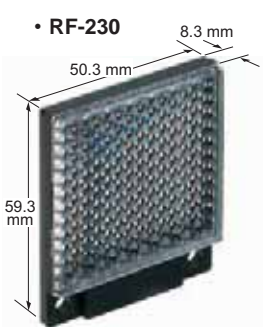
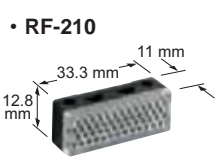

Protective tube

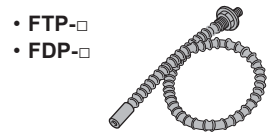

Fiber bender

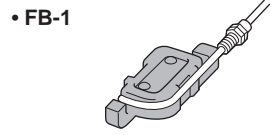

Universal sensor mounting stand

Using the arm which enables adjustment in the horizontal direction, sensing can also be done from above an assembly line.

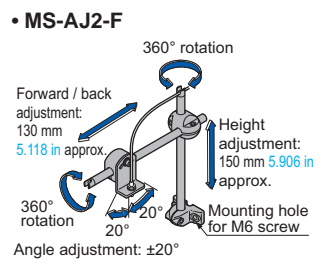
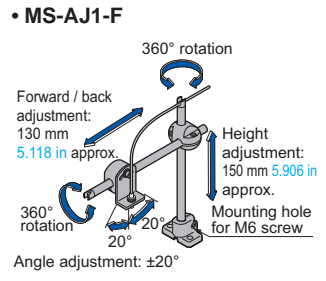

Single core holder



New product introduction
Tough Fiber

Fiber Selection Guide
Choose by model
Choose by shape/application
Viewing new models

Fibers
Super Quality
Threaded Type
Cylindrical Type
Sleeve
Flat Type
Small Spot
Narrow Beam
Wide Beam
Convergent Reflective Type
Retroreflective Type
Chemical-resistant
Heat-resistant
Vacuum-resistant
Liquid Leak / Liquid Detection

Fiber Options

Fiber Dimensions
Thru-beam Type
Retroreflective Type
Reflective Type
Others

Amplifiers
FX-500 series
FX-100 series

INDEX

Earlier models comparison table

DIMENSIONS (Unit: mm in)

Refer to the **FX-500 series** (p.64), **FX-100 series** (p.74) for dimensions of the amplifiers. The CAD data in the dimensions can be downloaded from our website.

Thru-beam type fibers



Dimensions are listed in the order of thru-beam type, retroreflective type, and reflective type, and in alphabetic order of the model No.

FT-140

Free-cut

<with FX-AT3>

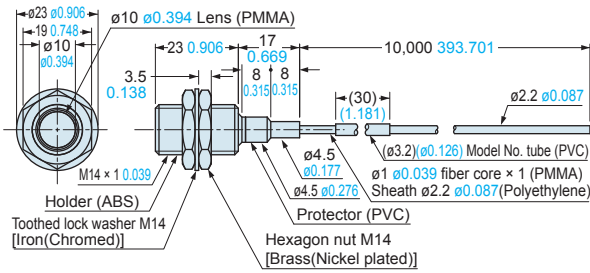

FT-30

<with FX-AT2>

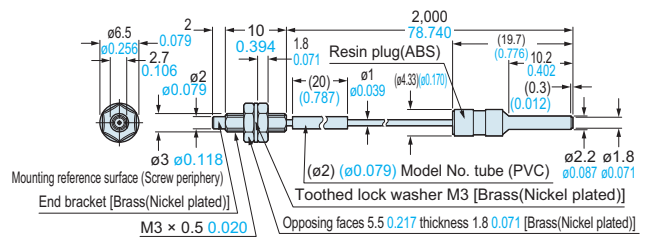

FT-31

Free-cut

<with FX-AT4>

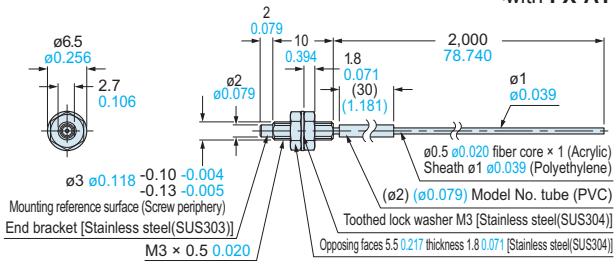

FT-31S

Free-cut

<with FX-AT4>

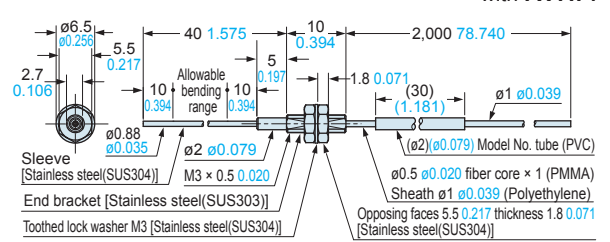

FT-31W

Free-cut

<with FX-AT4>

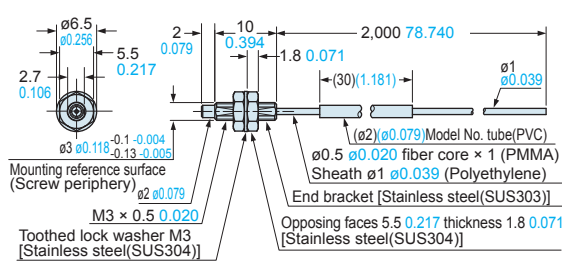

FT-40

<with FX-AT2>

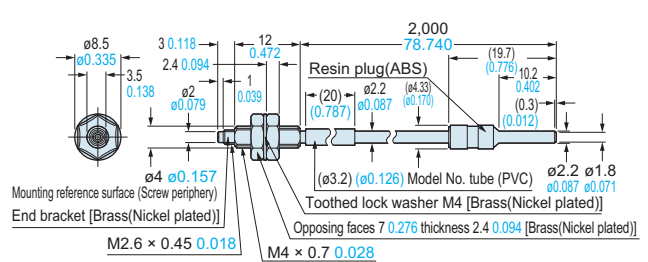

FT-42

Free-cut

<with FX-AT3>

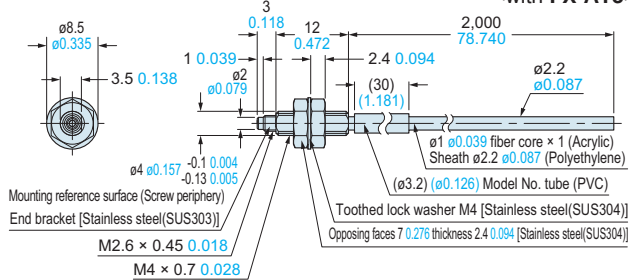

FT-42S

Free-cut

<with FX-AT3>

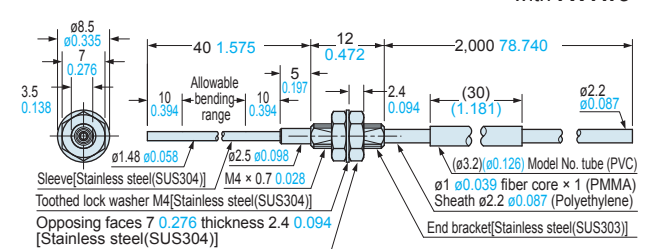

FT-42W

Free-cut

<with FX-AT3>

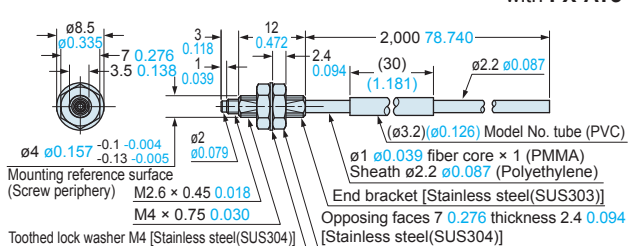

FT-43

Free-cut

<with FX-AT3>

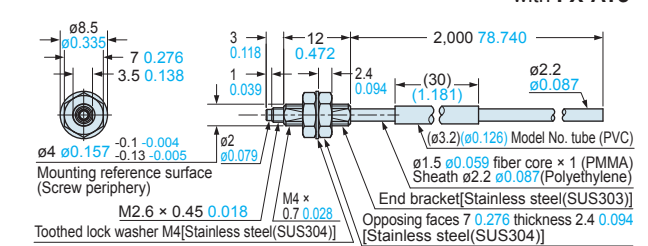

New product introduction
Tough Fiber

Fiber Selection Guide
Choose by model
Choose by shape/application
Viewing new models

Fibers
Super Quality
Threaded Type
Cylindrical Type
Sleeve
Flat Type
Small Spot
Narrow Beam
Wide Beam
Convergent Reflective Type
Retroreflective Type

Chemical-resistant
Heat-resistant
Vacuum-resistant
Liquid Leak/Liquid Detection

Fiber Options
Fiber Dimensions
Thru-beam Type
Retroreflective Type
Reflective Type
Others

Amplifiers
FX-500 series
FX-100 series

INDEX
Earlier models comparison table

DIMENSIONS (Unit: mm in) Refer to the FX-500 series (p.64), FX-100 series (p.74) for dimensions of the amplifiers. The CAD data in the dimensions can be downloaded from our website.

Thru-beam type fibers 

Dimensions are listed in the order of thru-beam type, retroreflective type, and reflective type, and in alphabetic order of the model No.

FT-45X  Free-cut

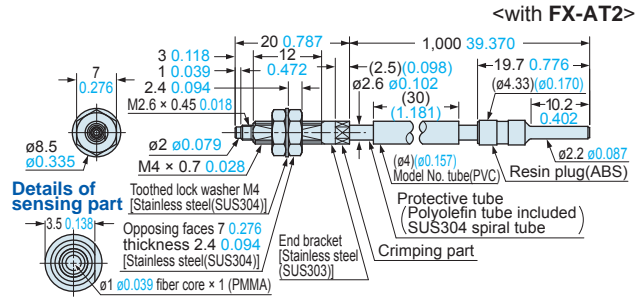

FT-A11  Free-cut

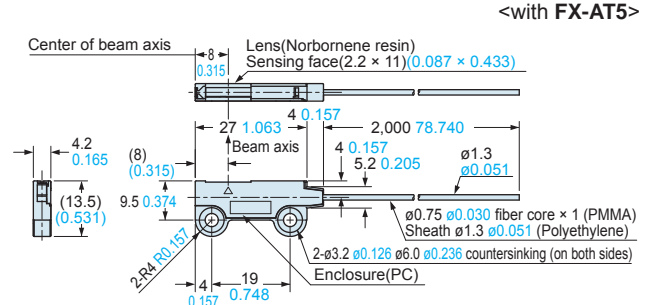

FT-A11W  Free-cut

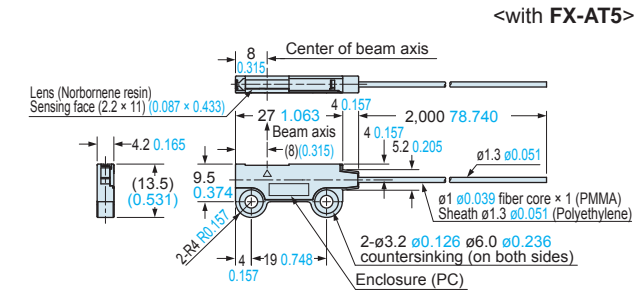

FT-A32  Free-cut

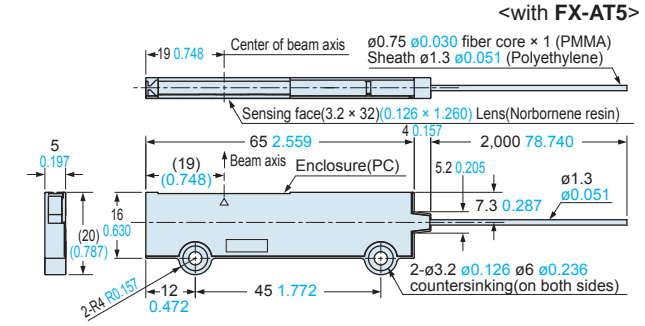

FT-A32W  Free-cut

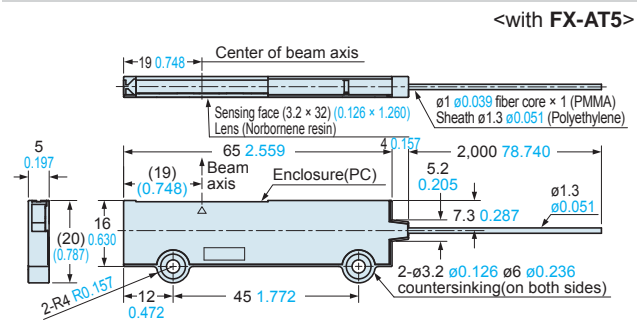

FT-AL05  Free-cut

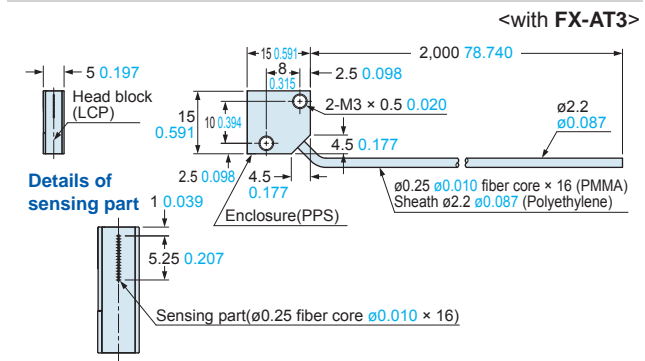

FT-E13  Free-cut

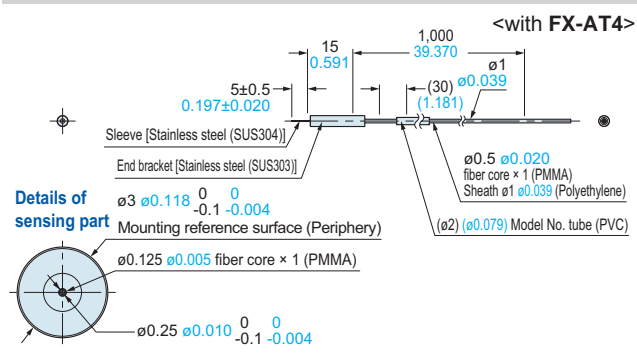

FT-E23  Free-cut

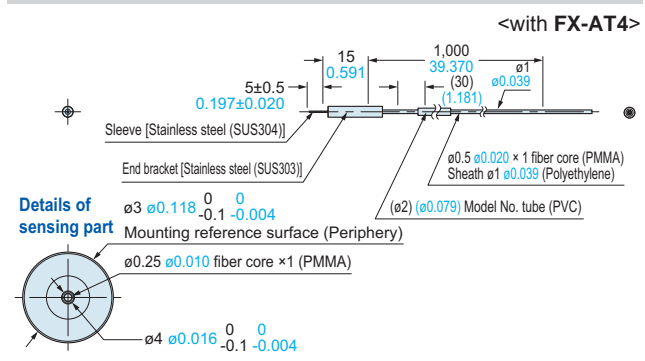

FT-F93  Free-cut

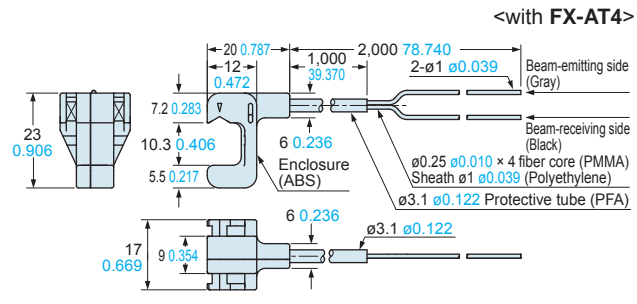

FT-H13-FM2  Free-cut

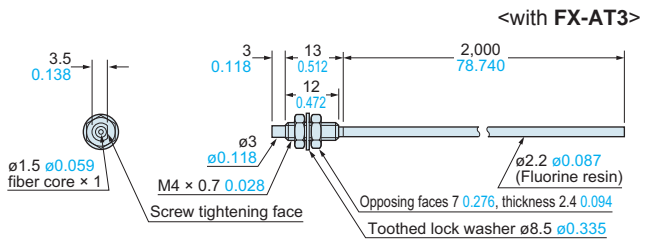

New product introduction
Tough Fiber
Fiber Selection Guide
Choose by model
Choose by shape/application
Viewing new models

Fibers
Super Quality
Threaded Type
Cylindrical Type
Sleeve
Flat Type
Small Spot
Narrow Beam
Wide Beam
Convergent Reflective Type
Retroreflective Type
Chemical-resistant
Heat-resistant
Vacuum-resistant
Liquid Leak / Liquid Detection

Fiber Options
Fiber Dimensions
Thru-beam Type
Retroreflective Type
Reflective Type
Others

Amplifiers
FX-500 series
FX-100 series

INDEX

Earlier models comparison table

DIMENSIONS (Unit: mm in)

Refer to the FX-500 series (p.64), FX-100 series (p.74) for dimensions of the amplifiers. The CAD data in the dimensions can be downloaded from our website.

Thru-beam type fibers



Dimensions are listed in the order of thru-beam type, retroreflective type, and reflective type, and in alphabetic order of the model No.

FT-H20-J20-S FT-H20-J30-S FT-H20-J50-S Free-cut (Note)

Heat-resistant side unit diagram (side view) <with FX-AT3>

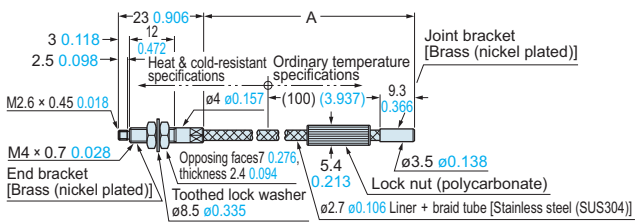

Ordinary temperature side fiber (FT-FM2) connection diagram (front view)

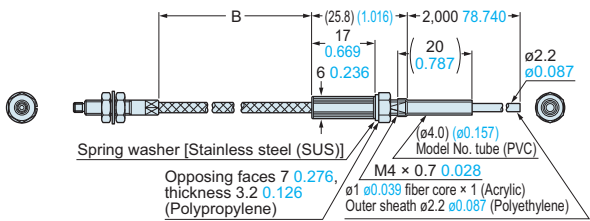

Model No.	A	B
FT-H20-J20-S	200 ⁺²⁵ ₀ 7.874 ^{+0.984} ₀	185 ⁺³⁰ ₀ 7.284 ^{+1.181} ₀
FT-H20-J30-S	300 ⁺²⁵ ₀ 11.811 ^{+0.984} ₀	285 ⁺³⁰ ₀ 11.221 ^{+1.181} ₀
FT-H20-J50-S	500 ⁺²⁵ ₀ 19.685 ^{+0.984} ₀	485 ⁺³⁰ ₀ 19.095 ^{+1.181} ₀

Note: Ordinary temperature side fiber (FT-FM2) only.

FT-H20-M1

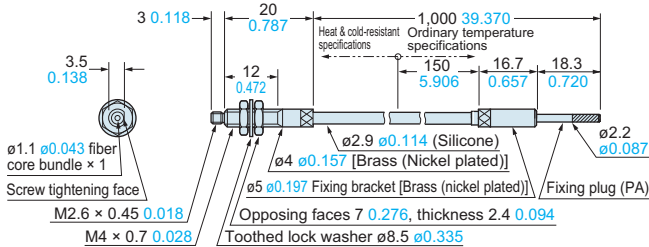

FT-H20-VJ50-S FT-H20-VJ80-S Free-cut (Note)

Heat-resistant side unit diagram (side view) <with FX-AT3>

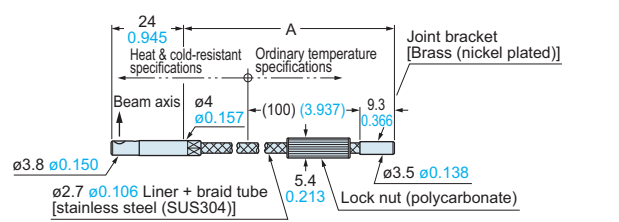

Ordinary temperature side fiber (FT-FM2) connection diagram (front view)

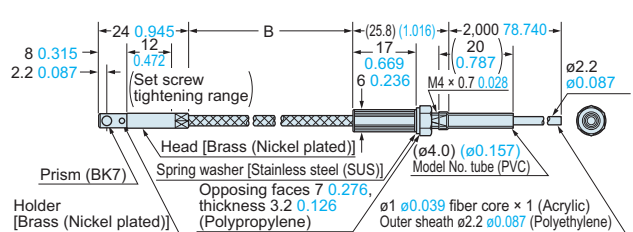

Model No.	A	B
FT-H20-VJ50-S	500 ⁺²⁵ ₀ 19.685 ^{+0.984} ₀	485 ⁺³⁰ ₀ 19.095 ^{+1.181} ₀
FT-H20-VJ80-S	800 ⁺⁵⁰ ₀ 31.496 ^{+1.969} ₀	785 ⁺⁵⁵ ₀ 30.906 ^{+2.165} ₀

Note: Ordinary temperature side fiber (FT-FM2) only.

FT-H20W-M1

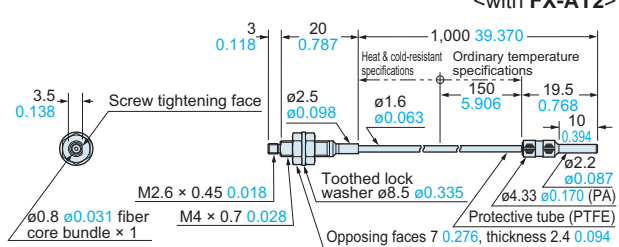

FT-H30-M1V-S

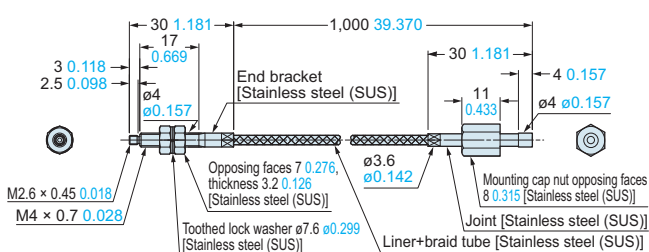

Note: The FT-H30-M1V-S is a set with the FT-H30-M1V, photo-terminal FV-BR1, and atmospheric side fiber FT-J8. Refer to p.51 for dimensions of the atmospheric side fiber and photo-terminals.

FT-H35-M2

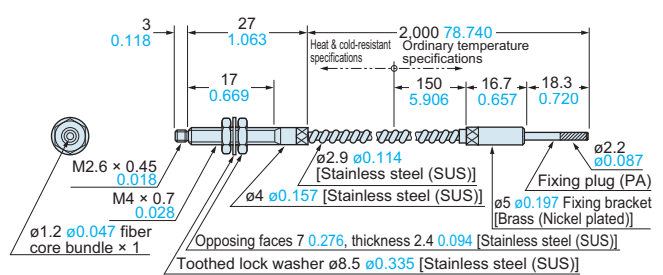

FT-H35-M2S6

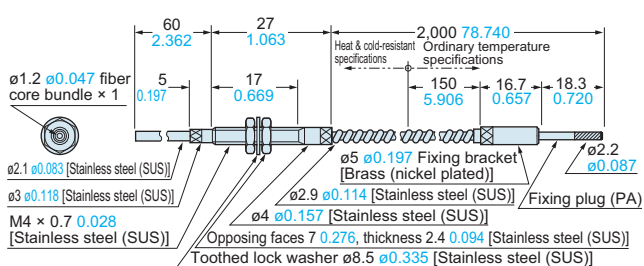

FT-HL80Y Free-cut

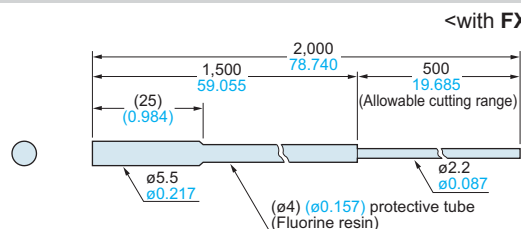

DIMENSIONS (Unit: mm in) Refer to the FX-500 series (p.64), FX-100 series (p.74) for dimensions of the amplifiers. The CAD data in the dimensions can be downloaded from our website.

Thru-beam type fibers

Dimensions are listed in the order of thru-beam type, retroreflective type, and reflective type, and in alphabetic order of the model No.

FT-KS40 Free-cut

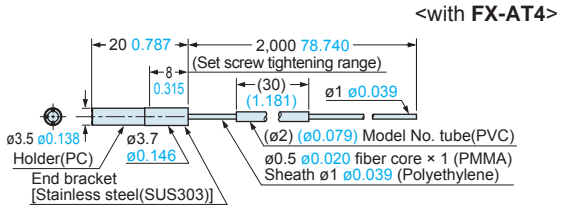

FT-KV26 Free-cut

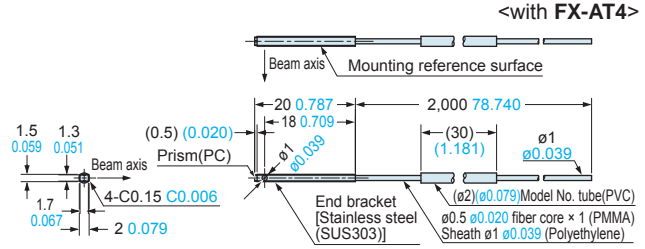

FT-KV40, FT-KV40W Free-cut

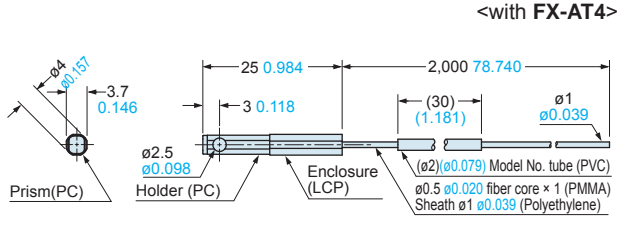

FT-L80Y Free-cut

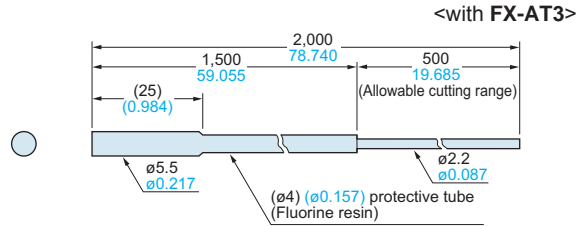

Assembly dimensions with MS-FD-3 (attached mounting bracket)

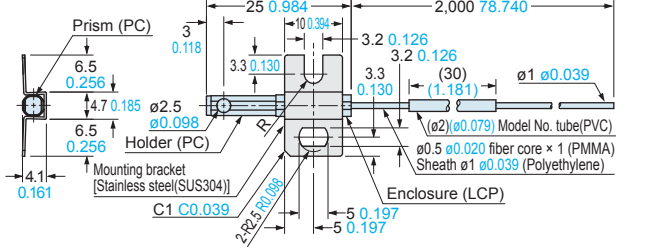

FT-R40 Free-cut

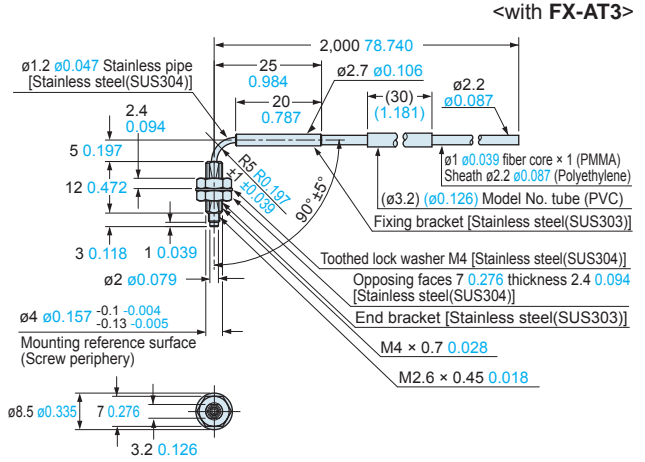

FT-R41W Free-cut

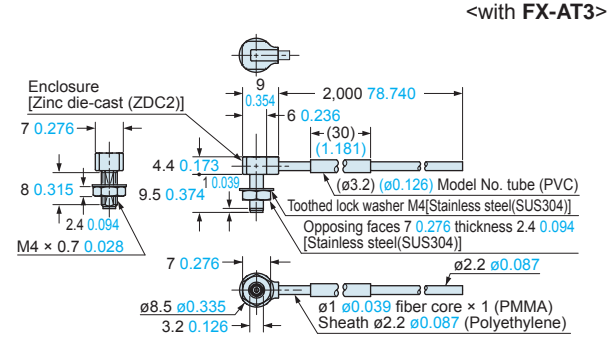

FT-R42W Free-cut

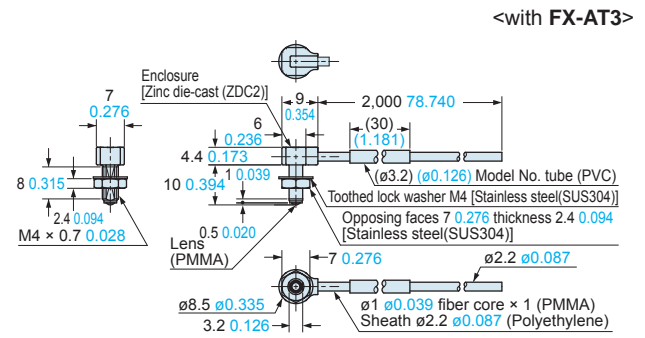

FT-S11 Free-cut

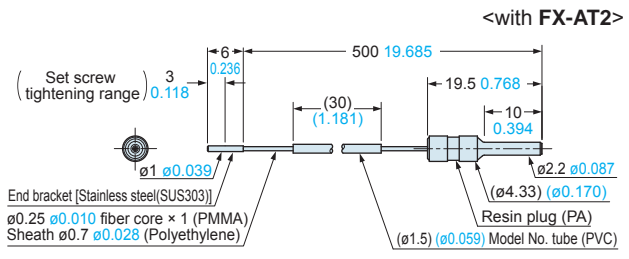

New product introduction
Tough Fiber

Fiber Selection Guide
Choose by model
Choose by shape/application
Viewing new models

Fibers
Super Quality
Threaded Type
Cylindrical Type
Sleeve
Flat Type
Small Spot
Narrow Beam
Wide Beam
Convergent Reflective Type
Retroreflective Type
Chemical-resistant
Heat-resistant
Vacuum-resistant
Liquid Leak / Liquid Detection

Fiber Options

Fiber Dimensions
Thru-beam Type
Retroreflective Type
Reflective Type
Others

Amplifiers
FX-500 series
FX-100 series

INDEX

Earlier models comparison table

DIMENSIONS (Unit: mm in)

Refer to the FX-500 series (p.64), FX-100 series (p.74) for dimensions of the amplifiers. The CAD data in the dimensions can be downloaded from our website.

Thru-beam type fibers



Dimensions are listed in the order of thru-beam type, retroreflective type, and reflective type, and in alphabetic order of the model No.

FT-S20

<with FX-AT2>

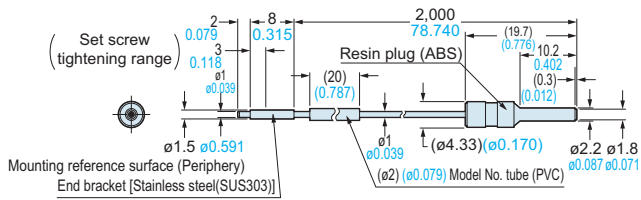

FT-S21

Free-cut <with FX-AT4>

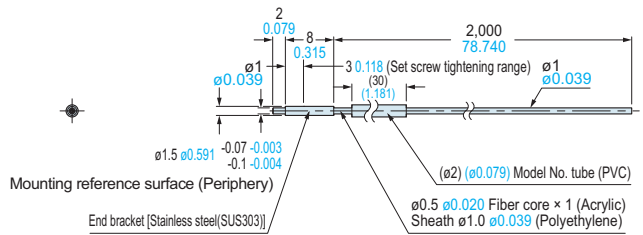

FT-S21W

Free-cut <with FX-AT4>

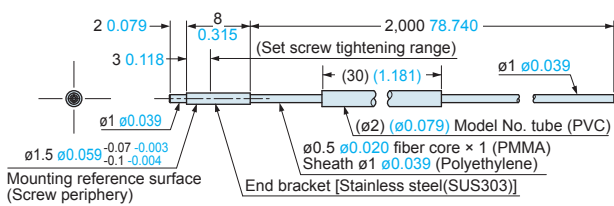

FT-S30

<with FX-AT2>

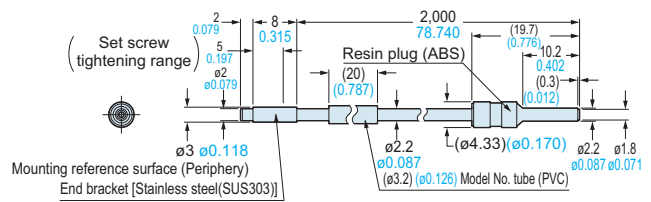

FT-S31W

Free-cut <with FX-AT3>

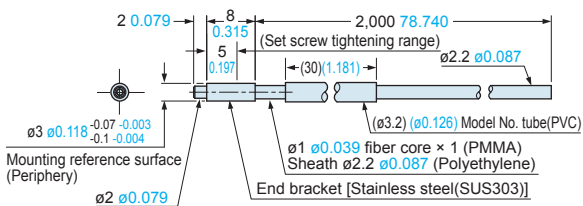

FT-S32

Free-cut <with FX-AT3>

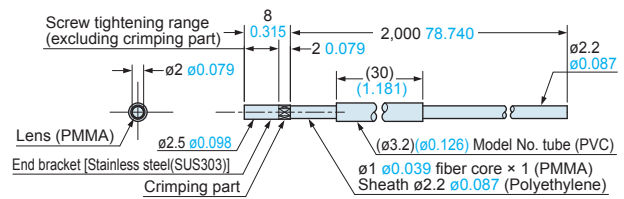

FT-V23

Free-cut <with FX-AT5>

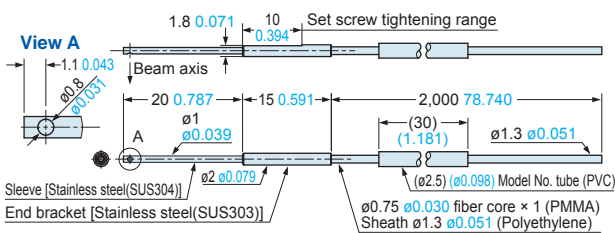

FT-V24W

Free-cut <with FX-AT4>

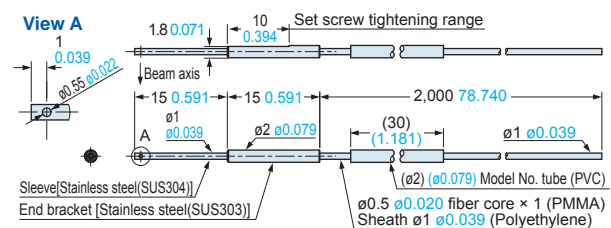

FT-V25

Free-cut <with FX-AT4>

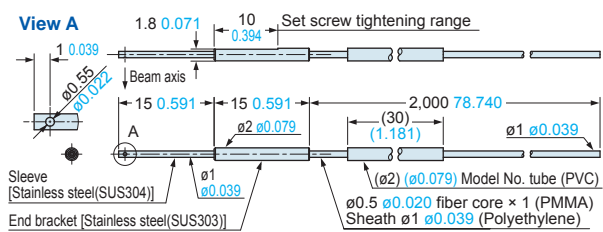

FT-V30

Free-cut <with FX-AT3>

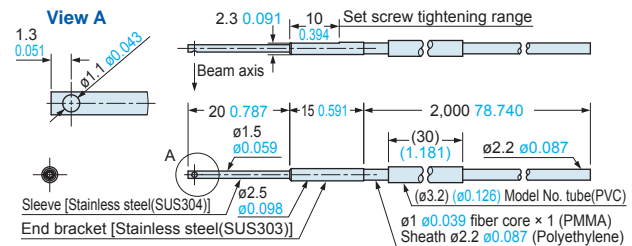

DIMENSIONS (Unit: mm in) Refer to the FX-500 series (p.64), FX-100 series (p.74) for dimensions of the amplifiers. The CAD data in the dimensions can be downloaded from our website.

Thru-beam type fibers

Dimensions are listed in the order of thru-beam type, retroreflective type, and reflective type, and in alphabetic order of the model No.

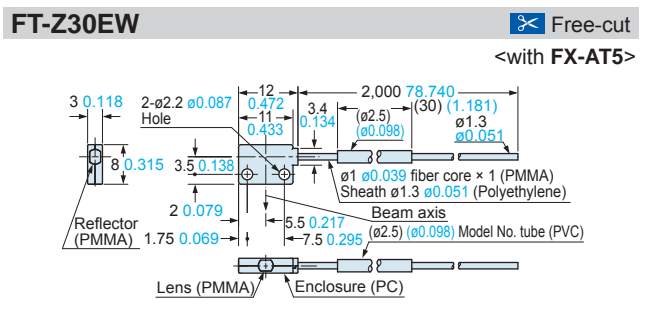
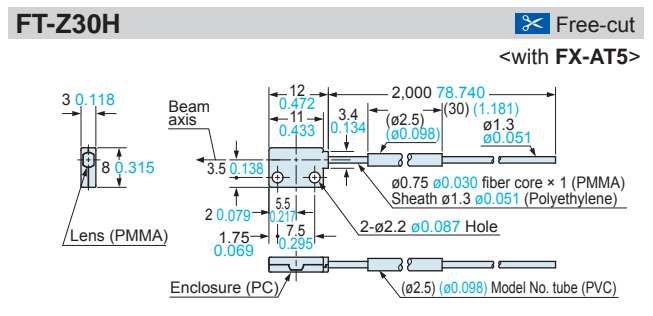
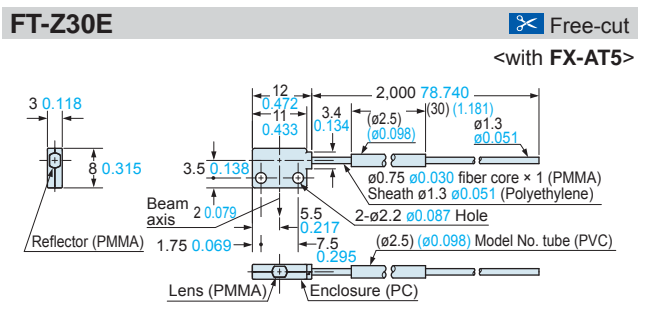
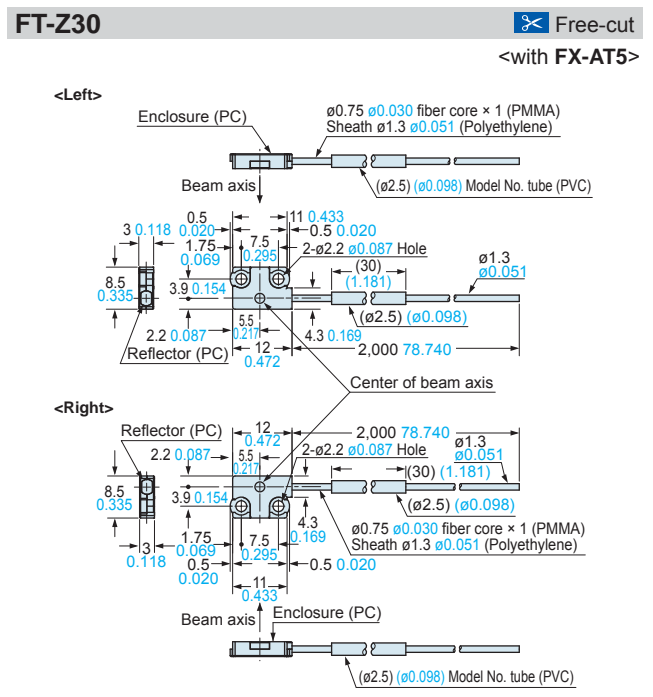
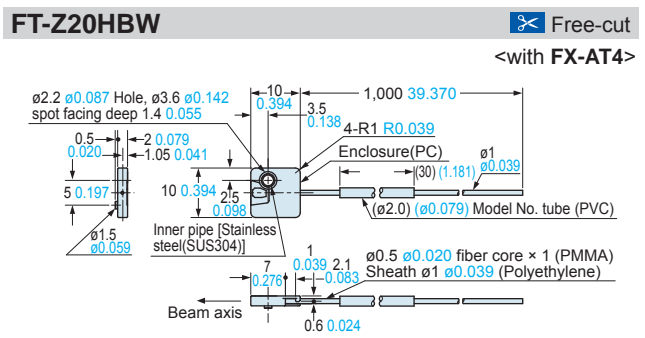
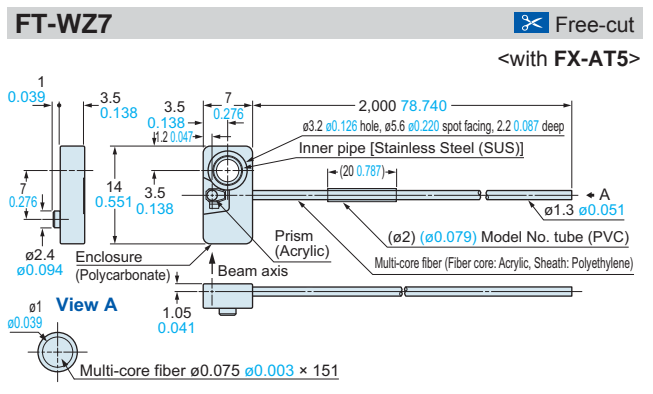
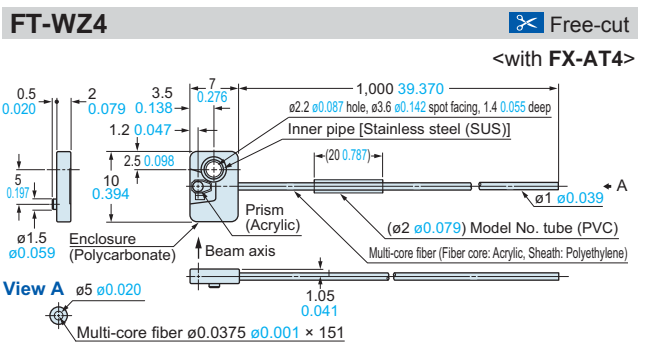
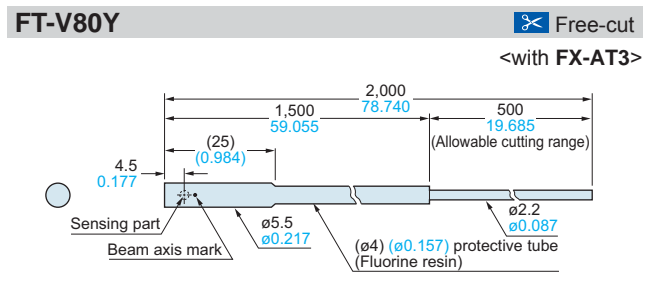
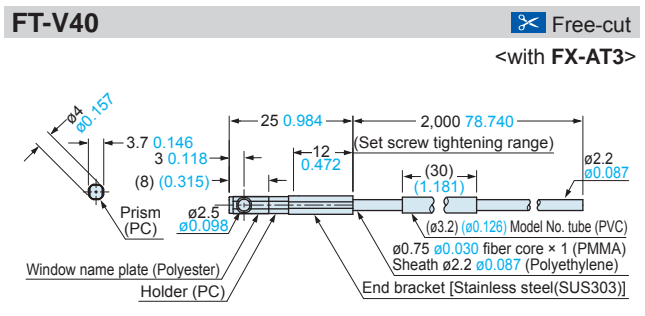

New product introduction
Tough Fiber
Fiber Selection Guide
Choose by model
Choose by shape/application
Viewing new models

Fibers
Super Quality
Threaded Type
Cylindrical Type
Sleeve
Flat Type
Small Spot
Narrow Beam
Wide Beam
Convergent Reflective Type
Retroreflective Type
Chemical-resistant
Heat-resistant
Vacuum-resistant
Liquid Leak / Liquid Detection
Fiber Options
Fiber Dimensions
Thru-beam Type
Retroreflective Type
Reflective Type
Others

Amplifiers
FX-500 series
FX-100 series

INDEX

Earlier models comparison table

DIMENSIONS (Unit: mm in)

Refer to the FX-500 series (p.64), FX-100 series (p.74) for dimensions of the amplifiers. The CAD data in the dimensions can be downloaded from our website.

Reflective type fibers



Dimensions are listed in the order of thru-beam type, retroreflective type, and reflective type, and in alphabetic order of the model No.

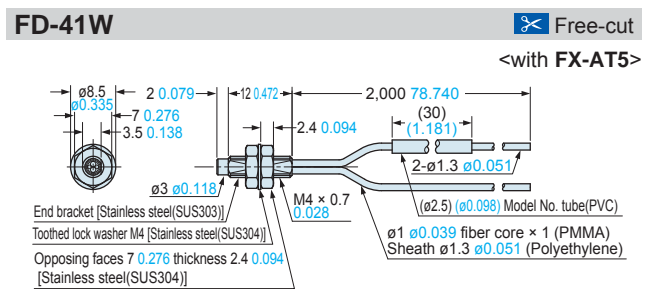
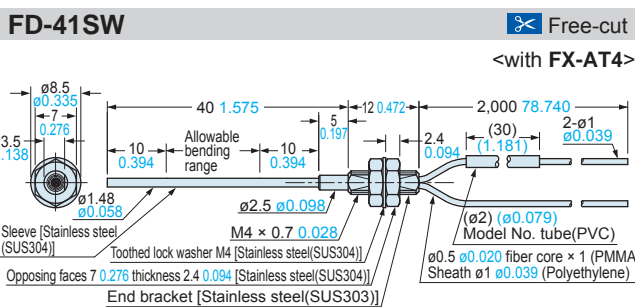
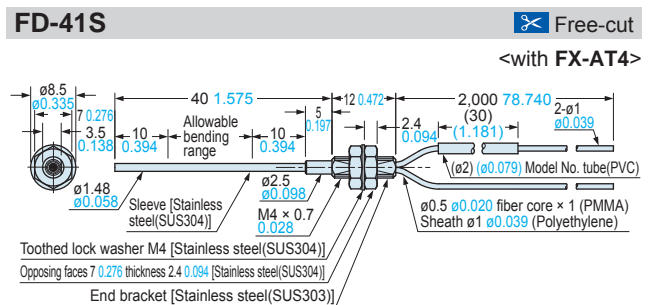
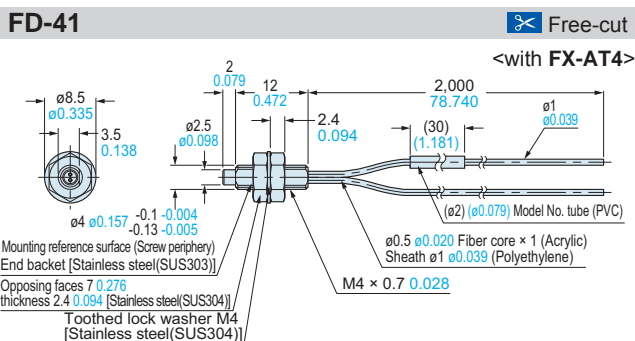
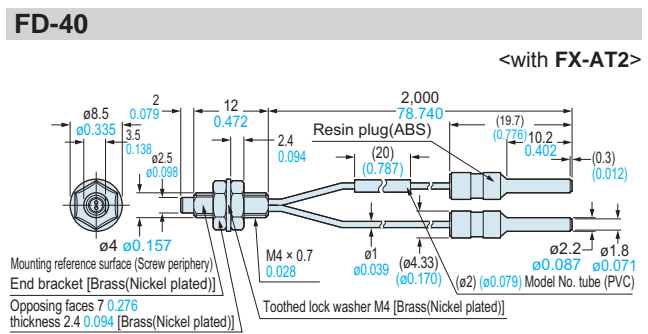
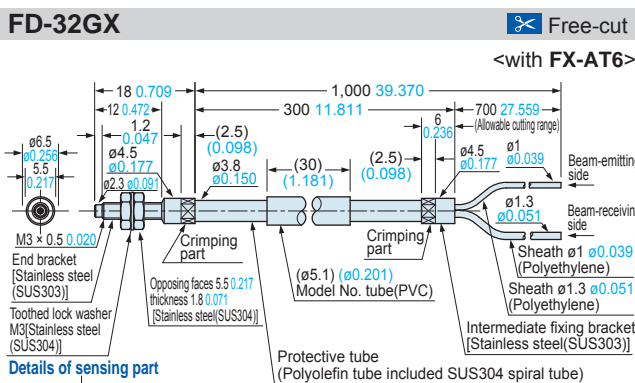
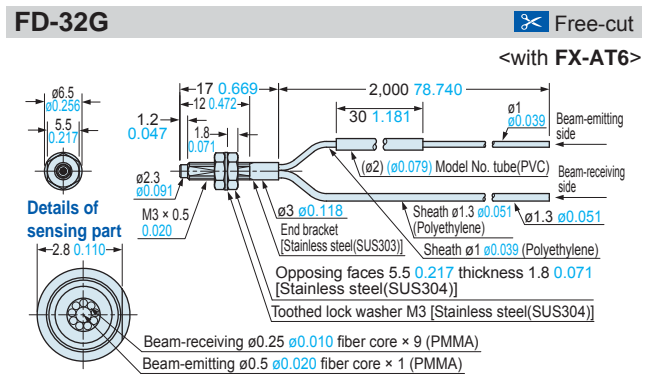
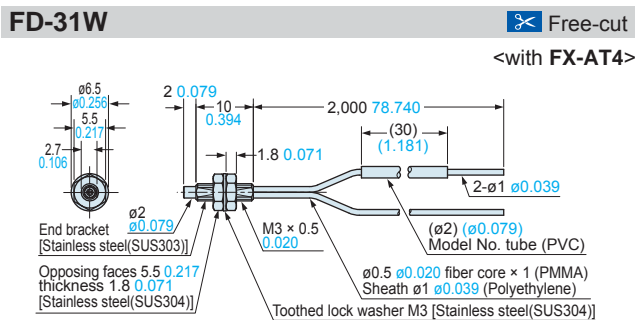
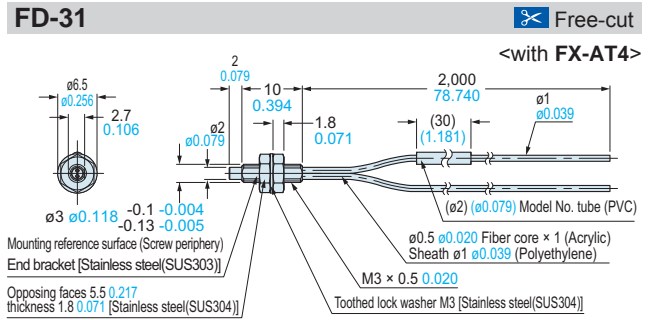
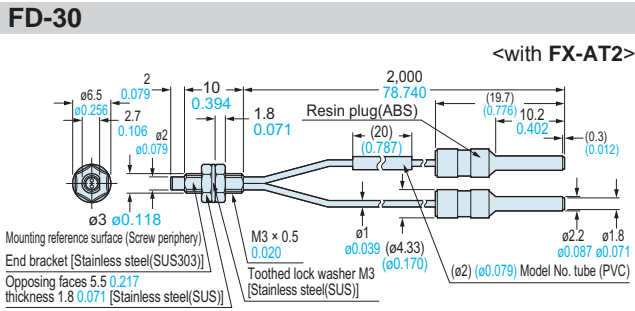

DIMENSIONS (Unit: mm in) Refer to the FX-500 series (p.64), FX-100 series (p.74) for dimensions of the amplifiers. The CAD data in the dimensions can be downloaded from our website.

Reflective type fibers 

Dimensions are listed in the order of thru-beam type, retroreflective type, and reflective type, and in alphabetic order of the model No.

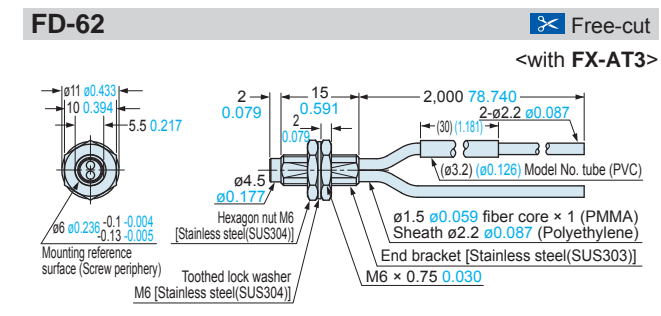
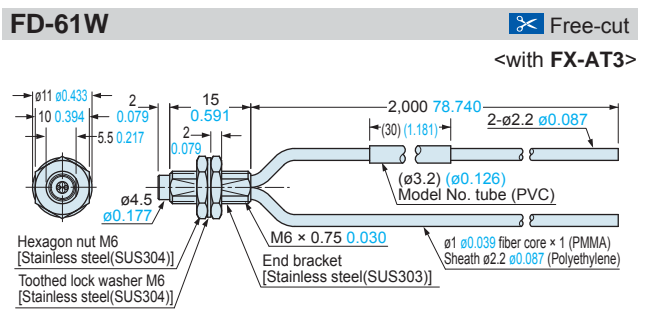
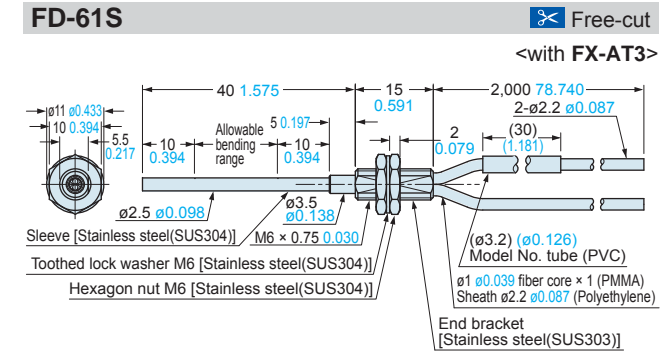
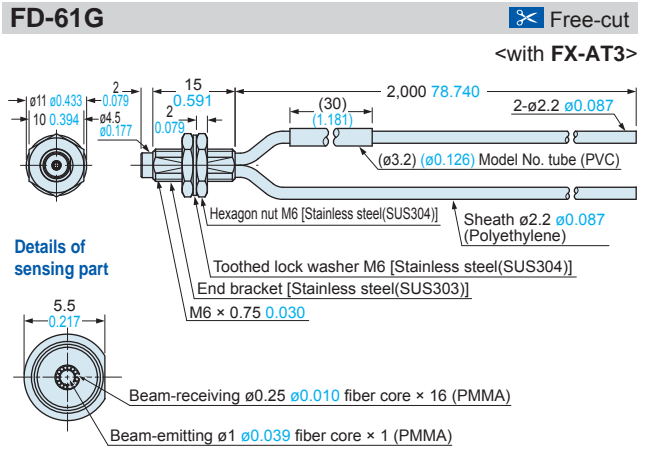
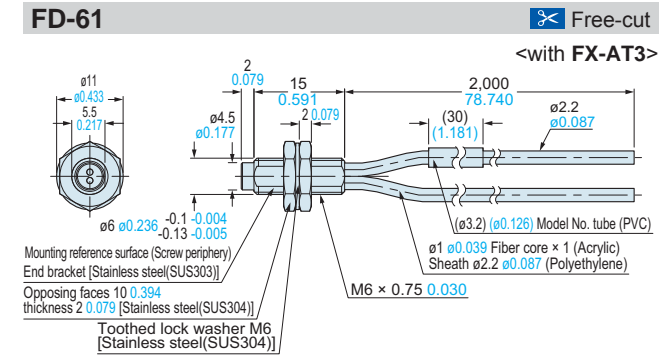
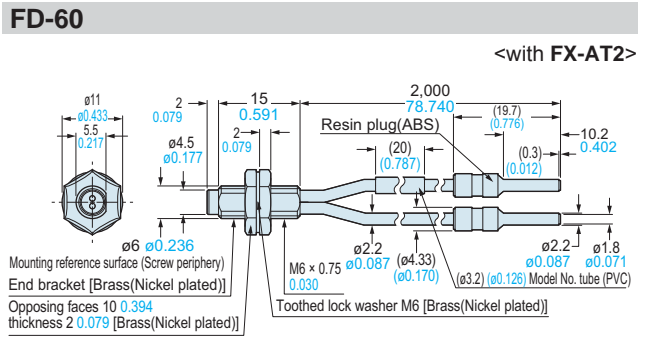
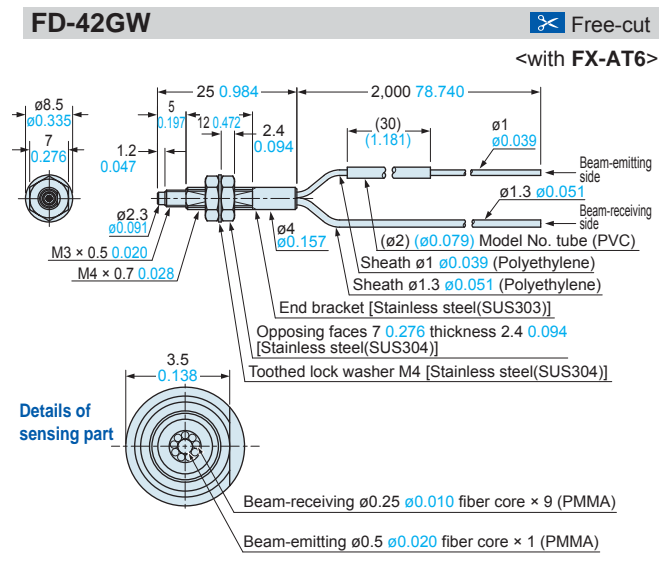
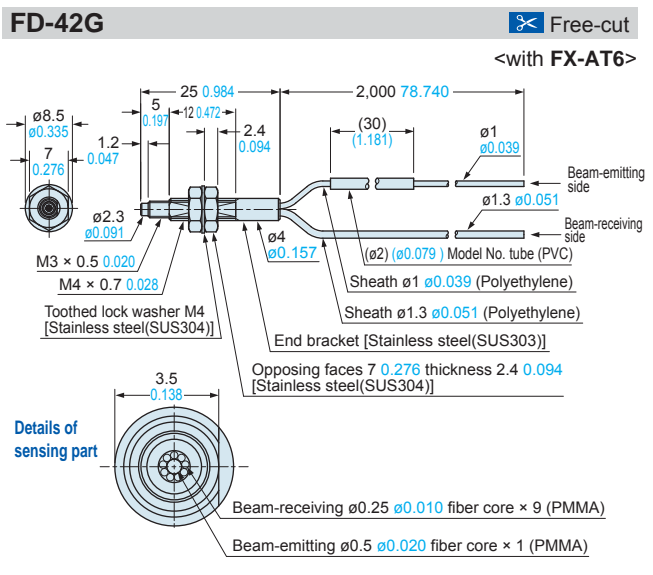

New product introduction

Tough Fiber

Fiber Selection Guide
Choose by model
Choose by shape/application
Viewing new models

Fibers
Super Quality
Threaded Type
Cylindrical Type

Sleeve
Flat Type
Small Spot

Narrow Beam
Wide Beam
Convergent Reflective Type
Retroreflective Type
Chemical-resistant
Heat-resistant
Vacuum-resistant
Liquid Leak / Liquid Detection

Fiber Options

Fiber Dimensions
Thru-beam Type
Retroreflective Type
Reflective Type
Others

Amplifiers
FX-500 series
FX-100 series

INDEX

Earlier models comparison table

DIMENSIONS (Unit: mm in)

Refer to the FX-500 series (p.64), FX-100 series (p.74) for dimensions of the amplifiers. The CAD data in the dimensions can be downloaded from our website.

Reflective type fibers



Dimensions are listed in the order of thru-beam type, retroreflective type, and reflective type, and in alphabetic order of the model No.

FD-64X

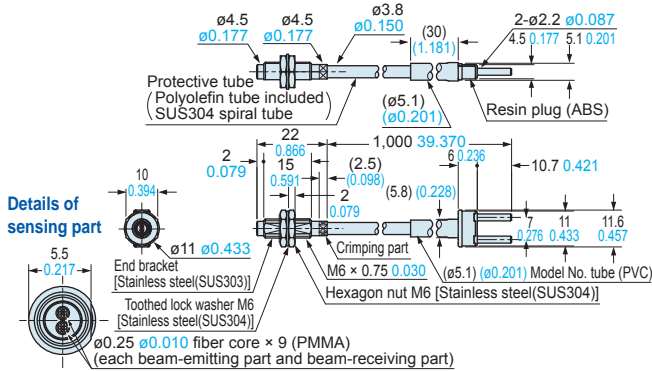

FD-A16

Free-cut

<with FX-AT3>

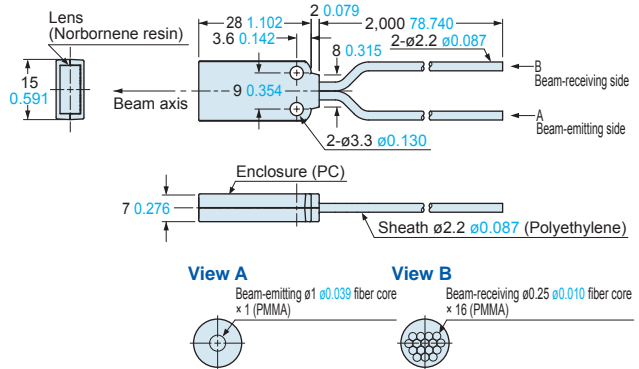

FD-AL11

Free-cut

<with FX-AT3>

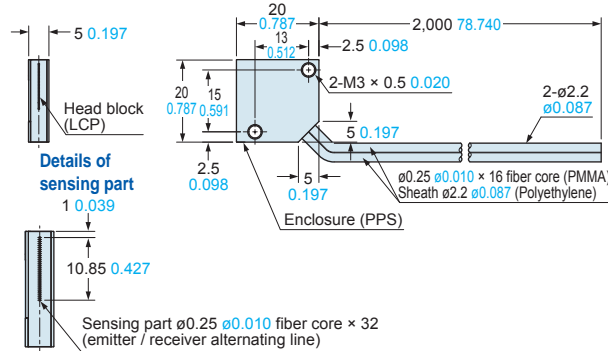

FD-E13

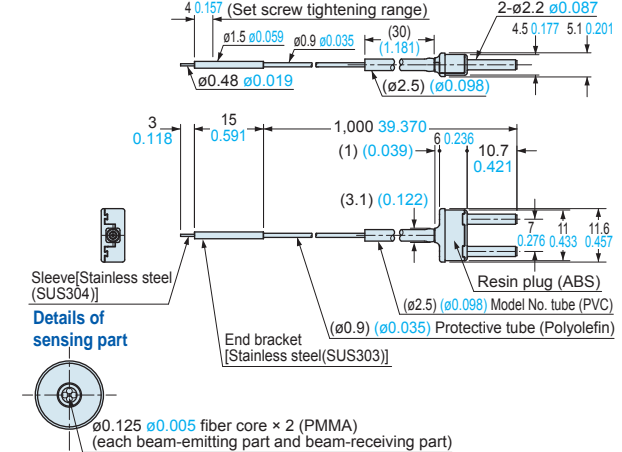

FD-E23

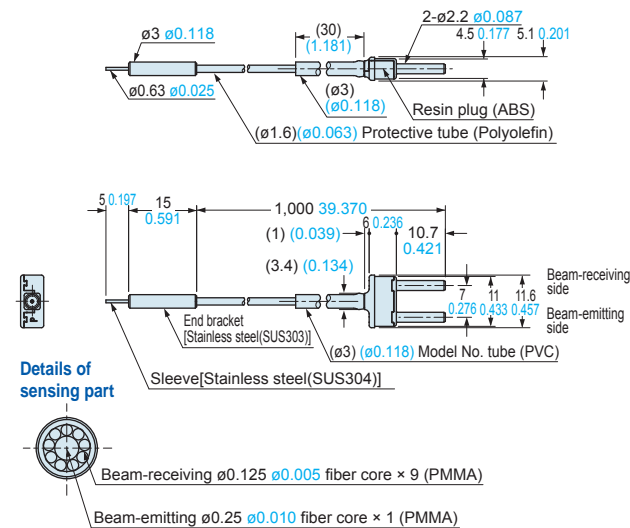

FD-EG30

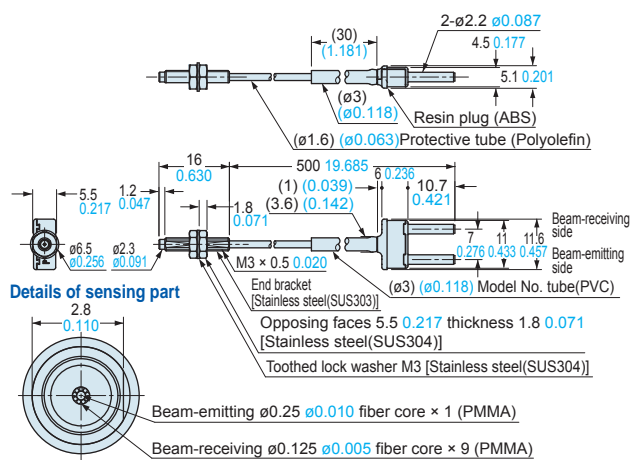

DIMENSIONS (Unit: mm in)

Refer to the FX-500 series (p.64), FX-100 series (p.74) for dimensions of the amplifiers. The CAD data in the dimensions can be downloaded from our website.

Reflective type fibers



Dimensions are listed in the order of thru-beam type, retroreflective type, and reflective type, and in alphabetic order of the model No.

FD-H13-FM2

Free-cut

Details of sensing part

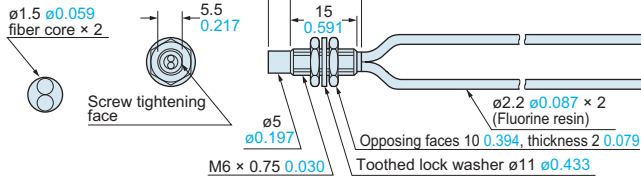

FD-H18-L31

Free-cut

Details of sensing part

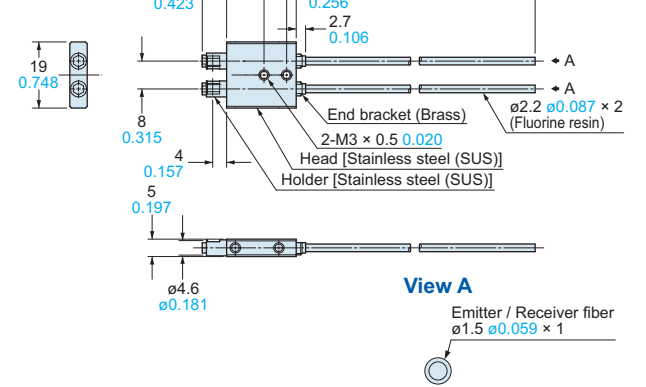

FD-H20-21

Details of sensing part

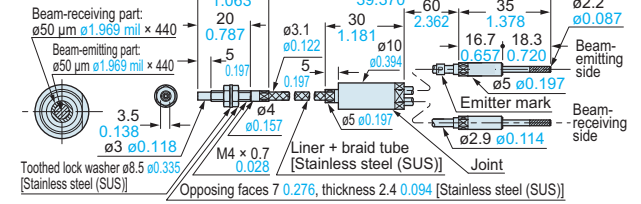

FD-H20-M1

Details of sensing part

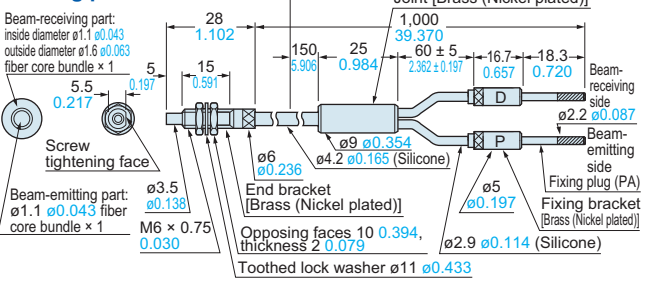

FD-H25-L43

<with FX-AT2>

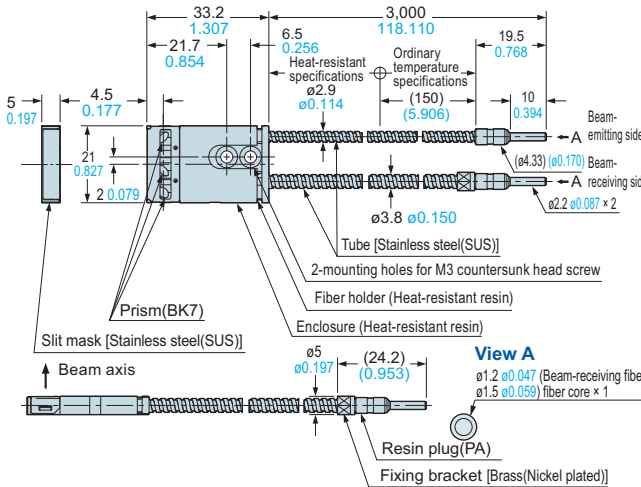

FD-H25-L45

<with FX-AT2>

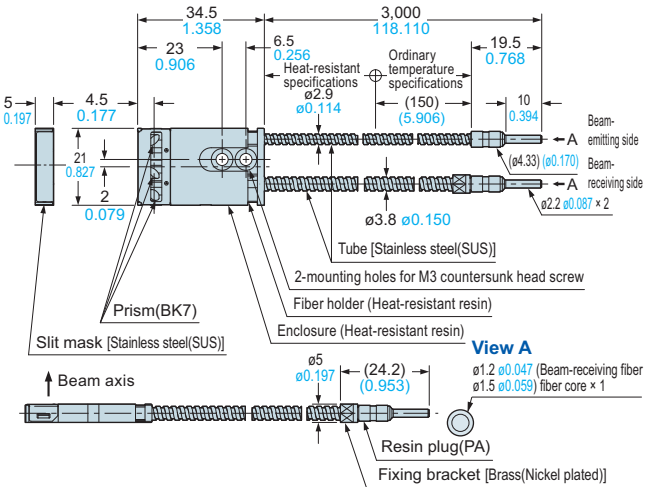

DIMENSIONS (Unit: mm in)

Refer to the **FX-500 series** (p.64), **FX-100 series** (p.74) for dimensions of the amplifiers. The CAD data in the dimensions can be downloaded from our website.

Reflective type fibers



Dimensions are listed in the order of thru-beam type, retroreflective type, and reflective type, and in alphabetic order of the model No.

FD-H30-KZ1V-S

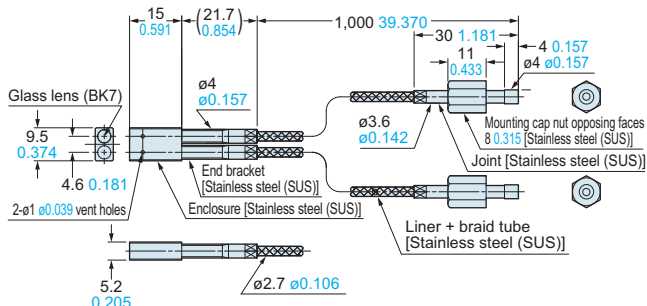

Assembly dimensions with MS-FD-2 (attached mounting bracket)

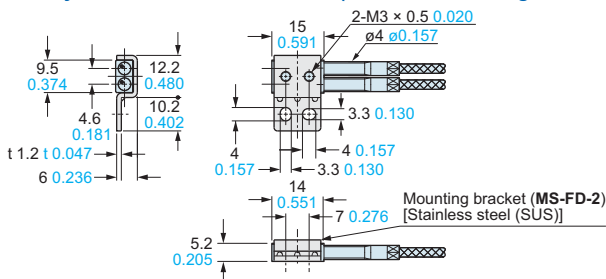

Note: The **FD-H30-KZ1V-S** is a set with the **FD-H30-KZ1V**, photo-terminal **FV-BR1**, and atmospheric side fiber **FT-J8**. Refer to p.51 for dimensions of the atmospheric side fiber and photo-terminals.

FD-H30-L32

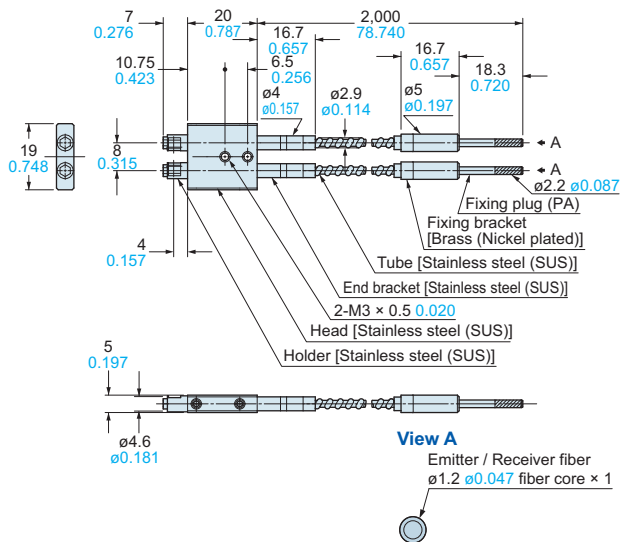

FD-H30-L32V-S

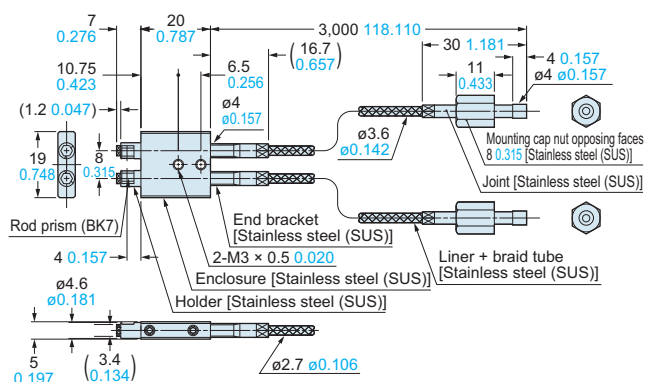

Note: The **FD-H30-L32V-S** is a set with the **FD-H30-L32V**, photo-terminal **FV-BR1**, and atmospheric side fiber **FT-J8**. Refer to p.51 for dimensions of the atmospheric side fiber and photo-terminals.

FD-H35-20S

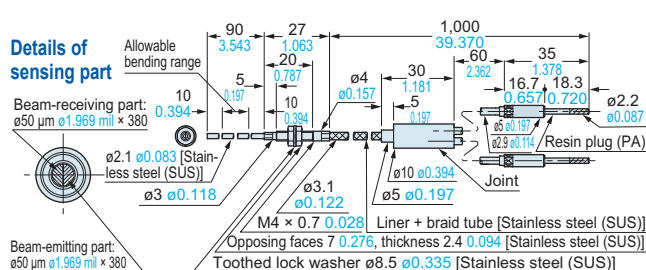

FD-H35-M2

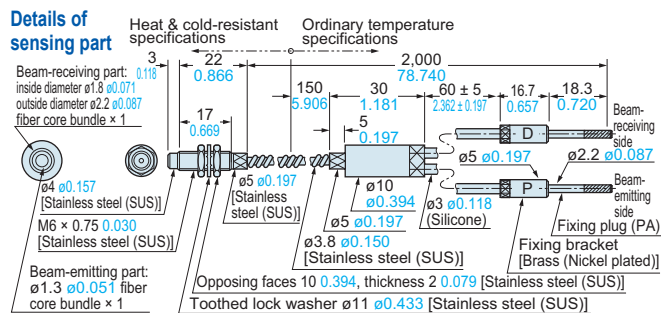

FD-H35-M2S6

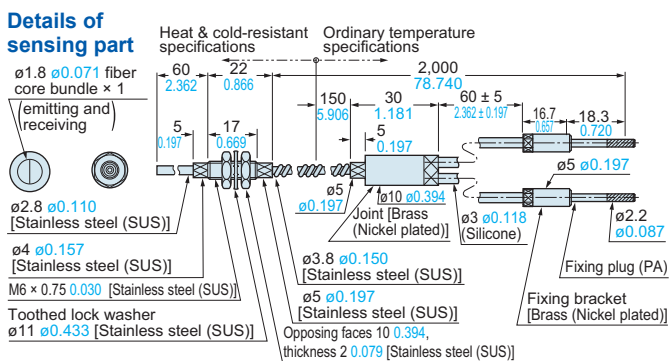

FD-HF40Y

Free-cut
<with FX-AT4>

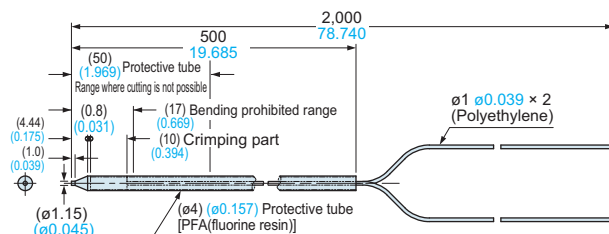

New product introduction
Tough Fiber

Fiber Selection Guide
Choose by model
Choose by shape/application
Viewing new models

Fibers
Super Quality
Threaded Type
Cylindrical Type
Sleeve
Flat Type
Small Spot
Narrow Beam
Wide Beam

Chemical-resistant
Heat-resistant
Vacuum-resistant
Liquid Leak / Liquid Detection

Fiber Options

Fiber Dimensions
Thru-beam Type
Retroreflective Type
Reflective Type
Others

Amplifiers
FX-500 series
FX-100 series

INDEX

Earlier models comparison table

DIMENSIONS (Unit: mm in) Refer to the FX-500 series (p.64), FX-100 series (p.74) for dimensions of the amplifiers. The CAD data in the dimensions can be downloaded from our website.

Reflective type fibers 

Dimensions are listed in the order of thru-beam type, retroreflective type, and reflective type, and in alphabetic order of the model No.

FD-L32H  Free-cut

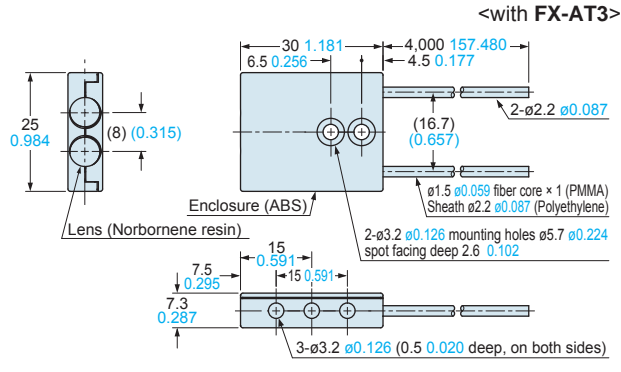

FD-R60  Free-cut

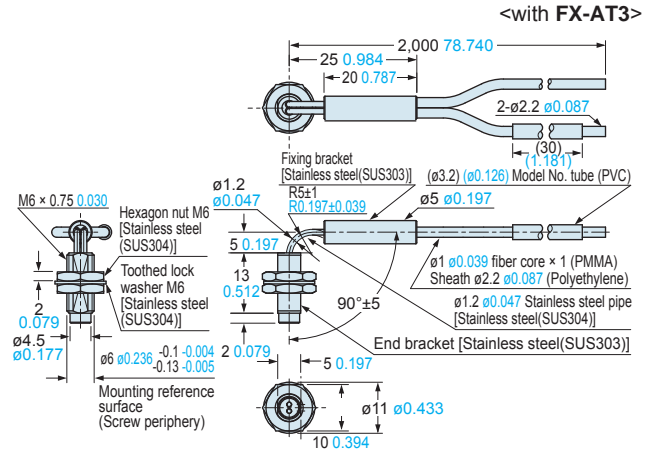

FD-S21

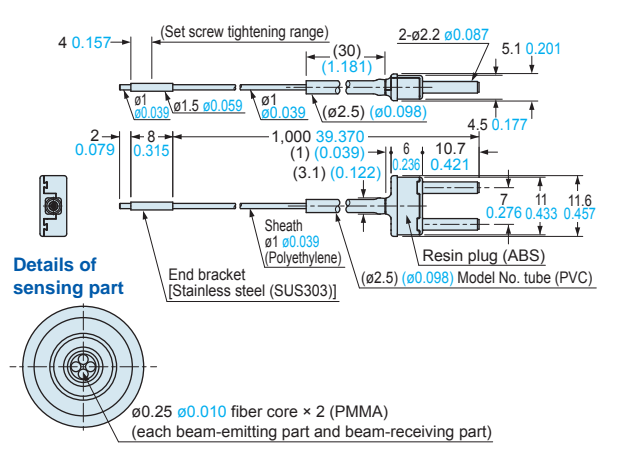

FD-S30 **<with FX-AT2>**

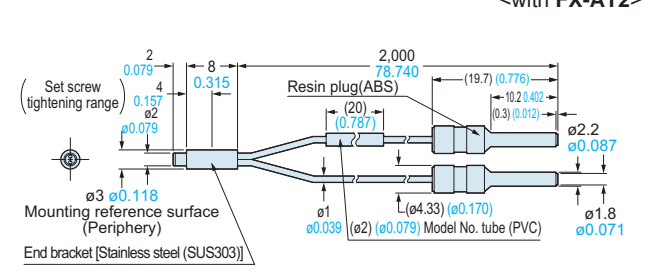

FD-S31  Free-cut **<with FX-AT4>**

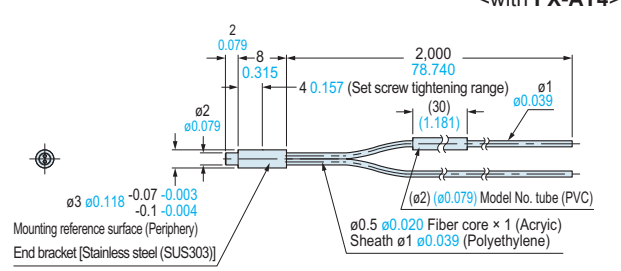

FD-S32  Free-cut **<with FX-AT5>**

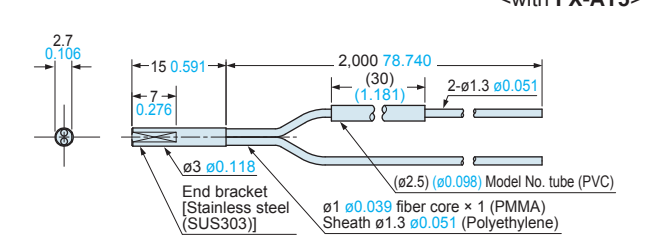

FD-S32W  Free-cut **<with FX-AT5>**

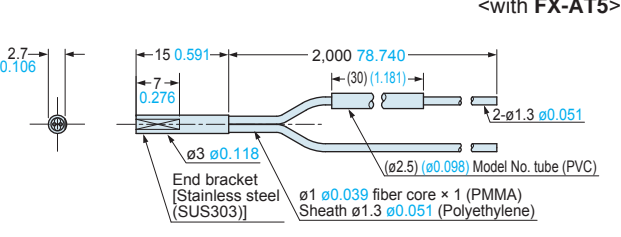

FD-S33GW  Free-cut **<with FX-AT6>**

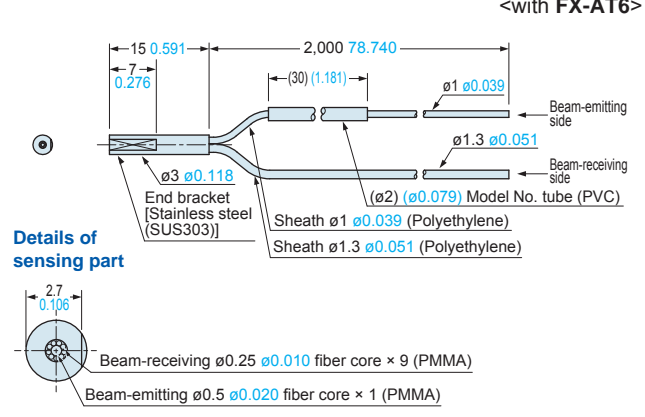

New product introduction
Tough Fiber

Fiber Selection Guide
Choose by model
Choose by shape/application
Viewing new models

Fibers
Super Quality
Threaded Type
Cylindrical Type
Sleeve
Flat Type
Small Spot
Narrow Beam
Wide Beam
Convergent Reflective Type
Retroreflective Type
Chemical-resistant
Heat-resistant
Vacuum-resistant
Liquid Leak / Liquid Detection

Fiber Options

Fiber Dimensions
Thru-beam Type
Retroreflective Type
Reflective Type
Others

Amplifiers
FX-500 series
FX-100 series

INDEX

Earlier models comparison table

DIMENSIONS (Unit: mm in)

Refer to the **FX-500 series** (p.64), **FX-100 series** (p.74) for dimensions of the amplifiers. The CAD data in the dimensions can be downloaded from our website.

Reflective type fibers



Dimensions are listed in the order of thru-beam type, retroreflective type, and reflective type, and in alphabetic order of the model No.

FD-V30

Free-cut

<with FX-AT4>

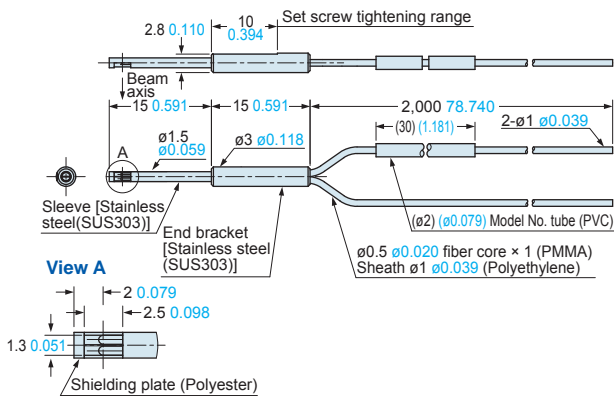

FD-V30W

Free-cut

<with FX-AT4>

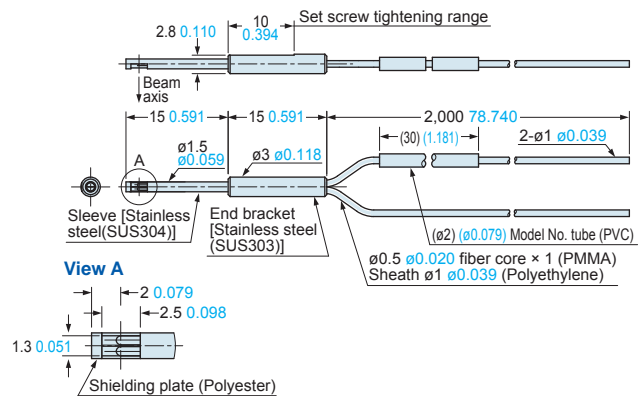

FD-V50

Free-cut

<with FX-AT3>

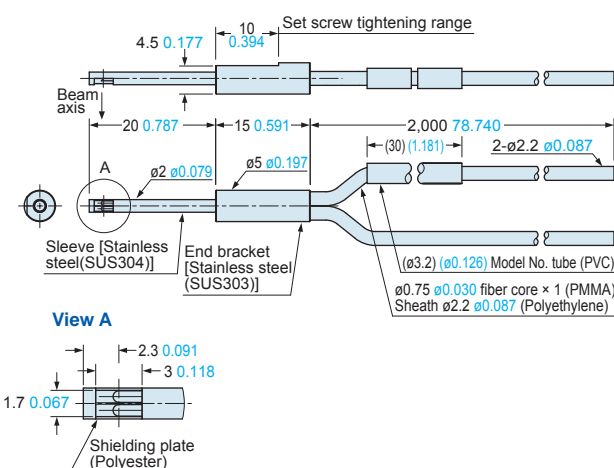

FD-WZ4

Free-cut

<with FX-AT4>

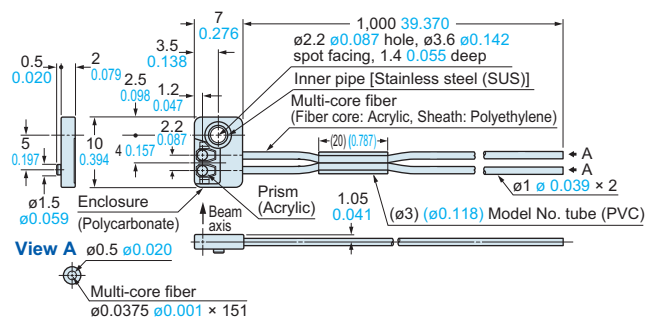

FD-Z20HBW

Free-cut

<with FX-AT4>

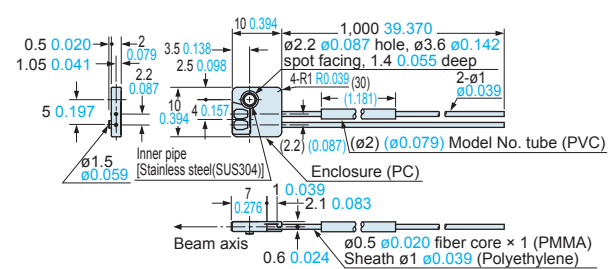

FD-Z40HBW

Free-cut

<with FX-AT5>

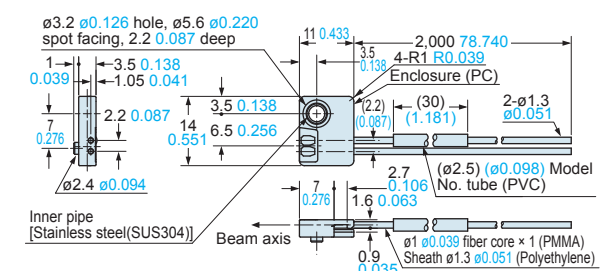

FD-WZ7

Free-cut

<with FX-AT5>

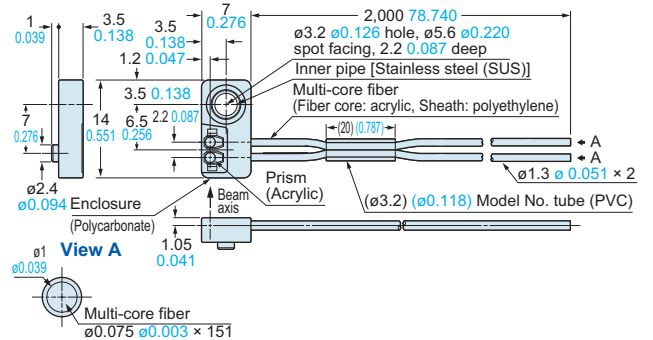

FD-Z50HW

Free-cut

<with FX-AT3>

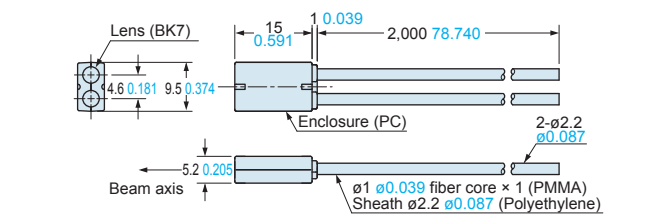

Assembly dimensions with MS-FD-2 (attached mounting bracket)

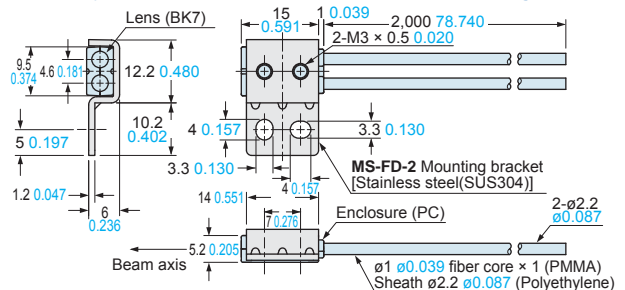

DIMENSIONS (Unit: mm in)

Refer to the FX-500 series (p.64), FX-100 series (p.74) for dimensions of the amplifiers.
The CAD data in the dimensions can be downloaded from our website.

Vacuum-resistant Atmospheric side fiber

FT-J8 Free-cut

(Accessory for vacuum-resistant fiber) <with FX-AT3>

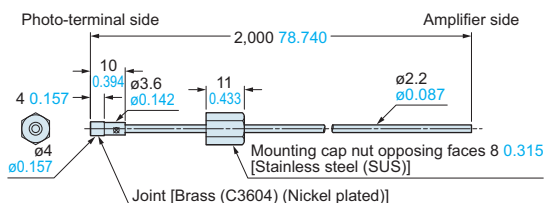

FB-1 Fiber bender (Optional)

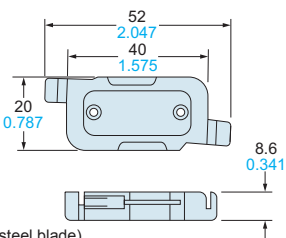

Material: PP (Containing steel blade)

FV-BR1 Photo-terminal (for vacuum-resistant) (with vacuum-resistant fiber)

Mounting hole

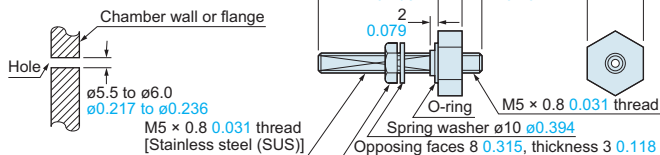

FV-LE1 Vacuum-resistant expansion lens (Optional)

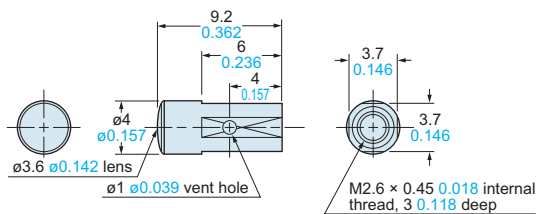

Material: Enclosure..... Aluminum alloy (A6061-T6)
Lens.....BK-7

FV-SV2 Vacuum-resistant side-view lens (Optional)

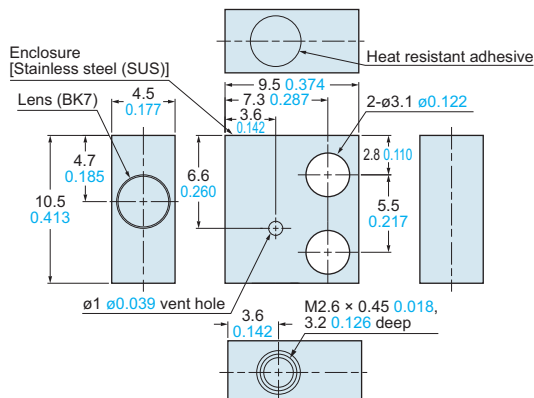

FTP-□ FDP-□ Protective tube (Optional)

FTP-□, FDP-N□

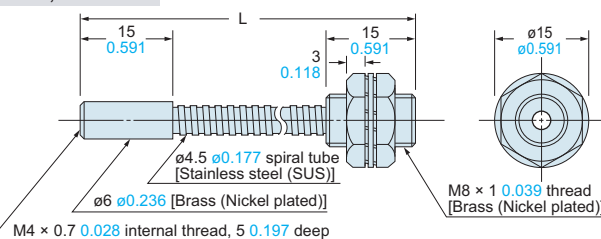

FTP-N□

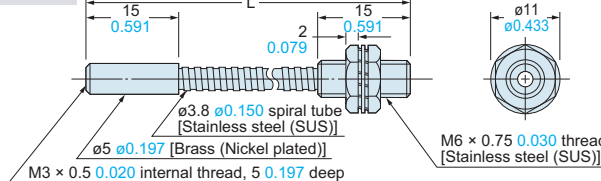

FDP-□

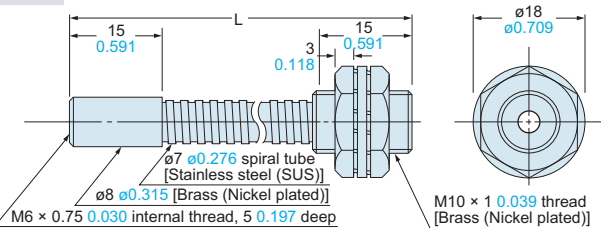

• Length L

Model No.	Length L
FTP-500, FTP-N500, FDP-N500, FDP-500	500 ⁺¹⁰ ₀ 19.685 ^{+0.394} ₀
FTP-1000, FTP-N1000, FDP-N1000, FDP-1000	1,000 ⁺¹⁰ ₀ 39.370 ^{+0.394} ₀
FTP-1500, FTP-N1500, FDP-N1500, FDP-1500	1,500 ⁺¹⁰ ₀ 59.055 ^{+0.394} ₀

New product introduction
Tough Fiber
Fiber Selection Guide
Choose by model
Choose by shape/application
Viewing new models

Fibers
Super Quality
Threaded Type
Cylindrical Type
Sleeve
Flat Type
Small Spot
Narrow Beam
Wide Beam
Convergent Reflective Type
Retroreflective Type
Chemical-resistant
Heat-resistant
Vacuum-resistant
Liquid Leak / Liquid Detection

Fiber Options
Fiber Dimensions
Thru-beam Type
Retroreflective Type
Reflective Type

Others

Amplifiers
FX-500 series
FX-100 series

INDEX

Earlier models comparison table

DIMENSIONS (Unit: mm in)

Refer to the **FX-500** series (p.64), **FX-100** series (p.74) for dimensions of the amplifiers. The CAD data in the dimensions can be downloaded from our website.

FX-AT2 Attachment for fixed-length fiber (Accessory for fixed-length fiber)

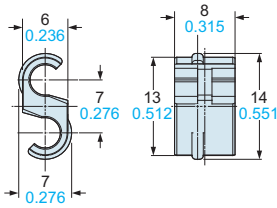

Material: POM

FX-AT3 Attachment for $\varnothing 2.2$ mm $\varnothing 0.087$ in fiber (Accessory for $\varnothing 2.2$ mm $\varnothing 0.087$ in fiber)

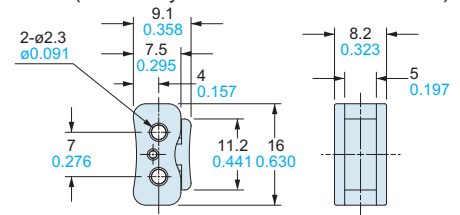

Material: Polycarbonate

FX-AT4 Attachment for $\varnothing 1$ mm $\varnothing 0.039$ in fiber (Accessory for $\varnothing 1$ mm $\varnothing 0.039$ in fiber)

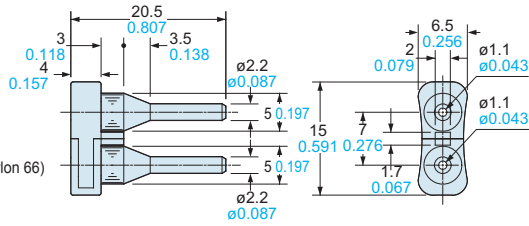

Material: Holder...PA (Nylon 66)
Ground...POM

FX-AT5 Attachment for $\varnothing 1.3$ mm $\varnothing 0.051$ in fiber (Accessory for $\varnothing 1.3$ mm $\varnothing 0.051$ in fiber)

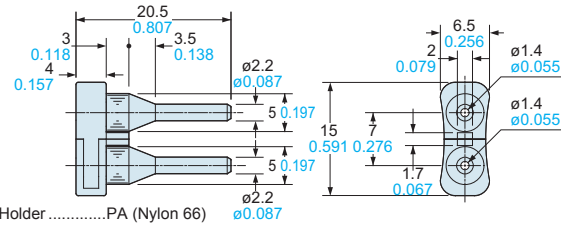

Material: Holder.....PA (Nylon 66)
Ground.....POM

FX-AT6 Attachment for $\varnothing 1$ mm $\varnothing 0.039$ in / $\varnothing 1.3$ mm $\varnothing 0.051$ in mixed fiber (Accessory for $\varnothing 1$ mm $\varnothing 0.039$ in / $\varnothing 1.3$ mm $\varnothing 0.051$ in mixed fiber)

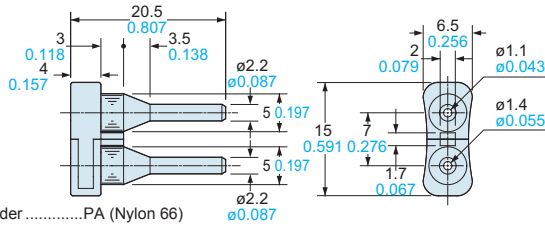

Material: Holder.....PA (Nylon 66)
Ground.....POM

FX-CT2 Fiber cutter (Accessory for free-cut type fiber)

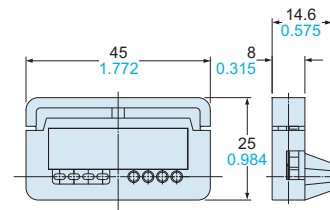

Material: ABS

FX-LE1 Expansion lens (Optional)

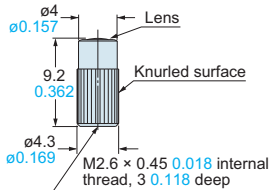

Material: Enclosure.....Brass (Nickel plated)
Lens.....Glass

FX-LE2 Super-expansion lens (Optional)

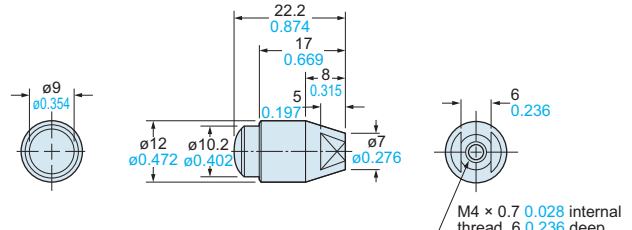

Material: Enclosure.....Stainless steel (SUS303)
Lens.....Glass

FX-MR1 Pinpoint spot lens (Optional)

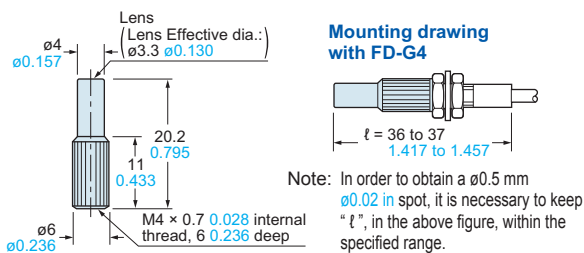

Note: In order to obtain a $\varnothing 0.5$ mm $\varnothing 0.02$ in spot, it is necessary to keep "l", in the above figure, within the specified range.

Material: Enclosure.....Aluminum (Black ALMITE)
Lens.....Glass

FX-MR2 Zoom lens (Optional)

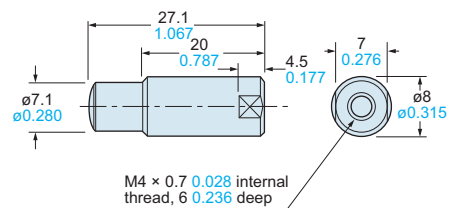

Material: Enclosure.....Aluminum (Black ALMITE)
Lens.....Glass

New product introduction
Tough Fiber
Fiber Selection Guide
Choose by model
Choose by shape/application
Viewing new models

Fibers
Super Quality
Threaded Type
Cylindrical Type
Sleeve
Flat Type
Small Spot
Narrow Beam
Wide Beam
Convergent Reflective Type
Retroreflective Type
Chemical-resistant
Heat-resistant
Vacuum-resistant
Liquid Leak/Liquid Detection

Fiber Options
Fiber Dimensions
Thru-beam Type
Retroreflective Type
Reflective Type
Others

Amplifiers
FX-500 series
FX-100 series

INDEX

Earlier models comparison table

DIMENSIONS (Unit: mm in) Refer to the **FX-500 series (p.64)**, **FX-100 series (p.74)** for dimensions of the amplifiers. The CAD data in the dimensions can be downloaded from our website.

FX-MR3 Finest spot lens (Optional)

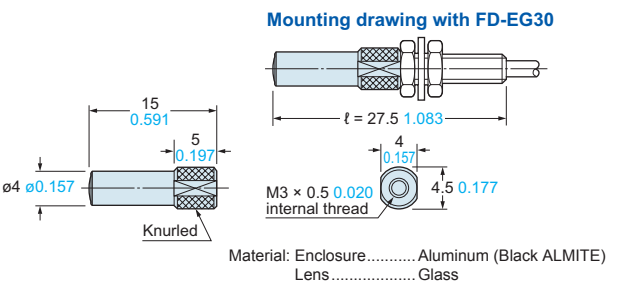

Note: When inserting the fiber, insert fully till it stops.

FX-MR5 Zoom lens (Optional)

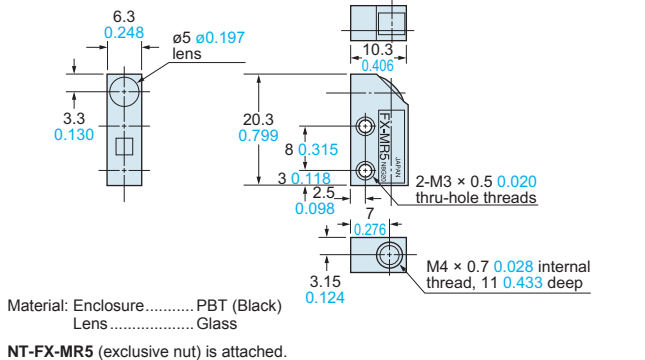

FX-MR6 Finest spot lens (Optional)

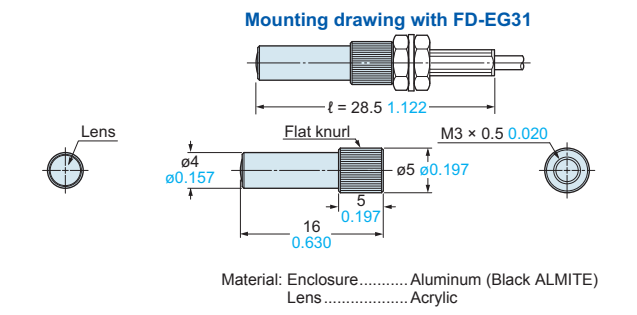

Note: When inserting the fiber, insert fully till it stops.

FX-SV1 Side-view lens (Optional)

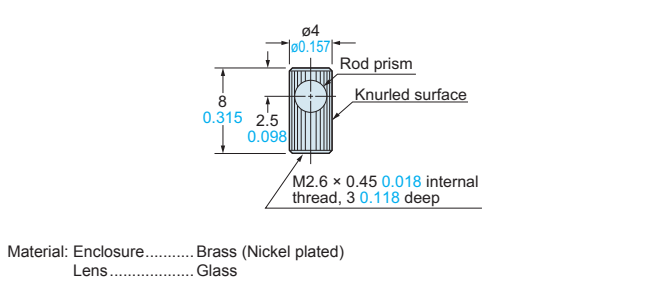

MS-EX3 Mounting bracket for FX-MR2 (Accessory for FX-MR2)

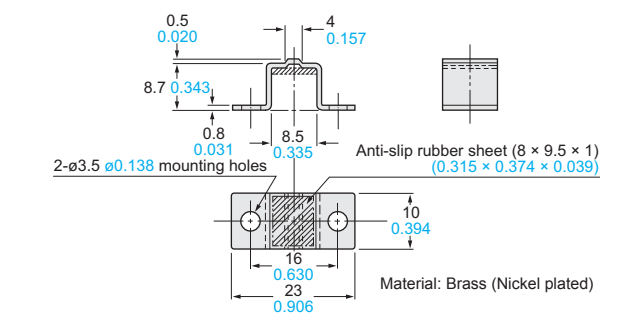

MS-FD-2 Fiber mounting bracket

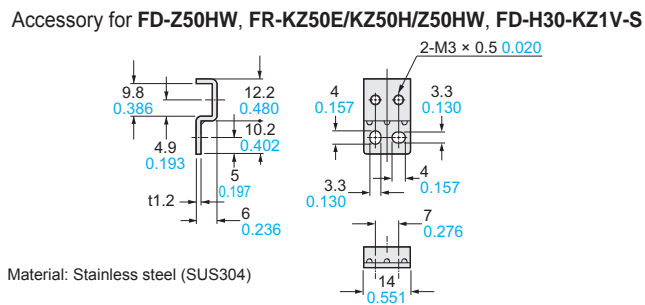

MS-FD-3 Fiber mounting bracket

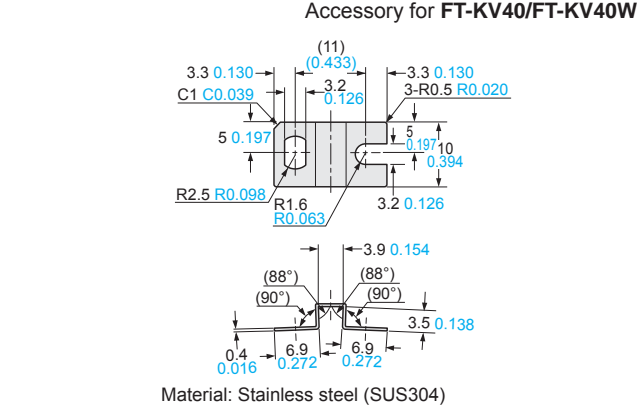

RF-003 Reflector for FR-KZ50E/KZ50H

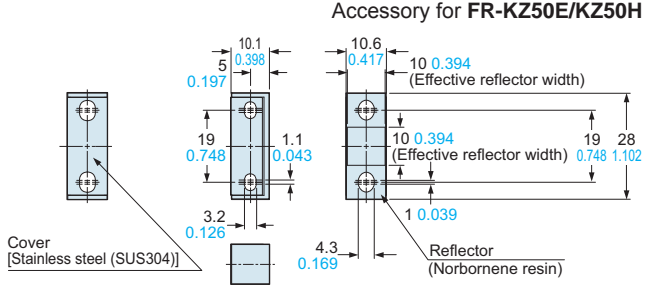

New product introduction

Tough Fiber

Fiber Selection Guide

Choose by model

Choose by shape/application

Viewing new models

Fibers

Super Quality

Threaded Type

Cylindrical Type

Sleeve

Flat Type

Small Spot

Narrow Beam

Wide Beam

Convergent Reflective Type

Retroreflective Type

Chemical-resistant

Heat-resistant

Vacuum-resistant

Liquid Leak / Liquid Detection

Fiber Options

Fiber Dimensions

Thru-beam Type

Retroreflective Type

Reflective Type

Others

Amplifiers

FX-500 series

FX-100 series

INDEX

Earlier models comparison table

DIMENSIONS (Unit: mm in)

Refer to the **FX-500** series (p.64), **FX-100** series (p.74) for dimensions of the amplifiers. The CAD data in the dimensions can be downloaded from our website.

New product introduction
Tough Fiber

Fiber Selection Guide
Choose by model
Choose by shape/application
Viewing new models

Fibers
Super Quality
Threaded Type
Cylindrical Type

Sleeve
Flat Type
Small Spot
Narrow Beam
Wide Beam
Convergent Reflective Type
Retroreflective Type
Chemical-resistant
Heat-resistant
Vacuum-resistant
Liquid Leak/Liquid Detection

Fiber Options

Fiber Dimensions
Thru-beam Type
Retroreflective Type
Reflective Type

Others

Amplifiers
FX-500 series
FX-100 series

INDEX

Earlier models comparison table

RF-210 Reflector (Optional)

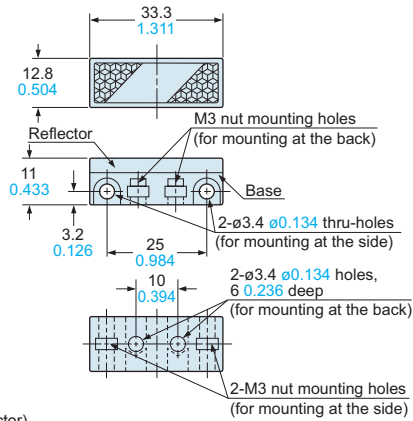

Material: Acrylic (Reflector)
ABS (Base)

Two M3 (length 8 mm 0.315 in) screws with washers and two nuts are attached.

RF-220 Reflector (Optional)

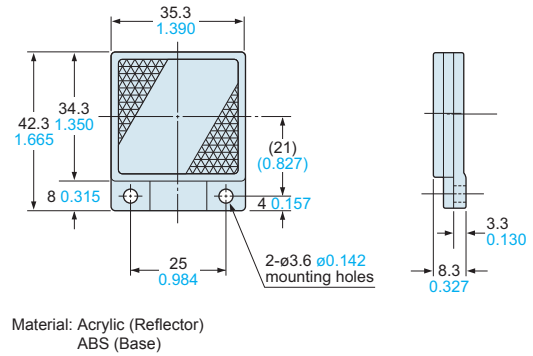

Material: Acrylic (Reflector)
ABS (Base)

RF-230 Reflector (Optional)

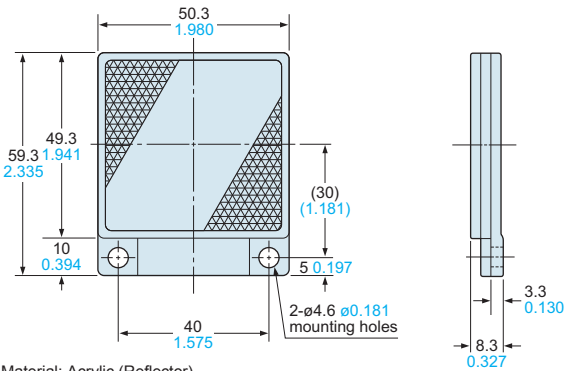

Material: Acrylic (Reflector)
ABS (Base)

MEMO

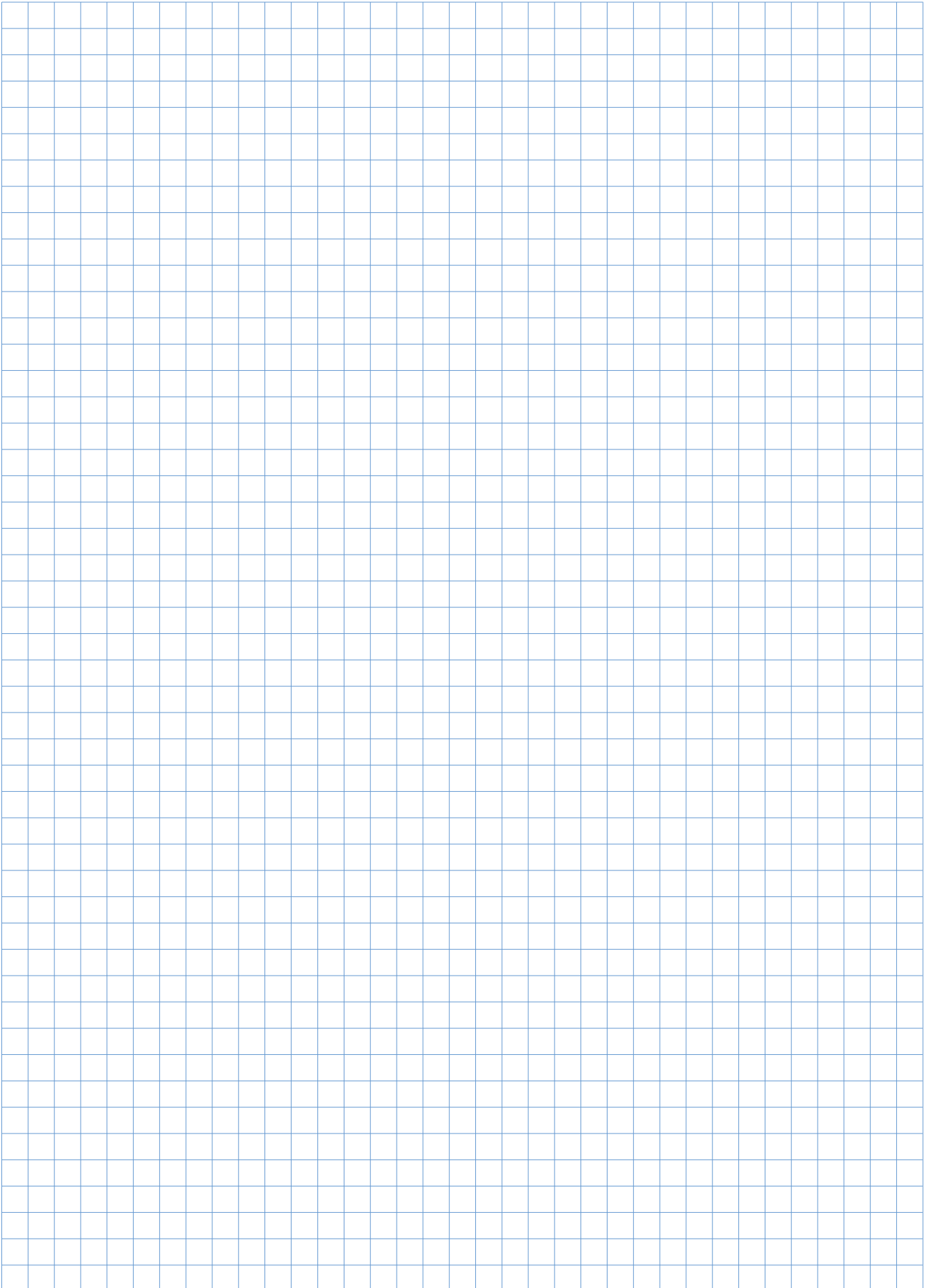

Digital Fiber Sensor FX-500 SERIES

◆ At the industry's leading edge

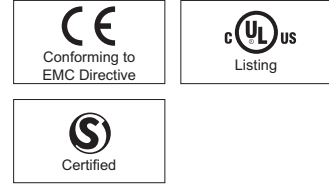

High stability! Decrease the variation among fiber sensors

When the FX-500 series is used together with our super quality fiber, the incident light intensity variation among units is decreased to only 1/4 of that of conventional models. By being close to absolute values instead of modified digital values, changes in detection that could not be found in the past can now be monitored.

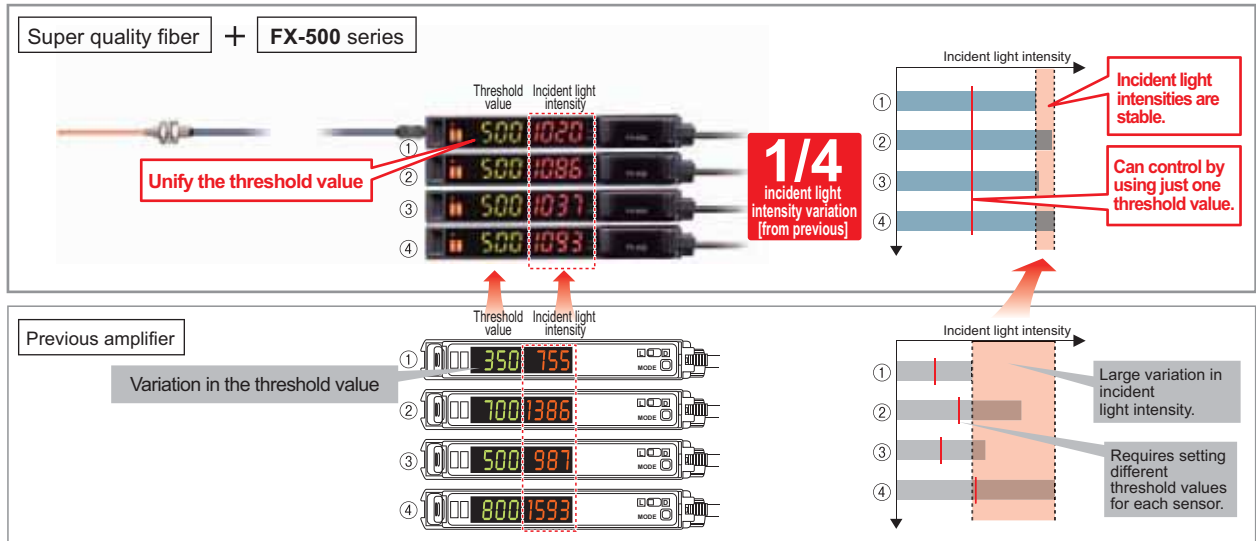

Max. 25 μs response time

Performing minute object detection when using a small diameter fiber is now possible with a high response time and longer sensing range.



Hyper HYPR mode incorporated

FX-500 in combination with small diameter fibers which can handle challenging detections, allows super long sensing range.



Note: When using FD-NFM2.

- New product introduction
- Tough Fiber
- Fiber Selection Guide
- Choose by model
- Choose by shape/application
- Viewing new models
- Fibers
- Super Quality
- Threaded Type
- Cylindrical Type
- Sleeve
- Flat Type
- Small Spot
- Narroe Beam
- Wide Beam
- Convergent Reflective Type
- Retroreflective Type
- Chemical-resistant
- Heat-resistant
- Vacuum-resistant
- Liquid Leak / Liquid Detection
- Fiber Options
- Fiber Dimensions
- Thru-beam Type
- Retroreflective Type
- Reflective Type
- Others
- Amplifiers
- FX-500 series
- FX-100 series
- INDEX
- Earlier models comparison table

A different accuracy! Sharp detection with suppressed hysteresis

FX-500 with its accurate detection catches fractional difference in light intensity, fulfilling high precision and low-hysteresis applications.

- Long range detection of small objects with small difference in light intensity **H-02 mode**
- Highly accurate detection while avoiding saturation **H-01 mode**

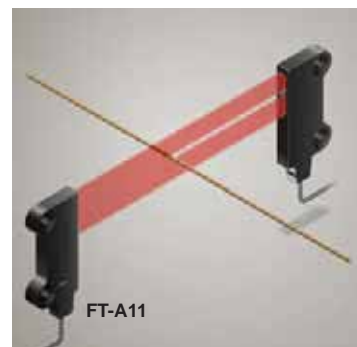
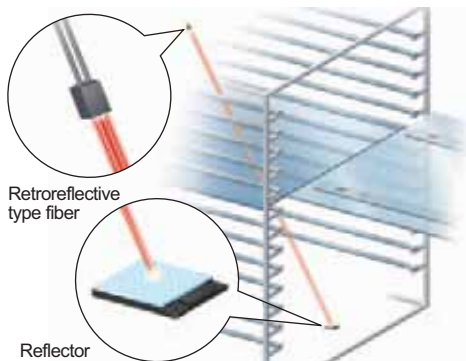

Incident light intensity to a comprehensible value (Display adjustment setting)

The display can be corrected to show any value using the display adjustment settings. It is effective in using multiple units with the same condition.

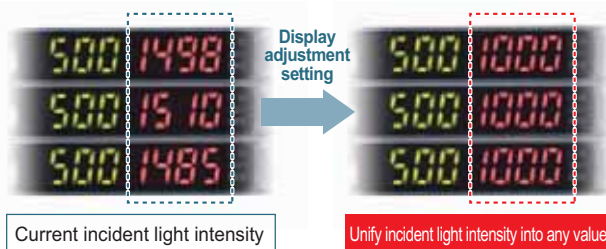

Built-in logic functions No PLC necessary saving material and programming costs

Logical calculation functions

Three logical calculations (AND, OR, XOR), are selectable using Output 1 of multiple **FX-500** series amplifiers. A PLC is not required which helps to reduce material and programming and costs.

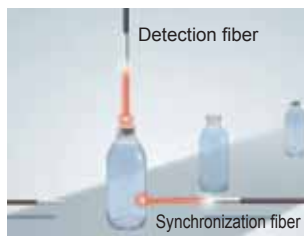

Calculation of two neighboring amplifiers

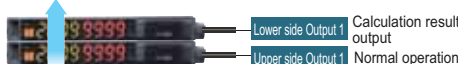

Communication direction (Up to 12 units)

Calculation of two outputs in one amplifier **FX-502(P) / 505(P)-C2**



Calculation of one amplifier and external input **FX-502(P) / 505(P)-C2**



Equipped with 5 types timers

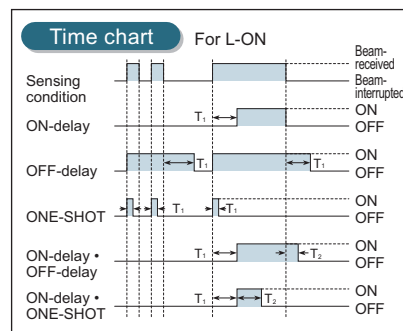

Timer period: 0.05 ms to 32 s
Output 1 has ON-delay • OFF-delay and ON-delay • ONE-SHOT timers.

Smooth setup changes by 8 data banks

Setup conditions can be saved and loaded to make setup changes easy at worksite that manufactures multiple models.

An optical communication function allows sensors to be adjusted simultaneously

The optical communication function allows the data that is currently set to be copied and saved all at once for all amplifiers connected together from the right side.

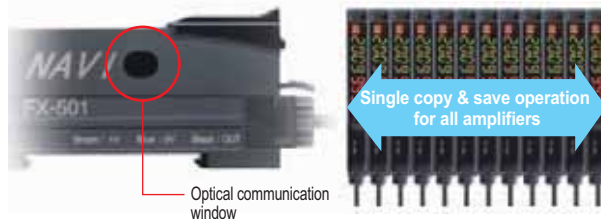

Remote control improves work efficiency by external input **FX-502(P) / FX-505(P)-C2**

Various types of functions, such as teaching and data load/save, can be performed by PLC external signal, using external input*.

* The **FX-502 (P)** switches Output 2 for an external input.

No need to specify a main unit or sub unit

Just use a main cable or a sub cable to distinguish the two. This reduces the costs of inventory management.

New product introduction
Tough Fiber
Fiber Selection Guide
Choose by model
Choose by shape/application
Viewing new models

Fibers
Super Quality
Threaded Type
Cylindrical Type
Sleeve
Flat Type
Small Spot
Narrow Beam
Wide Beam
Convergent Reflective Type
Retroreflective Type
Chemical-resistant
Heat-resistant
Vacuum-resistant
Liquid Leak / Liquid Detection

Fiber Options
Fiber Dimensions
Thru-beam Type
Retroreflective Type
Reflective Type
Others

Amplifiers
FX-500 series
FX-100 series

INDEX

Earlier models comparison table

ORDER GUIDE

New product introduction
Tough Fiber

Fiber Selection Guide
Choose by model
Choose by shape/application
Viewing new models

Fibers
Super Quality
Threaded Type
Cylindrical Type
Sleeve
Flat Type
Small Spot
Narrow Beam
Wide Beam
Convergent Reflective Type
Retroreflective Type
Chemical-resistant
Heat-resistant
Vacuum-resistant
Liquid Leak / Liquid Detection

Fiber Options
Fiber Dimensions
Thru-beam Type
Retroreflective Type
Reflective Type
Others



Amplifiers
FX-500 series
FX-100 series

INDEX

Earlier models comparison table

Amplifiers

Quick-connection cable is not supplied with **FX-501(P)** and **FX-502(P)**. Please order it separately.

Type	Appearance	Model No.	Emitting element	Output	External input
Standard type		FX-501	Red LED	NPN open-collector transistor	—
		FX-501P		PNP open-collector transistor	
2-output type		FX-502		NPN open-collector transistor 2 outputs	Incorporated (Switchable with Output 2)
		FX-502P		PNP open-collector transistor 2 outputs	
Cable type		FX-505-C2		NPN open-collector transistor 2 outputs, analog output	Incorporated
		FX-505P-C2		PNP open-collector transistor 2 outputs, analog output	

Quick-connection cables

For FX-501(P) Quick-connection cable is not supplied with the amplifier. Please order it separately.

Type	Model No.	Description	
Main cable (3-core)	CN-73-C1	Length: 1 m 3.281 ft	0.15 mm ² 3-core cabtyre cable, with connector on one end Cable outer diameter: ø3.0 mm ø 0.118 in
	CN-73-C2	Length: 2 m 6.562 ft	
	CN-73-C5	Length: 5 m 16.404 ft	
Sub cable (1-core)	CN-71-C1	Length: 1 m 3.281 ft	0.15 mm ² 1-core cabtyre cable, with connector on one end Cable outer diameter: ø3.0 mm ø 0.118 in Connectable to a main cable up to 15 cables.
	CN-71-C2	Length: 2 m 6.562 ft	
	CN-71-C5	Length: 5 m 16.404 ft	

Main cable

- **CN-73-C□**

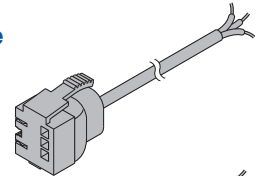

Sub cable

- **CN-71-C□**

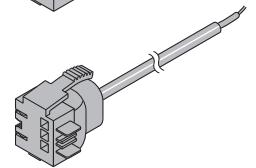

For FX-502(P) Quick-connection cable is not supplied with the amplifier. Please order it separately.

Type	Model No.	Description	
Main cable (4-core)	CN-74-C1	Length: 1 m 3.281 ft	0.15 mm ² 4-core cabtyre cable, with connector on one end Cable outer diameter: ø3.0 mm ø 0.118 in
	CN-74-C2	Length: 2 m 6.562 ft	
	CN-74-C5	Length: 5 m 16.404 ft	
Sub cable (2-core)	CN-72-C1	Length: 1 m 3.281 ft	0.15 mm ² 2-core cabtyre cable, with connector on one end Cable outer diameter: ø3.0 mm ø 0.118 in Connectable to a main cable up to 15 cables.
	CN-72-C2	Length: 2 m 6.562 ft	
	CN-72-C5	Length: 5 m 16.404 ft	

Main cable

- **CN-74-C□**

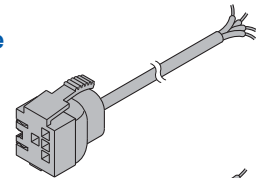

Sub cable

- **CN-72-C□**

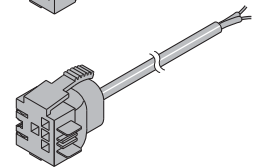

End plates

End plates are not supplied with the amplifier. Please order them separately when the amplifiers are mounted in cascade.

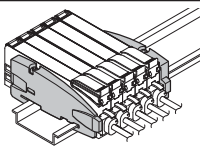
Appearance	Model No.	Description
	MS-DIN-E	When cascading multiple amplifiers, or when it moves depending on the way it is installed on a DIN rail, these end plates clamp amplifiers into place on both sides. Make sure to use end plates when cascading multiple amplifiers together. Two pcs. per set

OPTIONS

Designation	Model No.	Description
Amplifier mounting bracket	MS-DIN-2	Mounting bracket for amplifier

Accessory

- **FX-MB1** (Amplifier protection seal)
10 sets of 2 communication window seals and 1 connector seal

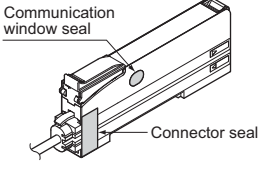

Amplifier mounting bracket

- **MS-DIN-2**

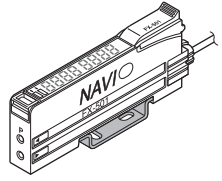

New product introduction

Tough Fiber

Fiber Selection Guide

Choose by model

Choose by shape/application

Viewing new models

Fibers

Super Quality

Threaded Type

Cylindrical Type

Sleeve

Flat Type

Small Spot

Narrow Beam

Wide Beam

Convergent Reflective Type

Retroreflective Type

Chemical-resistant

Heat-resistant

Vacuum-resistant

Liquid Leak / Liquid Detection

Fiber Options

Fiber Dimensions

Thru-beam Type

Retroreflective Type

Reflective Type

Others

Amplifiers

FX-500 series

FX-100 series

INDEX

Earlier models comparison table

SPECIFICATIONS

Item	Model No.	Type	Standard type	2-output type	Cable type (Analog output type)
		NPN output	FX-501	FX-502	FX-505-C2
		PNP output	FX-501P	FX-502P	FX-505P-C2
Supply voltage	12 to 24 V DC ⁺¹⁰ / ₋₁₅ % Ripple P-P 10 % or less				
Power consumption	Normal operation: 960 mW or less (current consumption 40 mA or less at 24 V supply voltage, excluding analog output of cable type) ECO mode: 680 mW or less (current consumption 28 mA or less at 24 V supply voltage, excluding analog output of cable type)				
Output (2-output type and cable type: Output 1, Output 2)	<NPN output type> NPN open-collector transistor		<PNP output type> PNP open-collector transistor		
	<ul style="list-style-type: none"> Maximum sink current: 100 mA (2-output type and cable type are 50 mA) (Note 2) Applied voltage: 30 V DC or less (between output and 0 V) Residual voltage: 2 V or less (Note 3) (at maximum sink current) 		<ul style="list-style-type: none"> Maximum source current: 100 mA (2-output type and cable type are 50 mA) (Note 2) Applied voltage: 30 V DC or less (between output and +V) Residual voltage: 2 V or less (Note 3) (at maximum source current) 		
	Output points	1 point	2 points		
	Output operation	Switchable either Light-ON or Dark-ON by L/D mode			
Short-circuit protection	Incorporated				
Response time	H-SP: 25 μs or less, FAST: 60 μs or less, STD: 250 μs or less, LONG: 2 ms or less, U-LG: 4 ms or less, HYPR: 24 ms or less, selectable				
Analog output (Cable type only)	Output current: 4 to 20 mA approx. [H-SP, FAST STD: At 0 to 4,000 digits, LONG: At 0 to 8,000 digits (Note 4)], Response time: 2 ms or less, Zero point: Within 4 mA ±1 % F.S., Span: Within 16 mA ±5 % F.S., Linearity: Within ±3 % F.S., Load resistance: 0 to 250 Ω				
External input (2-output type only, switchable with Output 2)	————	<NPN output type> NPN non-contact input	<PNP output type> PNP non-contact input		
		<ul style="list-style-type: none"> Signal condition High: +8 V to +V DC or Open Low: 0 to +1.2 V DC (at 0.5 mA source current) Input impedance: 10 kΩ approx. 	<ul style="list-style-type: none"> Signal condition High: +4 V to +V DC (at 3 mA sink current) Low: 0 to +0.6 V DC or Open Input impedance: 10 kΩ approx. 		
Possible external input function	————	Emission halt / Teaching (Full-auto, Limit, 2-point) / Logic operation setting / Copy lock / Display adjustment / Data bank load / Data bank save, selectable			
Sensitivity setting	2-point teaching / Limit teaching / Full-auto teaching / Manual adjustment				
Incident light intensity display range	H-SP / FAST / STD: 0 to 4,000, LONG: 0 to 8,000, U-LG / HYPR: 0 to 9,999				
Timer function	Incorporated with variable OFF-delay / ON-delay / ONE SHOT / ON-delay • OFF-delay / ON-delay • ONE SHOT timer, switchable either effective or ineffective		<Output 1> Incorporated with variable OFF-delay / ON-delay / ONE SHOT / ON-delay • OFF-delay / ON-delay • ONE SHOT timer, switchable either effective or ineffective		
	Timer period	<Output 2> Incorporated with variable OFF-delay / ON-delay / ONE SHOT timer, switchable either effective or ineffective			
	Timer range "ms": 0.5 ms approx., 1 to 9,999 ms approx., 1 ms approx., Timer range "sec.": 0.5 s approx., 1 to 32 s approx., 1 s approx., Timer range "1/10 ms": 0.05 ms approx., 0.1 to 999.9 ms approx., 0.1 ms approx., each output is set individually				
Light emitting amount selection function	Incorporated, 3 levels (each level 25 to 100 %) + Auto setting [1 level (25 to 100 %) when using H-SP mode]				
Interference prevention function	Incorporated (Note 5), selectable either automatic interference prevention or different frequency				
Various settings	Hysteresis setting / Shift amount setting / Emission power setting / Display turning setting / ECO setting / Data bank loading saving setting / Copying setting / Code setting / Reset setting / Logical calculation setting / Threshold tracking setting, etc.				
Protection	IP40 (IEC)				
Ambient temperature	-10 to +55 °C +14 to +131 °F [If 4 to 7 units are mounted in cascade: -10 to +50 °C +14 to +122 °F or if 8 to 16 units (cable type: 8 to 12 units) are mounted in cascade: -10 to +45 °C +14 to +113 °F] (No dew condensation or icing allowed), Storage: -20 to +70 °C -4 to +158 °F				
Emitting element (modulated)	Red LED (Peak emission wavelength: 643 nm 0.025 mil)				
Material	Enclosure, Case cover: Polycarbonate, Switch: TPEE				
Cable	————				0.15 mm ² 6-core cabtyre cable, 2 m 6.562 ft long
Cable extension	————				Extension up to total 100 m 328.084 ft is possible with 0.3 mm ² , or more, cable. (however, supply voltage 12 V DC)
Weight	Net weight: 15 g approx., Gross weight: 70 g approx.				Net weight: 60 g approx., Gross weight: 100 g approx.
Accessory	FX-MB1 (Amplifier protection seal): 1 set				

Notes: 1) Where measurement conditions have not been specified precisely, the conditions used were an ambient temperature of +23 °C **+73.4 °F**.

2) 50 mA max. if 5 or more standard types are connected together. (25 mA in case of 2-output type and cable type)

3) In case of using the quick-connection cable (cable length 5 m **16.404 ft**) (optional).

4) If display adjustment was conducted, it is not in this range.

5) Number of sensor heads which is possible to be mounted closely in auto interference prevention function depends on response time as shown in table below.
Number of sensor heads which is possible to be mounted closely in different frequency Interference prevention function is up to 3 units.

• Number of sensor heads mountable closely (Unit: set)

Response time	H-SP	FAST	STD	LONG	U-LG	HYPR
IP-1	0	2	4	8	8	12

New product
introduction

Tough
Fiber

Fiber
Selection
Guide

Choose
by model

Choose
by shape/
application

Viewing
new models

Fibers

Super
Quality

Threaded
Type

Cylindrical
Type

Sleeve

Flat
Type

Small
Spot

Narroe
Beam

Wide
Beam

Convergent
Reflective
Type

Retroreflective
Type

Chemical-
resistant

Heat-
resistant

Vacuum-
resistant

Liquid Leak /
Liquid Detection

Fiber
Options

Fiber
Dimensions

Thru-beam
Type

Retroreflective
Type

Reflective
Type

Others

Amplifiers

FX-500
series

FX-100
series

Earlier models
comparison
table

INDEX

I/O CIRCUIT AND WIRING DIAGRAMS

FX-501 NPN output type

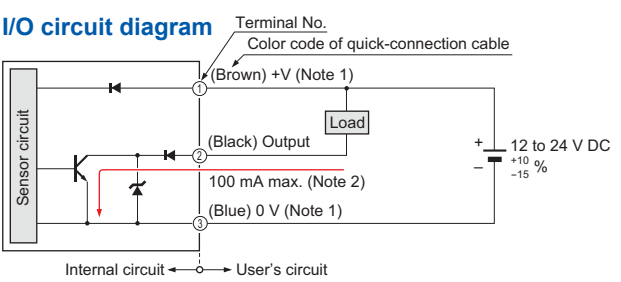

Notes: 1) The quick-connection sub cable does not have +V (brown) and 0 V (blue). The power is supplied from the connector of the main cable.
 2) 50 mA max., if five amplifiers, or more, are connected together.

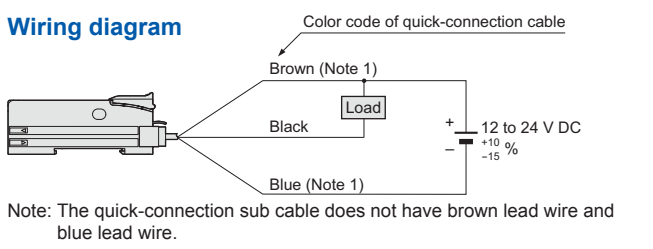

Note: The quick-connection sub cable does not have brown lead wire and blue lead wire.

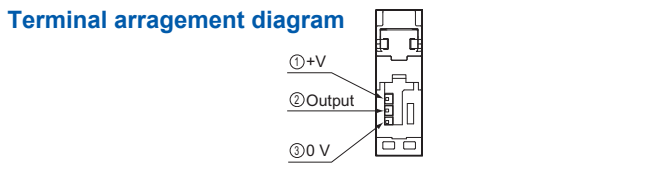

FX-501P PNP output type

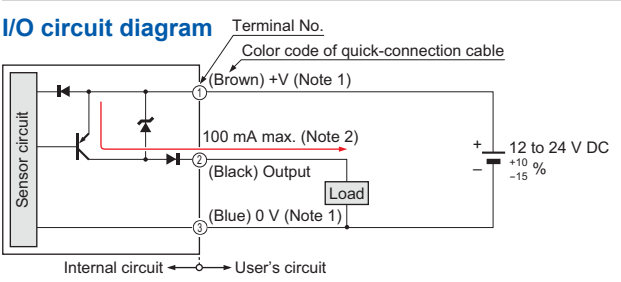

Notes: 1) The quick-connection sub cable does not have +V (brown) and 0 V (blue). The power is supplied from the connector of the main cable.
 2) 50 mA max., if five amplifiers, or more, are connected together.

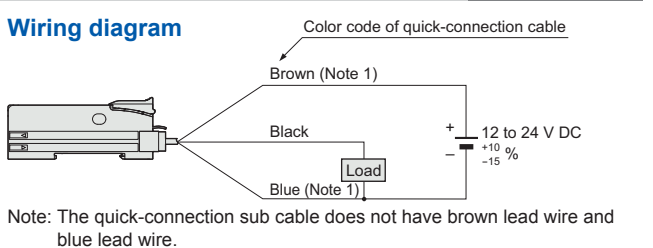

Note: The quick-connection sub cable does not have brown lead wire and blue lead wire.

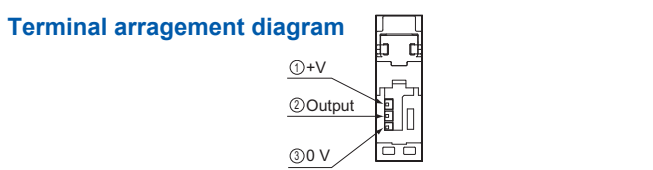

FX-502 NPN output type

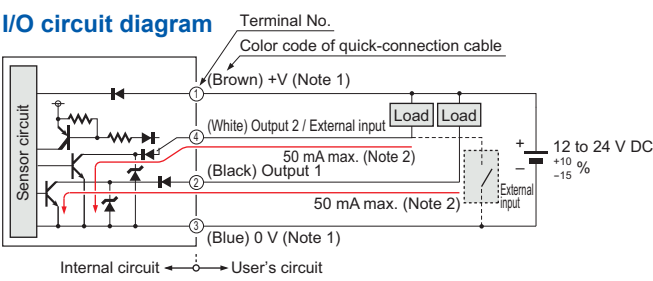

Notes: 1) The quick-connection sub cable does not have +V (brown) and 0 V (blue). The power is supplied from the connector of the main cable.
 2) 25 mA max., if five amplifiers, or more, are connected together.

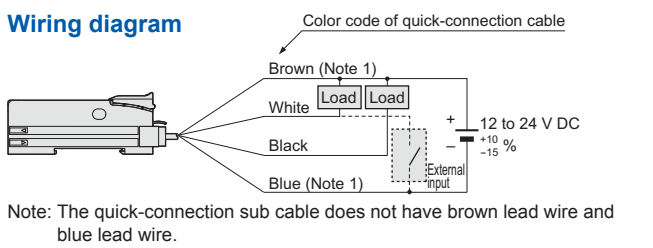

Note: The quick-connection sub cable does not have brown lead wire and blue lead wire.

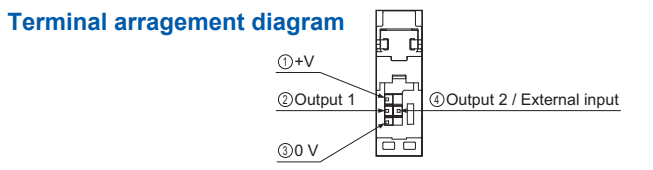

FX-502P PNP output type

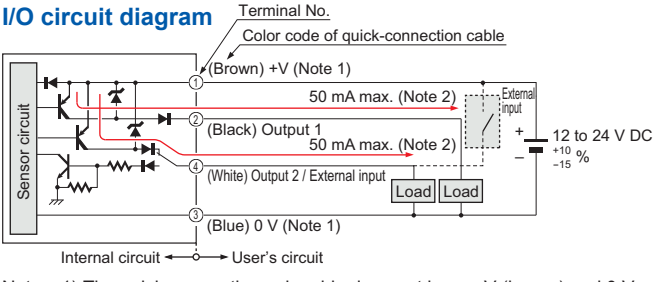

Notes: 1) The quick-connection sub cable does not have +V (brown) and 0 V (blue). The power is supplied from the connector of the main cable.
 2) 25 mA max., if five amplifiers, or more, are connected together.

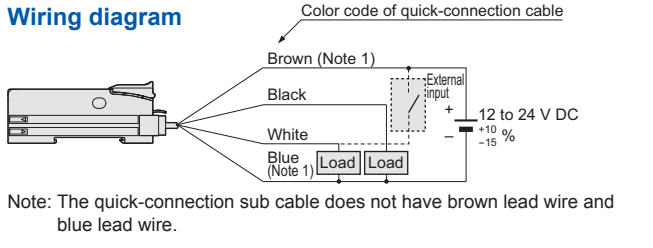

Note: The quick-connection sub cable does not have brown lead wire and blue lead wire.

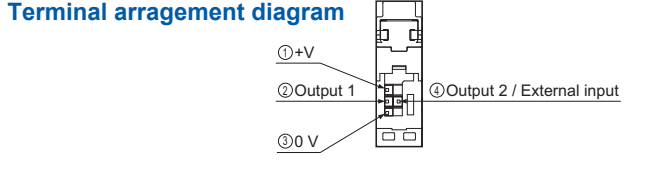

New product introduction
 Tough Fiber
 Fiber Selection Guide
 Choose by model
 Choose by shape/application
 Viewing new models

Fibers
 Super Quality
 Threaded Type
 Cylindrical Type
 Sleeve
 Flat Type
 Small Spot
 Narrow Beam
 Wide Beam
 Convergent Reflective Type
 Retroreflective Type
 Chemical-resistant
 Heat-resistant
 Vacuum-resistant
 Liquid Leak / Liquid Detection

Fiber Options
 Fiber Dimensions
 Thru-beam Type
 Retroreflective Type
 Reflective Type
 Others

Amplifiers
 FX-500 series
 FX-100 series

INDEX

Earlier models comparison table

I/O CIRCUIT AND WIRING DIAGRAMS

FX-505-C2

NPN output type

I/O circuit diagram

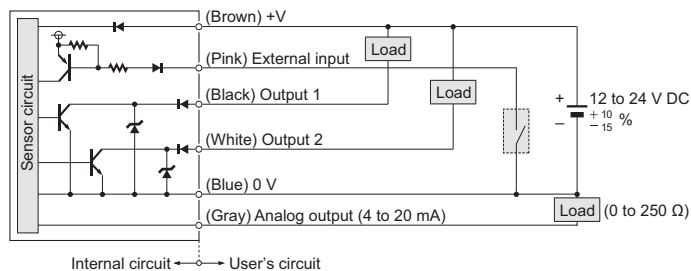

Wiring diagram

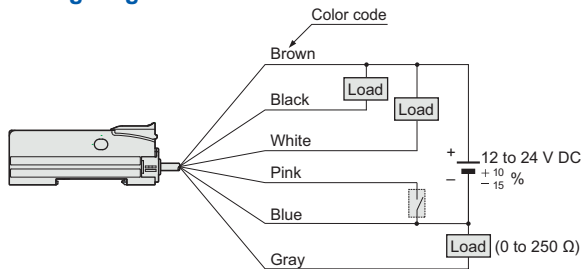

FX-505P-C2

PNP output type

I/O circuit diagram

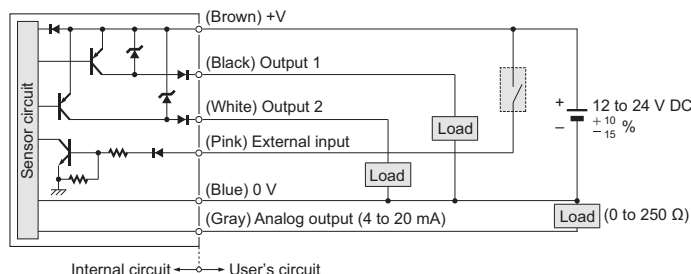

Wiring diagram

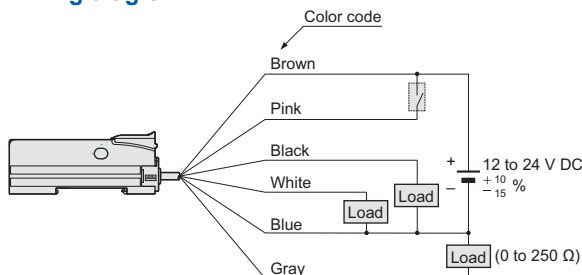

New product introduction
Tough Fiber

Fiber Selection Guide
Choose by model
Choose by shape/application
Viewing new models

Fibers
Super Quality
Threaded Type
Cylindrical Type

Sleeve
Flat Type
Small Spot
Narrow Beam
Wide Beam
Convergent Reflective Type
Retroreflective Type

Chemical-resistant
Heat-resistant
Vacuum-resistant
Liquid Leak / Liquid Detection

Fiber Options

Fiber Dimensions
Thru-beam Type
Retroreflective Type
Reflective Type
Others

Amplifiers
FX-500 series
FX-100 series

INDEX

Earlier models comparison table

PRECAUTIONS FOR PROPER USE

Refer to the "PRO mode operation manual" on our website for details.



- Never use this product as a sensing device for personnel protection.
- In case of using sensing devices for personnel protection, use products which meet laws and standards, such as OSHA, ANSI or IEC etc., for personnel protection applicable in each region or country.

Wiring

- Make sure that the power supply is OFF while adding or removing the amplifiers.
- Note that if a voltage exceeding the reted range is applied, or if an AC power supply is directly connected, the product may get burnt or damaged.
- Note that short-circuit of the load or wrong wiring may burn or damage the product.
- Do not run the wires together with high-voltage lines or power lines, or put them in the same raceway. This can cause malfunction due to induction.
- Verify that the supply voltage variation is within the rating.
- If power is supplied from a commercial switching regulator, ensure that the frame ground (F.G.) terminal of the power supply is connected to an actual ground.
- In case noise generating equipment (switching regulator, inverter motor, etc.) is used in the vicinity of this product, connect the frame ground (F.G.) terminal of the equipment to an actual ground.
- Make sure to use the quick-connection cable (optional) for the connection of the controller.
Extension up to total 100 m [328.084 ft](#) is possible with 0.3 mm² or more, cable.
However, in order to reduce noise, make the wiring as short as possible.
- Make sure that stress by forcible bending or pulling is not applied to the sensor cable joint and fiber cable.

Others

- Our products have been developed / produced for industrial use only.
- The specification may not be satisfied in a strong magnetic field.
- The ultra long distance (U-LG, HYPR) mode is more likely to be affected by extraneous noise since the sensitivity of that is higher than the other modes. Make sure to check the environment before use.
- Do not use during the initial transient time (H-SP, FAST, STD: 0.5 sec., LONG, U-LG, HYPR: 1 sec.) after the power supply is switched ON.
- These sensors are only for indoor use.
- Avoid dust, dirt, and steam.
- Make sure that the product does not come in contact with oil, grease, organic solvents such as thinner, etc., strong acid or alkaline.
- This product cannot be used in an environment containing inflammable or explosive gases.
- Never disassemble or modify this product.
- This product adopts EEPROM. Settings cannot be done 100 thousand times or more because of the EEPROM's lifetime.

New product introduction

Tough Fiber

Fiber Selection Guide

Choose by model

Choose by shape/application

Viewing new models

Fibers

Super Quality

Threaded Type

Cylindrical Type

Sleeve

Flat Type

Small Spot

Narrow Beam

Wide Beam

Convergent Reflective Type

Retroreflective Type

Chemical-resistant

Heat-resistant

Vacuum-resistant

Liquid Leak / Liquid Detection

Fiber Options

Fiber Dimensions

Thru-beam Type

Retroreflective Type

Reflective Type

Others

Amplifiers

FX-500 series

FX-100 series

INDEX

Earlier models comparison table

DIMENSIONS (Unit: mm in)

The CAD data in the dimensions can be downloaded from our website.

FX-501(P) FX-502(P) Amplifier

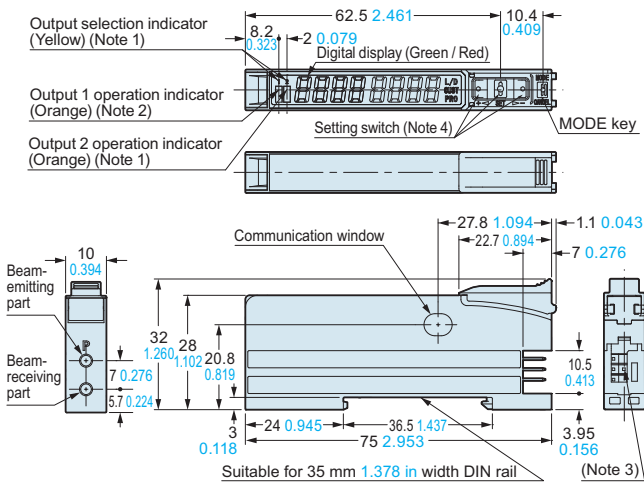

- Notes: 1) **FX-502(P)** only
 2) **FX-501(P)**: Operation indicator
 3) **FX-501(P)**: 3-pin, **FX-502(P)**: 4-pin
 4) The shape of setting switch will be changed from production at the end of November, 2011. Please see drawing below.

After the modification

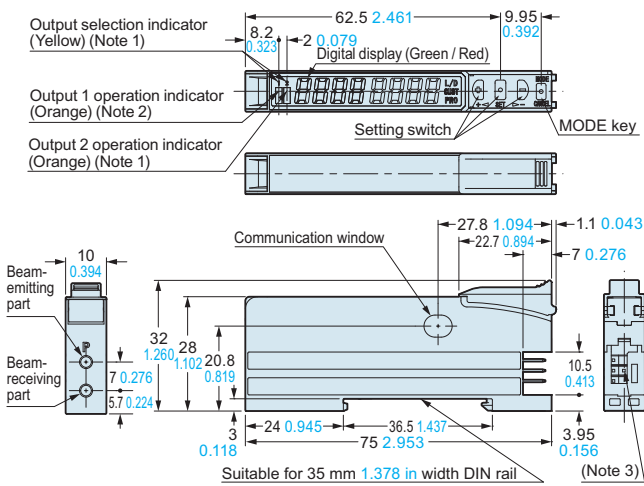

- Notes: 1) **FX-502(P)** only
 2) **FX-501(P)**: Operation indicator
 3) **FX-501(P)**: 3-pin, **FX-502(P)**: 4-pin

FX-505-C2 FX-505P-C2 Amplifier

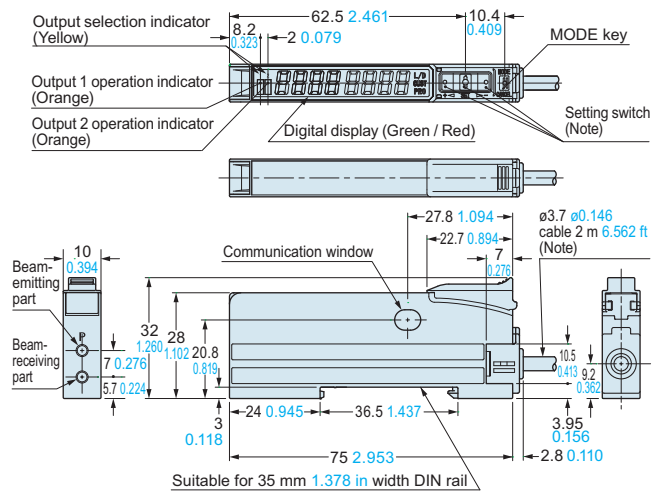

Note: The shape of setting switch and cable will be changed from production at the end of November, 2011. Please see drawing below.

After the modification

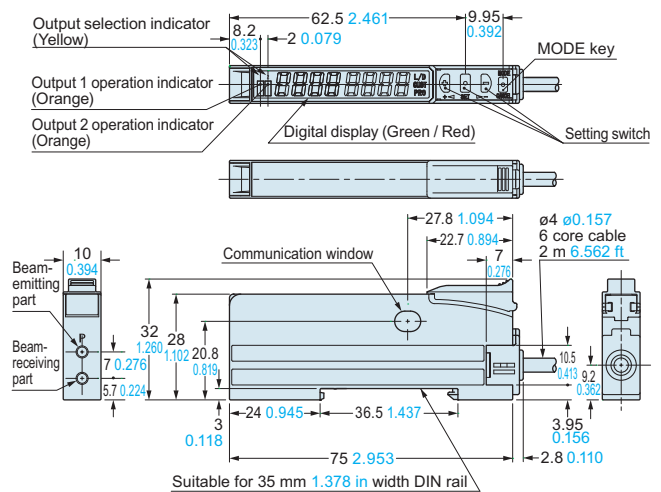

New product introduction
 Tough Fiber
 Fiber Selection Guide
 Choose by model
 Choose by shape/application
 Viewing new models

Fibers
 Super Quality
 Threaded Type
 Cylindrical Type
 Sleeve
 Flat Type
 Small Spot
 Narrow Beam
 Wide Beam
 Convergent Reflective Type
 Retroreflective Type
 Chemical-resistant
 Heat-resistant
 Vacuum-resistant
 Liquid Leak / Liquid Detection

Fiber Options
 Fiber Dimensions
 Thru-beam Type
 Retroreflective Type
 Reflective Type
 Others

Amplifiers
 FX-500 series
 FX-100 series

INDEX

Earlier models comparison table

DIMENSIONS (Unit: mm in)

The CAD data in the dimensions can be downloaded from our website.

CN-73-C□ CN-74-C□ Main cable (Optional)

• Length L

Model No.	Length L
CN-73/74-C1	1,000 39.370
CN-73/74-C2	2,000 78.740
CN-73/74-C5	5,000 196.850

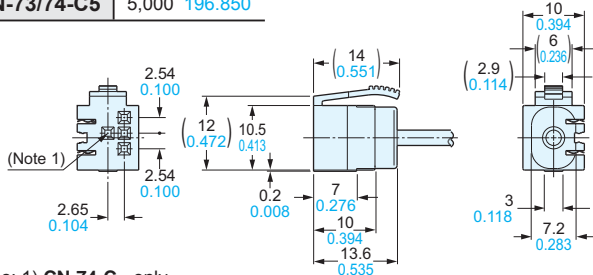
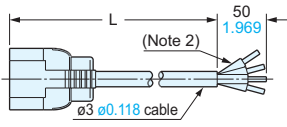

Notes: 1) CN-74-C□ only
2) CN-73-C□: 3-core

CN-71-C□ CN-72-C□ Sub cable (Optional)

• Length L

Model No.	Length L
CN-71/72-C1	1,000 39.370
CN-71/72-C2	2,000 78.740
CN-71/72-C5	5,000 196.850

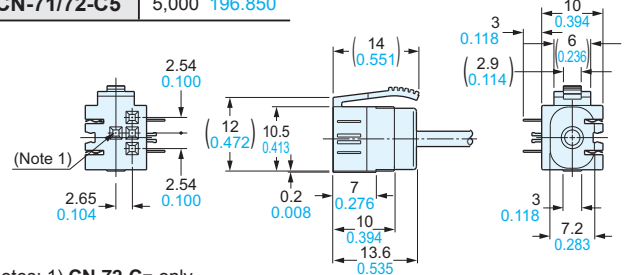
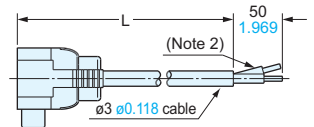

Notes: 1) CN-72-C□ only
2) CN-71-C□: 1-core

MS-DIN-2 Amplifier mounting bracket (Optional)

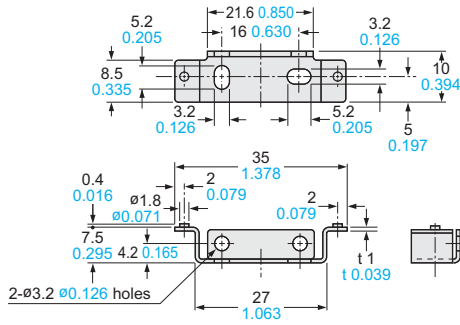

Material: Cold rolled carbon steel (SPCC)
(Uni-chrome plated)

MS-DIN-E End plate (Optional)

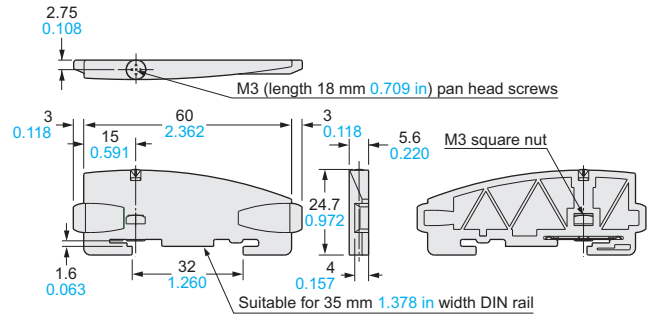

Material: Polycarbonate

New product introduction

Tough Fiber

Fiber Selection Guide

Choose by model

Choose by shape/application

Viewing new models

Fibers

Super Quality

Threaded Type

Cylindrical Type

Sleeve

Flat Type

Small Spot

Narrow Beam

Wide Beam

Convergent Reflective Type

Retroreflective Type

Chemical-resistant

Heat-resistant

Vacuum-resistant

Liquid Leak / Liquid Detection

Fiber Options

Fiber Dimensions

Thru-beam Type

Retroreflective Type

Reflective Type

Others

Amplifiers

FX-500 series

FX-100 series

INDEX

Earlier models comparison table

New product introduction
Tough Fiber

Fiber Selection Guide
Choose by model
Choose by shape/application
Viewing new models

Fibers
Super Quality
Threaded Type
Cylindrical Type
Sleeve
Flat Type
Small Spot
Narrow Beam
Wide Beam
Convergent Reflective Type
Retroreflective Type
Chemical-resistant
Heat-resistant
Vacuum-resistant
Liquid Leak / Liquid Detection

Fiber Options

Fiber Dimensions
Thru-beam Type
Retroreflective Type
Reflective Type
Others

Amplifiers
FX-500 series
FX-100 series

INDEX

Earlier models comparison table

Taking fiber sensors to the next level



FX-100 series has been modified from July 2011 production. The color of enclosure has been changed from white to dark gray and the protection cover has been attached.

Saving-space with a width of 9 mm 0.354 in

Very slim at only 9 mm 0.354 in. This is much thinner than existing fiber sensors. Even if the difference is small when only using one unit, when using many units this makes a very large difference.



Improved stability over both long terms

Utilizes the standard Panasonic Electric Works SUNX digital fiber sensor element "Four-chemical emitting element" for light emission. The light emission is guaranteed to be stable over long periods of time.

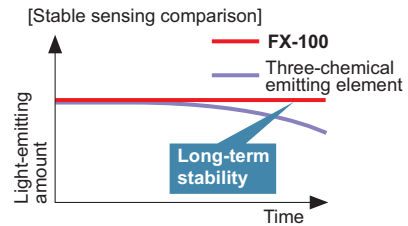

Teaching using ON / OFF buttons SET mode

Simply press the ON button when an object is present and OFF when it is not.

<Setting example>

Thru-beam type / Retroreflective type

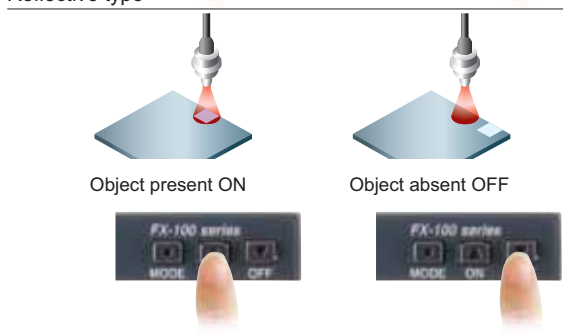
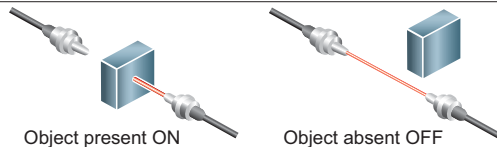

Resolves variation in incident light intensity display GETA function PRO mode

Even when performing the same sensing operation, there may be variances in the digital values of the fiber amp.

Given value can be corrected with the GETA function, so the apparent variation can be eliminated.

Variations in the amount of light received



Unify at 500 using the GETA function

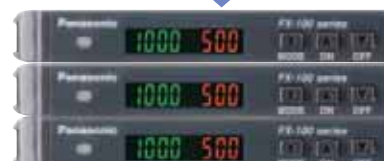

Stable detection by attenuation function SET mode

If the light receiving level becomes saturated when sensing over short distances or when sensing transparent objects or minute objects, the light emitting amount can be reduced so that stable sensing can be provided without needing to change the response time. Light reduction: 3 levels plus an automatic mode



Interference prevention function SET mode

FX-101 □: Interference prevention for up to 3 units
FX-102 □: Interference prevention for up to 4 units

The emission frequencies can be set separately for each unit in order to avoid interference. The emitted light flashes while setting is in progress, so that you can see at a glance which fiber sensor is currently being set.

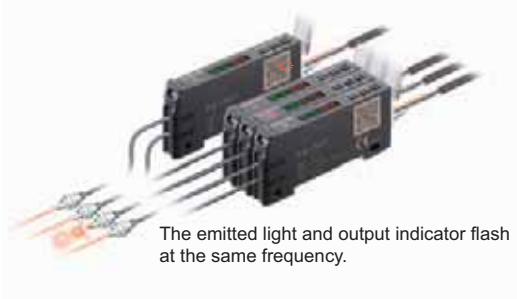

Multi-function external input PRO mode

Settings such as emission halt, limit / auto teaching, 2-point teaching and ECO settings can be carried out via external input. Also, the threshold value can be memorized.

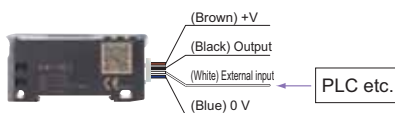

External input lines are equipped as standard

Setting copy function to reduce man-hours and human error PRO mode

By cable wiring, the master sensor settings can be copied along with data transmissions. By synchronizing the settings on all the devices, trouble from setting errors can be prevented.

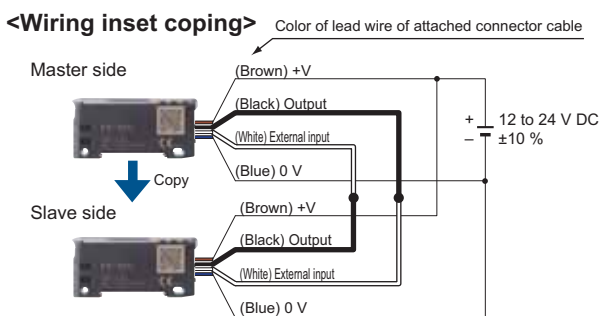

Copiable setting

Threshold value, output operation setting, timer operation setting, timer period setting, light-emitting amount selection setting (attenuation function), shift setting, ECO setting, digital display inversion setting, and threshold value margin setting (alert function)

*The copy unit **SC-SU1** which can copy settings in one touch is available. (optional)

Electricity consumption saving possibilities ECO

After setting, if about 20 seconds go by without any key operations taking place the digital display will turn off and energy consumption is kept under 600 mW. (When illuminated it is under 720 mW)

Commercially-available connectors are used so that lead time and spare part numbers can both be reduced

The connectors used are commercially-available connectors, so that processing costs and lead time required for carrying out processing after purchase of the sensors can be greatly reduced. The same connection parts as the **DP-100** series of digital pressure sensors and the **PM-64** series of micro photoelectric sensors can be used.

Commercially-available press-fit connectors are used, so that the processing costs for connection cables can be greatly reduced.

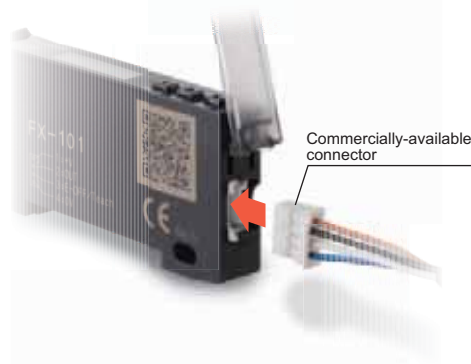

New product introduction
 Tough Fiber
 Fiber Selection Guide
 Choose by model
 Choose by shape/application
 Viewing new models

Fibers
 Super Quality
 Threaded Type
 Cylindrical Type
 Sleeve
 Flat Type
 Small Spot
 Narroe Beam
 Wide Beam
 Convergent Reflective Type
 Retroreflective Type
 Chemical-resistant
 Heat-resistant
 Vacuum-resistant
 Liquid Leak / Liquid Detection

Fiber Options
 Fiber Dimensions
 Thru-beam Type
 Retroreflective Type
 Reflective Type
 Others

Amplifiers
 FX-500 series
 FX-100 series

INDEX

Earlier models comparison table

ORDER GUIDE

Amplifiers

Type	Appearance	Model No.	Emitting element	Output
Standard type		FX-101 (Note 2)	Red LED	NPN open-collector transistor
		FX-101-Z (Note 3)		NPN open-collector transistor
		FX-101P (Note 2)		PNP open-collector transistor
		FX-101P-Z (Note 3)		PNP open-collector transistor
		FX-101-CC2		NPN open-collector transistor
Long sensing range type		FX-101P-CC2		PNP open-collector collector transistor
		FX-102 (Note 2)		NPN open-collector transistor
		FX-102-Z (Note 3)		NPN open-collector transistor
		FX-102P (Note 2)		PNP open-collector transistor
		FX-102P-Z (Note 3)		PNP open-collector transistor
		FX-102-CC2	NPN open-collector transistor	
		FX-102P-CC2	PNP open-collector transistor	

Notes: 1) The connector attached cable **CN-14A-C2** is supplied with the amplifier.
 2) Make sure to use the optional connector attached cable **CN-14A(-R)-C□** or the connector **CN-14A**, or a connector manufactured by J.S.T. Mfg. Co., Ltd. (contact: SPHD-001T-P0.5, housing: PAP-04V-S)
 3) Make sure to use the optional M8 connector attached cable **CN-24A-C□**.

Accessory

- **CN-14A-C2**
 (Connector attached cable 2 m 6.562 ft)
 * Only include cable set type



- **FC-FX-1** (Protection cover)
 * It has been attached from the production at July, 2011.

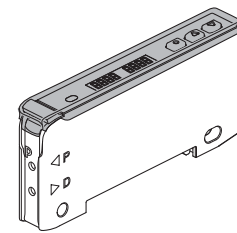

OPTIONS

Designation	Model No.	Description	
Connector attached cable	CN-14A-C1	1 m 3.281 ft	0.2 mm ² 4-core cable with connector on one end Cable outer diameter: ø3.7 mm ø0.146 in
	CN-14A-C2 (Note 1)	2 m 6.562 ft	
	CN-14A-C3	3 m 9.843 ft	
	CN-14A-C5	5 m 16.404 ft	
Connector attached cable (Flexible type)	CN-14A-R-C1	1 m 3.281 ft	
	CN-14A-R-C2	2 m 6.562 ft	
	CN-14A-R-C3	3 m 9.843 ft	
	CN-14A-R-C5	5 m 16.404 ft	
M8 connector attached cable	CN-24A-C2	2 m 6.562 ft	For M8 plug-in connector type The connector on one end Cable outer diameter: ø4 mm ø0.157 in
	CN-24A-C5	5 m 16.404 ft	
Connector	CN-14A	Set of 10 housings and 40 contacts	
Amplifier mounting bracket	MS-DIN-4	Mounting bracket for amplifier	
End plates	MS-DIN-E	When it moves depending on the way it is installed on a DIN rail, these end plates ensure that all amplifiers are mounted together in a secure and fully connected manner.	
Copy unit	SC-SU1	Copy the controller settings to other controllers.	

Note: The connector attached cable **CN-14A-C2** is supplied with the cable set type **FX-10□-CC2**.

Recommended connector

Contact: SPHD-001T-P0.5, Housing: PAP-04V-S (Manufactured by J.S.T. Mfg. Co., Ltd.)
 Note: Contact the manufacturer for details of the recommended products.

Recommended crimping tool

Model No.: YC-610R (Manufactured by J.S.T. Mfg. Co., Ltd.)
 Note: Contact the manufacturer for details of the recommended products.

M8 connector attached cable

- **CN-24A-C□**

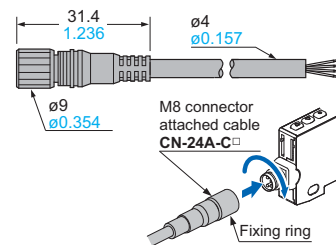

Amplifier mounting bracket

- **MS-DIN-4**

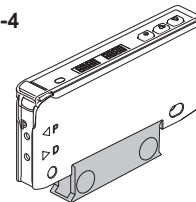

Connector attached cable

- **CN-14A(-R)-C□**

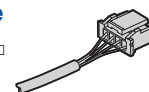

Connector

- **CN-14A**

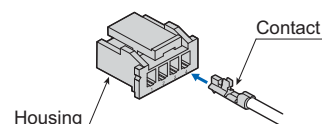

New product introduction
Tough Fiber

Fiber Selection Guide
Choose by model
Choose by shape/application
Viewing new models

Fibers
Super Quality
Threaded Type
Cylindrical Type
Sleeve
Flat Type
Small Spot
Narrow Beam
Wide Beam
Convergent Reflective Type
Retroreflective Type
Chemical-resistant
Heat-resistant
Vacuum-resistant
Liquid Leak / Liquid Detection

Fiber Options
Fiber Dimensions
Thru-beam Type
Retroreflective Type
Reflective Type
Others

Amplifiers
FX-500 series
FX-100 series

INDEX

Earlier models comparison table

SPECIFICATIONS

Item	Model No.	Type	Standard type		Long sensing range type	
				Cable set		Cable set
		NPN output	FX-101(-Z) (Note 5)	FX-101-CC2	FX-102(-Z) (Note 5)	FX-102-CC2
		PNP output	FX-101P(-Z) (Note 5)	FX-101P-CC2	FX-102P(-Z) (Note 5)	FX-102P-CC2
Supply voltage		12 to 24 V DC $\pm 10\%$ Ripple P-P 10 % or less				
Power consumption		Normal operation: 720 mW or less (Current consumption 30 mA or less at 24 V supply voltage) ECO mode: 600 mW or less (Current consumption 25 mA or less at 24 V supply voltage)				
Output		<NPN output type> NPN open-collector transistor <ul style="list-style-type: none"> • Maximum sink current: 100 mA • Applied voltage: 30 V DC or less (between output and 0 V) • Residual voltage: 1.5 V or less (at 100 mA sink current) 		<PNP output type> PNP open-collector transistor <ul style="list-style-type: none"> • Maximum source current: 100 mA • Applied voltage: 30 V DC or less (between output and +V) • Residual voltage: 1.5 V or less (at 100 mA source current) 		
Output operation		Selectable either Light-ON or Dark-ON, at SET mode				
Short-circuit protection		Incorporated				
External input		<NPN output type> NPN non-contact input <ul style="list-style-type: none"> • Signal condition High: +8 V to +V DC or Open Low: 0 to +2 V DC (Source current 0.5 mA or less) • Input impedance: 10 kΩ approx. 		<PNP output type> PNP non-contact input <ul style="list-style-type: none"> • Signal condition High: +4 V to +V DC (Sink current 0.5 to 3 mA) Low: 0 to +0.6 V DC or Open • Input impedance: 10 kΩ approx. 		
Response time		Emission frequency 0: 250 μ s or less (factory default setting) Emission frequency 1: 450 μ s or less Emission frequency 2: 500 μ s or less Emission frequency 3: 600 μ s or less		Emission frequency 1: 2.5 ms or less (factory default setting) Emission frequency 2: 2.8 ms or less Emission frequency 3: 3.2 ms or less Emission frequency 4: 5.0 ms or less		
Sensitivity setting		2-point teaching / Limit teaching / Full-auto teaching				
Operation indicator		Orange LED (lights up when the output is ON)				
Digital display		4 digits (green) + 4 digits (red) LCD display				
Fine sensitivity adjustment function		Incorporated				
Timer function		ON-delay / OFF-delay timer, switchable either effective or ineffective [Timer period: 1 ms, 5 ms, 10 ms, 20 ms, 40 ms, 50 ms, 100 ms, 500 ms, 1,000 ms]				
Attenuation function		3-level + Auto setting				
Interference prevention function		Incorporated Emission frequency selection method (Note 2) (Functions at emission frequency 1, 2 or 3)		Incorporated Emission frequency selection method (Note 2) (Functions at emission frequency 1, 2, 3 or 4)		
Environmental resistance	Ambient temperature	-10 to +55 °C +14 to +131 °F (If 4 to 7 units are mounted close together: -10 to +50 °C +14 to +122 °F, if 8 to 16 units are mounted close together: -10 to +45 °C +14 to +113 °F) (No dew condensation or icing allowed), Storage: -20 to +70 °C -4 to +158 °F				
	Ambient humidity	35 to 85 % RH, Storage: 35 to 85 % RH				
	Ambient illuminance	Incandescent light: 3,000 lx at the light-receiving face				
	Voltage withstandability	1,000 V AC for one min. between all supply terminals connected together and enclosure (Note 3)				
	Insulation resistance	20 M Ω , or more, with 250 V DC megger between all supply terminals connected together and enclosure (Note 3)				
	Vibration resistance	10 to 150 Hz frequency, 0.75 mm 0.030 in amplitude in X, Y and Z directions for two hours each				
	Shock resistance	98 m/s ² acceleration (10 G approx.) in X, Y and Z directions for five times each				
Emitting element (modulated)		Red LED (Peak emission wavelength: 632 nm 0.025 mil)				
Material		Enclosure: Polycarbonate, Key switch: Polycarbonate, Fiber lock lever: PBT				
Connecting method		Connector (Note 4)				
Cable length		Total length up to 100 m 328.084 ft is possible with 0.3 mm ² , or more, cable.				
Weight		Net weight: 15 g approx. Gross weight: 35 g approx.	Net weight: 15 g approx. Gross weight: 75 g approx.	Net weight: 15 g approx. Gross weight: 35 g approx.	Net weight: 15 g approx. Gross weight: 75 g approx.	
Accessory		FC-FX-1 (Protection cover): 1 pc. (Note 6)	FC-FX-1 (Protection cover): 1 pc. (Note 6) CN-14A-C2 (Connector attached cable, 2 m 6.562 ft long): 1 pc.	FC-FX-1 (Protection cover): 1 pc. (Note 6)	FC-FX-1 (Protection cover): 1 pc. (Note 6) CN-14A-C2 (Connector attached cable, 2 m 6.562 ft long): 1 pc.	

Notes: 1) Where measurement conditions have not been specified precisely, the conditions used were an ambient temperature of +23 °C +73.4 °F.

2) When using the interference prevention function, set the emission frequencies for the amplifiers to be covered by the interference prevention function to different frequency values.

However, the interference prevention function does not operate at emission frequency 0 (factory default setting) for the **FX-101(P)(-Z)** / **FX-101(P)-CC2**.

3) The voltage withstandability and the insulation resistance values given in the above table are for the amplifier only.

4) Connector attached cable **CN-14A-C2** is not attached to the models that have no "-CC2" at the end of the model Nos.

Make sure to use the optional connector attached cable **CN-14A(-R)-C** or the connector **CN-14A**, or a connector manufactured by J.S.T. Mfg., Ltd. (contact: SPHD-001T-P0.5, housing: PAP-04V-S).

5) Model Nos. having the suffix "-Z" are M8 plug-in connector type. Make sure to use the optional M8 attached connector cable **CN-24A-C**.

6) Protection cover **FC-FX-1** has been attached from the production at July, 2011.

New product introduction

Tough Fiber

Fiber Selection Guide

Choose by model

Choose by shape/application

Viewing new models

Fibers

Super Quality

Threaded Type

Cylindrical Type

Sleeve

Flat Type

Small Spot

Narrow Beam

Wide Beam

Convergent Reflective Type

Retroreflective Type

Chemical-resistant

Heat-resistant

Vacuum-resistant

Liquid Leak / Liquid Detection

Fiber Options

Fiber Dimensions

Thru-beam Type

Retroreflective Type

Reflective Type

Others

Amplifiers

FX-500 series

FX-100 series

INDEX

Earlier models comparison table

I/O CIRCUIT AND WIRING DIAGRAMS

FX-10□(-Z/-CC2)

NPN output type

I/O circuit diagram

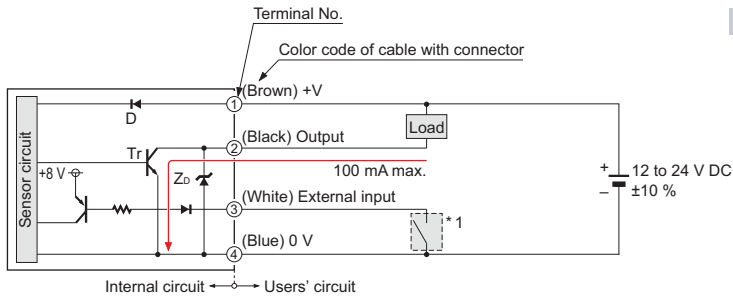

Terminal arrangement diagram

Connector type

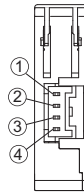

Terminal No.	Function
①	+V
②	Output
③	External input
④	0 V

M8 plug-in connector type

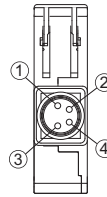

Terminal No.	Function
①	+V
②	Output
③	External input
④	0 V

Symbols ... D : Reverse supply polarity protection diode
 Z_D: Surge absorption zener diode
 Tr : NPN output transistor

* 1

Non-voltage contact or NPN open-collector transistor

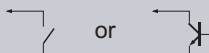

High (+8 V to +V DC, or open): Ineffective
 Low [0 to +2 V DC (source current 0.5 mA or less)]: Effective

FX-10□P(-Z/-CC2)

PNP output type

I/O circuit diagram

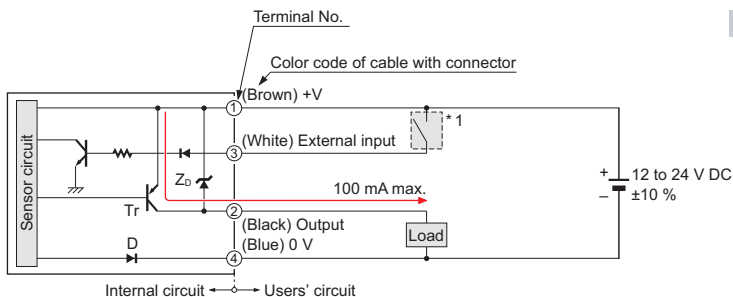

Terminal arrangement diagram

Connector type

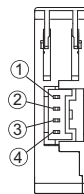

Terminal No.	Function
①	+V
②	Output
③	External input
④	0 V

M8 plug-in connector type

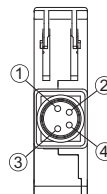

Terminal No.	Function
①	+V
②	Output
③	External input
④	0 V

Symbols ... D : Reverse supply polarity protection diode
 Z_D: Surge absorption zener diode
 Tr : PNP output transistor

* 1

Non-voltage contact or PNP open-collector transistor

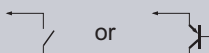

High [+4 V to +V DC (sink current 0.5 to 3 mA)]: Effective
 Low (0 to +0.6 V DC, or open): Ineffective

New product introduction
 Tough Fiber
 Fiber Selection Guide
 Choose by model
 Choose by shape/application
 Viewing new models

Fibers
 Super Quality
 Threaded Type
 Cylindrical Type
 Sleeve
 Flat Type
 Small Spot
 Narrow Beam
 Wide Beam
 Convergent Reflective Type
 Retroreflective Type
 Chemical-resistant
 Heat-resistant
 Vacuum-resistant
 Liquid Leak / Liquid Detection

Fiber Options
 Fiber Dimensions
 Thru-beam Type
 Retroreflective Type
 Reflective Type
 Others

Amplifiers
 FX-500 series
 FX-100 series

INDEX

Earlier models comparison table

PRECAUTIONS FOR PROPER USE



- Never use this product as a sensing device for personnel protection.
- In case of using sensing devices for personnel protection, use products which meet laws and standards, such as OSHA, ANSI or IEC etc., for personnel protection applicable in each region or country.

Using in combination with the FX-300 / FX-410 series

- The **FX-100** series does not use the horizontal connectors that are used with the **FX-300 / FX-410** series. Please note that horizontal connection cannot be performed using a connector attached cable. In addition, the optical communication function is not equipped on the **FX-100** series, so it is unable to perform interference prevention for use with the **FX-300 / FX-410** series. If using the **FX-100** series together with the **FX-300 / FX-410** series side-by-side, please set the same models together in groups.

Mounting

<When using a DIN rail>

How to mount the amplifier

- ① Fit the rear part of the mounting section of the amplifier on a 35 mm 1.378 in width DIN rail.
- ② Press down the rear part of the mounting section of the unit on the 35 mm 1.378 in width DIN rail and fit the front part of the mounting section to the DIN rail.

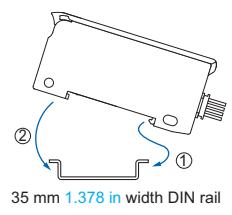

How to remove the amplifier

- ① Push the amplifier forward.
- ② Lift up the front part of the amplifier to remove it.

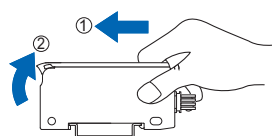

Note: Take care that if the front part is lifted without pushing the amplifier forward, the hook on the rear portion of the mounting section is likely to break.

<When using screws with washers>

- Use M3 screws with washers for mounting. The tightening torque should be 0.5 N·m or less.

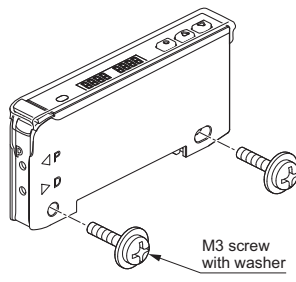

Refer to the "Operation Guide" on our website for details pertaining to operating instructions for the amplifier.

Wiring

- Make sure that the power supply is OFF while adding or removing the amplifiers.
- Note that if a voltage exceeding the rated range is applied, or if an AC power supply is directly connected, the product may get burnt or damaged.
- Note that short-circuit of the load or wrong wiring may burn or damage the product.
- Do not run the wires together with high-voltage lines or power lines, or put them in the same raceway. This can cause malfunction due to induction.
- Verify that the supply voltage variation is within the rating.
- If power is supplied from a commercial switching regulator, ensure that the frame ground (F.G.) terminal of the power supply is connected to an actual ground.
- In case noise generating equipment (switching regulator, inverter motor, etc.) is used in the vicinity of this product, connect the frame ground (F.G.) terminal of the equipment to an actual ground.
- Make sure to use the quick-connection cable (optional) for the connection of the controller. Extension up to total 100 m 328.084 ft is possible with 0.3 mm² or more, cable. However, in order to reduce noise, make the wiring as short as possible.

Part description

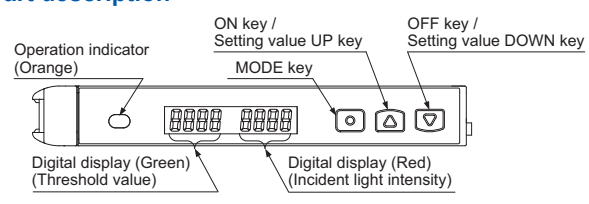

Setting mode

- Setting mode appears after the MODE key is pressed for 2 sec. in RUN mode.

Setting item	Factory setting	Description
Teaching mode	TeAch	Threshold value can be set in 2-point teaching, limit teaching, or full-auto teaching.
Output operation setting	Light On [Dark-ON]	Light-ON or Dark-ON can be set.
Timer operation setting	del non [Without timer]	Without timer, ON delay timer, or OFF delay timer can be set.
Timer setting	on 10 [ON-delay timer: 10 ms] off 10 [OFF-delay timer: 10 ms]	In case of setting ON-delay timer or OFF-delay timer in the timer operation setting mode, timer can be set. When timer is not set, this mode is not displayed.
Emission amount setting	Pct 1111 Level 3	Setting for reduced intensity of emission amount is possible when the incident light intensity is saturated.
Emission frequency setting	FX-101 FrEq F-0 [0 (Response time: 250 μs or less)] FX-102 FrEq F-01 [1 (Response time: 2.5 ms or less)]	In case of using the fiber heads in parallel, interference can be prevented by setting different emission frequency. However, when emission frequency 0 is set, interference cannot be prevented. Response time corresponds to emission frequency.

New product introduction

Tough Fiber

Fiber Selection Guide

Choose by model

Choose by shape/application

Viewing new models

Fibers

Super Quality

Threaded Type

Cylindrical Type

Sleeve

Flat Type

Small Spot

Narrow Beam

Wide Beam

Convergent Reflective Type

Retroreflective Type

Chemical-resistant

Heat-resistant

Vacuum-resistant

Liquid Leak / Liquid Detection

Fiber Options

Fiber Dimensions

Thru-beam Type

Retroreflective Type

Reflective Type

Others

Amplifiers

FX-500 series

FX-100 series

INDEX

Earlier models comparison table

PRECAUTIONS FOR PROPER USE

PRO mode

- PRO mode appears after the MODE key is pressed for 4 sec. in RUN mode.

Setting item	Factory setting	Description
Shift setting	(Shift amount 15%)	Shift amount can be selected from 0 to 80 % in the limit teaching. Select 0 % when it is desired to set the present incident light intensity as a threshold value.
External input setting	[Emission halt]	External input can be selected from emission halt, limit teaching [+], limit teaching [-], full-auto teaching, ECO (Note 1), 2-point teaching or emission amount test. When setting the incident light intensity test "E-E", output turns ON / OFF every 100ms when the rate of incident light intensity and threshold value is less than half of the set shift amount (for example, when the rate of incident light intensity and threshold value is within ± 10 % for 20 % of shift amount) at external input.
Threshold value-storing setting mode (Note 2)	[OFF]	Threshold value set at the limit teaching, full-auto teaching or 2-point teaching by external input is stored. When selecting Auto in the emission amount setting mode, the set emission amount level is also stored.
Threshold value follow-up cycle setting (Note 3)	[OFF]	When incident light intensity exceeds threshold value, this mode can change the threshold value with each set cycle depending on variations of the incident light intensity. The follow-up shift amount is same as the one set in the shift setting mode. However, the threshold value is not stored.
GETA function setting (Note 4, 5)	[OFF]	Variations can be reduced by correcting the present incident light intensity in each amplifier to a target value. Target value to offset incident light intensity can be selected from 0 to 2,000 by 100 unit each. For example, if the target value is set to 2,000 when the incident light intensity is 1,500, the incident light intensity becomes 2,000.
ECO setting	[OFF]	It is possible to light up / turn off the digital display. When ECO setting mode is ON, the display turns off in 20 sec. approx. in RUN mode. To light up the display again, press any key for 2 sec. or more.
Digital display inversion setting	[OFF]	Digital display can be inverted.
Threshold value margin setting	[OFF]	Margin for threshold value to the present incident light intensity can be checked. When there is no margin, it is possible to make the digital display blink. off : Set to "OFF": does not function. Green : Green blinks. Red : Red blinks. RL : Red and green blink. In-t : When conducting limit teaching or 2-point teaching by external input, in case the rate of reference incident light intensity and threshold value after teaching is 200% or more, or in case it is less than half of the shift amount, output turns ON / OFF every 100 ms. (Note 6)
Setting copy	[NO]	The settings of the master side amplifier can be copied to the slave side amplifier. For details, refer to "Setting copy function".
Reset	[NO]	Returns to default settings (factory settings.)

- Notes: 1) When ECO is selected at the external input setting mode, key operation on the main body is invalid during external input.
2) This mode is not indicated unless any of "LtcP", "Ltc-", "Aut" or "2-Pt" is set at the external input setting mode.
3) If the incident light intensity becomes "300" or less, the follow-up operation stops. In that condition, threshold value [digital display (green)] blinks. This function can be used when thru-beam type or retroreflective type fiber is applied to this product. If reflective type fiber is applied, the function cannot be used depending on use conditions.
4) If MODE key is pressed in RUN mode when GETA function is used, the incident light intensity before setting GETA function is displayed on the red digital display for 2 sec. approx.
5) When GETA function is used in saturation of incident light intensity (4,000 or more,) "HRd" is indicated on the red digital display. Correction value is up to 4,000.
6) This mode does not operate unless any of "LtcP", "Ltc-" or "2-Pt" is set at the external input setting mode.

Refer to the "Operation Guide" on our website for details pertaining to operating instructions for the amplifier.

Setting copy function

- This can copy the settings of the master side amplifier to the slave side amplifier.

- Be sure to use the setting copy function between the identical models (Between FX-101□ models or FX-102□ models). This function cannot be used between different models.
- Only one sensor can be connected on slave side with a master side sensor for the setting copy function.
- Threshold value, output operation setting, timer operation setting, timer setting, light-emitting amount setting, shift setting, external input setting, threshold value margin setting, ECO setting, digital display inversion setting, and threshold value margin setting can be copied.

<Setting procedures>

- Set the setting copy mode of the master side amplifier to "Copy sending ON", and press the MODE key so that "COPY" is shown on the digital display and the sensor is in copy ready state. For the setting method, refer to "Operation guide".
- Turn off the master side amplifier.
- Connect the master side amplifier with the slave side amplifier as shown below.

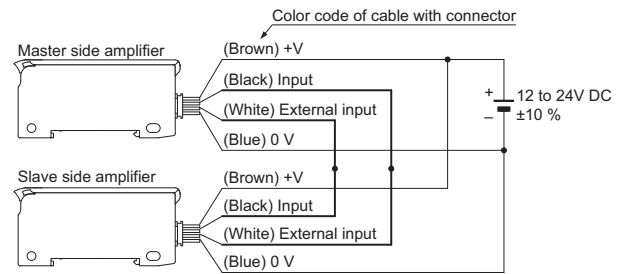

- Turn on the master side amplifier and the slave side amplifier at the same time. (Note)
- "COPY" is shown on the green digital display of the master side amplifier and 4-digit code is shown on the red digital display of it, then the copying starts. During copy communication, "COPY" is shown on the green digital display of the slave side amplifier, and the ongoing copy communication indicator ("!" → "!!" → "!!!" → "!!!!" → "!!!!!" → "!!!!!!" → "!!!!!!!") is displayed on the red digital display.
- When the copying is completed, "Good" is shown on the green digital display of the slave side amplifier, while the 4-digit code (the same code as the master side amplifier) is shown on the red digital display of it.
- Turn off the power of the master side amplifier and the slave side amplifier and disconnect the wire.

* If copying the settings to another amplifier repeatedly, follow the steps ③ to ⑦.

Note: Take care that if the power is not turned on at the same time, the setting contents may not be copied.

<To cancel the setting copy mode of the master side amplifier>

- While the slave side amplifier is disconnected, turn on the power of the master side amplifier.
- Press the MODE key for 2 sec. approx.

PRECAUTIONS FOR PROPER USE

Refer to the "Operation Guide" on our website for details pertaining to operating instructions for the amplifier.

Others

- Our products have been developed / produced for industrial use only.
- Do not use during the initial transient time (0.5 sec.) after the power supply is switched on.
- Take care that the product is not directly exposed to fluorescent lamp from a rapid-starter lamp, a high frequency lighting device or sunlight etc., as it may affect the sensing performance.
- This product is suitable for indoor use only.
- Avoid dust, dirt, and steam.
- Take care that the product does not come in contact with oil, grease, organic solvents, such as thinner, etc., strong acid or alkaline.
- This product cannot be used in an environment containing inflammable or explosive gases.
- Never disassemble or modify this product.
- EEPROM is adopted to this product. It is not possible to conduct teaching 100 thousand times or more, because of the EEPROM's lifetime.

Quick setting function

- The quick setting function makes it possible to set the content of the SET Mode (output operation, timer operation, amount of light emitted, and frequency of light emitted) simply by selecting a setting number.
- While in the RUN Mode, pressing and holding both the ON key (ON) and OFF key (OFF) simultaneously for 2 seconds will switch to the quick setting function.

<Table of quick setting numbers>

No.	Output operation	Timer	Emission amount setting
-00-	D-ON	non	Level 3 (OFF)
-01-	D-ON	non	Level 2 (ON)
-02-	D-ON	ofd 10 ms	Level 3 (OFF)
-03-	D-ON	ofd 10 ms	Level 2 (ON)
-04-	D-ON	ofd 40 ms	Level 3 (OFF)
-05-	D-ON	ofd 40 ms	Level 2 (ON)
-06-	D-ON	ond 10 ms	Level 3 (OFF)
-07-	D-ON	ond 10 ms	Level 2 (ON)
-08-	D-ON	ond 40 ms	Level 3 (OFF)
-09-	D-ON	ond 40 ms	Level 2 (ON)
-10-	L-ON	ond 40 ms	Level 2 (ON)
-11-	L-ON	ond 40 ms	Level 3 (OFF)
-12-	L-ON	ond 10 ms	Level 2 (ON)
-13-	L-ON	ond 10 ms	Level 3 (OFF)
-14-	L-ON	ofd 40 ms	Level 2 (ON)
-15-	L-ON	ofd 40 ms	Level 3 (OFF)
-16-	L-ON	ofd 10 ms	Level 2 (ON)
-17-	L-ON	ofd 10 ms	Level 3 (OFF)
-18-	L-ON	non	Level 2 (ON)
-19-	L-ON	non	Level 3 (OFF)

Code setting function

- The code setting function makes it possible to set the output operation, timer operation, amount of light emitted, frequency of light emitted, ECO setting, external input, and amount of shift by selecting a code of one's choice.
- While in the RUN Mode, pressing and holding both the ON key (ON) and OFF key (OFF) simultaneously for 4 seconds will switch to the code setting function.

<Code table>

Code	1st digit		2nd digit		ECO	External input	Shift (Note 1)			
	Output operation	Timer (Note 1)	Emission frequency							
			FX-101□	FX-102□						
0	D-ON	non	Level 3 (OFF)	0	1	OFF	Emission halt	5 %		
1		ond 10 ms		1			2	Limit teaching [+]	10 %	
2		ond 40 ms		2			3	Limit teaching [-]	15 %	
3		ofd 10 ms		3			4	Full-auto teaching	20 %	
4	ofd 40 ms			0	1		ECO	25 %		
5	L-ON	non	Level 2 (ON)	1	2	ON	Emission halt	30 %		
6		ond 10 ms					2	3	Limit teaching [+]	35 %
7		ond 40 ms					3	4	Limit teaching [-]	40 %
8		ofd 10 ms					0	1	Full-auto teaching	45 %
9	ofd 40 ms			1	2		ECO	50 %		
A	Auto		Level 1	2	3	OFF	2-point teaching			
B							3		4	Incident light intensity test
C				0	1		ON		2-point teaching	
D									1	2
E	2	3								
F	3	4								

Notes: 1) When the present setting is out of the code setting range, "-" is shown. When "-" is selected, the set content of the digit is not changed.
2) The factory setting is "0002".

New product introduction

Tough Fiber

Fiber Selection Guide

Choose by model

Choose by shape/application

Viewing new models

Fibers

Super Quality

Threaded Type

Cylindrical Type

Sleeve

Flat Type

Small Spot

Narroe Beam

Wide Beam

Convergent Reflective Type

Retroreflective Type

Chemical-resistant

Heat-resistant

Vacuum-resistant

Liquid Leak / Liquid Detection

Fiber Options

Fiber Dimensions

Thru-beam Type

Retroreflective Type

Reflective Type

Others

Amplifiers

FX-500 series

FX-100 series

INDEX

Earlier models comparison table

DIMENSIONS (Unit: mm in)

The CAD data in the dimensions can be downloaded from our website.

FX-101□ FX-102□ Amplifier

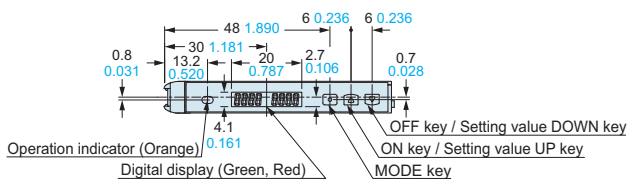

FX-101(P)-Z FX-102(P)-Z Amplifier

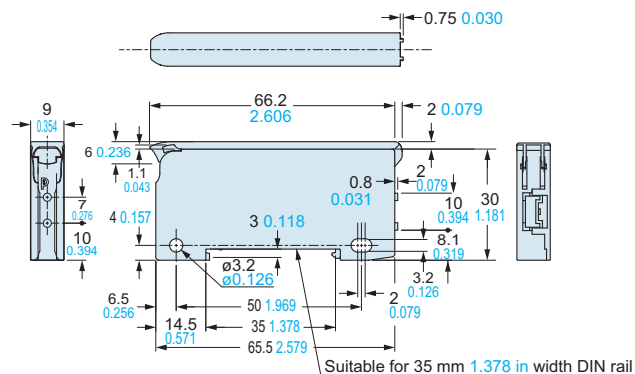
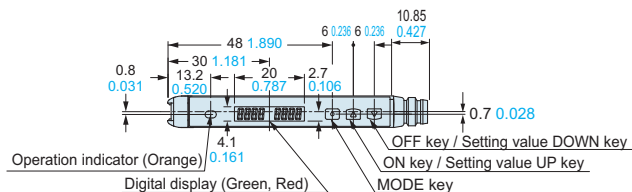

Note: The protection cover has been attached from the production at July, 2011.

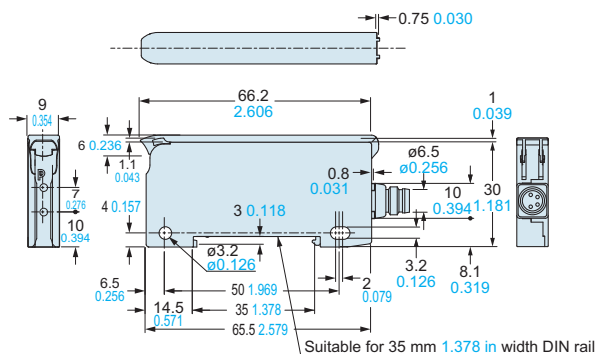

Note: The protection cover has been attached from the production at July, 2011.

MS-DIN-4 Amplifier mounting bracket (Optional)

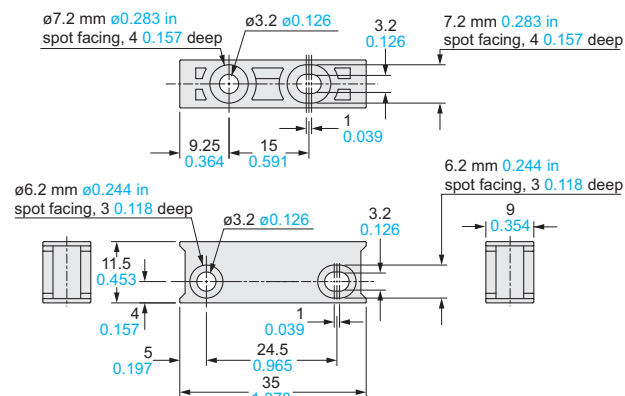

MS-DIN-E End plate (Optional)

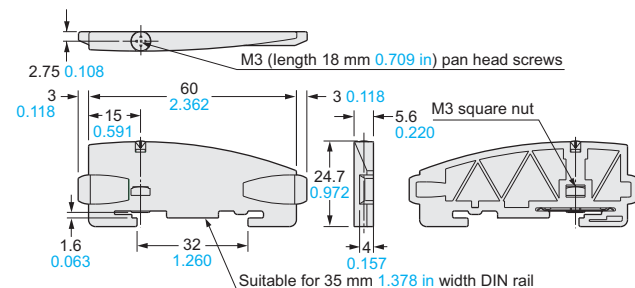

CN-14A-C□ CN-14A-R-C□ Connector attached cable (Optional)

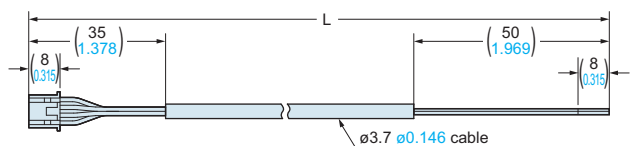

CN-14A-C2 is attached FX-101(P)-CC2 / FX-102(P)-CC2

• Length L

Model No.	Length L
CN-14A(-R)-C1	1,000 39.370
CN-14A(-R)-C2	2,000 78.740
CN-14A(-R)-C3	3,000 118.110
CN-14A(-R)-C5	5,000 196.850

INDEX

C			
CN-14A	FX-100 Connector	P.68	
CN-14A-C1	FX-100 Connector Attached Cable	P.68/P.74	
CN-14A-C2			
CN-14A-C3			
CN-14A-C5			
CN-14A-R-C1			
CN-14A-R-C2	FX-100 Connector Attached Cable (Flexible)		
CN-14A-R-C3			
CN-14A-R-C5			
CN-71-C1		P.58/P.64	
CN-71-C2			
CN-71-C5			
CN-72-C1			
CN-72-C2			
CN-72-C5			FX-500 Quick-connection Cable
CN-73-C1			
CN-73-C2			
CN-73-C5			
CN-74-C1			
CN-74-C2			
CN-74-C5			

F		
FB-1	Fiber Bender	P.14/P.33/P.51
FC-FX-1	FX-100 Protection Cover	P.68
FD-30	Super Quality Fiber	P.9/P.42
FD-31	Threaded Type Fiber	P.11/P.42
FD-31W		
FD-32G	Threaded /	P.11/P.18/P.42
FD-32GX	Small Spot Type Fiber	
FD-40	Super Quality Fiber	P.9/P.42
FD-41	Threaded Type Fiber	P.11/P.42
FD-41S	Sleeve Fiber	P.15/P.42
FD-41SW		
FD-41W	Threaded Type Fiber	P.11/P.42
FD-42G	Threaded /	P.11/P.18/P.43
FD-42GW	Small Spot Type Fiber	
FD-60	Super Quality Fiber	P.9/P.43
FD-61	Threaded Type Fiber	P.11/P.43
FD-61G		
FD-61S	Sleeve Fiber	P.15/P.43
FD-61W		
FD-62	Threaded Type Fiber	P.11/P.43
FD-64X		P.11/P.44
FD-A16	Wide Beam Fiber	P.20/P.44
FD-AL11		
FD-E13	Cylindrical / Sleeve Fiber	P.13/P.15/P.44
FD-E23		
FD-EG30	Threaded /	P.11/P.18/P.44
FD-EG30S	Small Spot Type Fiber	
FD-EG31	Sleeve Fiber	P.15/P.45
FD-EG31	Threaded /	P.11/P.18/P.45
FD-EG31	Small Spot Type Fiber	
FD-F4	Liquid Leak / Liquid Detection Fiber	P.28/P.45
FD-F41		
FD-F41Y		
FD-F71		
FD-F8Y		
FD-FA93		

FD-G40	Metal-free Fiber	P.10/Website		
FD-G60				
FD-H13-FM2				
FD-H18-L31	Heat-resistant Fiber	P.25/P.46		
FD-H20-21				
FD-H20-M1				
FD-H25-L43				
FD-H25-L45				
FD-H30-KZ1V	Vacuum-resistant Fiber	P.27/P.32		
FD-H30-KZ1V-S		P.26/P.47		
FD-H30-L32	Heat-resistant Fiber	P.25/P.47		
FD-H30-L32V		P.27/P.32		
FD-H30-L32V-S	Vacuum-resistant Fiber	P.26/P.47		
FD-H35-20S	Heat-resistant Fiber	P.25/P.47		
FD-H35-M2				
FD-H35-M2S6				
FD-HF40Y	Liquid Leak / Liquid Detection Fiber	P.28/P.47		
FD-L10	Convergent Reflective Type Fiber	P.21/P.48		
FD-L11				
FD-L12W				
FD-L20H				
FD-L21				
FD-L21W				
FD-L22A				
FD-L23				
FD-L30A				
FD-L31A				
FD-L32H			P.21/P.49	
FD-R60			Threaded Type Fiber	P.11/P.49
FD-S21			Cylindrical Fiber	P.13/P.49
FD-S30			Super Quality Fiber	P.9/P.49
FD-S31			Cylindrical Fiber	P.13/P.49
FD-S32				
FD-S32W				
FD-S33GW				
FD-V30	Sleeve Fiber	P.15/P.50		
FD-V30W				
FD-V50				
FD-WZ4	Flat Type Fiber	P.17/P.50		
FD-WZ7				
FD-Z20HBW				
FD-Z40HBW				
FD-Z50HW	Narrow Beam Fiber	P.19/P.50		
FDP-1000	Protective Tube (For Reflective Type Fiber)	P.33/P.51		
FDP-1500				
FDP-N1000				
FDP-N1500				
FDP-N500				
FR-KZ22E	Narrow Beam / Retroreflective Type Fiber	P.19/P.22/P.41		
FR-KZ50E				
FR-KZ50H				
FR-Z50HW				
FT-140	Threaded Type Fiber	P.10/P.34		
FT-30	Super Quality Fiber	P.9/P.34		
FT-31	Threaded Type Fiber	P.10/P.34		
FT-31S	Sleeve Fiber	P.15/P.34		
FT-31W	Threaded Type Fiber	P.10/P.34		
FT-40	Super Quality Fiber	P.9/P.34		
FT-41	Metal-free Fiber	P.10/Website		
FT-42	Threaded Type Fiber	P.10/P.34		
FT-42S	Sleeve Fiber	P.15/P.34		

New product
introductionTough
FiberFiber
Selection
GuideChoose
by modelChoose
by shape/
applicationViewing
new models

Fibers

Super
QualityThreaded
TypeCylindrical
Type

Sleeve

Flat
TypeSmall
SpotNarrow
BeamWide
BeamConvergent
Reflective
TypeRetroreflective
TypeChemical-
resistantHeat-
resistantVacuum-
resistantLiquid Leak /
Liquid DetectionFiber
OptionsFiber
DimensionsThru-beam
TypeRetroreflective
TypeReflective
Type

Others

Amplifiers

FX-500
seriesFX-100
series

INDEX

Earlier models
comparison
table

INDEX

FT-42W		P.10/P.34
FT-43	Threaded Type Fiber	
FT-45X		P.10/P.35
FT-A11		
FT-A11W		
FT-A32	Wide Beam Fiber	P.20/P.35
FT-A32W		
FT-AL05		
FT-E13	Cylindrical / Sleeve Fiber	P.12/P.15/P.35
FT-E23		
FT-F93	Liquid Leak / Liquid Detection Fiber	P.28/P.35
FT-H13-FM2		P.24/P.35
FT-H20-J20		P.25/P.32
FT-H20-J20-S		P.24/P.36
FT-H20-J30		P.25/P.32
FT-H20-J30-S		P.24/P.36
FT-H20-J50		P.25/P.32
FT-H20-J50-S	Heat-resistant Fiber	P.24/P.36
FT-H20-M1		
FT-H20-VJ50		P.25/P.32
FT-H20-VJ50-S		P.24/P.36
FT-H20-VJ80		P.25/P.32
FT-H20-VJ80-S		
FT-H20W-M1		P.24/P.36
FT-H30-M1V	Vacuum-resistant Fiber	P.27/P.32
FT-H30-M1V-S		P.26/P.36
FT-H35-M2	Heat-resistant Fiber	P.24/P.36
FT-H35-M2S6		
FT-HL80Y	Chemical-resistant Fiber	P.23/P.36
FT-J8	Fiber for Atmospheric Side	P.27/P.32/P.51
FT-KS40		
FT-KV26	Narrow Beam Fiber	P.19/P.37
FT-KV40		
FT-KV40W		
FT-L80Y	Chemical-resistant Fiber	P.23/P.37
FT-R40		
FT-R41W	Threaded Type Fiber	P.10/P.37
FT-R42W		
FT-S11	Cylindrical Fiber	P.12/P.37
FT-S20	Super Quality Fiber	P.9/P.38
FT-S21	Cylindrical Fiber	P.12/P.38
FT-S21W		
FT-S30	Super Quality Fiber	P.9/P.38
FT-S31W	Cylindrical Fiber	P.12/P.38
FT-S32		
FT-V23		
FT-V24W	Sleeve Fiber	P.15/P.38
FT-V25		
FT-V30		
FT-V40	Cylindrical Fiber	P.12/P.39
FT-V80Y	Chemical-resistant Fiber	P.23/P.39
FT-WZ4		
FT-WZ7		
FT-Z20HBW		
FT-Z30		P.16/P.39
FT-Z30E	Flat Type Fiber	
FT-Z30EW		
FT-Z30H		
FT-Z30HW		
FT-Z30W		P.16/P.40
FT-Z40HBW		
FT-Z802Y	Chemical-resistant Fiber	P.23/P.40

FTP-1000		
FTP-1500		
FTP-500	Protective Tube (For Thru-beam Type Fiber)	P.33/P.51
FTP-N1000		
FTP-N1500		
FTP-N500		
FV-BR1	Photo-terminal for Vacuum-resistant Fiber	P.27/P.32/P.51
FV-LE1	Vacuum-resistant Expansion Lens	P.27/P.31/P.51
FV-SV2	Vacuum-resistant Side-view Lens	
FX-101		
FX-101-CC2		
FX-101P		
FX-101P-CC2		
FX-102		
FX-102-CC2		
FX-102P	Digital Fiber Sensor	P.68/P.74
FX-102P-CC2		
FX-501		
FX-501P		
FX-502		
FX-502P		
FX-505-C2		
FX-505P-C2		
FX-AT15A	Fiber Single-core Holder	P.33
FX-AT2		
FX-AT3		
FX-AT4	Fiber Attachment	P.32/P.52
FX-AT5		
FX-AT6		
FX-CT1		P.32
FX-CT2	Fiber Cutter	P.32/P.52
FX-CT3		P.32
FX-LE1	Lens for Thru-beam Type Fiber	P.30/P.52
FX-LE2		
FX-MB1	FX-500 Fiber Amplifier Protection Seal	P.59
FX-MR1		
FX-MR2		P.18/P.32/P.52
FX-MR3	Lens for Reflective Type Fiber	
FX-MR5		
FX-MR6		P.18/P.32/P.53
FX-SV1	Side-view Lens for Thru-beam Type Fiber	P.31/P.53

M

MS-AJ1-F	Universal Sensor Mounting Stand	P.33
MS-AJ2-F		
MS-DIN-2	FX-500 Amplifier Mounting Bracket	P.59/P.64
MS-DIN-4	FX-100 Amplifier Mounting Bracket	P.68/P.74
MS-DIN-E	End Plate	P.58/P.64/P.68/ P.74
MS-EX3	FX-MR2 Mounting Bracket	P.53
MS-FD-2		
	Fiber Mounting Bracket	P.27/P.32/P.53
MS-FD-3		P.53
MS-FD-F7-1	FD-F71 SUS Mounting Bracket	P.29
MS-FD-F7-2	FD-F71 PVC Mounting Bracket	
MS-FX-01Y	Liquid Inflow Prevention Joint	
MS-FX-02Y	Protective Tube Extension Joint	
MS-FX-03Y	Fiber Mounting Joint	P.29/P.33
MS-FX-YF	Joint Internal Ferrulre	

New product
introductionTough
FiberFiber
Selection
GuideChoose
by modelChoose
by shape/
applicationViewing
new models

Fibers

Super
QualityThreaded
TypeCylindrical
Type

Sleeve

Flat
TypeSmall
SpotNarrow
BeamWide
BeamConvergent
Reflective
TypeRetroreflective
TypeChemical-
resistantHeat-
resistantVacuum-
resistantLiquid Leak /
Liquid DetectionFiber
OptionsFiber
DimensionsThru-beam
TypeRetroreflective
TypeReflective
Type

Others

Amplifiers

FX-500
seriesFX-100
series

INDEX

Earlier models
comparison
table

INDEX

R

RF-003	FR-KZ50E/KZ50H Exclusive Reflector	P.32/P.53
RF-13	Reflective Tape	P.32
RF-210	Reflector	P.22/P.33/P.54
RF-220		
RF-230		

S

SC-SU1	Copy Unit	P.68
---------------	-----------	------

New product
introduction

Tough
Fiber

Fiber
Selection
Guide

Choose
by model

Choose
by shape/
application

Viewing
new models

Fibers

Super
Quality

Threaded
Type

Cylindrical
Type

Sleeve

Flat
Type

Small
Spot

Narrow
Beam

Wide
Beam

Convergent
Reflective
Type

Retroreflective
Type

Chemical-
resistant

Heat-
resistant

Vacuum-
resistant

Liquid Leak/
Liquid Detection

Fiber
Options

Fiber
Dimensions

Thru-beam
Type

Retroreflective
Type

Reflective
Type

Others

Amplifiers

FX-500
series

FX-100
series

INDEX

Earlier models
comparison
table









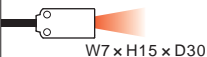

Earlier Models Comparison Table

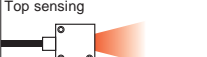
Advantages of switching to recommended replacements

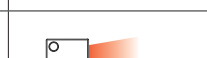
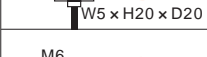
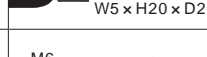
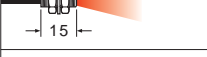
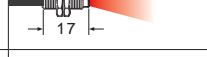
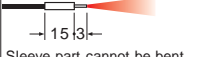
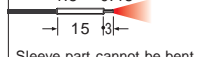
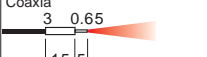
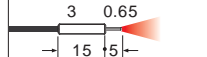
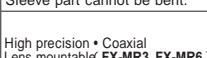
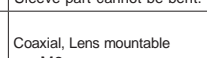
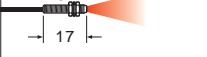
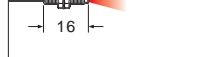

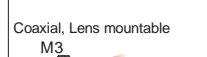
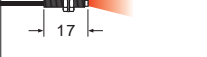
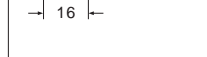

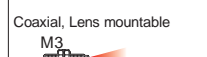

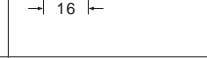

- The quality of many models has been improved by shortening their bending radii and achieving better bending performance.
- The number of part numbers has been reduced, letting you reduce the part numbers to keep track of and service parts to keep on hand.
- We have reduced our environmental impact further by making fiber end bracket out of stainless steel and plastic, which contain no RoHS substances.

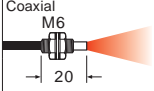
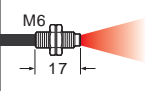
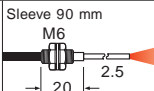
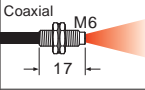
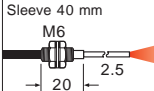
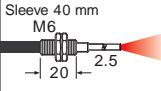
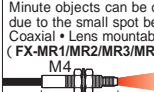
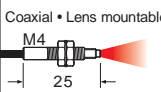
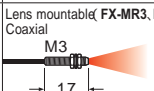
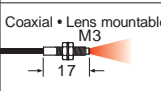
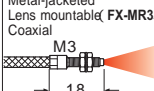
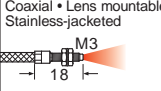
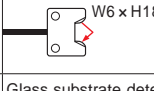
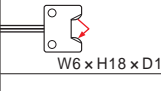
Subjected models

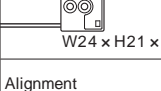
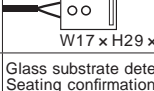
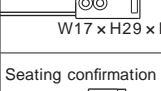
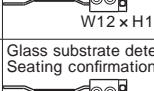
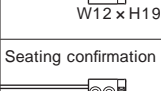
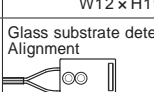
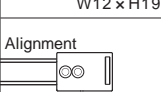
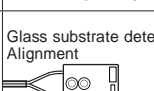
Discontinued models Stopping taking order date : 31 Mar., 2012

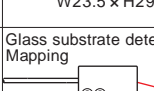
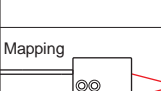
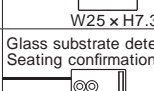
Type	Discontinued models					Recommended replacements					Main points of difference from discontinued models
	Model No.	Shape of fiber head (mm)	Bending radius (mm)	Bending durability	Sensing range FX-500 STD (mm in)	Model No.	Shape of fiber head (mm)	Bending radius (mm)	Bending durability	Sensing range FX-500 STD (mm in)	
Reflective type	FD-A15	 W7 x H15 x D30	R25	-	200 7.874	FD-A16	 W7 x H15 x D30	R4	-	200 7.874	
	FD-AFM2	 W5 x H20 x D20	R25	-	280 11.024	FD-AL11	 W5 x H20 x D20	R2	-	320 12.598	• Cable lead out orientation changed • Metal case material (brass) Changed to plastic (PPS)
	FD-AFM2E	 W5 x H20 x D20	R25	-	280 11.024	FD-AL11	 W5 x H20 x D20	R2	-	320 12.598	• Cable lead out orientation changed • Metal casing material (brass) Changed to plastic (PPS)
	FD-B8	 M6 15	R25	-	490 19.291	FD-62	 M6 17	R4	-	520 20.472	• End bracket total length for the M6 part only: 15 mm Changed to 17 mm (M6 part/15 mm + ø4.5 area/2 mm)
	FD-E12	 1.5 0.5 15 Sleeve part cannot be bent.	R10	-	12 0.472	FD-E13	 1.5 0.48 15 Sleeve part cannot be bent.	R4	-	12 0.472	• Split amplifier insertion section configuration Changed to integrated light emitting/receiving configuration
	FD-E22	 Coaxia 3 0.65 15 Sleeve part cannot be bent.	R25	-	55 2.165	FD-E23	 3 0.65 15 Sleeve part cannot be bent.	R4	-	55 2.165	• Split amplifier insertion section configuration Changed to integrated light emitting/receiving configuration
	FD-EG1	 High precision • Coaxial Lens mountable (FX-MR3, FX-MR6) M3 17	R25	-	40 1.575	FD-EG30	 Coaxial, Lens mountable M3 16	R4	-	48 1.890	• Split amplifier insertion section configuration Changed to integrated light emitting / receiving configuration • End bracket total length 17 mm Changed to 16 mm
	FD-EG2	 High precision • Coaxial Lens mountable (FX-MR3, FX-MR6) Light emitting fiber element 0.175 M3 17	R10	-	24 0.945	FD-EG31	 Coaxial, Lens mountable M3 16	R4	-	20 0.787	• Split amplifier insertion section configuration Changed to integrated light emitting/receiving configuration • End bracket total length 17 mm Changed to 16 mm • Protective tube outside diameter ø1.6 Changed to ø1.2
	FD-EG3	 High precision • Coaxial Lens mountable (FX-MR3, FX-MR6) Light emitting fiber element 0.125 M3 17	R10	-	20 0.787	FD-EG31	 Coaxial, Lens mountable M3 16	R4	-	20 0.787	• Split amplifier insertion section configuration Changed to integrated light emitting/receiving configuration • End bracket total length 17 mm Changed to 16 mm • Protective tube outside diameter ø1.6 Changed to ø1.2
	FD-EN500S1	 M3 0.5 15 Sleeve part cannot be bent.	R25	-	-	FD-EG30S	 Sleeve 15 mm M3 0.8 15 Sleeve part cannot be bent.	R4	-	50 1.969	• Split amplifier insertion section configuration Changed to integrated light emitting /receiving configuration • Sleeve size ø0.5 Changed to ø0.8
	FD-ENM1S1	 Coaxial M3 0.8 15 Sleeve part cannot be bent.	R25	-	50 1.969	FD-EG30S	 Sleeve 15 mm M3 0.8 15 Sleeve part cannot be bent.	R4	-	50 1.969	• Split amplifier insertion section configuration Changed to integrated light emitting/receiving configuration
	FD-F705	 SEMI S2 compliant W20 x H30 x D10	R4 (Protective tube R20)	-	Liquid leak detection	FD-F71	 SEMI S2 compliant W20 x H30 x D10	R4 (Protective tube R20)	-	Liquid leak detection	
	FD-FA90	 Mountable on pipe • Array fiber W6.5 x H28.3 x D17	R10	-	Liquid detection	FD-FA93	 Array fiber W6.5 x H28.3 x D17	R4	-	Liquid detection	

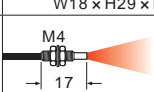
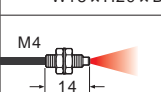
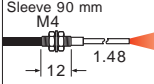
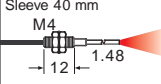
Earlier Models Comparison Table

Type	Discontinued models				Recommended replacements				Main points of difference from discontinued models		
	Model No.	Shape of fiber head (mm)	Bending radius (mm)	Bending durability	Sensing range FX-500 STD (mm in)	Model No.	Shape of fiber head (mm)	Bending radius (mm)		Bending durability	Sensing range FX-500 STD (mm in)
Reflective type	FD-FM2		R25	-	420 16.535	Tough FD-61		R4	-	450 17.717	<ul style="list-style-type: none"> End bracket total length of 20 mm for the (M6 part/15 mm + ϕ3.5 area/5 mm) Changed to 17 mm (M6 part/15 mm + ϕ4.5 area/2 mm) Coaxial cable used for wiring Changed to parallel type
	FD-FM2S		R25 (Sleeve R10)	-	380 14.961	Tough FD-61G		R4	-	420 16.535	<ul style="list-style-type: none"> End bracket total length of 20 mm for the (M6 part/15 mm + ϕ3.5 area/5 mm) Changed to 17 mm (M6 part/15 mm + ϕ4.5 area/2 mm)
	FD-FM2S4		R25 (Sleeve R10)	-	380 14.961	Tough FD-61S		R4 (Sleeve R10)	-	420 16.535	<ul style="list-style-type: none"> The sleeve length 90 mm type supports semi-custom products.
	FD-G4		R25	-	140 5.512	Tough FD-42G		R2	-	200 7.874	
	FD-G6		R25	-	140 5.512	Tough FD-32G		R2	-	200 7.874	
	FD-G6X		R25	-	170 6.693	FD-32GX		R2	-	200 7.874	<ul style="list-style-type: none"> Stainless steel mesh jacket covering the stainless steel spiral tube used as a protective cover for the fiber Changed to plastic (polyolefin)
	FD-L4		R25	-	15.5 0.610	Tough FD-L20H		R2	-	23 0.906	
	FD-L41		R10	-	1.5 to 16 0.059 to 0.630	Tough FD-L21		R2	-	1.5 to 16 0.059 to 0.630	
	FD-L43		R4	-	0 to 24 0 to 0.945	Tough FD-L22A		R2	-	0 to 24 0 to 0.945	
	FD-L44		R10	-	0 to 9.5 0 to 0.374	Tough FD-L11		R4	-	0 to 9.5 0 to 0.374	
	FD-L44S		R10	-	0 to 5 0 to 0.197	Tough FD-L10		R4	-	0 to 5 0 to 0.197	
	FD-L45		R4	-	0 to 40 0 to 1.575	Tough FD-L30A		R4	-	0 to 43 0 to 1.693	
	FD-L45A		R25	-	4 to 44 0.157 to 1.732	Tough FD-L31A		R4	-	4 to 33 0.157 to 1.299	<ul style="list-style-type: none"> Previous no flexing distance specifications Specification wording changed to state flexing \pm2 degrees (Reference: Discontinued model \pm2 degrees specification is 10 mm to 32 mm)
	FD-L46		R25	-	1 to 56 0.039 to 2.205	FD-L32H		R4	-	0 to 56 0 to 2.205	
	FD-L47		R4	-	0 to 29 0 to 1.142	Tough FD-L23		R2	-	0 to 29 0 to 1.142	
	FD-NFM2		R25	-	120 4.724	Tough FD-41		R2	-	125 4.921	<ul style="list-style-type: none"> End bracket total length of 17 mm for the (M4 part/12 mm + ϕ2.5 area/5 mm) Changed to 14 mm (M4 part/12 mm + ϕ2.5 area/2 mm)
FD-NFM2S		R25 (Sleeve R10)	-	120 4.724	Tough FD-41S		R2 (Sleeve R10)	-	125 4.921	<ul style="list-style-type: none"> The sleeve length 90 mm type supports semi-custom products. 	

New product introduction

Tough Fiber

Fiber Selection Guide

Choose by model

Choose by shape/application

Viewing new models

Fibers

Super Quality

Threaded Type

Cylindrical Type

Sleeve

Flat Type

Small Spot

Narrow Beam

Wide Beam

Convergent Reflective Type

Retroreflective Type

Chemical-resistant

Heat-resistant

Vacuum-resistant

Liquid Leak / Liquid Detection

Fiber Options

Fiber Dimensions

Thru-beam Type

Retroreflective Type

Reflective Type

Others

Amplifiers

FX-500 series

FX-100 series

INDEX

Earlier models comparison table

Earlier Models Comparison Table

Type	Discontinued models					Recommended replacements					Main points of difference from discontinued models
	Model No.	Shape of fiber head (mm)	Bending radius (mm)	Bending durability	Sensing range FX-500 STD (mm in)	Model No.	Shape of fiber head (mm)	Bending radius (mm)	Bending durability	Sensing range FX-500 STD (mm in)	
Reflective type	FD-NFM2S4	Sleeve 40 mm M4 12 1.48	R25 (Sleeve R10)	-	120 4.724	Tough FD-41S	Sleeve 40 mm M4 12 1.48	R2 (Sleeve R10)	-	125 4.921	
	FD-P2	1.5 15	R4	-	80 3.150	Tough FD-S21	1.5 10	R2	-	80 3.150	<ul style="list-style-type: none"> Split amplifier insertion section configuration Changed to integrated light emitting/receiving configuration End bracket total length 15 mm Changed to 10 mm PVC outer covering material for fiber Changed to PE
	FD-P40	M3 12	R4	-	45 1.772	Tough FD-31	M3 12	R2	-	125 4.921	<ul style="list-style-type: none"> End bracket shape is 12 mm for the M3 part only Changed to a total length of 12 mm (M3 part/10 mm + $\phi 2$ area/2 mm) PVC outer covering material for fiber Changed to PE
	FD-P50	3 15	R4	-	120 4.724	Tough FD-S32	3 15	R4	-	420 16.535	<ul style="list-style-type: none"> PVC outer covering material for fiber Changed to PE
	FD-P60	15 M4	R4	-	120 4.724	Tough FD-41	M4 14	R2	-	125 4.921	<ul style="list-style-type: none"> End bracket total length of 15 mm for the (M4 part/12 mm + $\phi 3$ area/3 mm) Changed to 14 mm (M4 part/12 mm + $\phi 2.5$ area/2 mm) PVC outer covering material for fiber Changed to PE
	FD-P80	M6 15	R4	-	280 11.024	Tough FD-61	M6 17	R4	-	450 17.717	<ul style="list-style-type: none"> End bracket total length of 15 mm for the M6 part only Changed to 17 mm (M6 part/15 mm + $\phi 4.5$ area/2 mm) PVC outer covering material for fiber Changed to PE
	FD-P81X	Metal-jacketed M6 15	R10	-	270 10.630	FD-64X	Stainless-jacketed M6 22	R4	-	280 11.024	<ul style="list-style-type: none"> End bracket total length of 19 mm for the (M6 part/15 mm + crimped area/4 mm) Changed to 22 mm ($\phi 4.5$ area/2 mm + M6 part/15 mm + crimped area/5 mm) Split amplifier insertion section configuration Changed to integrated light emitting/receiving configuration Stainless steel mesh jacket covering the stainless steel spiral tube used as a protective cover for the fiber Changed to plastic (polyolefin)
	FD-R80	15 M6	R25	-	220 8.661	Tough FD-R60	15 M6	R4	-	290 11.417	
	FD-S80	3 15	R25	-	380 14.961	Tough FD-S32	3 15	R4	-	420 16.535	
	FD-SFM2SV2	15 20 5 2 Sleeve part cannot be bent.	R25	-	120 4.724	Tough FD-V50	15 20 5 2 Sleeve part cannot be bent.	R4	-	120 4.724	<ul style="list-style-type: none"> From sleeve end to optical axis center position is 0.8 mm Changed to 2.3 mm A D-shaped surface that makes it easy to align with the optical axis has been added
	FD-SNFM2	2.5 8	R25	-	120 4.724	Tough FD-S31	M3 10	R2	-	125 4.921	<ul style="list-style-type: none"> End bracket shape is 8 mm for the $\phi 2.5$ part only Changed to 10 mm ($\phi 3$ part/ 8 mm + $\phi 2$ area/2 mm)
	FD-T40	M3 12	R25	-	120 4.724	Tough FD-31	M3 12	R2	-	125 4.921	<ul style="list-style-type: none"> End bracket shape is 12 mm for the M3 part only Changed to a total length of 12 mm (M3 part/10 mm + $\phi 2$ area/2 mm)
	FD-T80	M4 12	R25	-	380 14.961	Tough FD-61	M6 17	R4	-	450 17.717	<ul style="list-style-type: none"> End bracket shape is 12 mm for the M4 part only Changed to a total length of 17 mm (M6 part/15 mm + $\phi 4.5$ area/2 mm) Fiber cable outside diameter $\phi 1.3$ Changed to $\phi 2.2$
	FD-V41	15 10 3 1.5 Small diameter Sleeve part cannot be bent.	R25	-	65 2.559	Tough FD-V30	Small diameter 15 15 3 1.5 Sleeve part cannot be bent.	R2	-	65 2.559	<ul style="list-style-type: none"> From sleeve end to optical axis center position is 0.7 mm Changed to 2 mm End sleeve length of 10 mm Changed to 15 mm

New product introduction
Tough Fiber

Fiber Selection Guide
Choose by model
Choose by shape/application
Viewing new models

Fibers
Super Quality
Threaded Type
Cylindrical Type
Sleeve
Flat Type
Small Spot
Narrow Beam
Wide Beam
Convergent Reflective Type
Retroreflective Type
Chemical-resistant
Heat-resistant
Vacuum-resistant
Liquid Leak/Liquid Detection

Fiber Options

Fiber Dimensions
Thru-beam Type
Retroreflective Type
Reflective Type
Others

Amplifiers
FX-500 series
FX-100 series

INDEX

Earlier models comparison table

Earlier Models Comparison Table

Type	Discontinued models					Recommended replacements					Main points of difference from discontinued models
	Model No.	Shape of fiber head (mm)	Bending radius (mm)	Bending durability	Sensing range FX-500 STD (mm/in)	Model No.	Shape of fiber head (mm)	Bending radius (mm)	Bending durability	Sensing range FX-500 STD (mm/in)	
Reflective type	FD-W44		R1 (Sleeve R10)	-	80 3.150	Tough FD-41S		R2 (Sleeve R10)	-	125 4.921	
	FD-W8		R1	-	250 9.843	FD-41SW		R1 (Sleeve R10)	-	80 3.150	
	FD-WG4	 Minute objects can be detected due to the small spot beam. Coaxial • Lens mountable (FX-MR1/MR2/MR3/MR5/MR6)	R2	-	150 5.906	Tough FD-61		R4	-	450 17.717	•End bracket total length is 15 mm for the M6 part only Changed to 17 mm (M6 part/ 15 mm + ø4.5 area/2 mm)
	FD-WKZ1	 Long sensing range • Rectangular head	R1	-	20 to 490 0.787 to 19.291	FD-61W		R1	-	270 10.630	•End bracket total length is 15 mm for the M6 part only Changed to 17 mm (M6 part/ 15 mm + ø4.5 area/2 mm)
	FD-WL41	 Glass substrate detection	R1	-	2.5 to 14 0.098 to 0.551	Tough FD-42G	 Coaxial • Lens mountable	R2	-	200 7.874	
	FD-WL48		R1	-	7.5 0.295	FD-42GW	 Coaxial • Lens mountable	R1	-	150 5.906	
	FD-WS8		R1	-	250 9.843	FD-Z50HW		R1	-	10 to 650 0.394 to 25.591	•Stainless steel unit casing material Changed to plastic (PC)
	FD-WSG4		R2	-	150 5.906	Tough FD-L21		R2	-	1.5 to 16 0.059 to 0.630	
	FD-WT4		R1	-	80 3.150	FD-L21W		R1	-	3 to 14 0.118 to 0.551	
	FD-WT8		R1	-	250 9.843	FD-L12W		R1	-	8 0.315	
	FD-WV42	 Sleeve part cannot be bent.	R1	-	16 0.630	Tough FD-S32		R4	-	420 16.535	
						FD-S32W		R1	-	270 10.630	
						FD-S33GW		R1	-	150 5.906	
						Tough FD-31		R2	-	125 4.921	•End bracket total length is 12 mm for the M3 part only Changed to 12 mm (M3 part/ 10 mm + ø2 area/2 mm)
					FD-31W		R1	-	80 3.150	•End bracket total length is 12 mm for the M3 part only Changed to 12 mm (M3 part/ 10 mm + ø2 area/2 mm)	
					Tough FD-41		R2	-	125 4.921	•End bracket total length is 12 mm for the M4 part only Changed to 14 mm (M4 part/12 mm + ø3 area/2 mm)	
					FD-41W		R1	-	270 10.630	•End bracket total length is 12 mm for the M4 part only Changed to 14 mm (M4 part/12 mm + ø3 area/2 mm)	
					Tough FD-V30	 Sleeve part cannot be bent.	R2	-	65 2.559	•From sleeve end to optical axis center position is 1 mm Changed to 2 mm •End sleeve thickness of ø2 Changed to ø1.5 •A D-shaped surface that makes it easy to align with the optical axis has been added	
					FD-V30W	 Sleeve part cannot be bent.	R1	-	20 0.787	•From sleeve end to optical axis center position is 1 mm Changed to 2 mm •End sleeve thickness of ø2 Changed to ø1.5 •A D-shaped surface that makes it easy to align with the optical axis has been added	

New product introduction

Tough Fiber

Fiber Selection Guide

Choose by model

Choose by shape/application

Viewing new models

Fibers

Super Quality

Threaded Type

Cylindrical Type

Sleeve

Flat Type

Small Spot

Narrow Beam

Wide Beam

Convergent Reflective Type

Retroreflective Type

Chemical-resistant

Heat-resistant

Vacuum-resistant

Liquid Leak / Liquid Detection

Fiber Options

Fiber Dimensions

Thru-beam Type

Retroreflective Type

Reflective Type

Others

Amplifiers







FX-500 series

FX-100 series

INDEX

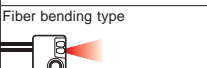
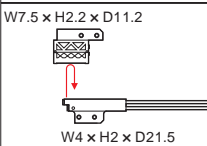
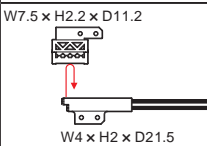
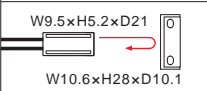
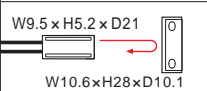
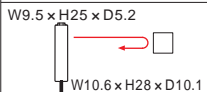
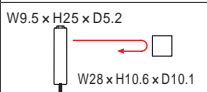
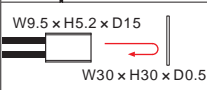
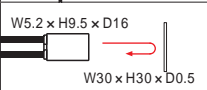
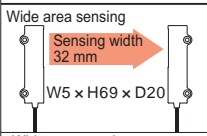
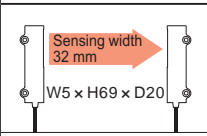
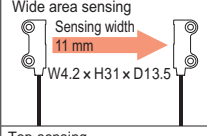
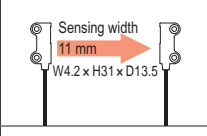
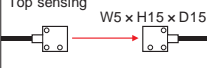
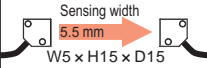
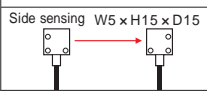
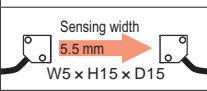
Earlier models comparison table

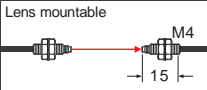
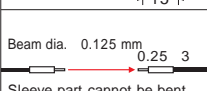
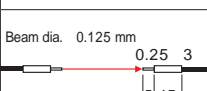
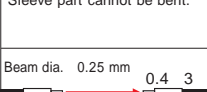
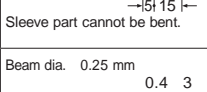
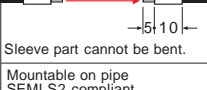
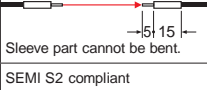
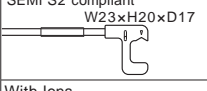
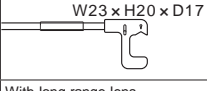
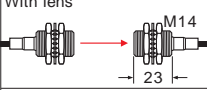
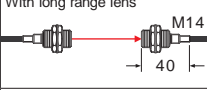
Earlier Models Comparison Table

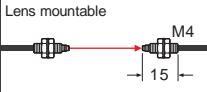
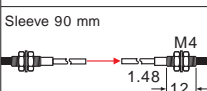
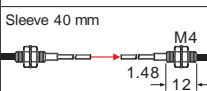
Type	Discontinued models					Recommended replacements					Main points of difference from discontinued models
	Model No.	Shape of fiber head (mm)	Bending radius (mm)	Bending durability	Sensing range FX-500 STD (mm in)	Model No.	Shape of fiber head (mm)	Bending radius (mm)	Bending durability	Sensing range FX-500 STD (mm in)	
Reflective type	FD-WZ4HB	Fiber bending type  W2 x H10 x D10	R1	-	2.5 to 65 0.098 to 2.559	FD-Z20HBW	Fiber bending type  W2 x H10 x D10	R1	-	2 to 85 0.079 to 3.346	
	FD-WZ7HB	Fiber bending type  W3.5 x H14 x D11	R1	-	1 to 150 0.039 to 5.906	FD-Z40HBW	Fiber bending type  W3.5 x H14 x D11	R1	-	260 10.236	
Retroreflective type	FR-KV1	 W7.5 x H2.2 x D11.2	R10	-	20 to 310 0.787 to 12.205	FR-KZ22E	 W7.5 x H2.2 x D11.2	R2	-	15 to 310 0.591 to 12.205	• Unit side installation screw positions have been moved back 1 mm from the front edge
	FR-KZ21	 W9.5 x H5.2 x D21	R10	-	20 to 200 0.787 to 7.874	FR-KZ50H	 W9.5 x H5.2 x D21	R2	-	20 to 300 0.787 to 11.811	
	FR-KZ21E	 W9.5 x H25 x D5.2	R10	-	20 to 200 0.787 to 7.874	FR-KZ50E	 W9.5 x H25 x D5.2	R2	-	20 to 300 0.787 to 11.811	
	FR-WKZ11	 W9.5 x H5.2 x D15	R1	-	100 to 990 3.937 to 38.976	FR-Z50HW	 W5.2 x H9.5 x D16	R1	-	100 to 990 3.937 to 38.976	
	FT-A30	Wide area sensing Sensing width 32 mm  W5 x H69 x D20	R10	-	3600 141.732	FT-A32	Wide area sensing Sensing width 32 mm  W5 x H69 x D20	R2	-	3600 141.732	• Fiber cable outside diameter ø2.2 Changed to ø1.3 • Optical cable diameter of 3 x 32 Changed to 3.2 x 32
FT-A8	Wide area sensing Sensing width 11 mm  W4.2 x H31 x D13.5	R10	-	3600 141.732	FT-A11	Wide area sensing Sensing width 11 mm  W4.2 x H31 x D13.5	R2	-	3600 141.732	• Fiber cable outside diameter ø2.2 Changed to ø1.3	
FT-AFM2	Top sensing  W5 x H15 x D15	R25	-	860 33.858	FT-AL05	Top sensing Sensing width 5.5 mm  W5 x H15 x D15	R2	-	860 33.858	• Cable lead out orientation changed • Metal casing material (brass) Changed to plastic (PPS)	
FT-AFM2E	Side sensing  W5 x H15 x D15	R25	-	860 33.858	FT-AL05	Side sensing Sensing width 5.5 mm  W5 x H15 x D15	R2	-	860 33.858	• Cable lead out direction changed • Metal casing material (brass) Changed to plastic (PPS)	
FT-B8	Lens mountable (FX-LE1/LE2/SV1)  M4	R25	-	1250 49.213	FT-43	Lens mountable  M4	R4	-	1400 55.118		
FT-E12	Beam dia. 0.125 mm Sleeve part cannot be bent.  0.25 3	R5	-	-	FT-E13	Beam dia. 0.125 mm Sleeve part cannot be bent.  0.25 3	R2	-	15 0.591	• Fiber length 500 mm /set length type Changed to fiber length 1 m/free cut type • Fiber cable outside diameter ø1.2 Changed to ø1 • End bracket length of 10 mm Changed to 15 mm	
FT-E22	Beam dia. 0.25 mm Sleeve part cannot be bent.  0.4 3	R5	-	-	FT-E23	Beam dia. 0.25 mm Sleeve part cannot be bent.  0.4 3	R2	-	75 2.953	• Set length type Changed to free cut type • Fiber cable outside diameter ø1.2 Changed to ø1 • End bracket length of 10 mm Changed to 15 mm	
FT-F902	Mountable on pipe SEMI S2 compliant  W23 x H20 x D17	R4 (Protective tube R20)	-	Liquid detection	FT-F93	SEMI S2 compliant  W23 x H20 x D17	R2 (Protective tube R20)	-	Liquid detection		
FT-FM10L	With lens  M14	R25	-	19600 771.654	FT-140	With long range lens  M14	R4	-	19600 771.654		
FT-FM2	Lens mountable (FX-LE1/LE2/SV1)  M4	R25	-	1100 43.307	FT-42	Lens mountable  M4	R4	-	1130 44.488		
FT-FM2S	Sleeve 90 mm  M4	R25 (Sleeve R10)	-	1100 43.307	FT-42S	Sleeve 40 mm  M4	R4 (Sleeve R10)	-	1130 44.488	• The sleeve length 90 mm type supports semi-custom products.	
FT-FM2S4	Sleeve 40 mm  M4	R25 (Sleeve R10)	-	1100 43.307	FT-42S	Sleeve 40 mm  M4	R4 (Sleeve R10)	-	1130 44.488		

Earlier Models Comparison Table

Type	Discontinued models				
	Model No.	Shape of fiber head (mm)	Bending radius (mm)	Bending durability	Sensing range FX-500 STD (mm/in)
Thru-beam type	FT-K8		R25	-	3600 141.732
	FT-KV1	W2 x H1.5 x D20 	R10	-	540 21.260
	FT-KV8	Side-view type with small light dispersion 	R25	-	3600 141.732
	FT-NFM2		R25	-	310 12.205
	FT-NFM2S	Sleeve 90 mm 	R25 (Sleeve R10)	-	310 12.205
	FT-NFM2S4	Sleeve 40 mm 	R25 (Sleeve R10)	-	310 12.205
	FT-P2		R4	-	330 12.992
	FT-P40		R4	-	160 6.299
	FT-P60	Lens mountable (FX-LE1/LE2/SV1) M4 	R4	-	350 13.780
	FT-P80	Lens mountable (FX-LE1/LE2/SV1) M4 	R4	-	810 31.890
	FT-P81X	Lens mountable (FX-LE1/LE2/SV1) Metal-jacketed M4 	R10	-	880 34.646
	FT-PS1		R4	-	90 3.543
	FT-R80	Lens mountable (FX-LE1/LE2) M4 	R25	-	780 30.709
	FT-SFM2		R25	-	1100 43.307
	FT-SFM2L	Long sensing range • with lens 	R25	-	2600 102.362
	FT-SFM2SV2	 Sleeve part cannot be bent.	R25	-	570 22.441
FT-SNFM2		R25	-	310 12.205	
FT-T80	Lens mountable (FX-LE1/SV1) M3 	R25	-	1100 43.307	
FT-V10		R25	-	3500 137.795	

Type	Recommended replacements				
	Model No.	Shape of fiber head (mm)	Bending radius (mm)	Bending durability	Sensing range FX-500 STD (mm/in)
Thru-beam type	Tough FT-KS40		R2	-	3600 141.732
	Tough FT-KV26	1.5x2 	R2	-	710 27.953
	Tough FT-KV40		R2	-	3600 141.732
	Tough FT-31		R2	-	315 12.402
	Tough FT-31S	Sleeve 40 mm 	R2 (Sleeve R10)	-	315 12.402
	Tough FT-31S	Sleeve 40 mm 	R2 (Sleeve R10)	-	315 12.402
	Tough FT-S21		R2	-	315 12.402
	Tough FT-31		R2	-	315 12.402
	Tough FT-42	Lens mountable M4 	R4	-	1130 44.488
	Tough FT-42	Lens mountable M4 	R4	-	1130 44.488
	FT-45X	Lens mountable • Stainless-jacketed M4 	R4	-	1200 47.244
	Tough FT-S11		R2	-	90 3.543
	Tough FT-R40	Lens mountable M4 	R4	-	930 36.614
	FT-S32	Long sensing range • with lens 	R10	-	3100 122.047
	FT-S32	Long sensing range • with lens 	R10	-	3100 122.047
	Tough FT-V30	 Sleeve part cannot be bent.	R4	-	680 26.772
Tough FT-S21		R2	-	315 12.402	
Tough FT-42	Lens mountable M4 	R4	-	1130 44.488	
Tough FT-V40		R4	-	3500 137.795	

Main points of difference from discontinued models

• Fiber cable outside diameter $\phi 2.2$
Changed to $\phi 1$

• Fiber cable outside diameter $\phi 2.2$
Changed to $\phi 1$
• Metal end material (stainless steel)
Changed to plastic (LCP), set screw
fastening specifications Changed to
MS-FD-3 fastener specifications

• End bracket total length of 15 mm for
the (M3 part/10 mm + $\phi 2$ area/5 mm)
Changed to 12 mm (M3 part/10 mm
+ $\phi 2$ area/2 mm)

• The sleeve length 90 mm type
supports semi-custom products.

• Fiber length 1 m/Set length type
Changed to fiber length 2 m/free cut type
• Fiber exterior cover material of PVC
Changed to PE

• End bracket total length of 10 mm for
the M3 part Changed to 12 mm (M3
part/10 mm + $\phi 2$ area/2 mm)
• Fiber exterior cover material of PVC
Changed to PE

• Fiber exterior cover material of
PVC Changed to PE
• Fiber cable outside diameter $\phi 1.25$
Changed to $\phi 2.2$

• Fiber exterior cover material of
PVC Changed to PE

• Stainless steel mesh jacket covering
the stainless steel spiral tube used as
a protective cover for the fiber
Changed to plastic (polyolefin)

• End bracket total length of 14 mm for
the (M2.6 part/3 mm + M4 part/11 mm)
Changed to 15 mm (M2.6 part/3
mm + M4 part/12 mm)

• Optical cable diameter of $\phi 1$
Changed to $\phi 2.2$

• From sleeve end to optical axis center
position is 0.8 Changed to 1.3 mm
• D-shaped surface that makes it easy to
align with the optical axis has been added

• End bracket total length of $\phi 1.5/8$
mm Changed to 12 mm ($\phi 1$
area/2 mm + $\phi 1.5/8$ mm)

• End bracket total length of 12.5 mm for
the (M2.6 part/2.5 mm + M3 part/10
mm) Changed to 15 mm (M2.6 part
/3 mm + M4 part/12 mm)
• Fiber cable outside diameter $\phi 1.3$
Changed to $\phi 2.2$

New product introduction

Tough Fiber

Fiber Selection Guide

Choose by model

Choose by shape/application

Viewing new models

Fibers

Super Quality

Threaded

Cylindrical Type

Sleeve

Flat Type

Small Spot

Narrow Beam

Wide Beam

Convergent Reflective Type

Retroreflective Type

Chemical-resistant

Heat-resistant

Vacuum-resistant

Liquid Leak / Liquid Detection

Fiber Options

Fiber Dimensions

Thru-beam Type

Retroreflective Type

Reflective Type

Others

Amplifiers

FX-500 series

FX-100 series

INDEX

Earlier models comparison table

Earlier Models Comparison Table

Type	Discontinued models					Recommended replacements					
	Model No.	Shape of fiber head (mm)	Bending radius (mm)	Bending durability	Sensing range FX-500 STD (mm in)	Model No.	Shape of fiber head (mm)	Bending radius (mm)	Bending durability	Sensing range FX-500 STD (mm in)	Main points of difference from discontinued models
Thru-beam type	FT-V22		R25	-	300 11.811	Tough FT-V23		R4	-	450 17.717	<ul style="list-style-type: none"> Fiber length 1 m/Set length type Changed to fiber length 2 m/free cut type From sleeve end to optical axis center position is 0.6 Changed to 1.1 mm D-shaped surface that makes it easy to align with the optical axis has been added
	FT-V41		R25	-	200 7.874	Tough FT-V25		R2	-	240 9.449	<ul style="list-style-type: none"> End bracket outside diameter of $\phi 2.5$ Changed to $\phi 2$ From sleeve end to optical axis center position is 0.6 Changed to 1 mm
	FT-W4		R1	-	250 9.843	FT-31		R2	-	315 12.402	<ul style="list-style-type: none"> End bracket total length of 15 mm for the (M3 part/10 mm + crimped area/5 mm) Changed to 12 mm ($\phi 2$ area/2 mm + M3 part/10 mm) Fiber cable outside diameter $\phi 2.2$ Changed to $\phi 1$
	FT-W8		R10	-	790 31.102	FT-31W		R1	-	260 10.236	<ul style="list-style-type: none"> End bracket total length of 15 mm for the (M3 part/10 mm + crimped area/5 mm) Changed to 12 mm ($\phi 2$ area/2 mm + M3 part/10 mm) Fiber cable outside diameter $\phi 2.2$ Changed to $\phi 1$
	FT-WA30		R1	-	3600 141.732	Tough FT-42		R4	-	1130 44.488	
	FT-WA8		R1	-	3600 141.732	FT-42W		R1	-	800 31.496	
	FT-WK8		R1	-	3600 141.732	Tough FT-A32		R2	-	3600 141.732	<ul style="list-style-type: none"> Fiber cable outside diameter $\phi 2.2$ Changed to $\phi 1.3$ Optical cable diameter of 3 x 32 Changed to 3.2 x 32
	FT-WR80		R1	-	660 25.984	FT-A32W		R1	-	3600 141.732	<ul style="list-style-type: none"> Fiber cable outside diameter $\phi 2.2$ Changed to $\phi 1.3$ Optical cable diameter of 3 x 32 Changed to 3.2 x 32
	FT-WR80L		R1	-	2200 86.614	FT-A11		R2	-	3600 141.732	<ul style="list-style-type: none"> Fiber cable outside diameter $\phi 2.2$ Changed to $\phi 1.3$
	FT-WS3		R1	-	790 31.102	FT-A11W		R1	-	3600 141.732	<ul style="list-style-type: none"> Fiber cable outside diameter $\phi 2.2$ Changed to $\phi 1.3$
						Tough FT-KV40		R2	-	3600 141.732	<ul style="list-style-type: none"> Fiber cable outside diameter $\phi 2.2$ Changed to $\phi 1$ Metal end material (stainless steel) Changed to plastic (LCP), set screw fastening specifications Changed to MS-FD-3 fastener specifications
						FT-KV40W		R1	-	3600 141.732	<ul style="list-style-type: none"> Fiber cable outside diameter $\phi 2.2$ Changed to $\phi 1$ Metal end material (stainless steel) Changed to plastic (LCP), set screw fastening specifications Changed to MS-FD-3 fastener specifications
					FT-R41W		R1	-	800 31.496		
					FT-R42W		R1	-	2200 86.614		
					FT-S31W		R1	-	800 31.496	<ul style="list-style-type: none"> End bracket total length of 15 mm Changed to 10 mm 	

Earlier Models Comparison Table

Type	Discontinued models					Recommended replacements					Main points of difference from discontinued models
	Model No.	Shape of fiber head (mm)	Bending radius (mm)	Bending durability	Sensing range FX-500 STD (mm/in)	Model No.	Shape of fiber head (mm)	Bending radius (mm)	Bending durability	Sensing range FX-500 STD (mm/in)	
Thru-beam type	FT-WS4		R1	-	250 9.843	Tough FT-S21		R2	-	315 12.402	•End bracket shape of $\phi 1.5/8$ mm Changed to 10 mm ($\phi 1$ part/2 mm + $\phi 1.5$ part/8 mm)
	FT-WS8		R1	-	790 31.102	FT-S21W		R1	-	260 10.236	•End bracket shape of $\phi 1.5/8$ mm Changed to 10 mm ($\phi 1$ part/2 mm + $\phi 1.5$ part/8 mm)
	FT-WS8L	Long sensing range • with lens 	R1	-	3300 129.921	FT-S31W		R1	-	800 31.496	•End bracket shape of $\phi 2.5/8$ mm Changed to 10 mm ($\phi 2$ part/2 mm + $\phi 3$ part/8 mm)
	FT-WV42		R1	-	100 3.937	FT-S32	Long sensing range • with lens 	R10	-	3100 122.047	•End bracket shape of $\phi 3$ Changed to 10 mm •Bending radius of 1 mm Changed to 10 mm
	FT-WZ4HB	Fiber bending type W2 x H10 x D10 	R1	-	210 8.268	Tough FT-V25		R2	-	240 9.449	•D-shaped surface that makes it easy to align with the optical axis has been added
	FT-WZ7HB	Fiber bending type W3.5 x H14 x D11 	R1	-	790 31.102	FT-V24W		R1	-	110 4.331	•D-shaped surface that makes it easy to align with the optical axis has been added
	FT-WZ8	Top sensing W8.5 x H12 x D3 	R1	-	1300 51.181	FT-Z20HBW	Fiber bending type W2 x H10 x D10 	R1	-	260 10.236	
	FT-WZ8E	Side sensing W3 x H12 x D8 	R1	-	3400 133.858	FT-Z40HBW	Fiber bending type W3.5 x H14 x D11 	R1	-	800 31.496	
	FT-WZ8H	Top sensing W3 x H8 x D12 	R1	-	3300 129.921	Tough FT-Z30	Top sensing W8.5 x H12 x D3 	R2	-	2100 82.677	•Black casing color Changed to translucent, protective seal eliminated
	FT-Z8	Top sensing W8.5 x H12 x D3 	R4	-	1200 47.244	FT-Z30W	Top sensing W8.5 x H12 x D3 	R1	-	1500 59.055	•Black casing color Changed to translucent, protective seal eliminated
	FT-Z8E	Side sensing W3 x H12 x D8 	R4	-	2000 78.740	Tough FT-Z30E	Side sensing W3 x H12 x D8 	R2	-	3500 137.795	
	FT-Z8H	Top sensing W3 x H8 x D12 	R4	-	2100 82.677	FT-Z30EW	Side sensing W3 x H12 x D8 	R1	-	3400 133.858	
						Tough FT-Z30H	Top sensing W3 x H8 x D12 	R2	-	3500 137.795	
						FT-Z30HW	Top sensing W3 x H8 x D12 	R1	-	3500 137.795	
						Tough FT-Z30	Top sensing W8.5 x H12 x D3 	R2	-	2100 82.677	•Black casing color Changed to translucent, protective seal eliminated
					Tough FT-Z30E	Side sensing W3 x H12 x D8 	R2	-	3500 137.795		
					Tough FT-Z30H	Top sensing W3 x H8 x D12 	R2	-	3500 137.795		

New product introduction

Tough Fiber

Fiber Selection Guide

Choose by model

Choose by shape/application

Viewing new models

Fibers

Super Quality

Threaded Type

Cylindrical Type

Sleeve

Flat Type

Small Spot

Narrow Beam

Wide Beam

Convergent Reflective Type

Retroreflective Type

Chemical-resistant

Heat-resistant

Vacuum-resistant

Liquid Leak / Liquid Detection

Fiber Options

Fiber Dimensions

Thru-beam Type

Retroreflective Type

Reflective Type

Others

Amplifiers

FX-500 series

FX-100 series

INDEX

Earlier models comparison table

MEMO



New Product

Communication Unit for Open Network

SC-GU3 SERIES

The digital sensor can be connected directly to the 3 types of open network!

Other types of analog input sensors can also be connected!

CC-Link
SC-GU3-01



DeviceNet
SC-GU3-02



EtherCAT
SC-GU3-03



Scattered digital sensors can be centrally managed and set through an open network.

Applicable
Digital Sensor

Digital Fiber Sensor
FX-501 FX-502

Digital Laser Sensor
LS-403

Digital Pressure Sensor
DPS-401 DPS-402

Please contact

Panasonic Electric Works SUNX Co., Ltd.

2431-1 Ushiyama-cho, Kasugai-shi, Aichi, 486-0901, Japan

■ Telephone: +81-568-33-7211 ■ Facsimile: +81-568-33-2631

Global Sales & Marketing Division

■ Telephone: +81-568-33-7861 ■ Facsimile: +81-568-33-8591

panasonic-electric-works.net/sunx

Panasonic[®]

All Rights Reserved © Panasonic Electric Works SUNX Co., Ltd. 2011