

Panasonic

ideas for life

NEW

Compact
Laser Displacement Sensor

HL-G1 SERIES

CE
Conforming to
EMC Directive

FDA



Introducing the new standard in CMOS laser displacement sensors

This single instrument delivers both high-precision measurement and computer-driven data analysis.

High resolution of 0.5 μm 0.02 mil
Fast response Sampling rate 200 μs



GLOBAL SUPPORT

Each model's interface supports not only Japanese and English, but also Chinese and Korean, providing a new level of support for devices and equipment in use worldwide.

HL-G1 SERIES

Introducing Panasonic Electric Works SUNX

Panasonic brand starts from 2010/10/1

Thanks to high-precision measurement at a resolution of 0.5 μm 0.02 mil and an LED digital display that provides exceptional ease of use, the HL-G1 series will see use in a variety of applications on production lines worldwide.

High performance CMOS Laser Displacement Sensors

HL-G112

- Measurement center distance: 120 mm **4.724 in**
- Measurement range: ± 60 mm **± 2.362 in**
- Resolution: 8 μm **0.315 mil**

HL-G108

- Measurement center distance: 85 mm **3.346 in**
- Measurement range: ± 20 mm **± 0.787 in**
- Resolution: 2.5 μm **0.098 mil**



HL-G105

- Measurement center distance: 50 mm **1.969 in**
- Measurement range: ± 10 mm **± 0.394 in**
- Resolution: 1.5 μm **0.059 mil**

HL-G103

- Measurement center distance: 30 mm **1.181 in**
- Measurement range: ± 4 mm **± 0.157 in**
- Resolution: 0.5 μm **0.02 mil**

Fast

Setup is fast and efficient by using the built-in digital display to set measurement parameters such as sampling cycle and output options.

Compact

The HL-G1 series features a compact design despite its built-in controller and digital readout. Thanks to our miniaturization technology, it can easily be installed on robot arms and in confined spaces.

User-friendly

The HL-G1 series now features a user-friendly interface that offers improved ease of use when operating via computer software or HMI unit for more sophisticated operation and analysis.

Fast

A variety of high-end functions are included in a

Easy configuration using the digital display

The built-in digital display makes it easy to configure sensor operation while checking displacement values.

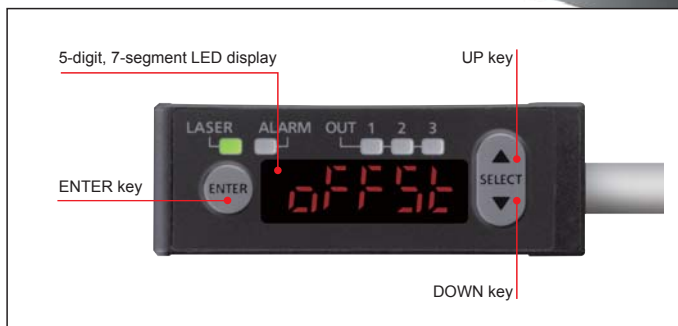

Easy to embed in machines and production lines thanks to a built-in controller

As a self contained sensor, the HL-G1 series offers a space saving configuration by removing the need for an external controller.

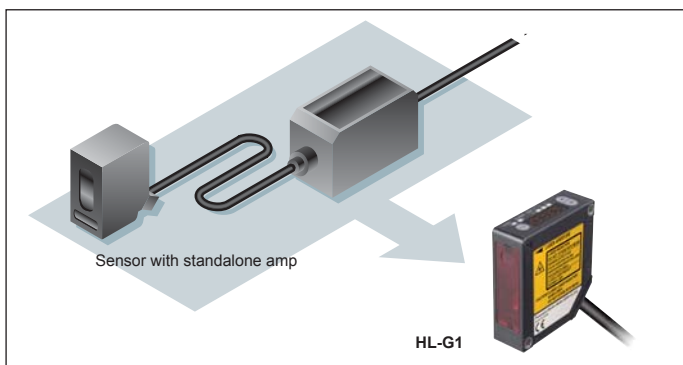

I/O to accommodate multiple needs

Timing input and multi input

In addition to timing input select the desired input according to your application:

- Zero set on/off
- Laser control
- Reset
- Teaching

Featuring 3 outputs and an analog 2 outputs

With three outputs, the HL-G1 can be used to generate HI/GO/LOW judgment output or alarm output. The analog output can be used in both current and voltage modes.

Compact

compact, self-contained body for exceptional ease of use.

Lightweight body that can be used on moving machinery

The sensor's lightweight plastic body, which weighs 70 g approx., can be installed on moving parts such as sliders and robot arms. The sensor ships standard with flexible cables.

IP67 dust- and water-proof protective enclosure

Thanks to its IP67-rated protective enclosure, the HL-G1 can be used in the presence of water and dust. Mounting holes are lined with metal sleeves, allowing the instrument to be tightened securely in place with up to 0.8 N•m of torque.



Compact size despite the built-in controller and digital readout



Fewer model numbers to register

Support for both NPN and PNP polarity

A single model number accommodates both NPN and PNP wiring polarity, reducing the number of model numbers that must be registered for maintenance purposes.



Smooth setup changes

Memory switching function

Up to four groups of sensor settings can be stored for fast recall. Easy switching among setting groups allows smooth setup changes.

User-friendly

Delivering a new level of ease of use thanks to a dedicated application and display unit

(High functionality type only)



Software tool for sensor configuration and evaluation

In addition to configuring up to 16 sensors at once, this free tool makes it easy to gather data needed for analysis, including received light waveform monitoring and data buffering. The interface language can be selected at the time of installation.



- **Data buffering**

Stores and displays measurement data. Data can be superimposed on past measurement data and displayed for easy comparison and analysis.

- **Received light waveform display**

Displays the amount of light received across all cells of the detector element.

- **Measured value display**

Displays measured values as well as the output state for all terminals.

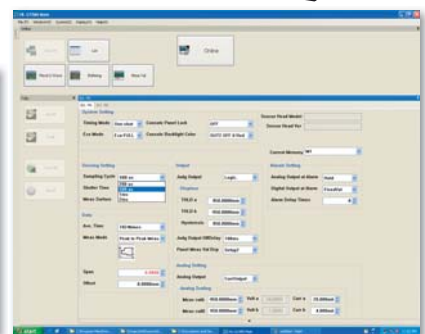
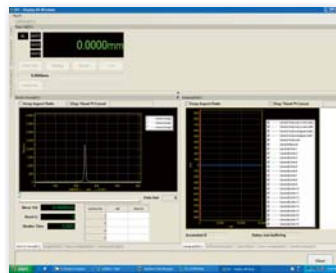

HMI screen for the HL-G1 series

The GT02 / GT12 HMI operator panel can be used in combination with the HL-G1 to allow easy confirmation of sensor status and configuration of sensor settings from a remote location. Japanese, English, Chinese, and Korean are supported. For more information about the GT series, see the Panasonic Electric Works SUNX website or a product catalog.

Select from the following HMI operator panels:

Power supply: 24 V
Communications port: RS422 (RS485)

- AIG02GQ 14D
- AIG02MQ 15D
- AIG12GQ 14D/15D
- AIG12MQ 14D/15D



Software is available for download.

URL: panasonic-electric-works.net/sunx

Sensor configuration and evaluation software tool, HMI screen data, function blocks, sample ladders, etc.

Terms of use

Panasonic Electric Works SUNX offers no warranty for this software and is not liable for any loss or damage suffered as a result of its use or operation, whether direct, indirect, incidental, consequential, or unforeseen.

Full Line-UP

Choose from four models according to your application.

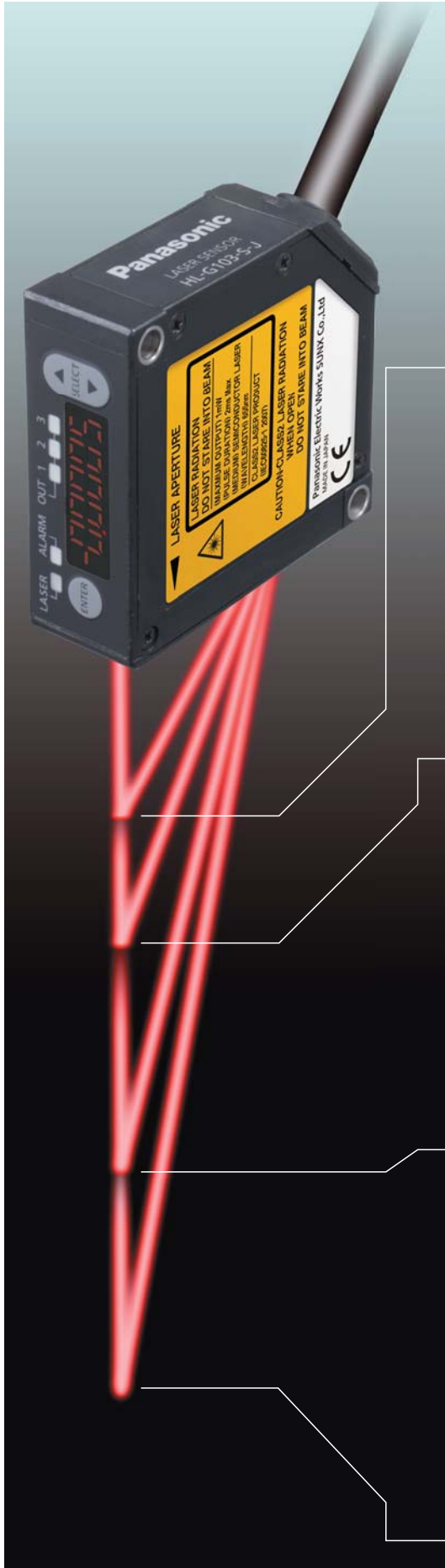

HL-G103□

Measurement range
30 mm ±4 mm
1.181 in ±0.157 in

Resolution
0.5 μm
0.02 mil

Linearity
±0.1 % F.S.

Beam diameter
0.1 × 0.1 mm
0.004 × 0.004 in

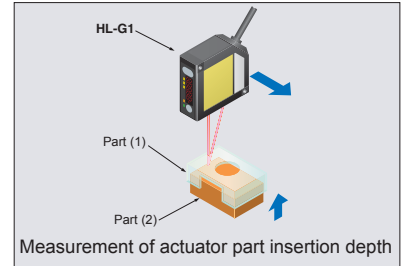
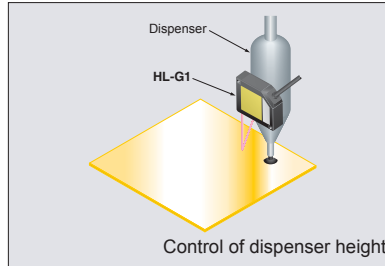

HL-G105□

Measurement range
50 mm ±10 mm
1.969 in ±0.394 in

Resolution
1.5 μm
0.059 mil

Linearity
±0.1 % F.S.

Beam diameter
0.5 × 0.1 mm
0.020 × 0.039 in

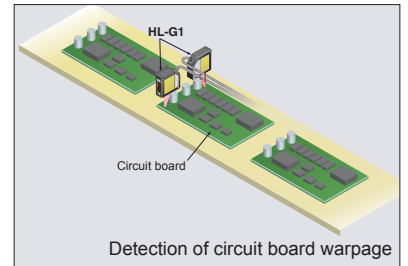
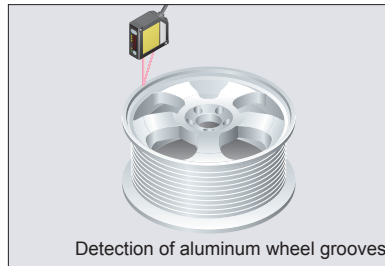

HL-G108□

Measurement range
85 mm ±20 mm
3.346 in ±0.787 in

Resolution
2.5 μm
0.098 mil

Linearity
±0.1 % F.S.

Beam diameter
0.75 × 1.25 mm
0.030 × 0.059 in

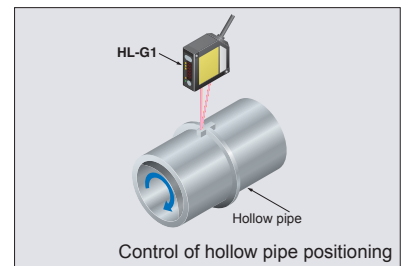
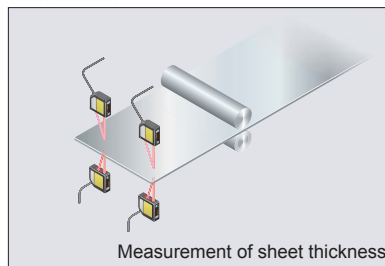

HL-G112□

Measurement range
120 mm ±60 mm
4.724 in ±2.362 in



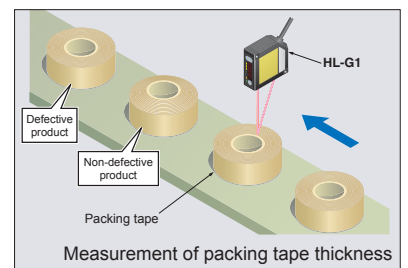
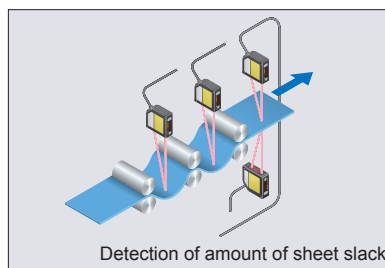

Resolution
8 μm
0.315 mil

Linearity
±0.1 % F.S.

Beam diameter
1.0 × 1.5 mm
0.039 × 0.059 in



ORDER GUIDE

Type	Appearance	Measurement center distance and measuring range	Resolution	Beam diameter	Model No.	Laser class
Standard type		30 ±4 mm 1.181 ±0.157 in	0.5 μm 0.020 mil	0.1 × 0.1 mm 0.004 × 0.004 in	HL-G103-A-C5	FDA: Class II IEC: Class 2
High functionality type					HL-G103-S-J	
Standard type		50 ±10 mm 1.969 ±0.394 in	1.5 μm 0.059 mil	0.5 × 1 mm 0.020 × 0.039 in	HL-G105-A-C5	
High functionality type					HL-G105-S-J	
Standard type		85 ±20 mm 3.346 ±0.787 in	2.5 μm 0.098 mil	0.75 × 1.25 mm 0.030 × 0.059 in	HL-G108-A-C5	
High functionality type					HL-G108-S-J	
Standard type		120 ±60 mm 4.724 ±2.362 in	8 μm 0.315 mil	1.0 × 1.5 mm 0.039 × 0.059 in	HL-G112-A-C5	
High functionality type					HL-G112-S-J	

OPTIONS

Type	Appearance	Model No.	Description
Extension cable (for High functionality type)		HL-G1CCJ2	Length: 2 m 6.562 ft, Weight: 130 g approx.
		HL-G1CCJ5	Length: 5 m 16.404 ft, Weight: 320 g approx.
		HL-G1CCJ10	Length: 10 m 32.808 ft, Weight: 630 g approx.
		HL-G1CCJ20	Length: 20 m 65.617 ft, Weight: 1300 g approx.
			14-core cabtyre cable with connector on both ends

OPERATING ENVIRONMENT OF SOFTWARE TOOL

Operating environment						
PC environment	PC/AT compatible					
OS	OS	32/64	Edition	Service Pack	NET	VisualStudio RunTime
	WindowsXP	32bit	Professional	SP2 or later	Unnecessary	VS2008 (necessary)
	WindowsVista Windows7		Enterprise	—		
CPU	Intel Pentium4 2 GHz or more, either equaling or surpassing					
Graphics	XGA (1024 × 768 256 colors) or more					
Memory	1 GB or more					
Hard disk	Free space 100 MB or more					
USB interface	USB 2.0 full speed (USB 1.1 compatible)					

* This software accommodates below language. You can select the language when installing.
 •Japanese •English •Korean •Chinese (upcoming)

INFORMATION OF INTERFACE CONVERTER

The communications interface converter of HL-G1 series is RS-422 or RS-485. We will recommend the following interface converter when connecting to PC by USB.

LINEEYE CO., LTD.
 Interface converter (USB to RS-422/485) SI-35USB
 Website: <http://www.lineeye.com>

SPECIFICATIONS

Type		Standard type			
Item	Model No.	HL-G103-A-C5	HL-G105-A-C5	HL-G108-A-C5	HL-G112-A-C5
Measurement center distance		30 mm 1.181 in	50 mm 1.969 in	85 mm 3.346 in	120 mm 4.724 in
Measuring range		±4 mm ±0.157 in	±10 mm ±0.394 in	±20 mm ±0.787 in	±60 mm ±2.362 in
Resolution		0.5 μm 0.020 mil	1.5 μm 0.059 mil	2.5 μm 0.098 mil	8 μm 0.315 mil
Linearity		±0.1 % F.S.			
Temperature characteristics		±0.08 % F.S. / °C			
Light source		Red semiconductor laser, Class 2 (IEC / JIS), Class II (FDA, Laser Notice No. 50) Max. output: 1 mW (Peak emission wavelength: 655 nm 0.026 mil)			
Beam diameter (Note 2)		0.1 × 0.1 mm 0.004 × 0.004 in	0.5 × 1 mm 0.020 × 0.039 in	0.75 × 1.25 mm 0.030 × 0.049 in	1.0 × 1.5 mm 0.039 × 0.059 in
Receiving element		CMOS image sensor			
Supply voltage		24 V DC ±10 % including ripple 0.5 V (P-P)			
Current consumption		100 mA or less			
Sampling rate		200 μs, 500 μs, 1 ms, 2 ms			
Analog output	Voltage	Output range: 0 to +10.5 V (normal), 11 V (alarm) Output impedance: 100 Ω			
	Current	Output range: 3.2 to 20.8 mA (normal), 21.6 mA (alarm) Load impedance: 300 Ω or less			
Output (OUT 1, OUT 2, OUT 3)		Judgment output or alarm output (Setting can be selected.) Selectable NPN transistor open-collector or PNP transistor open-collector			
		<In case of using NPN output>		<In case of using PNP output>	
		<ul style="list-style-type: none"> • Maximum sink current : 50 mA • Applied voltage : 3 to 24 V DC (between output and 0 V) • Residual voltage : 2 V or less (at 50 mA of sink current) 		<ul style="list-style-type: none"> • Maximum source current : 50 mA • Residual voltage : 2.8 V or less (at 50 mA of source current) 	
	Output operation	Opened when the amount of light is insufficient.			
	Short circuit protection	Incorporated (automatic restoration)			
Output polarity setting input		NPN open-collector output operates when 0 V is connected. PNP open-collector output operates when 24 V DC is connected.			
Timing input		NPN output operates when 0V is connected and NPN is set. (It depends on the setting.) PNP output operates when external power + is connected and PNP is set. (It depends on the setting.)			
Multi input		Zero set , zero set off, reset, teaching, and laser control according to the input time. In case NPN output is selected, Function varies according to the time 0 V is connected NPN. In case PNP output is selected, Function varies according to the time external power + is connected.			
Indicator	Laser emission	Green LED (lights up during laser emission).			
	Alarm	Orange LED lights up when this product cannot measure because of insufficient light intensity.			
	Measurement range	Three yellow LED			
Digital display		Red LED 5 digit display			
Environmental resistance	Protection	IP67			
	Ambient temperature	-10 to +45 °C +14 to +113 °F (No dew condensation), Storage: -20 to +60 °C -4 to +140 °F			
	Ambient humidity	35 to 85 % RH, Storage: 35 to 85 % RH			
	Ambient illuminance	Incandescent light: 3,000 lx or less at the light-receiving face (Note 3)			
	Ambient altitude	2,000 m 6561 ft or less			
	Pollution degree	2			
	Insulation resistance	20 MΩ, or more, with 250 V DC between all supply terminals connected together and enclosure			
	Voltage withstandability	1,000 V AC one min. between all supply terminals connected together and enclosure			
	Vibration resistance	10 to 55 Hz (period: 1 min.) frequency, 1.5 mm 0.059 in amplitude in X,Y and Z directions for two hours each			
Shock resistance	500 m/s ² acceleration (50 G approx.) in X,Y and Z directions for three times each				
Material		Enclosure: PBT, Front cover: Acrylic, Cable: PVC			
Cable		0.1 mm ² 10-core cable, 5 m 16.404 ft long			
Weight		Net weight: 70 g approx. (not including cable), 320 g approx. (including cable), Gross weight: 380 g approx.			
Accessory		Warning label: 1 set			

Notes: 1) Where measurement conditions have not been specified precisely, the conditions used were as follows: supply voltage 24 V DC, ambient temperature +20 °C **+68 °F**, sampling rate 500 μs, average number of samples: 1024, measurement center distance, object measured is made of white ceramic and digital measurement values.

2) This beam diameter is the size at the measurement center distance. These values were defined by using 1/e² (13.5 %) of the center light intensity. If there is a slight leakage of light outside the normal spot diameter and if the periphery surrounding the sensing point has a higher reflectivity than the sensing point itself, then the results may be affected.

3) The fluctuation by ambient illuminance is ±0.1 % F.S. or less.

SPECIFICATIONS

Type		High functionality type			
Item	Model No.	HL-G103-S-J	HL-G105-S-J	HL-G108-S-J	HL-G112-S-J
Measurement center distance		30 mm 1.181 in	50 mm 1.969 in	85 mm 3.346 in	120 mm 4.724 in
Measuring range		±4 mm ±0.157 in	±10 mm ±0.394 in	±20 mm ±0.787 in	±60 mm ±2.362 in
Resolution		0.5 μm 0.020 mil	1.5 μm 0.059 mil	2.5 μm 0.098 mil	8 μm 0.315 mil
Linearity		±0.1 % F.S.			
Temperature characteristics		±0.08 % F.S. / °C			
Light source		Red semiconductor laser, Class 2 (IEC / JIS), Class II (FDA, Laser Notice No. 50) Max. output: 1 mW (Peak emission wavelength: 655 nm 0.026 mil)			
Beam diameter (Note 2)		0.1 × 0.1 mm 0.004 × 0.004 in	0.5 × 1 mm 0.020 × 0.039 in	0.75 × 1.25 mm 0.030 × 0.049 in	1.0 × 1.5 mm 0.039 × 0.059 in
Receiving element		CMOS image sensor			
Supply voltage		24 V DC ±10 % including ripple 0.5 V (P-P)			
Current consumption		100 mA or less			
Sampling rate		200 μs, 500 μs, 1 ms, 2 ms			
Analogy output	Voltage	Output range: 0 to +10.5 V (normal), 11 V (alarm) Output impedance: 100 Ω			
	Current	Output range: 3.2 to 20.8 mA (normal), 21.6 mA (alarm) Load impedance: 300 Ω or less			
Output (OUT 1, OUT 2, OUT 3)		Judgment output or alarm output (Setting can be selected.) Selectable NPN transistor open-collector or PNP transistor open-collector			
		<In case of using NPN output>		<In case of using PNP output>	
		<ul style="list-style-type: none"> • Maximum sink current : 50 mA • Applied voltage : 3 to 24 V DC (between output and 0 V) • Residual voltage : 2 V or less (at 50 mA of sink current) 		<ul style="list-style-type: none"> • Maximum source current : 50 mA • Residual voltage : 2.8 V or less (at 50 mA of source current) 	
	Output operation	Opened when the amount of light is insufficient.			
	Short circuit protection	Incorporated (automatic restoration)			
Output polarity setting input		NPN open collector output operates when 0 V is connected. PNP open collector output operates when 24 V DC is connected.			
Timing input		NPN output operates when 0V is connected and NPN is set. (It depends on the setting.) PNP output operates when external power + is connected and PNP is set. (It depends on the setting.)			
Multi input		Zero set , zero set off, reset, teaching, and laser control according to the input time. In case NPN output is selected, Function varies according to the time 0 V is connected NPN. In case PNP output is selected, Function varies according to the time external power + is connected.			
Communications interface		RS-422 or RS-485 Baud rate: 9,600/19,200/38,400/115,200/230,400/460,800/921,600 bps Data length 8 bit, Stop bit length 1 bit, Without parity check, BCC check, Termination code: CR			
Indicator	Laser emission	Green LED (lights up during laser emission)			
	Alarm	Orange LED lights up when this product cannot measure because of insufficient light intensity.			
	Measurement range	Three yellow LED			
Digital display		Red LED 5 digit display			
Environmental resistance	Protection	IP67			
	Ambient temperature	-10 to +45 °C +14 to +113 °F (No dew condensation), Storage: -20 to +60 °C -4 to +140 °F			
	Ambient humidity	35 to 85 % RH, Storage: 35 to 85 % RH			
	Ambient illuminance	Incandescent light: 3,000 lx or less at the light-receiving face (Note 3)			
	Ambient altitude	2,000 m 6561 ft or less			
	Pollution degree	2			
	Insulation resistance	20 MΩ, or more, with 250 V DC between all supply terminals connected together and enclosure			
	Voltage withstandability	1,000 V AC one min. between all supply terminals connected together and enclosure			
Vibration resistance	10 to 55 Hz (period: 1 min.) frequency, 1.5 mm 0.059 in amplitude in X,Y and Z directions for two hours each				
Shock resistance	500 m/s ² acceleration (50 G approx.) in X,Y and Z directions for three times each				
Material		Enclosure: PBT, Front cover: Acrylic, Cable: PVC			
Cable		14-core cable with connector, 0.5 m 1.640 ft long			
Cable extension		Extension up to total 20 m 65.617 ft is possible with optional cable.			
Weight		Net weight: 70 g approx. (not including cable), 110 g approx. (including cable), Gross weight: 160 g approx.			
Accessory		Warning label: 1 set			

- Notes: 1) Where measurement conditions have not been specified precisely, the conditions used were as follows: supply voltage 24 V DC, ambient temperature +20 °C **+68 °F**, sampling rate 500 μs, average number of samples: 1024, measurement center distance, object measured is made of white ceramic and digital measurement values.
- 2) This beam diameter is the size at the measurement center distance. These values were defined by using 1/e² (13.5 %) of the center light intensity. If there is a slight leakage of light outside the normal spot diameter and if the periphery surrounding the sensing point has a higher reflectivity than the sensing point itself, then the results may be affected.
- 3) The fluctuation by ambient illuminance is ±0.1 % F.S. or less.

I/O CIRCUIT AND WIRING DIAGRAMS

I/O circuit diagrams

When selecting NPN output (positively grounded)

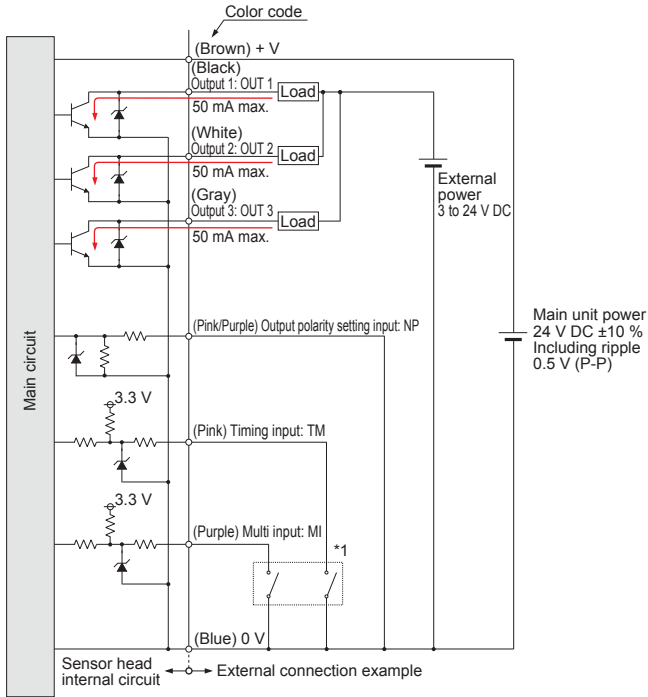

When selecting PNP output (negatively grounded)

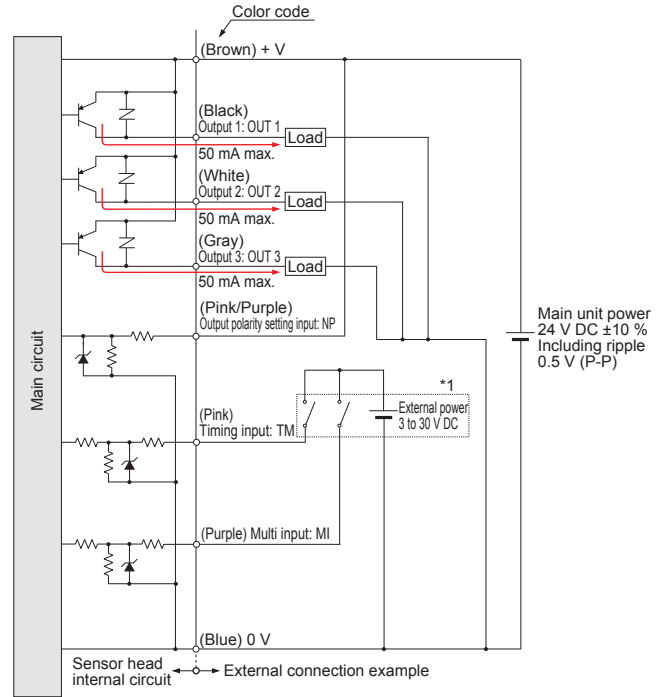

*1

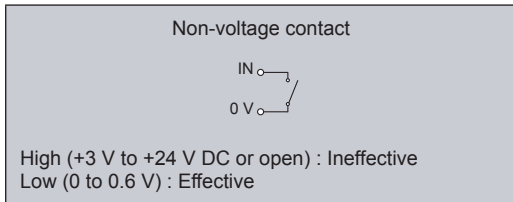

*1

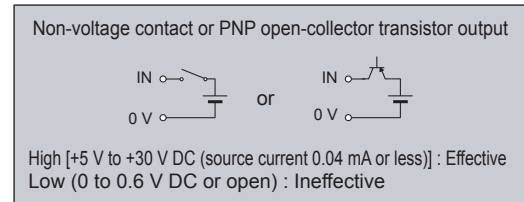

Analog output (common in NPN output type and PNP output type)

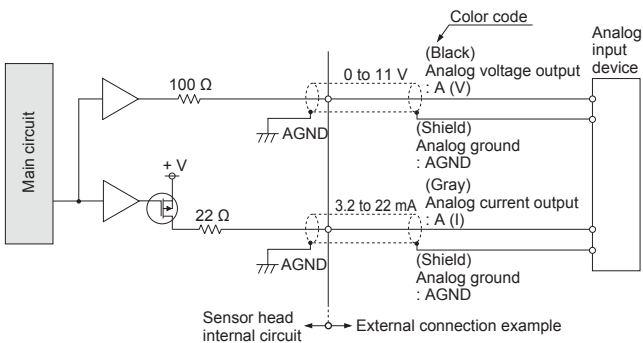

- Notes: 1) Analog output is not equipped with the short-circuit protection. Do not short-circuit or apply voltage to them.
2) Use shielded wires for analog outputs.

I/O CIRCUIT AND WIRING DIAGRAMS

Communication specifications (High functionality type)

Communication method	RS-422	RS-485
		Full duplex
Synchronization method	Asynchronous communication method	
Transmission code	ASCII	
Baud rate	9,600/19,200/38,400/115,200/230,400/460,800/921,600 bps	
Data length	8 bit	
Stop bit length	1 bit	
Parity check	None	
BCC	Yes	
Termination code	CR	

The **HL-G1** can be connected to upper devices of RS-422/485.

When upper device sends the request command, the **HL-G1** series send the response command.

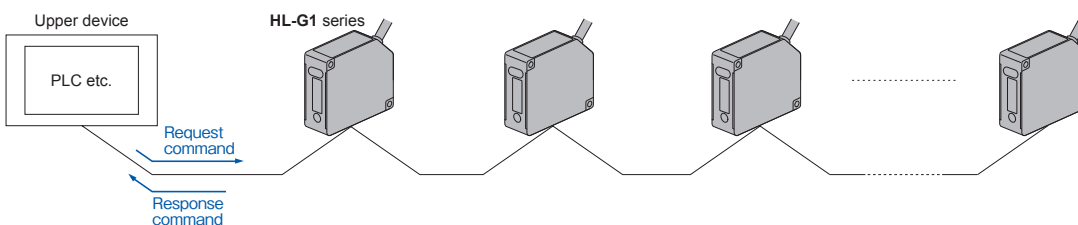

RS-422 connection (1:1)

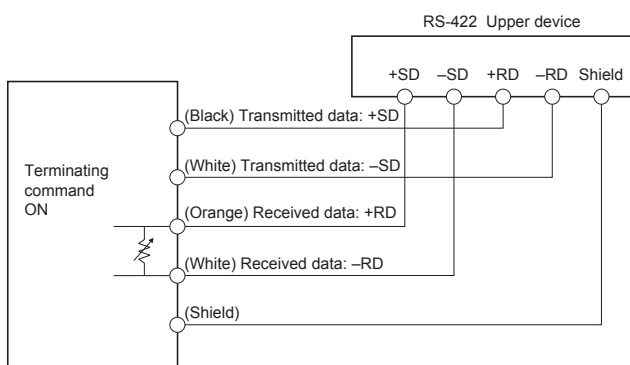

Note: Transmitted data cable or received data is twisted pair cable.

RS-485 connection (1:N)

- Connectable up to 16 units.
- Please set the code of sensor with no overlaps.

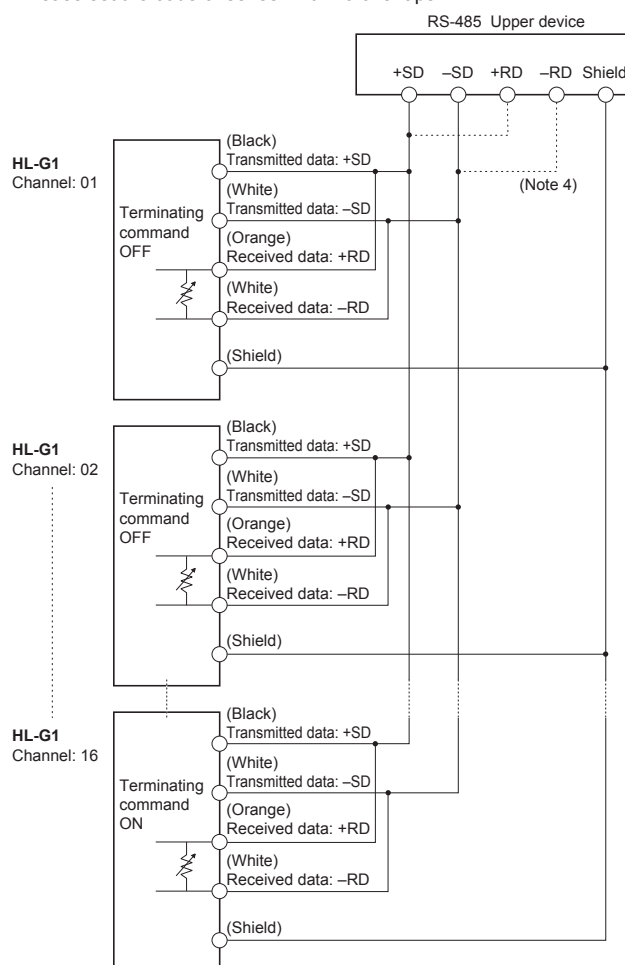

- Notes:
- 1) Transmitted data cable or received data is twisted pair cable.
 - 2) The terminating resistance is built in the sensor.
Make sure to set the terminating command of final sensor unit ON.
 - 3) The transmission line should be connected in series.
 - 4) Connect to the device in accordance with its specifications.

SENSING CHARACTERISTICS (TYPICAL)

Correlation between measuring distance and error characteristics

White ceramic (0°, ±10°)
Vertical orientation

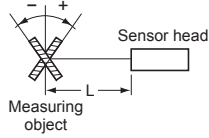

White ceramic (0°, ±10°)
Horizontal orientation

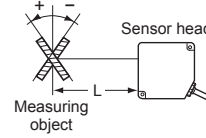

HL-G103

Vertical positioning

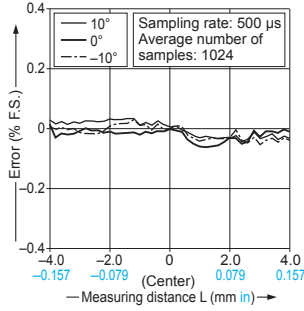

Horizontal positioning

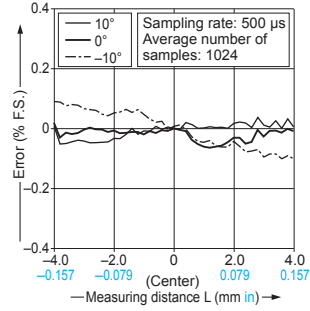

HL-G105

Vertical positioning

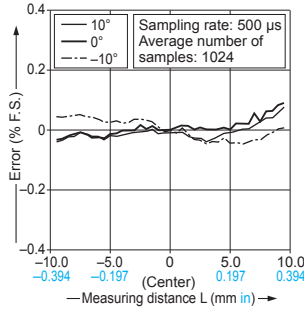

Horizontal positioning

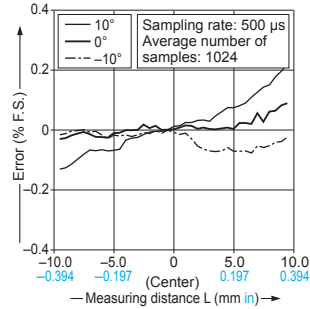

HL-G108

Vertical positioning

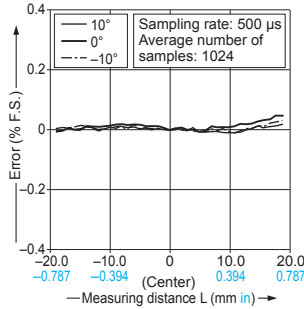

Horizontal positioning

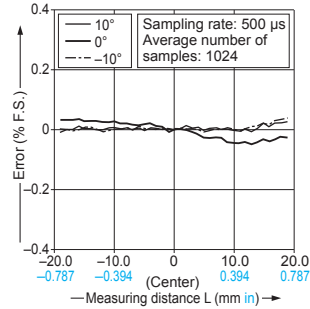

HL-G112

Vertical positioning

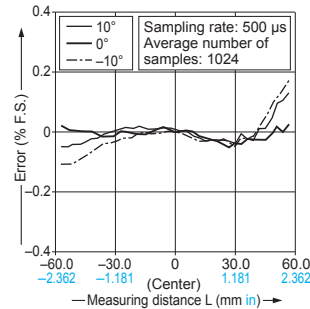

Horizontal positioning

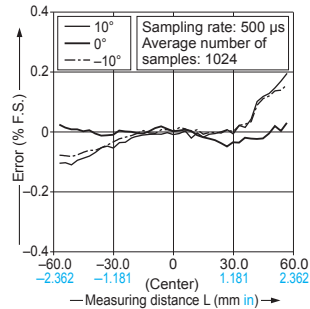

PRECAUTIONS FOR PROPER USE



- Never use this product as a sensing device for personnel protection.
- In case of using sensing devices for personnel protection, use products which meet laws and standards, such as OSHA, ANSI or IEC etc., for personnel protection applicable in each region or country.
- This product has been developed / produced for industrial use.



- Do not operate products using methods other than the ones described in the instruction manual included with each product. Control or adjustment through procedures other than the ones specified may cause hazardous laser radiation exposure.
- The following label is attached to the product. Handle the product according to the instruction given on the warning label.
(The Japanese, English, Chinese, Korean warning label is packed with the sensor.)

- This product is classified as a Class 2 Laser Product in IEC / JIS standards and a Class II Laser Product in FDA regulations. Do not look at the laser beam directly or through optical system such as a lens.

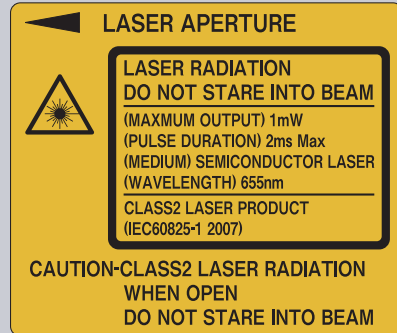

Beam diameter (Unit: mm in)

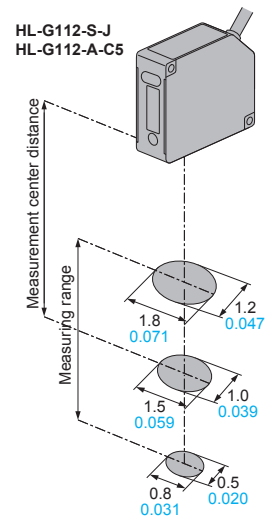
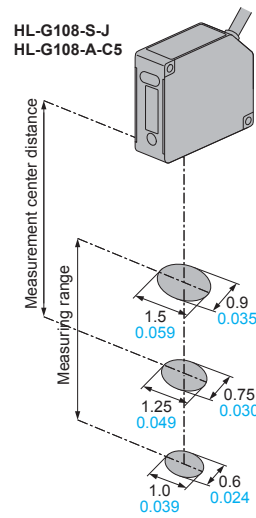
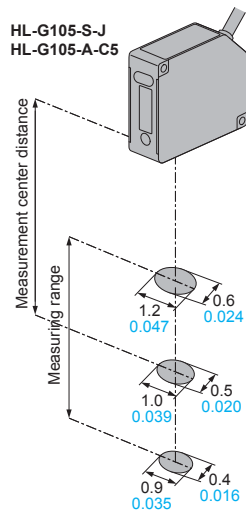
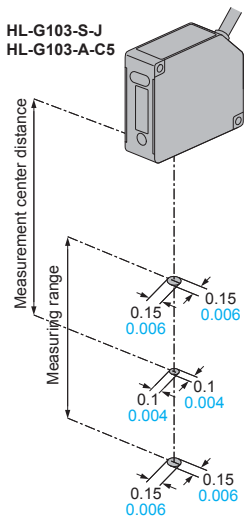

Sensor head mounting direction

- To obtain the greatest precision, the sensor head should be oriented facing the direction of movement of the object's surface, as shown in the figure below.

Object with variations in material or color

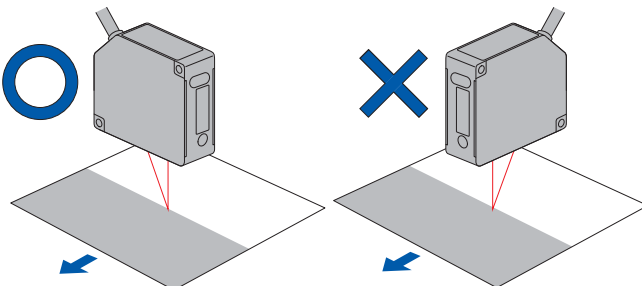

Rotating object

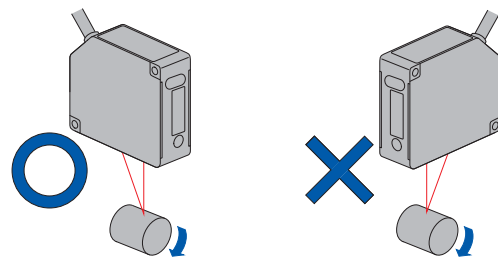

Object that has large differences in gaps, grooves and colors

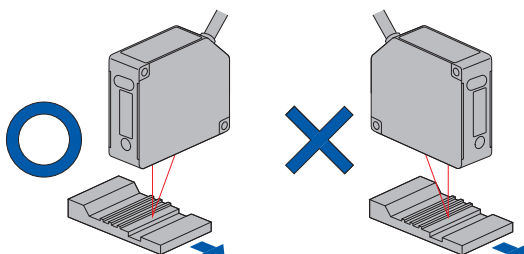

DIMENSIONS (Unit: mm in)

The CAD data in the dimensions can be downloaded from the website:
panasonic-electric-works.net/sunx

HL-G1□-A-C5

Sensor

Standard type

Model No.	Measurement center distance (ℓ)	θ
HL-G103-A-C5	30 mm 1.181 in	30°
HL-G105-A-C5	50 mm 1.969 in	21°
HL-G108-A-C5	85 mm 3.346 in	15°
HL-G112-A-C5	120 mm 4.724 in	11°

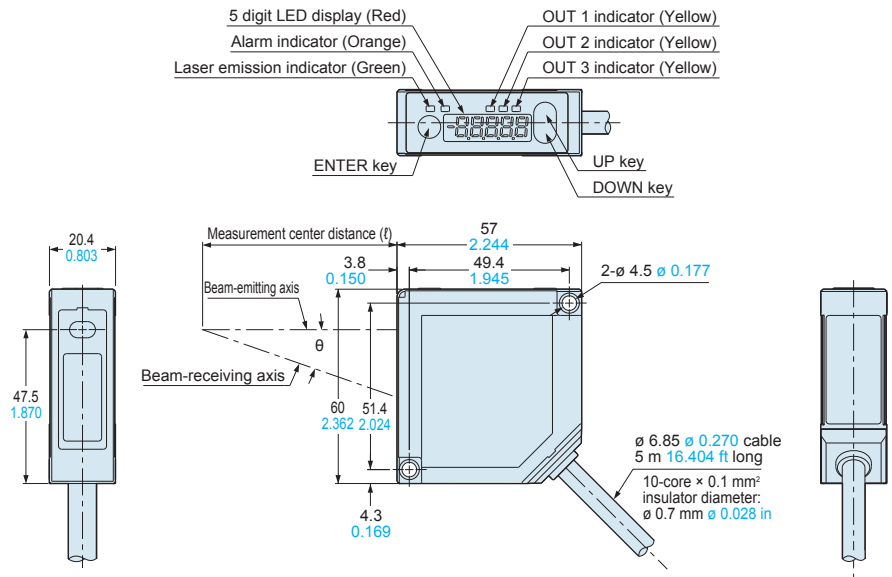

HL-G1□-S-J

Sensor

High functionality type

Model No.	Measurement center distance (ℓ)	θ
HL-G103-S-J	30 mm 1.181 in	30°
HL-G105-S-J	50 mm 1.969 in	21°
HL-G108-S-J	85 mm 3.346 in	15°
HL-G112-S-J	120 mm 4.724 in	11°

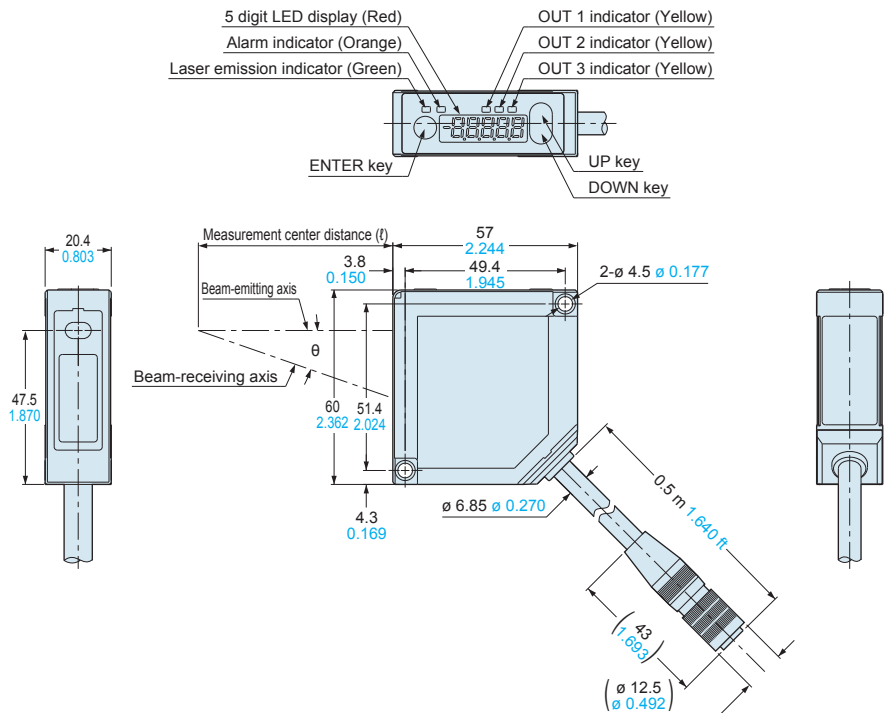

HL-G1CCJ□

Extension cable (Optional)

Model No.	L
HL-G1CCJ2	2000 ⁺²⁰⁰ ₀
HL-G1CCJ5	5000 ⁺⁵⁰⁰ ₀
HL-G1CCJ10	10000 ⁺¹⁰⁰⁰ ₀
HL-G1CCJ20	20000 ⁺²⁰⁰⁰ ₀

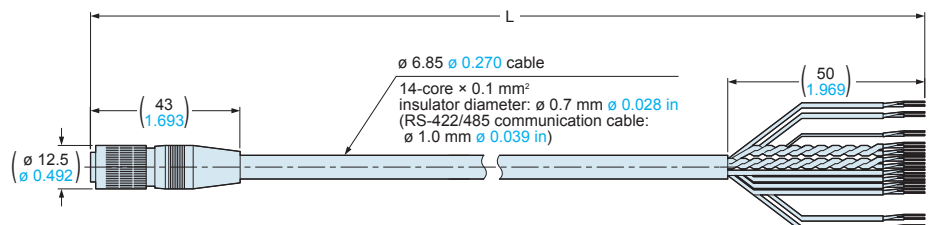

Please contact

Panasonic Electric Works SUNX Co., Ltd.

2431-1 Ushiyama-cho, Kasugai-shi, Aichi, 486-0901, Japan
■Telephone: +81-568-33-7211 ■Facsimile: +81-568-33-2631
Overseas Marketing Department
■Telephone: +81-568-33-7861 ■Facsimile: +81-568-33-8591
panasonic-electric-works.net/sunx

The Panasonic logo, consisting of the word "Panasonic" in a bold, blue, sans-serif font, with a registered trademark symbol (®) to the upper right of the "c".

All Rights Reserved ©Panasonic Electric Works SUNX Co., Ltd. 2010