

Buffered H-Bridge

FEATURES

- 1.0-A H-Bridge
- 500-kHz Switching Rate
- Shoot-Through Limited
- TTL Compatible Inputs
- 3.8- to 13.2-V Operating Range
- Surface Mount Packaging

APPLICATIONS

- VCM Driver
- Brushed Motor Driver
- Stepper Motor Driver
- Power Converter
- Optical Disk Drives
- Power Supplies
- High Performance Servo

DESCRIPTION

The Si9987 is an integrated, buffered H-bridge with TTL compatible inputs and the capability of delivering a continuous 1.0 A @ $V_{DD} = 5.0$ V (room temperature) at switching rates up to 500 kHz. Internal logic prevents the upper and lower outputs from being turned on simultaneously. Unique input codes allow both outputs to be forced low (for braking) or

forced to a high impedance level.

The Si9987 is available in an 8-Pin SOIC package, specified to operate over a voltage range of 3.8 V to 13.2 V, and the commercial temperature range of 0 to 70°C (C suffix) and -40 to 85°C (D suffix). The Si9987 is available in lead free.

FUNCTIONAL BLOCK DIAGRAM, PIN CONFIGURATION AND TRUTH TABLE

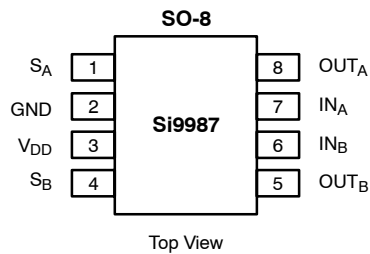

TRUTH TABLE			
IN _A	IN _B	OUT _A	OUT _B
1	0	1	0
0	1	0	1
0	0	0	0
1	1	HiZ	HiZ

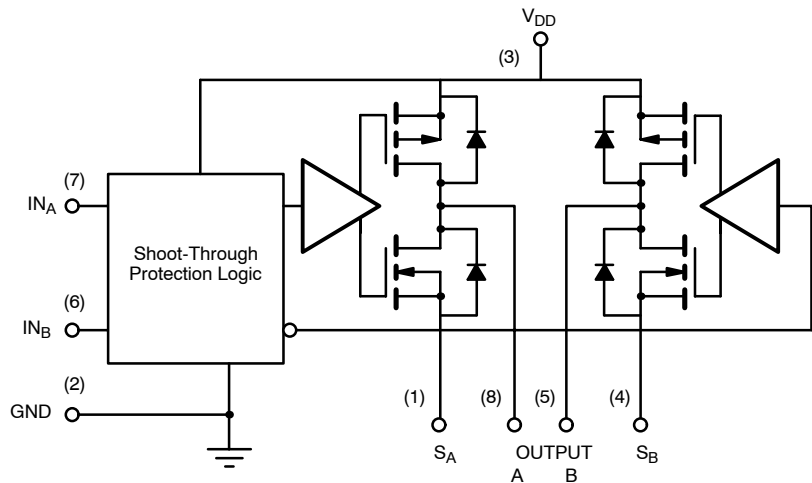

ORDERING INFORMATION		
Part Number	Temperature Range	Package
Si9987CY-T1	0 to 70°C	Tape and Reel
Si9987DY-T1	-40 to 85°C	
Si9987CY-T1—E3	0 to 70°C	Lead Free Tape and Reel
Si9987DY-T1—E3	-40 to 85°C	
Si9987CY	0 to 70°C	Bulk (tubes)
Si9987DY	-40 to 85°C	



ABSOLUTE MAXIMUM RATINGS^a

Voltage on any pin with respect to ground	-0.3 V to $V_{DD} + 0.3$ V
Voltage on pins 5, 8 with respect to GND	-1 V to $V_{DD} + 1$ V
Voltage on pins 1, 4	-0.3 V to GND +1 V
Maximum V_{DD}	15 V
Peak Output Current	1.5 A
Storage Temperature	-65 to 150°C
Maximum Junction Temperature (T_J)	150°C
Power Dissipation ^b	1 W
θ_{JA}	100°C/W

Continuous I_{OUT} Current ($T_J = 135^\circ\text{C}$) ^c	
$T_A = 25^\circ\text{C}$	± 1.02 A
$T_A = 70^\circ\text{C}$	± 0.75 A
$T_A = 85^\circ\text{C}$	± 0.65 A
Operating Temperature Range	
Si9987CY	0 to 70°C
Si9987DY	-40 to 85°C

Notes

- Device mounted with all leads soldered or welded to PC board.
- Derate 10 mW/°C above 25°C.
- $T_J = T_A + (P_D \times \theta_{JA})$, P_D = Power Dissipation.

RECOMMENDED OPERATING RANGE

V_{DD}	3.8 V to 13.2 V
Maximum Junction Temperature (T_J)	135°C

SPECIFICATIONS						
Parameter	Symbol	Test Conditions Unless Specified $V_{DD} = 3.8$ to 13.2 V S_A @ GND, S_B @ GND	Limits			Unit
			Min ^a	Typ ^b	Max ^a	
Input						
Input Voltage High	V_{INH}		2			V
Input Voltage Low	V_{INL}				1	
Input Current with Input Voltage High	I_{INH}	$V_{IN} = 2$ V			1	μA
Input Current with Input Voltage Low	I_{INL}	$V_{IN} = 0$ V	-1			
Output						
Output Voltage High ^c	V_{OUTH}	$I_{OUT} = -1$ A	$V_{DD} = 10.8$ V	10.40	10.56	V
			$V_{DD} = 4.5$ V	4.00	4.20	
		$I_{OUT} = -500$ mA	$V_{DD} = 10.8$ V	10.60	10.68	
$V_{DD} = 4.5$ V	4.25		4.35			
		$I_{OUT} = -300$ mA, $V_{DD} = 3.8$ V	3.63	3.70		
Output Voltage Low ^c	V_{OUTL}	$I_{OUT} = 1$ A	$V_{DD} = 10.8$ V		0.24	
			$V_{DD} = 4.5$ V		0.30	0.50
		$I_{OUT} = 500$ mA	$V_{DD} = 10.8$ V		0.12	0.20
			$V_{DD} = 4.5$ V		0.15	0.25
		$I_{OUT} = 300$ mA, $V_{DD} = 3.8$ V		0.10	0.17	
Output Leakage Current Low	I_{OLL}	$I_{NA} = I_{NB} \geq 2$ V, $V_{OUT} = V_{DD} = 13.2$ V		0	10	μA
Output Leakage Current High	I_{OLH}	$V_{OUT} = 0$, $V_{DD} = 13.2$ V	-10	0		
Output V Clamp High	V_{CLH}	$I_{NA} = I_{NB} \geq 2$ V	$I_{OUT} = 100$ mA	$V_{DD} + 0.7$	$V_{DD} + 0.9$	V
Output V Clamp Low	V_{CLL}		$I_{OUT} = -100$ mA	-0.9	-0.7	
Supply						
V_{DD} Supply Current	I_{DD}	$I_N = 100$ kHz, $V_{DD} = 5.5$ V		1.8	2.5	mA
		$I_{NA} = I_{NB} = 4.5$ V, $V_{DD} = 5.5$ V		75	125	μA
Dynamic						
Propogation Delay Time	T_{PLH}	$V_{DD} = 5$ V		300		nS
	T_{PHL}			100		

Notes

- The algebraic convention whereby the most negative value is a minimum and the most positive a maximum, is used in this data sheet.
- Typical values are for DESIGN AID ONLY, not guaranteed nor subject to production testing.
- Maximum value measured at $T_J = 135^\circ\text{C}$. Typical value measured at $T_J = T_A = 25^\circ\text{C}$ (pulse width ≤ 300 μsec , duty cycle $\leq 2\%$).

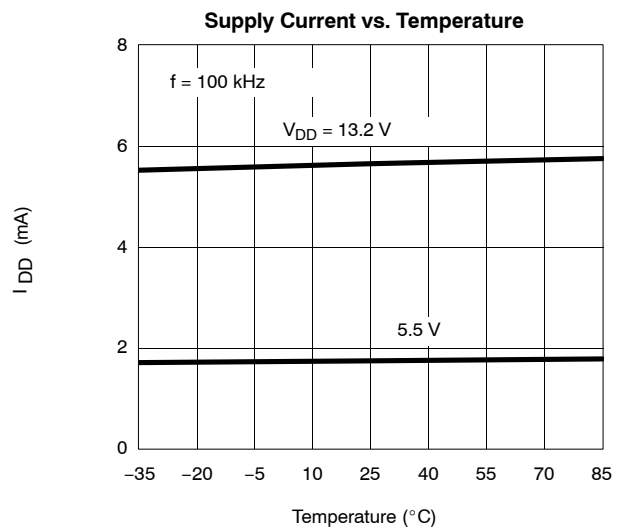
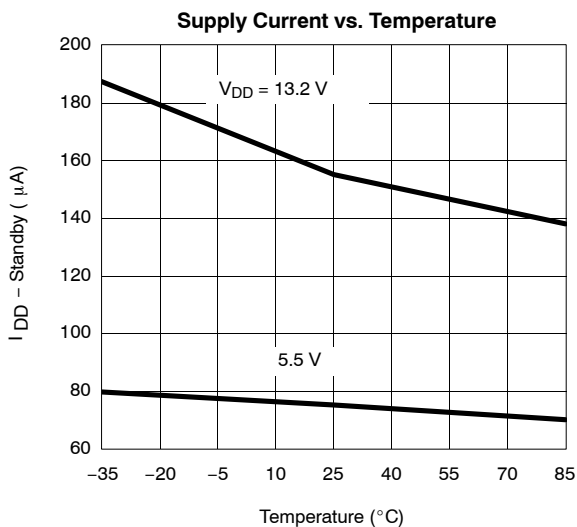
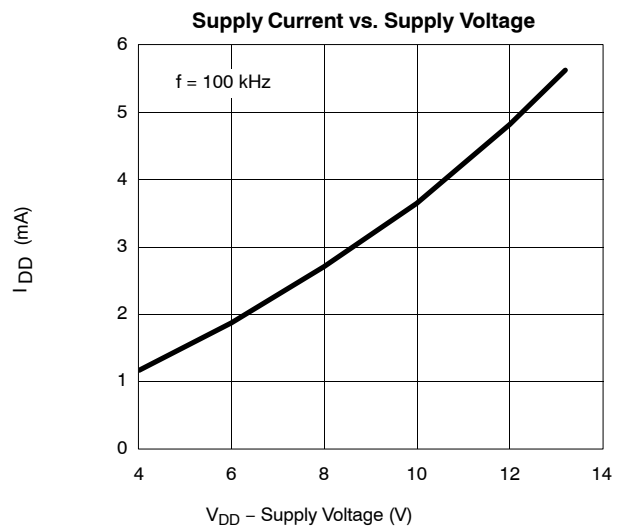
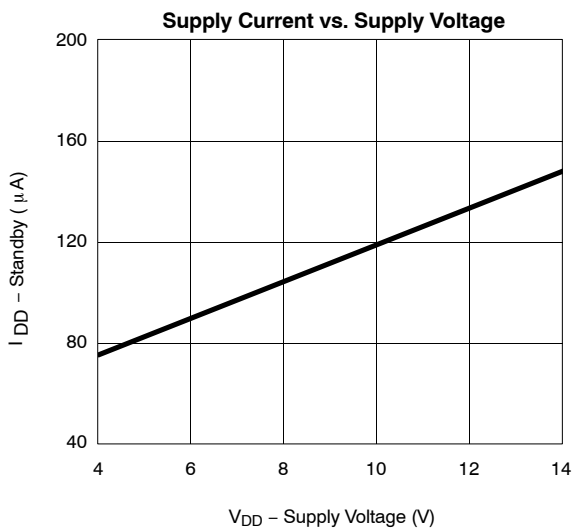
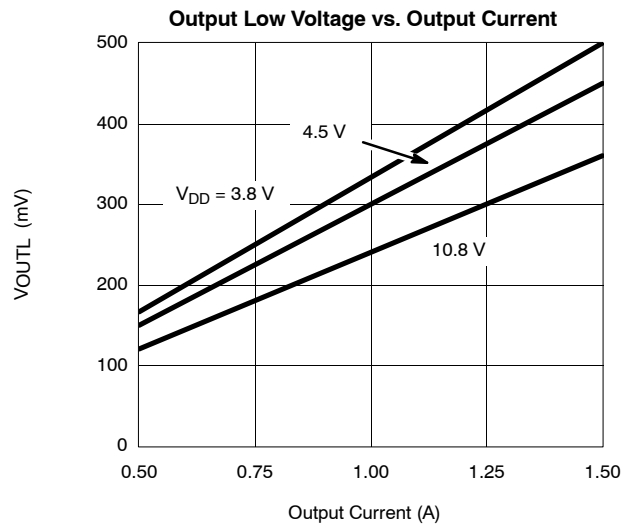
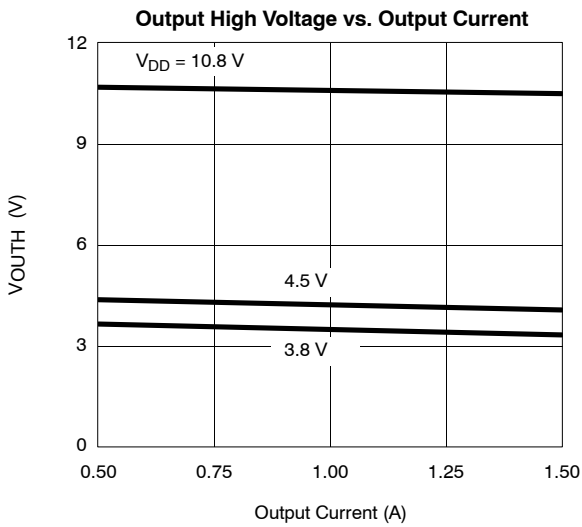
TYPICAL CHARACTERISTICS (25°C UNLESS NOTED)



TYPICAL CHARACTERISTICS (25 °C UNLESS NOTED)

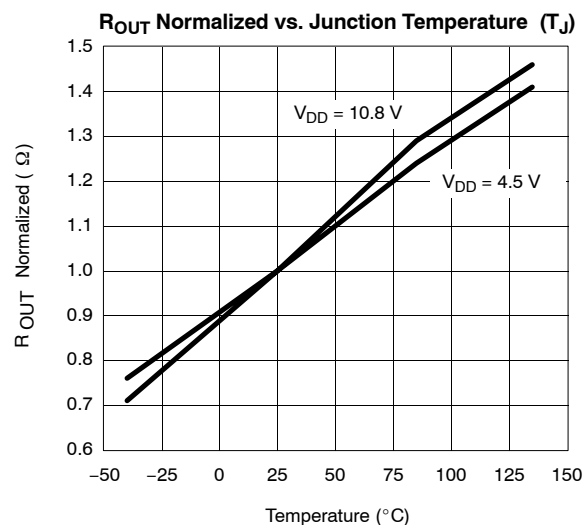
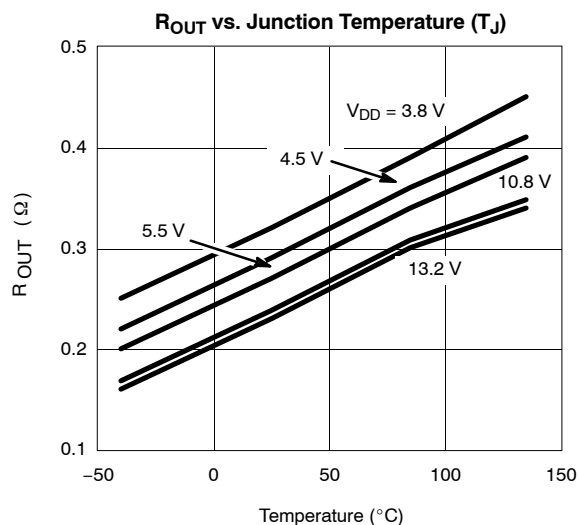
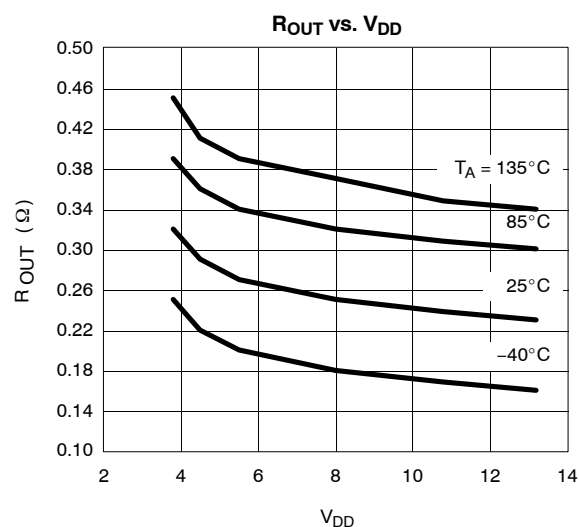
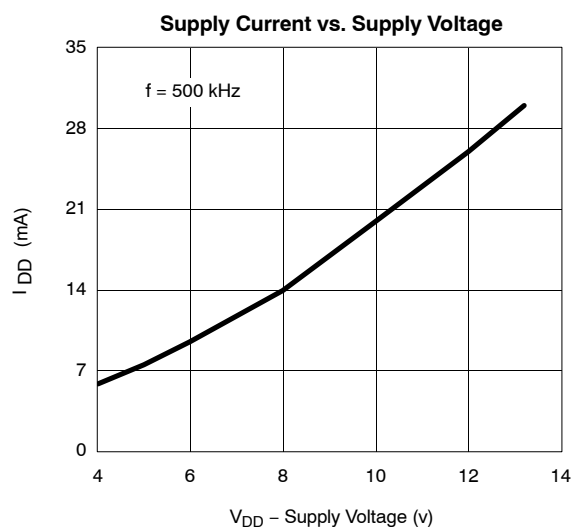
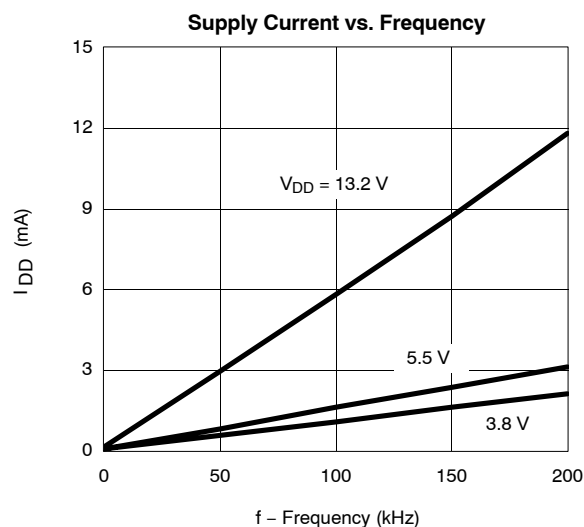
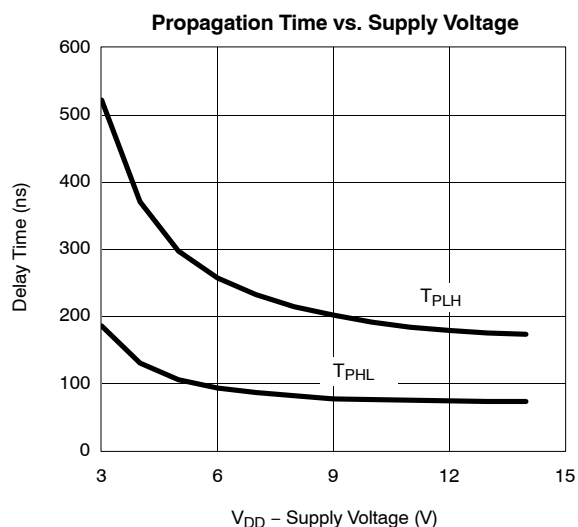



Notice

Specifications of the products displayed herein are subject to change without notice. Vishay Intertechnology, Inc., or anyone on its behalf, assumes no responsibility or liability for any errors or inaccuracies.

Information contained herein is intended to provide a product description only. No license, express or implied, by estoppel or otherwise, to any intellectual property rights is granted by this document. Except as provided in Vishay's terms and conditions of sale for such products, Vishay assumes no liability whatsoever, and disclaims any express or implied warranty, relating to sale and/or use of Vishay products including liability or warranties relating to fitness for a particular purpose, merchantability, or infringement of any patent, copyright, or other intellectual property right.

The products shown herein are not designed for use in medical, life-saving, or life-sustaining applications. Customers using or selling these products for use in such applications do so at their own risk and agree to fully indemnify Vishay for any damages resulting from such improper use or sale.

SOIC (NARROW): 8-LEAD

JEDEC Part Number: MS-012

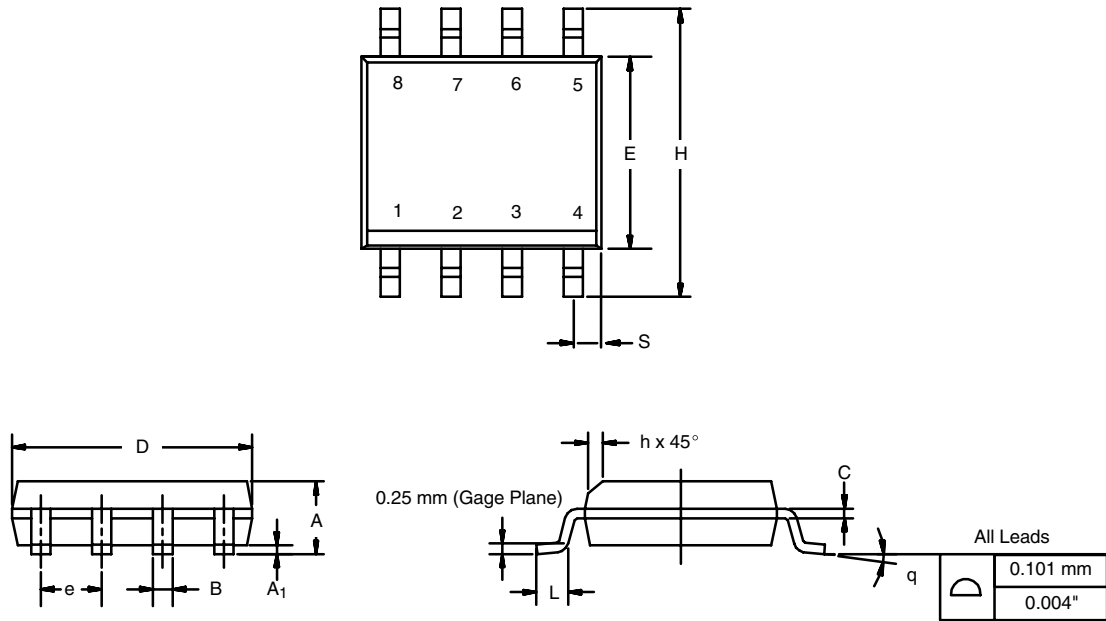

DIM	MILLIMETERS		INCHES	
	Min	Max	Min	Max
A	1.35	1.75	0.053	0.069
A ₁	0.10	0.20	0.004	0.008
B	0.35	0.51	0.014	0.020
C	0.19	0.25	0.0075	0.010
D	4.80	5.00	0.189	0.196
E	3.80	4.00	0.150	0.157
e	1.27 BSC		0.050 BSC	
H	5.80	6.20	0.228	0.244
h	0.25	0.50	0.010	0.020
L	0.50	0.93	0.020	0.037
q	0°	8°	0°	8°
S	0.44	0.64	0.018	0.026
ECN: C-06527-Rev. I, 11-Sep-06				
DWG: 5498				



Disclaimer

ALL PRODUCT, PRODUCT SPECIFICATIONS AND DATA ARE SUBJECT TO CHANGE WITHOUT NOTICE TO IMPROVE RELIABILITY, FUNCTION OR DESIGN OR OTHERWISE.

Vishay Intertechnology, Inc., its affiliates, agents, and employees, and all persons acting on its or their behalf (collectively, "Vishay"), disclaim any and all liability for any errors, inaccuracies or incompleteness contained in any datasheet or in any other disclosure relating to any product.

Vishay makes no warranty, representation or guarantee regarding the suitability of the products for any particular purpose or the continuing production of any product. To the maximum extent permitted by applicable law, Vishay disclaims (i) any and all liability arising out of the application or use of any product, (ii) any and all liability, including without limitation special, consequential or incidental damages, and (iii) any and all implied warranties, including warranties of fitness for particular purpose, non-infringement and merchantability.

Statements regarding the suitability of products for certain types of applications are based on Vishay's knowledge of typical requirements that are often placed on Vishay products in generic applications. Such statements are not binding statements about the suitability of products for a particular application. It is the customer's responsibility to validate that a particular product with the properties described in the product specification is suitable for use in a particular application. Parameters provided in datasheets and/or specifications may vary in different applications and performance may vary over time. All operating parameters, including typical parameters, must be validated for each customer application by the customer's technical experts. Product specifications do not expand or otherwise modify Vishay's terms and conditions of purchase, including but not limited to the warranty expressed therein.

Except as expressly indicated in writing, Vishay products are not designed for use in medical, life-saving, or life-sustaining applications or for any other application in which the failure of the Vishay product could result in personal injury or death. Customers using or selling Vishay products not expressly indicated for use in such applications do so at their own risk. Please contact authorized Vishay personnel to obtain written terms and conditions regarding products designed for such applications.

No license, express or implied, by estoppel or otherwise, to any intellectual property rights is granted by this document or by any conduct of Vishay. Product names and markings noted herein may be trademarks of their respective owners.

Material Category Policy

Vishay Intertechnology, Inc. hereby certifies that all its products that are identified as RoHS-Compliant fulfill the definitions and restrictions defined under Directive 2011/65/EU of The European Parliament and of the Council of June 8, 2011 on the restriction of the use of certain hazardous substances in electrical and electronic equipment (EEE) - recast, unless otherwise specified as non-compliant.

Please note that some Vishay documentation may still make reference to RoHS Directive 2002/95/EC. We confirm that all the products identified as being compliant to Directive 2002/95/EC conform to Directive 2011/65/EU.

Vishay Intertechnology, Inc. hereby certifies that all its products that are identified as Halogen-Free follow Halogen-Free requirements as per JEDEC JS709A standards. Please note that some Vishay documentation may still make reference to the IEC 61249-2-21 definition. We confirm that all the products identified as being compliant to IEC 61249-2-21 conform to JEDEC JS709A standards.