

Round Hole Illuminated Rocker, Square Bezel



Features

- Circuit Contains Illuminated Neon Indicator
- Single Pole



S93

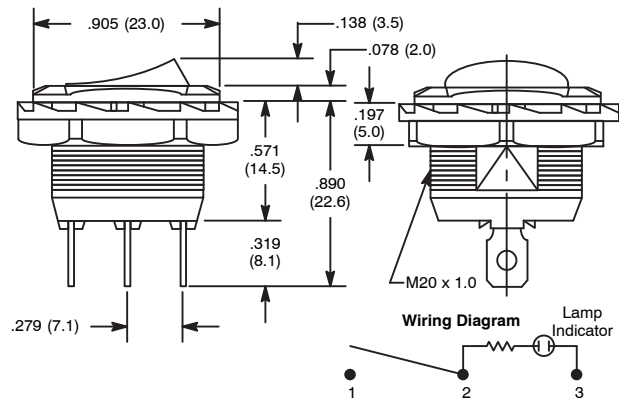

Specifications

Current Rating: 16A 125VAC, 10A 250VAC
Lamp Voltage: 110V Neon
Insulation Resistance: 100 Megohms (min.) at 500VDC
Dielectric Strength: 1500V RMS (min.)
Temperature Rating: -4° to +149°F (-20° to +65°C)
Electrical Life: 6000 cycles (min.)
Mechanical Life: 100,000 cycles (min.)
Terminal Type: .187" Tab Q.C.
Mounting Hole: .795 (20.2)

NTE Type No.	Circuitry	Action			Actuator		Diag No.
					Material	Color	
54-513	SPST	ON	NONE	OFF	Nylon	Red	S93
54-549	SPST	ON	NONE	OFF	Nylon	Amber	S93
54-550	SPST	ON	NONE	OFF	Nylon	Green	S93

Round Hole Illuminated Rocker, Square Bezel



Features

- Independent, Illuminated LED Indicator
- Single Pole



S118

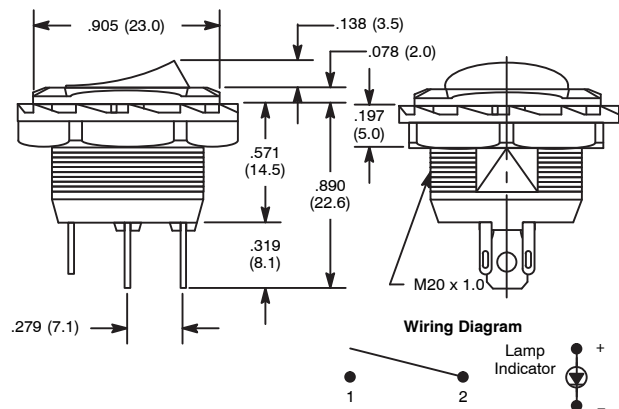

Specifications

Current Rating: 16A 125VAC, 10A 250VAC
Lamp Voltage: 3V LED
Insulation Resistance: 100 Megohms (min.) at 500VDC
Dielectric Strength: 1500V RMS (min.)
Temperature Rating: -4° to +149°F (-20° to +65°C)
Electrical Life: 6000 cycles (min.)
Mechanical Life: 100,000 cycles (min.)
Terminal Type: .187" Tab Q.C.
Mounting Hole: .795 (20.2)

NTE Type No.	Circuitry	Action			Actuator		Diag No.
					Material	LED Color	
54-551	SPST	ON	NONE	OFF	Nylon	Red	S118
54-552	SPST	ON	NONE	OFF	Nylon	Amber	S118
54-553	SPST	ON	NONE	OFF	Nylon	Green	S118
54-554	SPST	ON	NONE	OFF	Nylon	Blue	S118

NOTE: LED is independently lit.