

E47 Precision Switch



Compact Prewired Switch



LS-Titan Miniature DIN Switch



E49 Compact Metal Switch



Heavy-Duty Factory Sealed 6P+ Switch



| | |
|---|-----------------|
| 2.0 Introduction | |
| Technical Reference | V8-T2-2 |
| Product Selection Guide | V8-T2-3 |
| 2.1 E47 Precision Switches | |
| Product Description | V8-T2-6 |
| Product Selection | V8-T2-7 |
| 2.2 Compact Prewired Switches | |
| Product Description | V8-T2-15 |
| Product Selection | V8-T2-16 |
| 2.3 LS-Titan Miniature DIN Switches | |
| Product Description | V8-T2-21 |
| Product Selection | V8-T2-23 |
| 2.4 E49 Mini Metal Switches | |
| Product Description | V8-T2-43 |
| Product Selection | V8-T2-44 |
| 2.5 E49 Compact Metal Switches | |
| Product Description | V8-T2-49 |
| Product Selection | V8-T2-50 |
| 2.6 E50 Heavy-Duty Plug-In Switches | |
| Product Description | V8-T2-54 |
| Product Selection | V8-T2-55 |
| 2.7 E50 Heavy-Duty Factory Sealed 6P+ Switches | |
| Product Description | V8-T2-68 |
| Product Selection | V8-T2-69 |
| 2.8 Operators | |
| Product Description | V8-T2-80 |
| Product Selection | V8-T2-81 |
| 2.9 Non Plug-In Switches | |
| Product Description | V8-T2-89 |
| Product Selection | V8-T2-90 |
| 2.10 Hazardous Location Limit Switches | |
| Product Description | V8-T2-92 |
| Product Selection | V8-T2-93 |
| 2.11 Special Purpose Limit Switches | |
| Product Description | V8-T2-96 |
| Product Selection | V8-T2-97 |



Unless otherwise noted, the products contained in this section should not be used for functional safety applications. These products were not designed or tested to IEC 60947-5-3 or recommended for functional safety.



For Customer Service in the U.S. call 1-877-ETN CARE (386-2273),
in Canada call 1-800-268-3578.
For Application Assistance in the U.S. and Canada
call 1-800-426-9184.

Technical Reference

Limit Switches

2



Mechanical Limit Switches are contact sensors widely used for detecting the presence or position of objects in industrial applications.

Limit Switches offer high precision in terms of accuracy and repeatability. This is primarily due to the fact that they make direct contact with the target. When an object contacts the limit switch lever (or plunger) the lever moves a pre-travel distance to the operating point where the contacts are tripped. Movement of the lever beyond this point is called the over-travel.

Limit switches contain the following major components. These may be modular or part of a single-piece switch.

Limit Switch Components

Lever Type Actuator

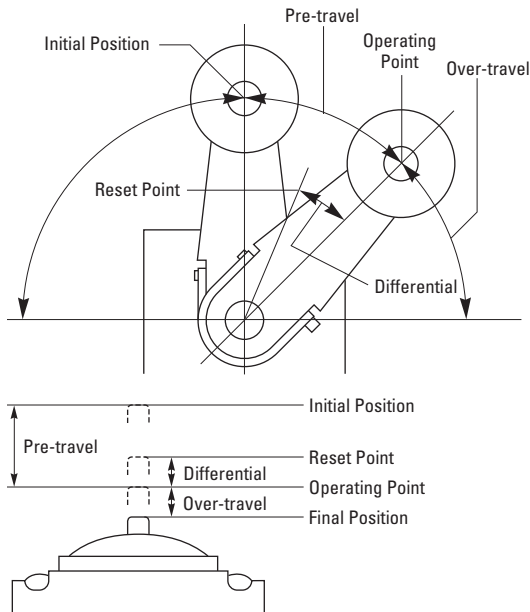

Refer to Sensor Learning Course, **Page V8-T12-4**, for a complete description of limit switch terminology.

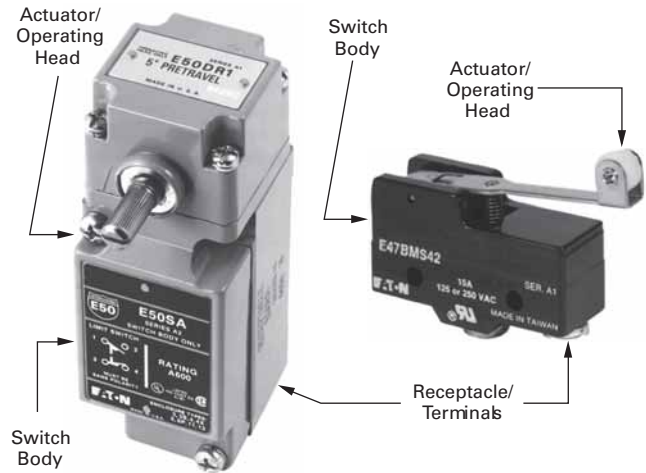

Actuator

This is the part of the switch that contacts the target. Typical actuators are levers and plungers. Several styles are available, see Sensor Learning Course, **Page V8-T12-4**, for more information.

Switch Body

This part contains the electrical contact mechanism. For complete information on electrical outputs, see Sensor Learning Course, **Page V8-T12-4**.

Terminals

The terminals are the point of connection for the wiring. These terminals may be on the body itself, or housed in a removable receptacle. The limit switch may also come equipped with a factory installed cable or pin-connector.

Product Selection Guide

E47 Precision Switches



Page V8-T2-6

Overview

Specified when accurate repeatability, choice of operating forces and travel characteristics and tightly controlled action of cam or target in space restricted areas are of prime importance. Cost effective and compact.

Applications

Overhead, folding and elevator doors, sliding gates, automated guided vehicles and commercial instrumentation

Product Features

Self-contained switches or with an enclosed cast housing for increased durability and conduit connection (1/2 in NPT)

High current capacity for power load switching and motor handling capability

Screw and solder terminations

Booted enclosed version shields actuators from debris

Mounting centers—1.0 in (25.4 mm), #8 screw size

Technical Data and Specifications

Mechanical life: 3,000,000 operations min.

Electrical life: 500,000 operations min.

Contact ratings—
NEMA A600, R300, AC-15, DC-13
15A/20A, 125 or 250 Vac

Enclosure ratings—
Enclosed: NEMA 1

Construction—
Basic: Phenolic

Enclosed: Aluminum die cast

Approvals

UL® Recognized
CSA® Certified
CE



Compact Prewired Switches



Page V8-T2-15

Overview

Designed to be a versatile, slim device for hard to fit applications where sealing integrity is required.

Applications

Machine tool, food processing and packaging

Product Features

Rugged aluminum alloy die cast housing
Sealed construction with enclosure ratings of NEMA 4, 6 and 13

Prewired with 3m of 18 AWG, AWM 2517, 300V cable

Stackable ridge for ganged operation

Technical Data and Specifications

Mechanical life: 10,000,000 operations min.

Electrical life: 200,000 operations
30 operations min.

Contact ratings—
NEMA B300

Enclosure ratings—
NEMA 4, 6 and 13; IP67, IP69K

Construction—
Aluminum alloy die cast

Approvals

cULus



LS-Titan Miniature DIN Switches



Page V8-T2-21

Overview

Safety position switches with insulated plastic or rugged metal enclosures. Approved for worldwide safety application.

Applications

Automatic vending machines, electronic assembly machines, elevators and lifts, injection molding, packaging and safety applications

Product Features

Modular plug-in head and body components

Positive opening NC contacts for safety applications

Operating heads can be rotated 90 degrees to suit specific direction of operation

Technical Data and Specifications

Mechanical life: 8,000,000 operations

Contact ratings—
AC-15, 6A at 24V, 6A at 230/240V,
4A at 400/415V;
DC-13, 3A at 24V, 800 mA at 110V,
300 mA at 220V

Enclosure ratings—
IP66, IP67 (by model)

Construction—
Plastic or metal (by model)

Approvals

Safety function, IEC/EN 60947-5-1
TUV-Rheinland certified (LSE models)
CSA certified
UL listed
CE
CCC



E49 Mini Metal Switches



Page V8-T2-43

Overview

Suitable for OEMs who require a small, cost-effective solution but cannot sacrifice durability and mechanical life as they would if they chose a plastic IEC style switch.

Applications

Automatic vending machines, electronic assembly machines, elevators and lifts, injection molding, packaging

Product Features

Pre-wired units with custom cable lengths available for high volume customers

“Fingerproof” terminals protect against accidental shock

Double-spring mechanism for contact reliability

Grounding terminal included

Captive screws on enclosure cover make wiring hassle-free

SPDT double break

Technical Data and Specifications

Contact ratings—
5A at 250 Vac
5A at 30 Vdc

Enclosure ratings—
IP65

Construction—
Zinc alloy

Approvals

UL Recognized
CE



E49 Compact Metal Switches



Page V8-T2-49

Overview

Designed with high mechanical strength for robust environments. The rugged Aluminum die cast construction provides reliable, oil-tight, waterproof and dustproof sealing for a variety of applications. Snap action 1NO-1NC contacts provide flexibility in design.

Applications

Packaging, material handling conveyors, end-of-travel and guarding operations, baler/compactor, industrial door lifts

Product Features

Rigid die cast switch housing
Set position indicator plate for easy maintenance
High mechanical strength
Oiltight, waterproof and dustproof construction

Technical Data and Specifications

Mechanical life: 15,000,000 operations min.
Electrical life: 500,000 operations min. at full load
Contact ratings—
NEMA A600, R300; AC-15, DC-13
Enclosure ratings—
NEMA 4, 4X, 6, 6P, 12, 13; IP65, IP67
Construction—
Aluminum die cast

Approvals

cULus
IP67



E50 Heavy-Duty Plug-In Switches



Page V8-T2-54

Overview

Versatile in design. High reliability. Low maintenance costs with installation ease. BEST CHOICE for Heavy-Duty Limit Switch applications. Withstands physical and chemical abuse of harsh industrial environments.

Applications

Punch presses, waste water treatment, machine tool, automotive, retrieval systems, industrial truck, car wash lines

Product Features

Modular operating heads, switch bodies and receptacles are interchangeable without field adjustment
Order as complete assemblies or components for stocking and manufacturing flexibility
90 degree total travel, 5 degree pre-travel characteristics are standard features
Viton® gasket, boot, and seal material offers exceptional chemical resistance
Rotary head operating mode from CW, CCW or CW and CCW is easily changed without tools

Technical Data and Specifications

Mechanical life: 13,000,000 operations min.
Electrical life: 1,000,000 operations min. at full load (single-pole)
Contact ratings—
NEMA A600, R300
Lighted versions A150, R150
6A, 120 Vac; 10A continuous
Enclosure ratings—
NEMA 1, 3, 3S, 4, 4X, 6, 6P, 13; IP67
Construction—Zinc die cast

Approvals

UL Listed
CSA Certified
IEC 947-5-1
TUV
CE (some models)



E50 Heavy-Duty Factory Sealed 6P+ Switches



Page V8-T2-68

Overview

Designed specifically to withstand the penetrating properties of new cutting fluids (coolants), acid or caustic washes, salt spray, severe vibration, shock and temperature fluctuations, grit and debris.

Applications

Automotive, pulp and paper, food processing, waste management, primary metals, machine tool (cutting, forming, bending)

Product Features

Tamperproof, one-piece switch body assembly, epoxy filled
Factory sealed. 6P submersible. Pre-wired with cable, pigtail or pin connector options. All with ground connection
Utilizes E50 modular operating heads
Special V-seal on switch body/head connection provides hermetic barrier against fluid ingress
LED indicating light, 24V–120 Vac/dc neon version too
Peel off see-through painting mask over nameplate

Technical Data and Specifications

Mechanical life: 35,000,000 operations min.
Electrical life: 1,000,000 operations min. at full load
Contact ratings—
NEMA A600, R300
Lighted versions A150, R150
6A, 120 Vac; 10A continuous
Enclosure ratings—
NEMA 1, 2, 3, 3S, 4, 4X, 6, 6P, 13; IP67, IP69K
Construction—Zinc die cast

Approvals

UL Listed
CSA Certified
IEC 947-5-1
TUV
CE (some models)



Operators



Page V8-T2-80

Overview

Wide variety of operator types for rotary and wobble style limit switches.

Applications

Used with E50, E50 6P+ and 10316 limit switches

Product Features

Rollers and rods available in metal and nonmetal contact surfaces

Technical Data and Specifications

Varies by model

Approvals

Varies by model

Non Plug-In Switches



Page V8-T2-89

Overview

The Industrial standard for Non Plug-In Heavy-Duty Limit Switches. Sold as complete assembled units only.

Applications

Serving MRO and USER replacement requirements with broad d market coverage

Product Features

Side and top rotary, side and top push or wobble operation
 CW, CCW or CW and CCW operating modes are field convertible
 Double break-make snap action contacts, same polarity each pole
 Captive saddle clamp terminals accept up to #12 wire
 Head can be mounted in any of four discrete positions, intervals of 90 degrees

Technical Data and Specifications

Mechanical life: 10,000,000 operations min.
 Electrical life: 500,000 operations at full load
 Contact ratings—NEMA A600, R300 6A, 120 Vac; 10A continuous
 Enclosure ratings—NEMA 1, 4, 13
 Construction—
 Zinc die cast

Approvals

UL Listed
 CSA Certified



Hazardous Location Switches



Page V8-T2-92

Overview

Designed for severe environmental service in locations where there exists a danger of an internal or external explosion of flammable gases, vapors, metal alloy or grain dust.

Applications

Mining, metal cutting, grain storage, forest products, petrochemical, waste and sewage management, pharmaceutical

Product Features

Sealed and unsealed versions available
 One-way gasket on sealed version keeps liquids out, yet allows a harmless release of gases in the event of an internal explosion
 Silicon bronze housing provides excellent corrosion resistant properties in extreme NEMA 4X applications
 Temperature build-up on limit switch surface is dissipated by housing design and materials used
 Utilizes the operating heads and internal switch mechanisms of the 10316 Non Plug-In line

Technical Data and Specifications

NEMA 7, Div. 1, Class I, BCD
 NEMA 9, Div. 1, Class II, EFG
 Contact ratings—NEMA B600 3A, 120 Vac; 5A continuous
 Enclosure ratings—LX: NEMA 7, 9
 CX: NEMA 1, 4, 7, 9
 CB: NEMA 1, 4, 4X, 13
 CBX: NEMA 1, 4, 4X, 7, 9, 13
 Construction—LX, CX: Aluminum die cast
 CB, CBX: Silicon bronze

Approvals

cUL® Listed



Special Purpose Switches



Page V8-T2-96

Overview

Variety of special function limit switch products.

Applications

Serving MRO and USER replacement requirements with broad market coverage

Product Features

Special function switch lines include:
 Cabinet door interlocks — when plunger is pulled out, red band indicator visually shows that interlock is defeated
 Precision switches—1NO-1NC, 2NO-2NC, or operator only. Variety of mounting brackets available
 Pneumatic time delay—ON delay and OFF delay. Timing range—0.05 to 60 seconds
 Rotating cam shaft switches

Technical Data and Specifications

See **Page V8-T2-99** for more information
 Enclosure ratings—
 NEMA 1 or NEMA 4 versions
 Construction—
 Zinc die cast
 PS: Phenolic

Approvals

UL Listed
 CSA Certified (PS and J only)



2.1

Limit Switches

E47 Precision Switches

E47 Precision Switches

2



E47 Precision Switches

Product Description

E47 Precision Switches from Eaton's electrical sector provide high accuracy switching at an affordable price. A variety of standard features, such as current capacity, operating force, travel characteristics and actuators, lets you custom fit the switch to your application.

The switches are available in their compact basic form, or enclosed in a rugged, metal housing.

Features

- Compact housings are ideal for use where space is restricted
- Precision, snap-action operators provide accurate repeatability of electrical and mechanical operating characteristics
- High current capacity (up to 20A) allows power load switching and motor handling capability
- Enclosed booted versions shield actuators from debris

Contents

Description

| | <i>Page</i> |
|---|-----------------|
| E47 Precision Switches | |
| Product Selection | |
| Basic Switches | V8-T2-7 |
| Enclosed Switches | V8-T2-9 |
| Accessories | V8-T2-10 |
| Technical Data and Specifications | V8-T2-10 |
| Dimensions | V8-T2-12 |



For the most current information on this product, visit our Web site: www.eaton.com

Operating Characteristics

Definitions

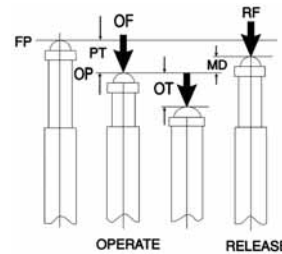

- OF—Operating Force
- RF—Return Force
- PT—Pre-Travel
- OT—Over-Travel
- MD—Movement Differential
- FP—Free Position
- OP—Operating Position

Standards and Certifications

- UL Recognized
- CSA Certified
- CE
- RoHS



⚠ DANGER

THIS SENSOR IS NOT A SAFETY DEVICE AND IS NOT INTENDED TO BE USED AS A SAFETY DEVICE. This sensor is designed only to detect and read certain data in an electronic manner and perform no use apart from that, specifically no safety-related use. This sensor product does not include self-checking redundant circuitry, and the failure of this sensor product could cause either an energized or de-energized output condition, which could result in death, serious bodily injury, or property damage.

For Customer Service in the U.S. call 1-877-ETN CARE (386-2273), in Canada call 1-800-268-3578. For Application Assistance in the U.S. and Canada call 1-800-426-9184.

Product Selection

Basic Switches

E47 Precision Switches—Basic

| Type | Specifications ^① | 15A Catalog Number | 20A Catalog Number |
|---|---|-----------------------|------------------------------|
| Pin Plunger | | | |
|  Pin Plunger | | | |
| Screw terminal | OF max.—12.3 oz (350g) RF max.—4.02 oz (114g) PT max.—0.016 in (0.4 mm) | E47BMS01 | E47CMS01 |
| Solder terminal | OT max.—0.005 in (0.13 mm) MD max.—0.002 in (0.05 mm) OP—0.626 in (15.9 mm) | E47BML01 | E47CML01 ^② |
| Extended Plunger | | | |
|  Extended Plunger | | | |
| Screw terminal | OF max.—12.3 oz (350g) RF max.—4.02 oz (114g) PT max.—0.016 in (0.4 mm) | E47BMS03 | — |
| Solder terminal | OT max.—0.063 in (1.6 mm) MD max.—0.002 in (0.05 mm) OP—1.11 in (28.2 mm) | E47BML03 | — |
| Straight Plunger | | | |
|  Straight Plunger | | | |
| Screw terminal | OF max.—12.3 oz (350g) RF max.—4.02 oz (114g) PT max.—0.016 in (0.4 mm) | E47BMS02 | E47CMS02 |
| Solder terminal | OT max.—0.063 in (1.6 mm) MD max.—0.002 in (0.05 mm) OP—0.846 in (21.5 mm) | E47BML02 | E47CML02 |
| Reversed Lever | | | |
|  Reversed Lever | | | |
| Screw terminal | OF max.—5.29 oz (150g) RF max.—0.49 oz (14g) PT max.—0.16 in (4 mm) | E47BMS21 | — |
| Solder terminal | OT max.—0.063 in (1.6 mm) MD max.—0.051 in (1.3 mm) FP max.—0.81 in (20.6 mm) | E47BML21 | — |
| Spade terminal | OP—0.685 in (17.4 mm) | E47BMT21 | — |
| Straight Lever | | | |
|  Straight Lever | | | |
| Screw terminal | OF max.—2.47 oz (70g) RF min.—0.49 oz (14g) PT max.—0.394 in (10 mm) OT max.—0.220 in (5.6 mm) | E47BMS22 | E47CMS22 |
| Solder terminal | MD max.—0.051 in (1.3 mm) FP max.—1.11 in (28.2 mm) OP—0.748 in (19 mm) | E47BML22 | — |
| Standard Lever | | | |
|  Standard Lever | | | |
| Screw terminal | OF max.—3.53 oz (100g) RF min.—0.99 oz (28g) PT max.—0.197 in (5.0 mm) OT max.—0.079 in (2.0 mm) | E47BMS20 | — |
| Solder terminal | MD max.—0.039 in (1.0 mm) FP max.—0.976 in (24.8 mm) OP—0.748 in (19 mm) | E47BML20 | — |
| Extended Straight Plunger | | | |
|  Extended Straight Plunger | | | |
| Screw terminal | OF max.—12.3 oz (350g) RF max.—4.02 oz (114g) PT max.—0.016 in (0.4 mm) | E47BMS04 | E47CMS04 |
| Screw terminal (with space lugs) | OT max.—0.217 in (5.5 mm) MD max.—0.002 in (0.05 mm) OP—0.858 in (21.8 mm) | E47BMT04 | — |
| Solder terminal | | E47BML04 | E47CML04 |

Notes

^① OF = Operating Force; RF = Return Force; PT = Pre-Travel; OT = Over-Travel; MD = Movement Differential; FP = Free Position; OP = Operating Position.

^② Contact Eaton's Sensor Applications Department at 1-800-426-9184 for approval status.



E47 Precision Switches—Basic, continued

| Type | Specifications ^① | 15A Catalog Number | 20A Catalog Number |
|---|---|-----------------------|-----------------------|
| Roller Plunger | | | |
|  Roller Plunger | | | |
| Screw terminal | OF max.—12.3 oz (350g) RF max.—4.02 oz (114g) PT max.—0.016 in (0.4 mm) OT max.—0.14 in (3.6 mm) MD max.—0.002 in (0.05 mm) | E47BMS10 | E47CMS10 |
| Solder terminal | OP—1.315 in (33.4 mm) | E47BML10 | — |
| Cross Roller Plunger | | | |
|  Cross Roller Plunger | | | |
| Screw terminal | OF max.—12.3 oz (350g) RF max.—4.02 oz (114g) PT max.—0.016 in (0.4 mm) OT max.—0.14 in (3.6 mm) MD max.—0.002 in (0.05 mm) | E47BMS11 | E47CMS11 |
| Solder terminal | OP—1.315 in (33.4 mm) | E47BML11 | — |
| Reversed Roller Lever | | | |
|  Reversed Roller Lever | | | |
| Screw terminal | OF max.—5.29 oz (150g) RF max.—0.49 oz (14g) PT max.—0.16 in (4 mm) OT max.—0.063 in (1.6 mm) | E47BMS41 | — |
| Solder terminal | MD max.—0.051 in (1.3 mm) FP max.—1.252 in (31.8 mm) OP—1.126 in (28.6 mm) | E47BML41 | — |
| Extended Roller Lever | | | |
|  Extended Roller Lever | | | |
| Screw terminal | OF max.—5.64 oz (160g) RF min.—0.78 oz (22g) PT max.—0.28 in (7.1 mm) OT max.—0.16 in (4 mm) | E47BMS42 | E47CMS42 |
| Solder terminal | MD max.—0.04 in (1.02 mm) FP max.—1.437 in (36.5 mm) OP—1.189 in (30.2 mm) | E47BML42 | — |
| Roller Lever | | | |
|  Roller Lever | | | |
| Screw terminal | OF max.—5.64 oz (160g) RF min.—1.48 oz (42g) PT max.—0.106 in (2.7 mm) OT max.—0.094 in (2.4 mm) | E47BMS30 | E47CMS30 |
| Solder terminal | MD max.—0.02 in (0.5 mm) | E47BML30 | — |
| Spade terminal | FP max.—1.28 in (32.5 mm) OP—1.189 in (30.2 mm) | E47BMT30 | E47CMT30 |
| One-Way Roller | | | |
|  One-Way Roller | | | |
| Screw terminal | OF max.—5.64 oz (160g) RF min.—1.48 oz (42g) PT max.—0.106 in (2.7 mm) OT max.—0.094 in (2.4 mm) | E47BMS31 | — |
| Solder terminal | MD max.—0.02 in (0.5 mm) FP—1.717 in (43.6 mm) OP—1.697 in (43.1 mm) | E47BML31 | — |
| Integral Leaf | | | |
|  Integral Leaf | | | |
| Screw terminal | OF max.—0.35 oz (10g) RF min.—0.106 oz (3.0g) PT max.—0.787 in (20.0 mm) OT max.—0.22 in (5.6 mm) | E47BMS23 | E47CMS23 |
| Solder terminal | MD max.—0.118 in (3.0 mm) OP—0.748 in (19.0 mm) | E47BML23 | — |

Note







^① OF = Operating Force; RF = Return Force; PT = Pre-Travel; OT = Over-Travel; MD = Movement Differential; FP = Free Position; OP = Operating Position.

E47 Precision Switches—Basic, continued

| Type | Specifications ^① | 15A Catalog Number | 20A Catalog Number |
|--|--|-----------------------|-----------------------|
| Adjustable Roller | Adjustable Roller | | |
|  Screw terminal | OF max.—17.64 oz (500g) RF min.—6.0 oz (170g) PT max.—0.197 in (5.0 mm) OT max.—0.5 in (12.7 mm) | E47BMS40 | — |
| Solder terminal | MD max.—0.087 in (2.2 mm) FP max.—1.752 in (44.5 mm) OP—1.591 in (40.4 mm) | E47BML40 | — |
| Extended Adjustable Roller | Extended Adjustable Roller | | |
|  Screw terminal | OF max.—21.16 oz (600g) RF min.—10.58 oz (300g) PT max.—0.118 in (3.0 mm) OT max.—0.236 in (6.0 mm) | E47BMS43 | — |
| Solder terminal | MD max.—0.079 in (2.0 mm) FP max.—1.614 in (41 mm) OP—1.591 in (40.4 mm) | E47BML43 | — |

Enclosed Switches

E47 Precision Switches—Enclosed

| Specifications ^① | Catalog Number | Specifications ^① | Catalog Number |
|---|-------------------------------|--|------------------------------|
| Plunger Actuator | Plunger Actuator | Booted Roller Lever | Booted Roller Lever |
|  OF max.—8.82–12.3 oz (250–350g) RF min.—4.02 oz (114g) PT max.—0.016 in (0.4 mm) OT max.—0.217 in (5.5 mm) MD max.—0.002 in (0.05 mm) OP—1.504 in (38.2 mm) | E47BLS05 |  OF max.—22.57 oz (640g) RF min.—8.11 oz (230g) PT max.—0.197 in (5.0 mm) OT max.—0.236 in (6.0 mm) MD max.—0.016 in (0.4 mm) | E47BLS33 |
| | E47CLS05 ^{②③} | | |
| Booted Plunger | Booted Plunger | Roller Plunger | Roller Plunger |
|  OF max.—28.22 oz (800g) RF min.—8.46 oz (240g) PT max.—0.079 in (2.0 mm) OT max.—0.197 in (5.0 mm) MD max.—0.004 in (0.1 mm) OP—1.803 in (45.8 mm) | E47BLS06 |  OF max.—8.82–12.3 oz (250–350g) RF min.—4.02 oz (114g) PT max.—0.02 in (0.5 mm) OT max.—0.142 in (3.6 mm) MD max.—0.002 in (0.05 mm) OP—1.957 in (49.7 mm) | E47BLS07 |
| | E47CLS06 ^{②③} | | E47BLS11 ^④ |
| Roller Lever | Roller Lever | Booted Roller Plunger | Booted Roller Plunger |
|  OF max.—20.1 oz (570g) RF min.—6.0 oz (170g) PT max.—0.157 in (4.0 mm) OT max.—0.236 in (6.0 mm) MD max.—0.016 in (0.4 mm) | E47BLS32 |  OF max.—17.64 oz (500g) RF min.—3.53 oz (100g) PT max.—0.039 in (1.0 mm) OT max.—0.138 in (3.5 mm) MD max.—0.005 in (0.12 mm) OP—1.957 in (49.7 mm) | E47BLS08 |
| | E47CLS32 ^{②③} | | E47BLS12 ^④ |

Notes

- ① OF = Operating Force; RF = Return Force; PT = Pre-Travel; OT = Over-Travel; MD = Movement Differential; FP = Free Position; OP = Operating Position.
- ② Contact Eaton's Sensor Applications Department at 1-800-426-9184 for approval status.
- ③ 20 ampere version.
- ④ Cross roller unit.



2.1

Limit Switches

E47 Precision Switches

2

E47 Precision Switches—Enclosed, continued

| Specifications ① | Catalog Number |
|--|-----------------|
| One-Way Roller  | |
| One-Way Roller OF max.—20.1 oz (570g) RF min.—6.0 oz (170g) PT max.—0.157 in (4.0 mm) OT max.—0.236 in (6.0 mm) MD max.—0.016 in (0.4 mm) | E47BLS34 |
| Booted One-Way Roller  | |
| Booted One-Way Roller OF max.—22.57 oz (640g) RF min.—8.11 oz (230g) PT max.—0.197 in (5.0 mm) OT max.—0.236 in (6.0 mm) MD max.—0.016 in (0.4 mm) | E47BLS35 |

E47 Precision Switches—Enclosed, continued

| Specifications ① | Catalog Number |
|--|-----------------|
| Booted Wobble  | |
| Booted Wobble OF max.—2.11 oz (60g) RF min.—0.88 oz (25g) PT max.—0.520 in (13.2 mm) OT max.—0.315 in (8.0 mm) MD max.—0.039 in (1.0 mm) | E47BLS14 |

Accessories

Terminal Wire Covers for Basic Switches

| Description | Catalog Number | Description | Catalog Number |
|---|---|---|---|
| 45°  | Terminal wire cover with 45° conduit interface E47PA1 | 90°  | Terminal wire cover with 90° conduit interface E47PA2 |

Technical Data and Specifications

E47 Precision Switches

| Description | Specification |
|---|---------------------------------|
| Operating speed | 0.01m/second to 1m/second |
| Operating Frequency | |
| Mechanical | 120 operations/minute |
| Electrical | 20 operations/minute |
| Mechanical life | 3,000,000 operations minimum |
| Electrical life | 500,000 operations minimum |
| Contact resistance | 15M ohms maximum, initial |
| Insulation resistance | 100M ohms minimum at 500 Vdc |
| Dielectric Strength | |
| Between non-current carrying parts | 1000 Vac, 50/60 Hz for 1 minute |
| Between current carrying parts and ground | 2000 Vac, 50/60 Hz for 1 minute |

Notes

- ① OF = Operating Force; RF = Return Force; PT = Pre-Travel; OT = Over-Travel; MD = Movement Differential; FP = Free Position; OP = Operating Position.
- ② Cross roller unit.

E47 Precision Switches, continued

| Description | Specification |
|---------------------------------------|---|
| Ambient Operating Temperature | |
| Basic | -13° to 176°F (-25° to 80°C) |
| Enclosed | 5° to 176°F (-15° to 80°C) |
| Environmental rating enclosed, booted | NEMA 1 |
| Mounting centers | 1.0 in (25.4 mm), #8 screw size |
| Terminal screws | Bottom facing M4 x 0.7 (8-32) Screws with cup washers will accept 22-12 AWG (2.5 sq. mm maximum) Maximum torque: 10 in-lbs. |
| Threaded bushing | 15/32 in |
| Material of construction | Mineral filled phenolic |
| Enclosure rating | Aluminum die casting (ADC-3/A380); Seal boot: nitrile, butyl rubber (NBR) |
| Conduit fitting on enclosed type | 1/2 in NPT |

Maximum Ampere Ratings ^{①②}

| Model | Rated Voltage | Non-Inductive Load (A) | | | Inductive Load (A) | | | Inrush Current (A) | |
|-------|---------------|-----------------------------|-----------------|------|-----------------------------|------------------|------|--------------------|---------|
| | | Resistive Load NC and NO | Lamp Load NC | NO | Inductive Load NC and NO | Motor Load NC | NO | NC | NO |
| 15A | 125 Vac | 15 | 3 | 1.5 | 15 | 5 | 2.5 | 30 max. | 15 max. |
| | 250 Vac | 15 | 2.5 | 1.25 | 15 | 3 | 1.5 | | |
| | 500 Vac | 3 | 1.5 | 0.75 | 2.5 | 1.5 | 0.75 | | |
| | 8 Vdc | 15 | 3 | 1.5 | 15 | 5 | 2.5 | | |
| | 14 Vdc | 15 | 3 | 1.5 | 10 | 5 | 2.5 | | |
| | 30 Vdc | 6 (2) | 3 | 1.5 | 5 | 5 | 2.5 | | |
| | 125 Vdc | 0.4 | 0.4 | 0.4 | 0.05 | 0.05 | 0.05 | | |
| | 250 Vdc | 0.2 | 0.2 | 0.2 | 0.03 | 0.03 | 0.03 | | |
| 20A | 125 Vac | 20 | 7.5 | 7.5 | 20 | 12.5 | 12.5 | 60 max. | 30 max. |
| | 250 Vac | 20 | 7.5 | 7.5 | 20 | 8.3 | 8.3 | | |
| | 500 Vac | 6 | 4 | 4 | 5 | 2 | 2 | | |
| | 8 Vdc | 20 | 3 | 1.5 | 20 | 12.5 | 12.5 | | |
| | 14 Vdc | 20 | 3 | 1.5 | 15 | 12.5 | 12.5 | | |
| | 30 Vdc | 6 | 3 | 1.5 | 5 | 5 | 5 | | |
| | 125 Vdc | 0.5 | 0.5 | 0.5 | 0.05 | 0.05 | 0.05 | | |
| | 250 Vdc | 0.25 | 0.25 | 0.25 | 0.03 | 0.03 | 0.03 | | |

Terminal Configurations

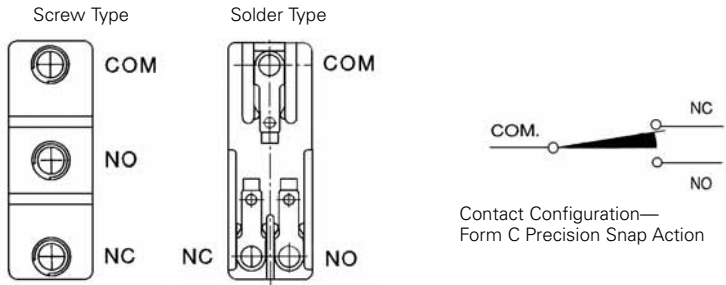

(Spade type not shown, available on some models)

Notes

- ① Inductive load has a power factor of 0.04 minimum (AC) and a time constant of 7 m/second (DC).
- ② Lamp load has an inrush current of six times steady-state current.

2.1

Limit Switches

E47 Precision Switches

Dimensions

Approximate Dimensions in Inches [mm]

2

Basic Switches

Pin Plunger

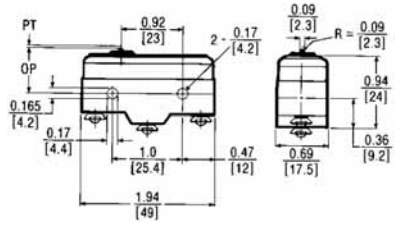

Standard Lever

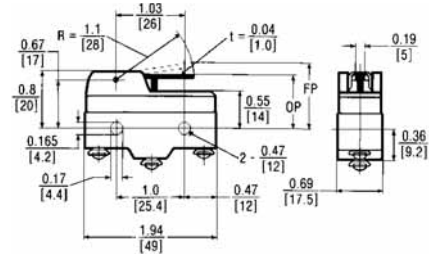

Extended Plunger

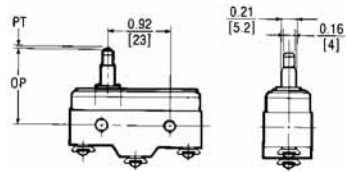

Extended Straight Plunger

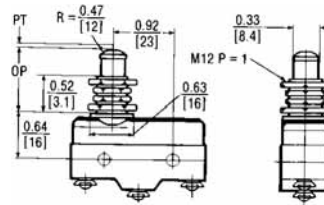

Straight Plunger

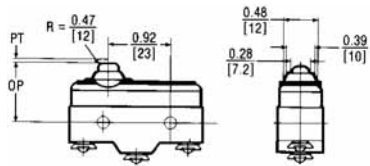

Roller Plunger

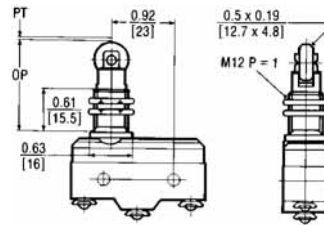

Reversed Lever

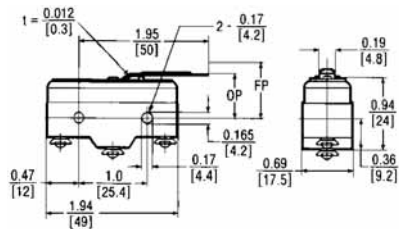

Cross Roller Plunger

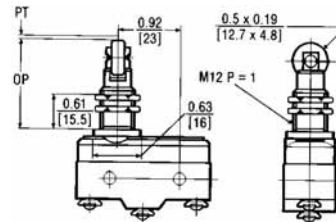

Straight Lever

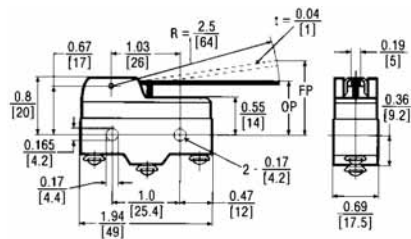

Reversed Roller Lever

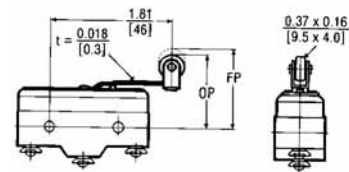

Approximate Dimensions in Inches [mm]

Extended Roller Lever

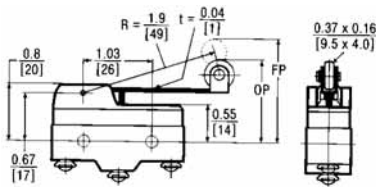

Integral Leaf

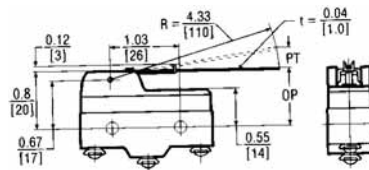

Roller Lever

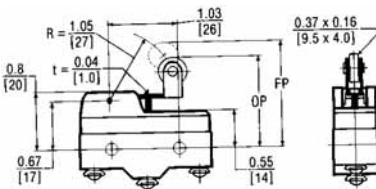

Adjustable Roller

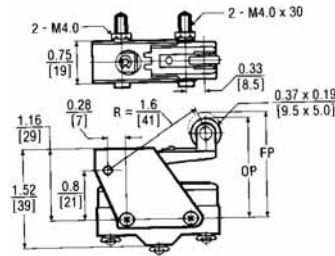

One-Way Roller

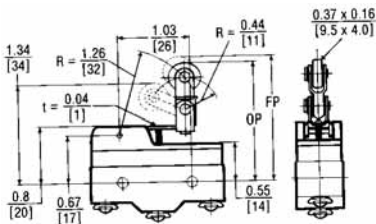

Extended Adjustable Roller

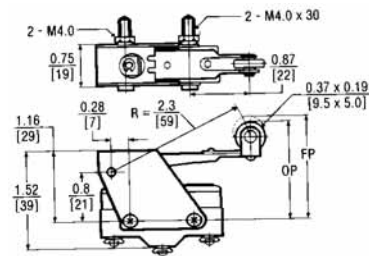

Enclosed Switches

Plunger Actuator

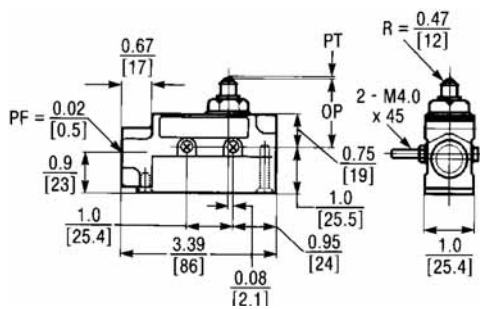

Roller Lever

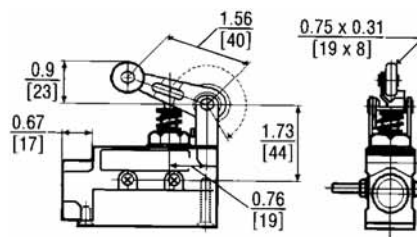

Booted Plunger

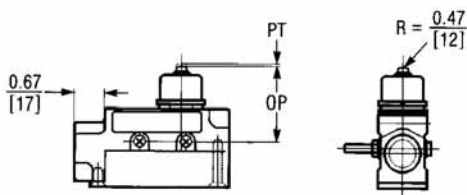

Booted Roller Lever

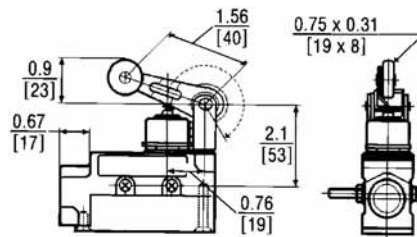

2.1

Limit Switches

E47 Precision Switches

Approximate Dimensions in Inches [mm]

2

Roller Plunger

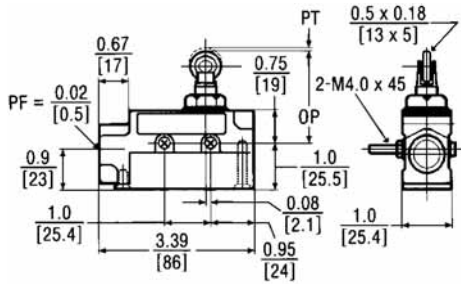

Booted One-Way Roller

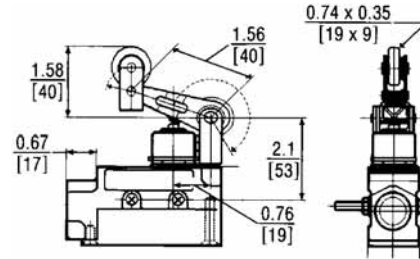

Booted Roller Plunger

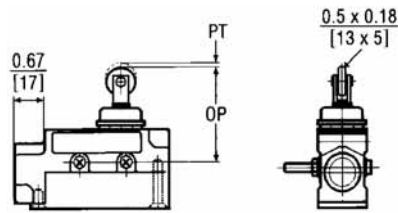

Booted Wobble

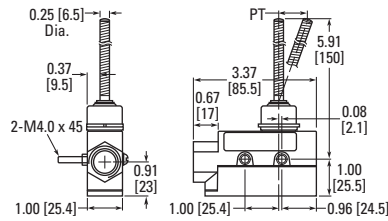

One-Way Roller

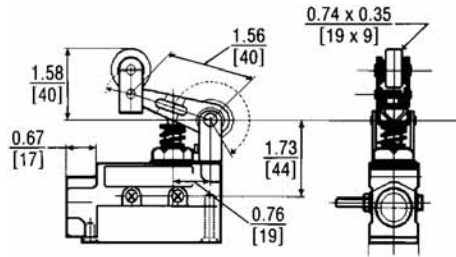

Accessories

Approximate Dimensions in mm

Terminal Wire Cover with 45° Conduit Interface

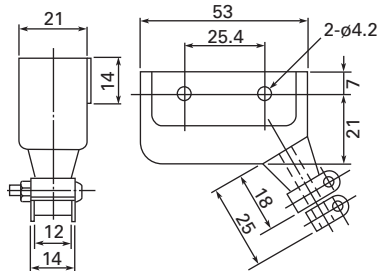

Terminal Wire Cover with 90° Conduit Interface

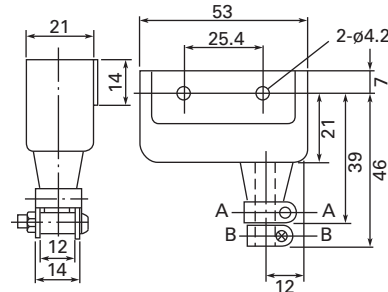

Compact Prewired Switches



Compact Prewired Switches

Product Description

The E47 Compact Prewired Limit Switch by Eaton's electrical sector is designed to be a versatile, slim device for hard to fit applications where sealing integrity is required. The rugged die cast aluminum alloy housing, cable connection and switch mechanism are encapsulated for protection against extreme temperature (-10° to 70°C [14° to 158°F]), contaminants, moisture, shock and vibration. This factory wired (3m) device has NEMA® enclosure ratings of 4, 6 and 13, making it suitable for applications such as machine tool, food processing and packaging.

Features

- Rugged aluminum alloy die cast housing
- Sealed construction with enclosure ratings of NEMA 4, 6 and 13
- Prewired with 3m of 18 AWG, AWM 2517, 300V cable, or micro-connector version also available
- Stackable ridge for ganged operation

Contents

Description

| Description | Page |
|---|----------|
| Compact Prewired Switches | |
| Product Selection | V8-T2-16 |
| Technical Data and Specifications | V8-T2-18 |
| Wiring Diagram | V8-T2-18 |
| Dimensions | V8-T2-19 |

Drawings
Online

Standards and Certifications

- cULus (cable versions only)
- UL (cable versions only)
- NEMA 4, 6 and 13
- IEC IP67, IP69K
- RoHS

 **DANGER**

THIS SENSOR IS NOT A SAFETY DEVICE AND IS NOT INTENDED TO BE USED AS A SAFETY DEVICE. This sensor is designed only to detect and read certain data in an electronic manner and perform no use apart from that, specifically no safety-related use. This sensor product does not include self-checking redundant circuitry, and the failure of this sensor product could cause either an energized or de-energized output condition, which could result in death, serious bodily injury, or property damage.

For the most current information on this product, visit our Web site: www.eaton.com

For Customer Service in the U.S. call 1-877-ETN CARE (386-2273), in Canada call 1-800-268-3578.

For Application Assistance in the U.S. and Canada call 1-800-426-9184.





Product Selection

2

Compact Prewired Switches

| Actuator Type | Operating Force (Maximum) | Reset Force (Minimum) | Over-Travel (Maximum) | Pre-Travel | Movement Differential (Maximum) | Operating Position | Standard Version Catalog Number | Connector Version Catalog Number |
|---|------------------------------------|-----------------------|-----------------------|---------------------|---------------------------------|---------------------------------|---------------------------------|----------------------------------|
| Pin Plunger  | Pin Plunger | | | | | | | |
| | 42.3 oz (1.2 kg) | 15.9 oz (450g) | 0.118 in (3 mm) | 0.07 in (1.8 mm) | 0.008 in (0.2 mm) | 0.62 ± 0.04 in (15.7 ± 1 mm) | E47BCC05 | E47BCC05P4 |
| Sealed Plunger  | Sealed Plunger | | | | | | | |
| | 63.5 oz (1.8 kg) | 15.9 oz (450g) | 0.118 in (3 mm) | 0.07 in (1.8 mm) | 0.008 in (0.2 mm) | 0.99 ± 0.04 in (24.9 ± 1 mm) | E47BCC06 | E47BCC06P4 |
| Roller Plunger  | Roller Plunger | | | | | | | |
| | 42.3 oz (1.2 kg) | 15.9 oz (450g) | 0.118 in (3 mm) | 0.07 in (1.8 mm) | 0.008 in (0.2 mm) | 1.12 ± 0.04 in (28.5 ± 1 mm) | E47BCC07 | E47BCC07P4 |
| Sealed Roller Plunger  | Sealed Roller Plunger | | | | | | | |
| | 63.5 oz (1.8 kg) | 15.9 oz (450g) | 0.118 in (3 mm) | 0.07 in (1.8 mm) | 0.008 in (0.2 mm) | 1.35 ± 0.04 in (34.3 ± 1 mm) | E47BCC08 | E47BCC08P4 |
| Cross Roller Plunger  | Cross Roller Plunger | | | | | | | |
| | 42.3 oz (1.2 kg) | 15.9 oz (450g) | 0.118 in (3 mm) | 0.07 in (1.8 mm) | 0.008 in (0.2 mm) | 1.12 ± 0.04 in (28.5 ± 1 mm) | E47BCC11 | E47BCC11P4 |
| Sealed Cross Roller Plunger  | Sealed Cross Roller Plunger | | | | | | | |
| | 63.5 oz (1.8 kg) | 15.9 oz (450g) | 0.118 in (3 mm) | 0.07 in (1.8 mm) | 0.008 in (0.2 mm) | 1.35 ± 0.04 in (34.3 ± 1 mm) | E47BCC12 | E47BCC12P4 |
| Bevel Plunger  | Bevel Plunger | | | | | | | |
| | 42.3 oz (1.2 kg) | 15.9 oz (450g) | 0.118 in (3 mm) | 0.07 in (1.8 mm) | 0.008 in (0.2 mm) | 1.12 ± 0.04 in (28.5 ± 1 mm) | E47BCC13 | E47BCC13P4 |

Compact Prewired Switches, continued

| Actuator Type | Operating Force (Maximum) | Reset Force (Minimum) | Over-Travel (Maximum) | Pre-Travel | Movement Differential (Maximum) | Operating Position | Standard Version Catalog Number | Connector Version Catalog Number |
|--|-----------------------------|-----------------------|-----------------------|------------|---------------------------------|--------------------|---------------------------------|----------------------------------|
| Roller Lever  | Roller Lever | | | | | | | |
| | 20.5 oz (580g) | 5.3 oz (150g) | 40° | 25° max. | 3° | — | E47BCC15 | E47BCC15P4 |
| Wobble Stick  | Wobble Stick | | | | | | | |
| | 5.3 oz (150g) | — | — | 15° max. | — | — | E47BCC20 | E47BCC20P4 |
| Rod Lever  | Rod Lever | | | | | | | |
| | 20.5 oz (580g) | 5.3 oz (150g) | 40° | 25° max. | 3° | — | — | E47BCC21P4 |
| Adjustable Level Arm  | Adjustable Level Arm | | | | | | | |
| | 20.5 oz (580g) | 5.3 oz (150g) | 40° | 25° max. | 3° | — | E47BCC22 | E47BCC22P4 |

Technical Data and Specifications

2

Compact Prewired Switches

| Description | Specification |
|-----------------------------|---|
| Contacts | 1-SPDT (Form C) |
| Mechanical life | 10,000,000 operations |
| Electrical life | 200,000 operations, 30 operation/min. at rated load |
| Operating speed | 30 operations per minute maximum |
| Operating temperature range | -10° to 70°C (14° to 158°F) |
| Storage temperature range | -10° to 70°C (14° to 158°F) |
| Humidity | 95% maximum non-condensing |
| Vibration | Malfunction durability, 10 to 55 Hz 1.5 mm double amplitude |
| Shock | Malfunction durability, approximately 50G |
| Enclosure ratings | NEMA 4, 6 and 13; IEC IP67 |

Maximum Ampere Ratings ^①

| Rated Voltage | Non-Inductive Load (A) | | Inductive Load (A) | | Motor Load | | Inrush Current (A) | |
|---------------|------------------------|-----|--------------------|-----|------------|------|--------------------|---------|
| | NC | NO | NC | NO | NC | NO | NC | NO |
| 125 Vac | 5 | 5 | 3 | 3 | 2.5 | 1.3 | 20 max. | 10 max. |
| 250 Vac | 5 | 5 | 2 | 2 | 1.5 | 0.8 | | |
| 8 Vdc | 5 | 5 | 5 | 4 | 1.5 | 1.5 | | |
| 14 Vdc | 5 | 5 | 4 | 4 | 1.5 | 1.5 | | |
| 30 Vdc | 4 | 4 | 3 | 3 | 1.5 | 1.5 | | |
| 125 Vdc | 0.4 | 0.4 | 0.4 | 0.4 | 0.05 | 0.05 | | |
| 250 Vdc | 0.2 | 0.2 | 0.2 | 0.2 | 0.03 | 0.03 | | |

Wiring Diagram

Compact Prewired Switches

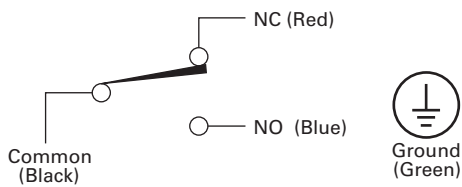

Micro-Connector Switches

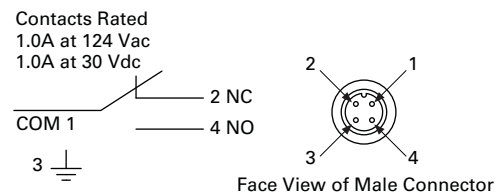

Note

^① Inductive load ratings are tested at a power factor 0.4 min. for AC power and a time constant of 7 ms max. for DC power. Inrush current for motor load is six times the steady state current.

2.2

Limit Switches

Compact Prewired Switches

Approximate Dimensions in mm [in]

E47BCC20

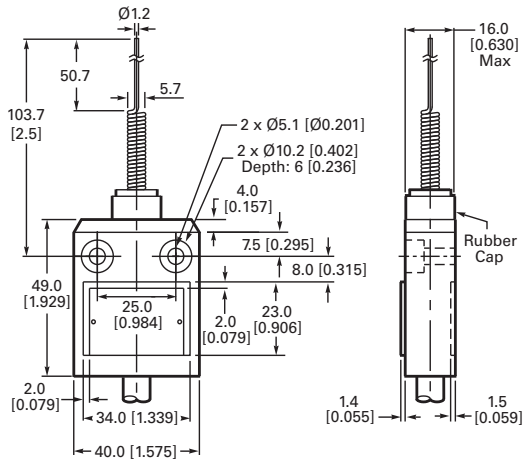

E47BCC22

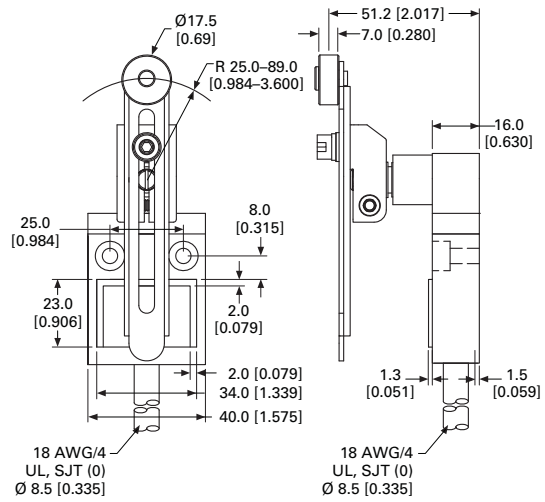

E47BCC21

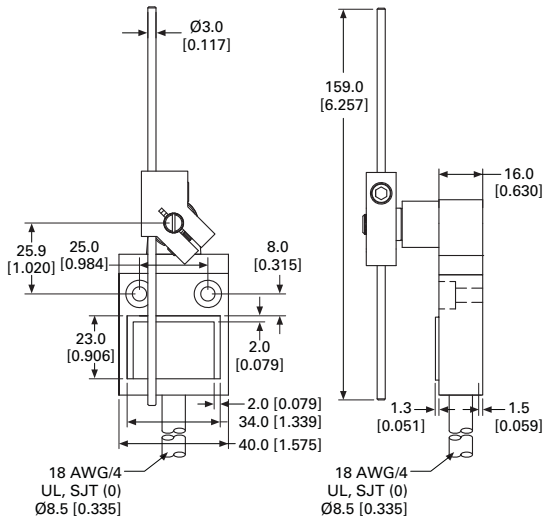

LS-Titan Miniature DIN Switches



Contents

| <i>Description</i> | <i>Page</i> |
|--|-----------------|
| LS-Titan Miniature DIN Switches | |
| Product Identification | V8-T2-22 |
| Product Selection | V8-T2-23 |
| LS-Titan Plastic Safety Switches | V8-T2-23 |
| LS-Titan Plastic Electronic Safety Position Switches | V8-T2-26 |
| LS-Titan Metal Safety Switches | V8-T2-30 |
| Understanding LS-Titan Electronic Safety Position Switches | V8-T2-32 |
| Operating Point Adjustment | V8-T2-32 |
| Accessories | V8-T2-33 |
| Technical Data and Specifications | V8-T2-34 |
| Contact Travel Diagrams | V8-T2-37 |
| Dimensions | V8-T2-40 |

LS-Titan Miniature DIN Switches

Product Description

Eaton’s LS-Titan™ limit switch line is a complete offering of safety position switches designed for worldwide application. Economical insulated plastic or rugged metal enclosures and modular, plug-in operating heads and bodies make LS-Titan a flexible switching solution.

A highlight of the LS-Titan switch line is the world’s first electronic position switch (LSE models). These switches feature freely programmable operating points that can be set individually at any time. Additional LSE models provide analog outputs proportional to the actuator position.

LS-Titan switches are suitable for use in safety applications designed to protect persons or processes.

Features

- Modular, plug-in system (head and body components)
- Positive opening NC contacts for safety applications
- Wide variety of economical plastic and rugged metal versions available
- Operating heads can be rotated 90 degrees to suit specific direction of operation
- Unique electronic safety position switches (LSE models) provide analog (0–10 Vdc or 4–20 mA) outputs proportional to the actuator position and allow for easy configuration of a custom trip point
- Can be ordered as separate components (head and body) or as completely assembled switches
- Screw and Cage Clamp® (standard on LSE models and optionally available on mechanical models) connections provide larger wiring areas for easier installation
- Approved for worldwide application

Standards and Certifications

- Safety function by positive opening contacts per IEC/EN 60947-5-1 up to Category 4 per EN 954-1
- TÜV-Rheinland Certified for Functional-Safety (LSE models)
- CSA certified
- UL listed
- CE
- CCC



Note: Cage Clamp is a registered trademark of Wago Kontakttechnik, 32423 Minden, Germany.

For the most current information on this product, visit our Web site: www.eaton.com

For Customer Service in the U.S. call 1-877-ETN CARE (386-2273), in Canada call 1-800-268-3578. For Application Assistance in the U.S. and Canada call 1-800-426-9184.

Product Identification

2

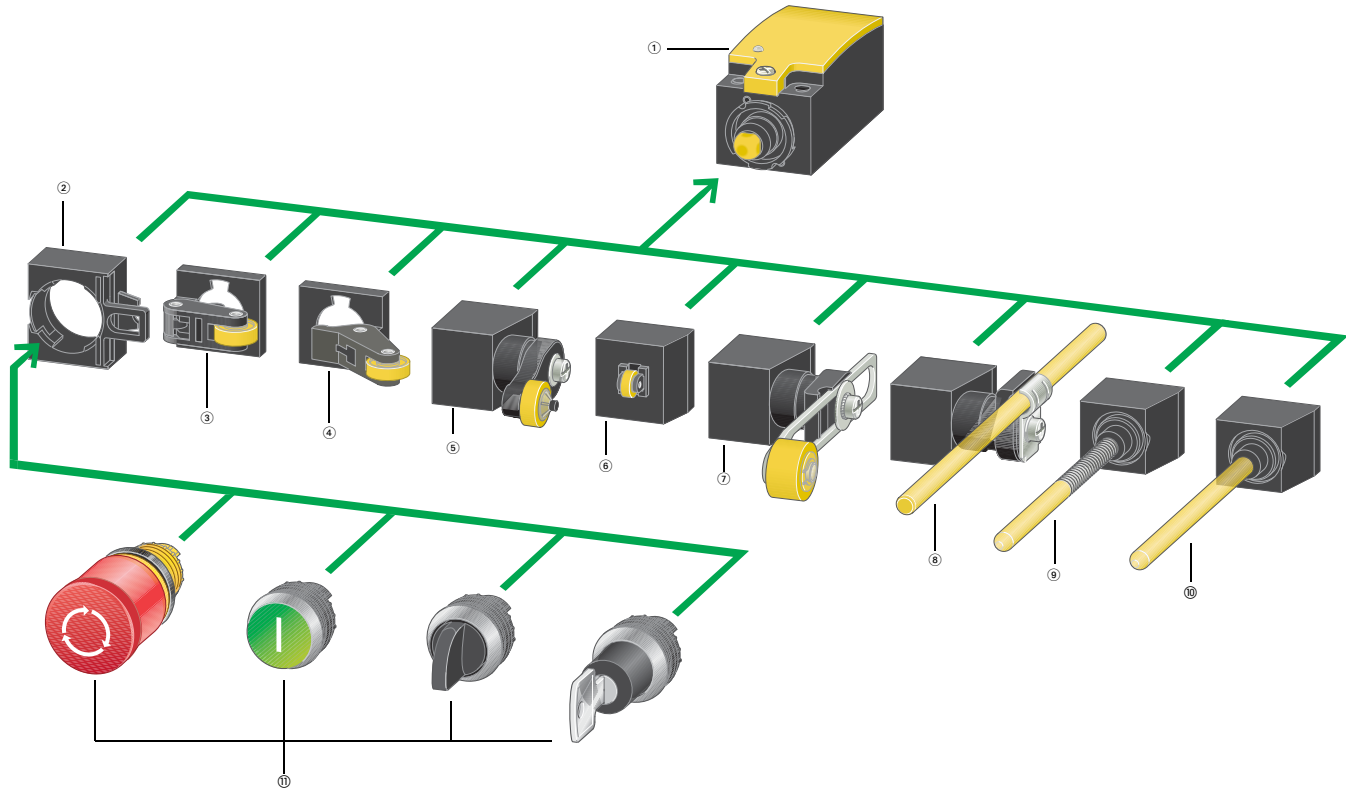

Notes

① Basic device

(see Pages V8-T2-23 to V8-T2-31)
According to EN 50047
With screw-on cover
Contacts: 1NO-1NC, 2NO, 2NC
Cage Clamp, screw terminal
As snap-action or standard-action switch
As electronic snap-action switch
(individually adjustable)
As 4–20 mA analog signal encoder
As 0–10 Vdc analog signal encoder

② Fixing adapter (see Page V8-T2-33)

Allows mounting of M22 pushbuttons

③ Roller lever

(see Pages V8-T2-23 and V8-T2-26)

For one-sided operation with higher operating speed

④ Angled roller lever (see Pages V8-T2-23, V8-T2-26 and V8-T2-30)

For actuation along the unit axis

⑤ Rotary lever (see Pages V8-T2-23, V8-T2-27 and V8-T2-30)

For actuation from the side, for pendulum movements

⑥ Roller plunger (see Pages V8-T2-23, V8-T2-26 and V8-T2-30)

For actuation from the side with low actuating force

⑦ Adjustable roller lever (see Pages V8-T2-24, V8-T2-27, V8-T2-28 and V8-T2-30)

For length adjustment as required

⑧ Actuating rod (see Pages V8-T2-25, V8-T2-29 and V8-T2-31)

On conveyor belts for lightweight goods

⑨ Spring-rod (see Pages V8-T2-25, V8-T2-29 and V8-T2-31)

For flexible actuation from all sides

j Actuating rod (see Pages V8-T2-25, V8-T2-29 and V8-T2-31)

Withdrawable mechanism from front

k Pushbuttons from the M22 family; see M22 catalog (CA04716001E) or www.eaton.com/m22

Operating heads can be rotated by 90 degrees.

Product Selection

LS-Titan Plastic Safety Switches

| | | Plastic Safety Switches | | | |
|--------------------------------|---------------------------------|--|------------------------------------|--------------------------|---|
| | | Switch Body Catalog Number | LS-S02 | LS-S20A | LS-S11S |
| | | Output Function | 2NC with positive opening contacts | 2NO with slow make/break | 1NO and 1NC with positive opening contact |
| | | Terminal Connection | Screw terminal ① | Screw terminal ① | Screw terminal ① |
| | | Contact Sequence | | | |
| | | Contact Travel | | | |
| | | Operating Head Type ② | | | |
| | Head Only Catalog Number | Assembled Switch Catalog Number | | | |
| Top Push Roller Plunger | LS-XP | LS-S02-P | LS-S20A-P | LS-S11S-P | |
| Long Roller Lever | LS-XL | LS-S02-L | LS-S20A-L | LS-S11S-L | |
| Short Roller Lever | LS-XLS | LS-S02-LS | LS-S20A-LS | LS-S11S-LS | |
| Large Roller Lever | LS-XLB | LS-S02-LB | LS-S20A-LB | LS-S11S-LB | |
| Angled Roller | LS-XLA | LS-S02-LA | LS-S20A-LA | LS-S11S-LA | |
| Rotary Lever | LS-XRL | LS-S02-RL | LS-S20A-RL | LS-S11S-RL | |

Notes

- ① Cage Clamp versions available. Contact Application Engineering.
- ② For operating head dimensions, see **Page V8-T2-40**.

2.3

Limit Switches

LS-Titan Miniature DIN Switches

2

Plastic Safety Switch Body



Assembled Switch



Plastic Safety Switches, continued

Switch Body Catalog Number

Output Function

Terminal Connection

Contact Sequence

Contact Travel

■ = contact closed
□ = contact open

Operating Head Type ②

Head Only Catalog Number

LS-S02

2NC with positive opening contacts

Screw terminal ①

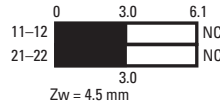

LS-S20A

2NO with slow make/break

Screw terminal ①

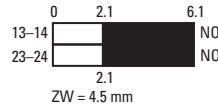

LS-S11S

1NO and 1NC with positive opening contact

Screw terminal ①

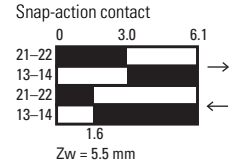

Assembled Switch Catalog Number

Adjustable Roller Lever (with 18 mm Roller)



LS-XRLA

LS-S02-RLA

LS-S20A-RLA

LS-S11S-RLA

Adjustable Roller Lever (with 30 mm Roller)



LS-XRLA30

LS-S02-RLA30

LS-S20A-RLA30

LS-S11S-RLA30

Adjustable Roller Lever (with 40 mm Roller)



LS-XRLA40

LS-S02-RLA40

LS-S20A-RLA40

LS-S11S-RLA40

Adjustable Roller Lever (with 40 mm Rubber Roller)



LS-XRLA40R

LS-S02-RLA40R

LS-S20A-RLA40R

LS-S11S-RLA40R

Notes

- ① Cage Clamp versions available. Contact Application Engineering.
- ② For operating head dimensions, see **Page V8-T2-40**.

Plastic Safety Switches, continued

Plastic Safety Switch Body



Assembled Switch



Switch Body Catalog Number

Output Function

Terminal Connection

Contact Sequence

Contact Travel

- = contact closed
- = contact open

Operating Head Type ②

Head Only Catalog Number

LS-S02

2NC with positive opening contacts

Screw terminal ①

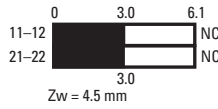

LS-S20A

2NO with slow make/break

Screw terminal ①

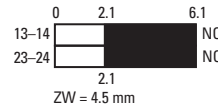

LS-S11S

1NO and 1NC with positive opening contact

Screw terminal ①

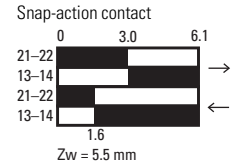

Assembled Switch Catalog Number

Plastic Rod Lever



LS-XRR

LS-S02-RR

LS-S20A-RR

LS-S11S-RR

Metal Rod



LS-XRRM

LS-S02-RRM

LS-S20A-RRM

LS-S11S-RRM

Spring Rod (Wobble) ③



LS-XS

LS-S02-S

LS-S20A-S

LS-S11S-S

Actuating Rod



LS-XOR

LS-S02-OR

LS-S20A-OR

LS-S11S-OR

Notes

- ① Cage Clamp versions available. Contact Application Engineering.
- ② For operating head dimensions, see Page V8-T2-40.
- ③ Not to be used as a safety position switch. Use only in conjunction with snap-action contact.

2.3

Limit Switches

LS-Titan Miniature DIN Switches

LS-Titan Plastic Electronic Safety Position Switches

2

Plastic Electronic Safety Position Switch Body



Assembled Switch



Plastic Electronic Safety Position Switches

Switch Body

Catalog Number

LSE-11

LSE-02

LSE-AI

LSE-AU

Output Function

1NO and 1 NC

2NC

Analog 4–20 mA

Analog 0–10V

Terminal Connections

Cage Clamp ①

Cage Clamp ①

Cage Clamp ①

Cage Clamp ①

Safety Functions and Approvals

These models may be used in safety-oriented circuits. Visual status LED indication is comparable to positive opening contacts. Certified by TÜV as a "Functional-Safety" device. Suitable for protection of people or processes.

Additional diagnostic output that registers a 0V signal in the event of a fault. Self-test function continuously tests both outputs for overloads, short circuits to 0V and short circuits to +U_e. Certified by TÜV to EN 954-1, Category 3 or 4. Suitable for protection of people or processes.



Contact Sequence

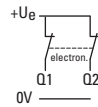
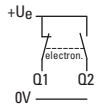

Analog 4–20 mA

Analog 0–10V

Contact Travel

■ = contact closed

□ = contact open

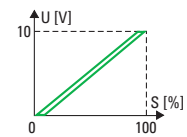
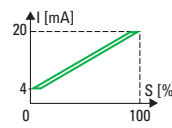
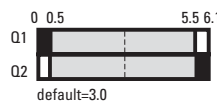
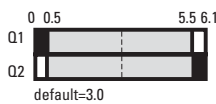

Operating Head Type ②

Head Only

Catalog Number

Assembled Switch

Catalog Number

Top Push Roller Plunger



LS-XP

LSE-11-P

LSE-02-P

LSE-AI-P

LSE-AU-P

Long Roller Lever



LS-XL

LSE-11-L

LSE-02-L

LSE-AI-L

LSE-AU-L

Short Roller Lever



LS-XLS

LSE-11-LS

LSE-02-LS

LSE-AI-LS

LSE-AU-LS

Large Roller Lever



LS-XLB

LSE-11-LB

LSE-02-LB

LSE-AI-LB

LSE-AU-LB

Angled Roller



LS-XLA

LSE-11-LA

LSE-02-LA

LSE-AI-LA

LSE-AU-LA

Notes

① A compatible Cage Clamp tool is available as an accessory on [Page V8-T2-33](#).

② For operating head dimensions, see [Page V8-T2-40](#).

Plastic Electronic Safety Position Switches, continued

Plastic Electronic Safety Position Switch Body



Assembled Switch



| Switch Body Catalog Number | LSE-11 | LSE-02 | LSE-AI | LSE-AU |
|---------------------------------------|--|--------------|--|--------------|
| Output Function | 1NO and 1NC | 2NC | Analog 4–20 mA | Analog 0–10V |
| Terminal Connections | Cage Clamp ① | Cage Clamp ① | Cage Clamp ① | Cage Clamp ① |
| Safety Functions and Approvals | These models may be used in safety-oriented circuits. Visual status LED indication is comparable to positive opening contacts. Certified by TÜV as a “Functional-Safety” device. Suitable for protection of people or processes. | | Additional diagnostic output that registers a 0V signal in the event of a fault. Self-test function continuously tests both outputs for overloads, short circuits to 0V and short circuits to +U _e . Certified by TÜV to EN 954-1, Category 3 or 4. Suitable for protection of people or processes. | |



Contact Sequence

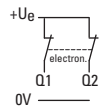
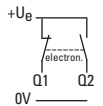

Analog 4–20 mA

Analog 0–10V

Contact Travel

■ = contact closed
□ = contact open

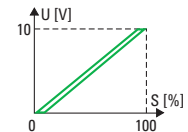
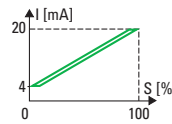
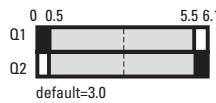
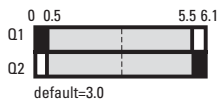

Operating Head Type ②

| Head Only Catalog Number | Assembled Switch Catalog Number |
|--------------------------|---------------------------------|
|--------------------------|---------------------------------|

Rotary Lever



| LS-XRL | LSE-11-RL | LSE-02-RL | LSE-AI-RL | LSE-AU-RL |
|--------|-----------|-----------|-----------|-----------|
|--------|-----------|-----------|-----------|-----------|

Adjustable Roller Lever (with 18 mm Roller)



| LS-XRLA | LSE-11-RLA | LSE-02-RLA | LSE-AI-RLA | LSE-AU-RLA |
|---------|------------|------------|------------|------------|
|---------|------------|------------|------------|------------|

Adjustable Roller Lever (With 30 mm Roller)



| LS-XRLA30 | LSE-11-RLA30 | LSE-02-RLA30 | LSE-AI-RLA30 | LSE-AU-RLA30 |
|-----------|--------------|--------------|--------------|--------------|
|-----------|--------------|--------------|--------------|--------------|

Notes

- ① A compatible Cage Clamp tool is available as an accessory on Page V8-T2-33.
- ② For operating head dimensions, see Page V8-T2-40.

2.3

Limit Switches

LS-Titan Miniature DIN Switches

2

Plastic Electronic Safety Position Switch Body



Assembled Switch



Plastic Electronic Safety Position Switches, continued

Switch Body

Catalog Number

LSE-11

LSE-02

LSE-AI

LSE-AU

Output Function

1NO and 1NC

2NC

Analog 4–20 mA

Analog 0–10V

Terminal Connections

Cage Clamp ①

Cage Clamp ①

Cage Clamp ①

Cage Clamp ①

Safety Functions and Approvals

These models may be used in safety-oriented circuits. Visual status LED indication is comparable to positive opening contacts. Certified by TÜV as a "Functional-Safety" device. Suitable for protection of people or processes.

Additional diagnostic output that registers a 0V signal in the event of a fault. Self-test function continuously tests both outputs for overloads, short circuits to 0V and short circuits to +U_e. Certified by TÜV to EN 954-1, Category 3 or 4. Suitable for protection of people or processes.



Contact Sequence

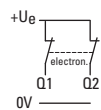
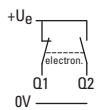

Analog 4–20 mA

Analog 0–10V

Contact Travel

■ = contact closed
□ = contact open

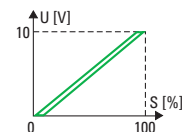
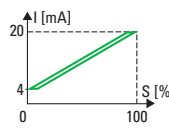
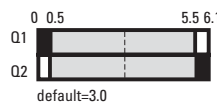
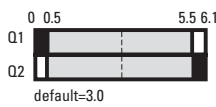

Operating Head Type ②

Head Only Catalog Number

Assembled Switch Catalog Number

Adjustable Roller Lever (With 40 mm Roller)



LS-XRLA40

LSE-11-RLA40

LSE-02-RLA40

LSE-AI-RLA40

LSE-AU-RLA40

Adjustable Roller Lever (With 40 mm Roller)



LS-XRLA40R

LSE-11-RLA40R

LSE-02-RLA40R

LSE-AI-RLA40R

LSE-AU-RLA40R

Plastic Rod Lever



LS-XRR

LSE-11-RR

LSE-02-RR

LSE-AI-RR

LSE-AU-RR

Notes

- ① A compatible Cage Clamp tool is available as an accessory on [Page V8-T2-33](#).
- ② For operating head dimensions, see [Page V8-T2-40](#).

Plastic Electronic Safety Position Switches, continued

Plastic Electronic Safety Position Switch Body



| Switch Body Catalog Number | LSE-11 | LSE-02 | LSE-AI | LSE-AU |
|---------------------------------------|--|--------------|--|--------------|
| Output Function | 1NO and 1NC | 2NC | Analog 4–20 mA | Analog 0–10V |
| Terminal Connections | Cage Clamp ① | Cage Clamp ① | Cage Clamp ① | Cage Clamp ① |
| Safety Functions and Approvals | These models may be used in safety-oriented circuits. Visual status LED indication is comparable to positive opening contacts. Certified by TÜV as a “Functional-Safety” device. Suitable for protection of people or processes. | | Additional diagnostic output that registers a 0V signal in the event of a fault. Self-test function continuously tests both outputs for overloads, short circuits to 0V and short circuits to +U _e . Certified by TÜV to EN 954-1, Category 3 or 4. Suitable for protection of people or processes. | |

Assembled Switch



| Operating Head Type ② | Head Only Catalog Number | Assembled Switch Catalog Number | LS-XRRM | LSE-11-RRM | LSE-02-RRM | LSE-AI-RRM | LSE-AU-RRM |
|---------------------------|--------------------------|---------------------------------|---------|------------|------------|------------|------------|
| Contact Sequence | | | | | | | |
| Contact Travel | | | | | | | |
| Legend | | | | | | | |
| Performance Graphs | | | | | | | |

Metal Rod



Spring Rod (Wobble) ③



Actuating Rod



Notes

- ① A compatible Cage Clamp tool is available as an accessory on **Page V8-T2-33**.
- ② For operating head dimensions, see **Page V8-T2-40**.
- ③ Not to be used as a safety position switch. Use only in conjunction with snap-action contact.

2.3

Limit Switches

LS-Titan Miniature DIN Switches

LS-Titan Metal Safety Switches

2

Metal Safety Switch Body



Assembled Switch



Metal Safety Switches

Switch Body Catalog Number

Output Function

Terminal Connection

Contact Sequence

Contact Travel

■ = contact closed

□ = contact open

Operating Head Type ①

Head Only Catalog Number

LSM-02

2NC with positive opening contacts

Cage Clamp

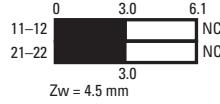

LSM-20A

2NO with slow make/break

Cage Clamp

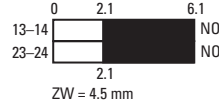

LSM-11S

1NO and 1NC with positive opening contact

Cage Clamp



Snap-action contact

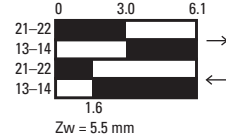

Top Push Roller Plunger



LSM-XP

LSM-02-P

LSM-20A-P

LSM-11S-P

Long Roller Lever



LSM-XL

LSM-02-L

LSM-20A-L

LSM-11S-L

Angled Roller



LSM-XLA

LSM-02-LA

LSM-20A-LA

LSM-11S-LA

Rotary Lever



LSM-XRL

LSM-02-RL

LSM-20A-RL

LSM-11S-RL

Adjustable Roller Lever



LSM-XRLA

LSM-02-RLA

LSM-20A-RLA

LSM-11S-RLA

Note

① For operating head dimensions, see **Page V8-T2-40**.

Metal Safety Switches, continued

Metal Safety Switch Body



Assembled Switch



Switch Body Catalog Number

Output Function

Terminal Connection

Contact Sequence

Contact Travel

- = contact closed
- = contact open

Operating Head Type ①

Head Only Catalog Number

LSM-02

2NC with positive opening contacts

Cage Clamp

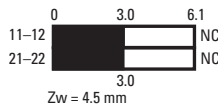

LSM-20A

2NO with slow make/break

Cage Clamp

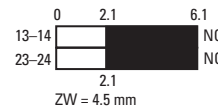

LSM-11S

1NO and 1NC with positive opening contact

Cage Clamp

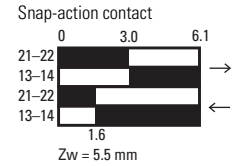

Plastic Rod Lever



LSM-XRR

LSM-02-RR

LSM-20A-RR

LSM-11S-RR

Metal Rod Lever



LSM-XRRM

LSM-02-RRM

LSM-20A-RRM

LSM-11S-RRM

Spring Rod (Wobble)



LSM-XS

LSM-02-S

LSM-20A-S

LSM-11S-S

Note

① For operating head dimensions, see **Page V8-T2-40**.

2.3

Limit Switches

LS-Titan Miniature DIN Switches

2

Understanding LS-Titan Electronic Safety Position Switches

All four LS-Titan LSE switch bodies are safety-rated products. The LSE-11 and LSE-02 switch bodies both have a freely programmable operating point and can be individually adjusted to suit the application, and can be changed as often as required. These devices feature an LED on the body, providing simple indication during programming and operation.

The LSE-AI (4–20 mA) and LSE-AU (0–10V) analog position switches take position data and convert to an analog current or voltage value that can then be continuously fed into an automation system. These two switches also feature a diagnostic output for additional data processing.

This ensures that a safe operating state can be monitored and evaluated at any time. A self-test function is also present on these models. Outputs Q1 and Q2 are continuously tested for overloads, short circuits to 0V and short circuits to +U_e.

Like the electromechanical position switches, LS-Titan electronic position switches meet Category 3 or 4 of the EN 954-1 standard for machine safety when configured as a redundant system. All devices are thus suitable for safety applications that are used for the protection of persons or processes.

Operating Point Adjustment

LSE-11

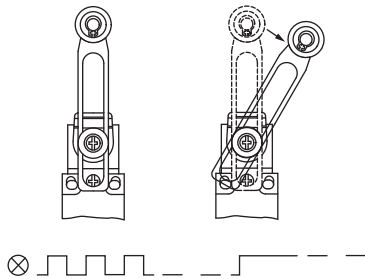

LSE-02

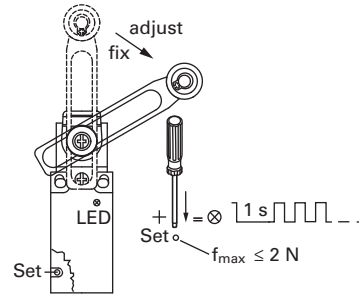

Example of LS-Titan LSE Models in a Safety-Oriented Circuit

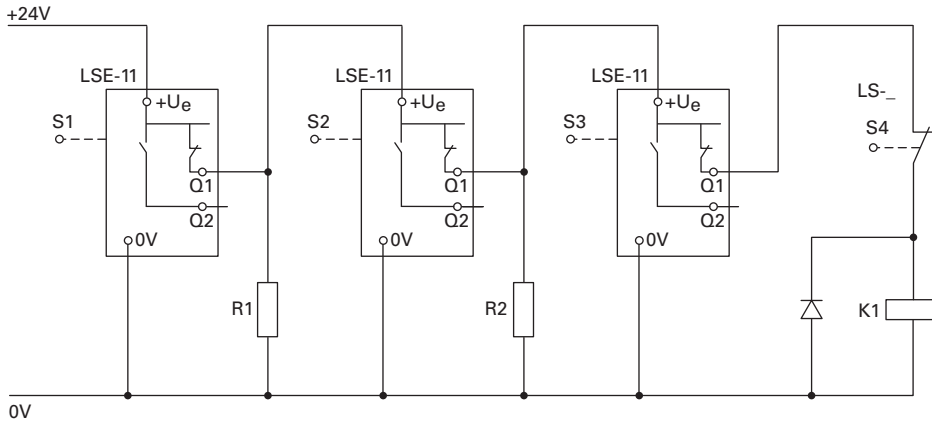

Notes

LSE-11 and LSE-02—individual operating point adjustment.

LSE-11 and LSE-02 can be used in safety circuits.



S1 is connected to 24 Vdc

S2, S3 each switch with a delay of 0.7s

R1, R2, for example, series element M22-XLED60 (2820 ohms/0.5W)

Accessories

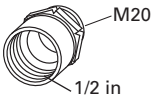
LS-Titan Safety Switches

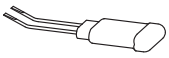
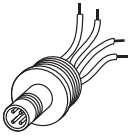
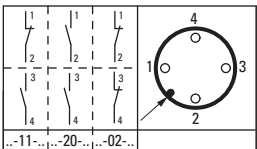
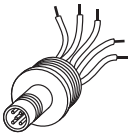
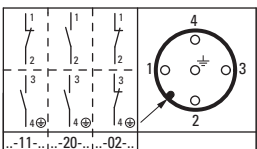
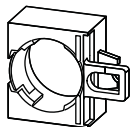
| | For Use With | Description | Notes | Catalog Number |
|--|--------------------------------|---|--|--------------------|
| V1-2-M20  | Any | M20 screw terminal in 1/2 in. For use with American pipe thread, metal. | The screw connection must be earthed. Not total insulation. | V1-2-M20-NA |
| | Any | M20 screw terminal in 1/2 in. For use with American pipe thread, molded material. | — | V1-2-M20 |
| EMS20  | Any | M20 diaphragm bolt. With internal push-through membrane. Will fit cable with an external diameter of up to 13 mm. Rated IP65 with cable inserted. | — | EMS20 |
| LS-XTW  | Any | Cage Clamp tool. | — | LS-XTW |
| M12A  | LS-Titan plastic bodies (LS-_) | Plug connector, 12 mm, 4-pin male connector M12x1 (M12x1). Rated IP65. Molded material. Color coded to IEC/EN 60947-5-2. |  | M12A |
| M12A5  | LS-Titan metal bodies (LSM-_) | Plug connector, 12 mm, 5-pin male connector (M12x1). Rated IP65. Molded material. Color coded to IEC/EN 60947-5-2. |  | M12A5 |
| M22-LS  | Any | Allows mounting of M22 pushbuttons. (See the M22 catalog, CA04716001E, for a full selection of pushbuttons.) | — | M22-LS |

Technical Data and Specifications

LS-Titan Miniature DIN Switches—IP66, IP67 Complete Units

2

| Units | | | LS, LSM | LSE-11/LSE-02 | LSE-AI ① | LSE-AU ① |
|--|--|----------------------|--|--|--|--|
| General | | | | | | |
| Standards | | | IEC/EN 60947 | IEC/EN 60947 EN 61000-4 | IEC/EN 60947 EN 61000-4 | IEC/EN 60947 EN 61000-4 |
| Climatic proofing | | | Damp heat, constant, to IEC 60068-2-78; damp heat, cyclical, to IEC 60068-2-30 | Damp heat, constant, to IEC 60068-2-78; damp heat, cyclical, to IEC 60068-2-30 | Damp heat, constant, to IEC 60068-2-78; damp heat, cyclical, to IEC 60068-2-30 | Damp heat, constant, to IEC 60068-2-78; damp heat, cyclical, to IEC 60068-2-30 |
| Ambient temperature | | °F (°C) | −13° to 158°F (−25° to 70°C) | −13° to 158°F (−25° to 70°C) | −13° to 158°F (−25° to 70°C) | −13° to 158°F (−25° to 70°C) |
| Mounting position | | | As required | As required | As required | As required |
| Protection type | | | IP66, IP67 | IP66, IP67 | IP66, IP67 | IP66, IP67 |
| Terminal capacity of screw terminal and Cage Clamp | | | | | | |
| Solid | | mm ² | 1 x (0.5–2.5) | 1 x (0.5–2.5) | 1 x (0.5–2.5) | 1 x (0.5–2.5) |
| Flexible with ferrules to DIN 46228 | | mm ² | 1 x (0.5–1.5) | 1 x (0.5–1.5) | 1 x (0.5–1.5) | 1 x (0.5–1.5) |
| Power Supply | | | | | | |
| Rated voltage | | U _e Vdc | N/A | 12–30 | 24 (−15%/+20%) | 24 (−15%/+20%) |
| Burden current | | | | | | |
| 12V | | I _e mA | N/A | 15 | N/A | N/A |
| 24V | | I _e mA | N/A | 18 | 28–45 | 24 |
| 30V | | I mA | N/A | 19 | N/A | N/A |
| Contacts/Switching Capacity | | | | | | |
| Rated impulse withstand voltage | | U _{imp} Vac | 4000 | N/A | N/A | N/A |
| Rated insulation voltage | | U _i V | 400 | N/A | N/A | N/A |
| Overvoltage category/ pollution degree | | | III/3 | III/3 | N/A | N/A |
| Rated Operational Current | | | | | | |
| AC-15 | | | | | | |
| 24V | | I _e A | 6 | N/A | N/A | N/A |
| 230V/240V | | I _e A | 6 | N/A | N/A | N/A |
| 400V/415V | | I _e A | 4 | N/A | N/A | N/A |
| DC-13 | | | | | | |
| 24V | | I _e A | 3 | 0.2 | N/A | N/A |
| 110V | | I _e A | 0.8 | N/A | N/A | N/A |
| 220V | | I _e A | 0.3 | N/A | N/A | N/A |

Note

① The following applies for LSE-11 and LSE-02: ensure that the power supply operates correctly when setting the operating point.

LS-Titan Miniature DIN Switches—IP66, IP67 Complete Units. continued

| | Units | LS, LSM | LSE-11/LSE-02 | LSE-AI ① | LSE-AU ① |
|--|---------|-------------------|--|----------------------|----------------------|
| Burden Current | | | | | |
| Analog output Q1 | | | | | |
| Output voltage (max. 10 mA) | Vdc | N/A | N/A | | 0–10 |
| Output current | mA | N/A | N/A | 4–20 | |
| Fault scenario | V | N/A | N/A | 0 | 0 |
| Resolution | Steps | N/A | N/A | 100 | 100 |
| Step tolerance | Steps | N/A | N/A | 1 | 1 |
| Shunt resistor, resistive load | ohms | N/A | N/A | <400 | >1000 |
| Digital diagnostics output Q2 (switching to + pole PNP) | | | | | |
| Response threshold | V | N/A | N/A | Approx. U_{θ} | Approx. U_{θ} |
| | mA | N/A | N/A | <200 | <200 |
| Control circuit reliability | | | | | |
| At 24 Vdc/5 mA | H_F | Fault probability | $<10^{-7}$, <1 fault in 10^7 operations | N/A | N/A |
| At 5 Vdc/1 mA | H_F | Fault probability | $<10^{-6}$, <1 failure at 5×10^6 operations | N/A | N/A |
| Supply frequency | Hz | Max. 400 | N/A | N/A | N/A |
| Short-circuit rating to IEC/EN 60947-5-1 | | | | | |
| Maximum fuse | A gG/gL | 6 | N/A | N/A | N/A |
| Repetition accuracy | mm | ± 0.02 | ± 0.02 | ± 0.02 | ± 0.02 |

Note

① The following applies for LSE-11 and LSE-02: ensure that the power supply operates correctly when setting the operating point.

LS-Titan Miniature DIN Switches—IP66, IP67 Complete Units

| | Units | LS, LSM | LSE-11/LSE-02 | LSE-AI/LSE-AU | LSE-AI/LSE-AU |
|--|---|---------------------|------------------------------|---------------|---------------|
| Mechanical Variables | | | | | |
| Lifespan | | | | | |
| Standard-action contact | Operations | X 10 ⁶ 8 | N/A | N/A | N/A |
| Snap-action contact | Operations | X 10 ⁶ 8 | 3 (electronic) | N/A | N/A |
| Contact temperature of roller head | °C | ≤100 | ≤100 | ≤100 | ≤100 |
| Mechanical shock resistance (half-sinusoidal shock, 20 ms) | | | | | |
| Standard-action contact | g | 25 | N/A | N/A | N/A |
| Snap-action contact | g | N/A | N/A | N/A | N/A |
| Basic unit | g | N/A | 30 | 30 | 30 |
| Operating frequency | Operations/h | ≤6000 | ≤3000 | ≤3000 | ≤3000 |
| Switching point | | N/A | 0.5–5.5 mm freely adjustable | N/A | N/A |
| Hysteresis | mm | N/A | 0.4 | 0.4 | 0.4 |
| Contact sequence (contact closed open Zw = positive opening clearance) | mm | N/A | 0.04 | 0.06 | 0.06 |
| Actuation | | | | | |
| Mechanical | | | | | |
| Actuating force at beginning/end of stroke | | | | | |
| Basic units | N | 1.0/8.0 | 3.5/8.0 | 3.5/8.0 | 3.5/8.0 |
| LS(M)-XP | N | 1.0/8.0 | 1.0/8.0 | 1.0/8.0 | 1.0/8.0 |
| LS(M)-XL | N | 1.0/8.0 | 1.0/8.0 | 1.0/8.0 | 1.0/8.0 |
| LS(M)-XLA | N | 1.0/8.0 | 1.0/8.0 | 1.0/8.0 | 1.0/8.0 |
| Actuating torque of rotary drives | Nm | 0.2 | 0.2 | 0.2 | 0.2 |
| Maximum operating speed with DIN cam | | | | | |
| Basic units for angle of actuation | $\alpha = 0^\circ/30^\circ$ | m/s | 1/0.5 | 1/0.5 | 1/0.5 |
| LS(M)-XRL for angle of actuation | $\alpha = 0^\circ$ | m/s | 1.5 | 1.5 | 1.5 |
| LS(M)-XRLA for angle of actuation | $\alpha = 30^\circ, L = 125 \text{ mm}$ | m/s | 1.5 | 1.5 | 1.5 |
| LS(M)-XRR for angle of actuation | $L = 130 \text{ mm}$ | m/s | 1.5 | 1.5 | 1.5 |
| LS(M)-XL for angle of actuation | $\alpha = 30^\circ/45^\circ$ | m/s | 1 | 1 | 1 |
| LS(M)-XLA for angle of actuation | $\alpha = 30^\circ/45^\circ$ | m/s | 1 | 1 | 1 |
| LS(M)-XP for angle of actuation | $\alpha = 0^\circ/30^\circ$ | m/s | 1/1 | 1/1 | 1/1 |
| Electromagnetic Compatibility (EMC) | | | | | |
| Electrostatic discharge (IEC/EN 61000-4-2, Level 3 ESD) | | | | | |
| Air discharge | kV | | 8 | 8 | 8 |
| Contact discharge | kV | | 4 | 4 | 4 |
| Electromagnetic fields (IEC/EN 61000-403, RFI) | V/m | | 10 | 10 | 10 |
| Burst pulses (IEC/EN 61000-4-4, Level 3) | | | | | |
| Supply cables | kV | | 2 | 2 | 2 |
| Signal lines | kV | | 2 | 2 | 2 |
| High-energy pulses (surge) (IEC/EN 61000-4-5) | kV | | 0.5 | 0.5 | 0.5 |
| Immunity to line-conducted interference to (IEC/EN 610000-4-6) | V | | 10 | 10 | 10 |

Contact Travel Diagrams

LSE

Contact Travel

■ = contact closed
□ = contact open

LSE-11

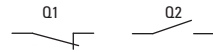

LSE-02

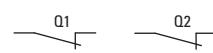

Description

Basic Units

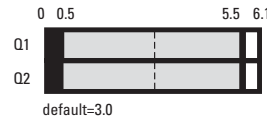
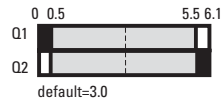

Operating Heads

Roller plunger

- LS-XP
- LSM-XP

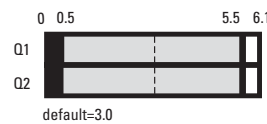
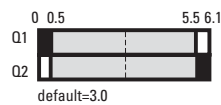

Roller lever

- LS-XL
- LSM-XL
- LS-XL
- LS-XLB

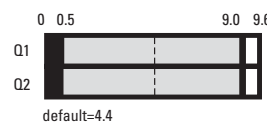
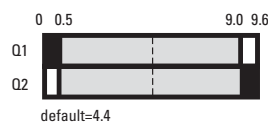

Angled roller lever

- LS-XLA
- LSM-XLA

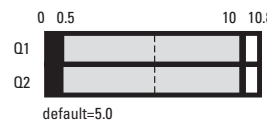
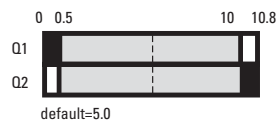

Rotary lever

- LS-XRL
- LSM-XRL

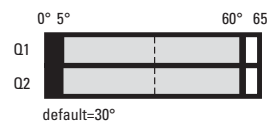
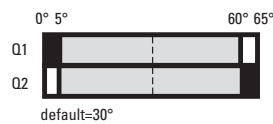

Adjustable roller lever

- LS-XRLA
- LSM-XRLA
- LS-XRLA30
- LS-XRLA40
- LS-XRLA40R

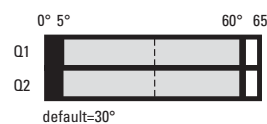
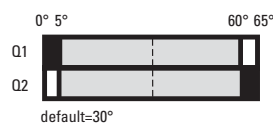

Actuating rod

- LS-XRR
- LSM-XRR
- LS-XRRM
- LSM-XRRM

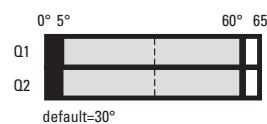
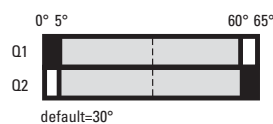

Spring rod

- LS-XS
- LSM-XS

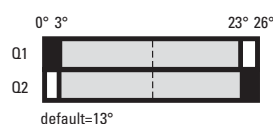

2.3

Limit Switches

LS-Titan Miniature DIN Switches

LS and LSM

2

Contact Travel

■ = contact closed
□ = contact open

LS-02, LS-S02, LSM-02

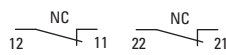

LS-11S, LS-S11S, LSM-11S

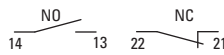

LS-20A, LS-S20A, LSM-20A

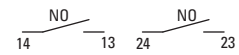

Description

Basic Units

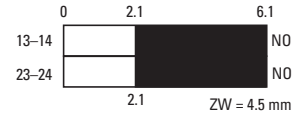
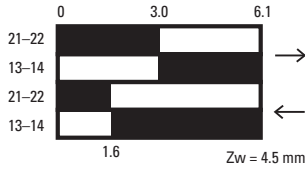
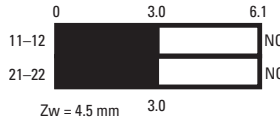

Operating Heads

Roller plunger

LS-XP, LSM-XP

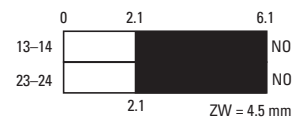
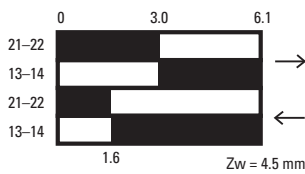
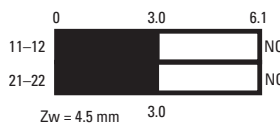

Roller lever

LS-XL, LSM-XL

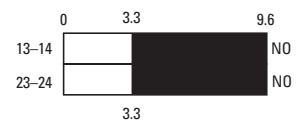
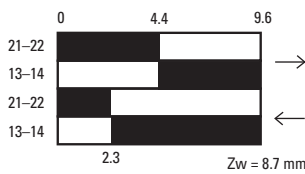
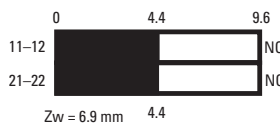

Roller lever, short

LS-XLS

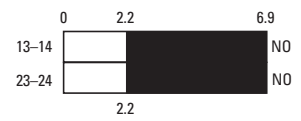
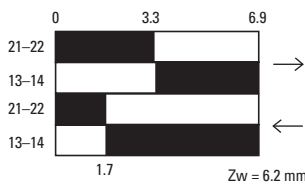
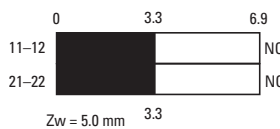

Roller lever, large

LS-XLB

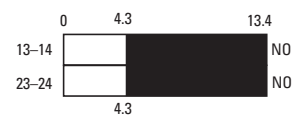
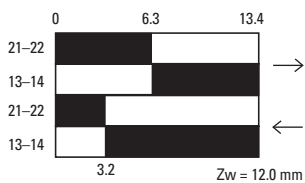
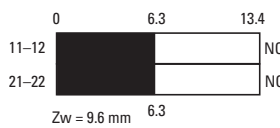

LS and LSM, continued

| | Contact Travel | LS-02, LS-S02, LSM-02 | LS-11S, LS-S11S, LSM-11S | LS-20A, LS-S20A, LSM-20A |
|---|--|-----------------------|--------------------------|--------------------------|
| Description | ■ = contact closed □ = contact open | | | |
| Operating Heads | | | | |
| Angled roller lever | | | | |
| LS-XLA, LSM-XLA | | | | |
| Rotary lever | | | | |
| LS-XRL, LSM-XRL | | | | |
| Adjustable roller lever | | | | |
| LS-XRLA, LSM-XRLA LS-XRLA30, LS-XRLA40 LS-XRLA40R | | | | |
| Actuating rod | | | | |
| LS-XRR, LSM-XRR LS-XRRM, LSM-XRRM | | | | |
| Spring rod | | | | |
| LS-XS, LSM-XS | | | | |

2.3

Limit Switches

LS-Titan Miniature DIN Switches

Dimensions

Approximate Dimensions in Inches (mm)

2

Position Switches

LS-_, LSM-_, LSE-_

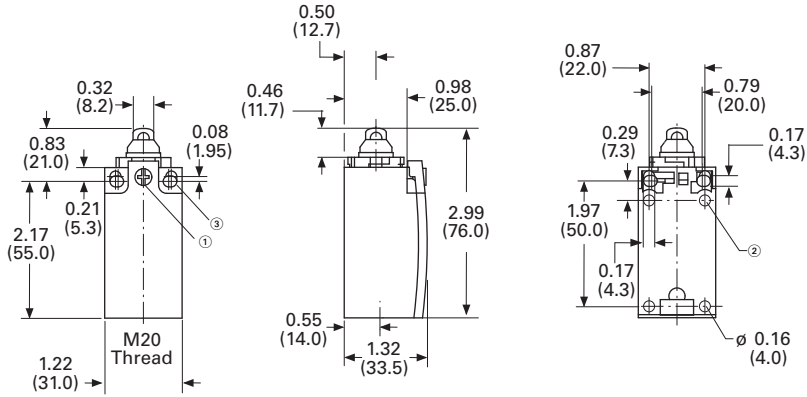

LS-_, LSM-_, LSE-_

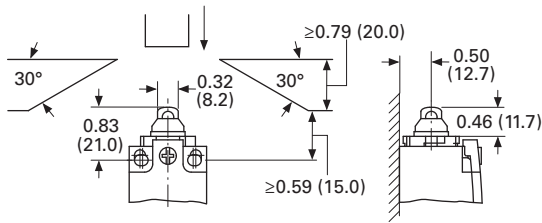

LS(M)-_/S

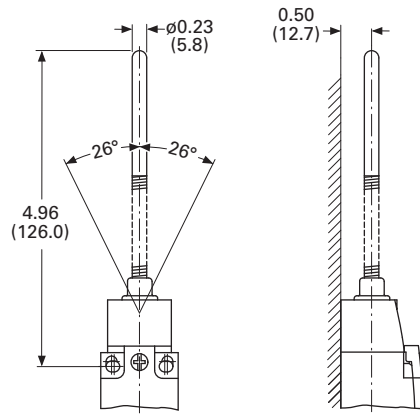

LS(M)-_/P

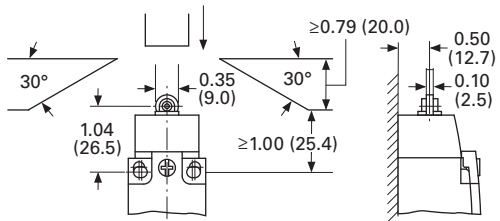

Notes

- ① Tightening torque of cover screws: 0.8 Nm \pm 0.2 Nm.
- ② Only with LS (insulated version).
- ③ Fixing screws 2 x M4 \geq 30
M_A = 1.5 Nm

Approximate Dimensions in Inches (mm)

Rotary Lever

LS(M)-_RL

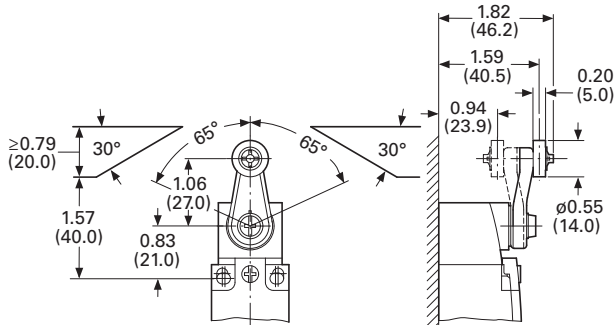

Roller Lever, Short

LS(M)-_LS

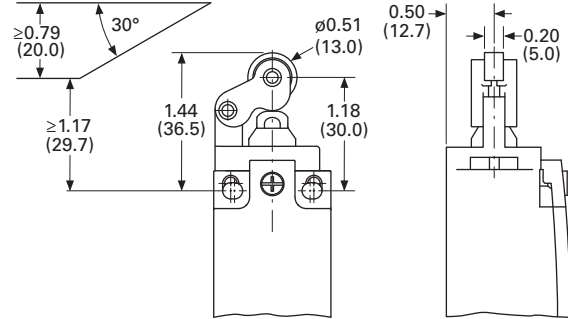

Roller Lever

LS(M)-_L

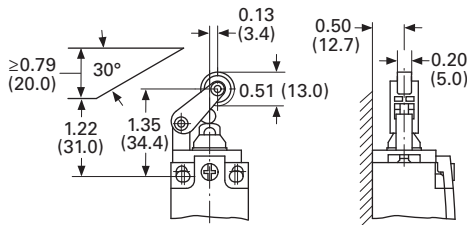

Adjustable Roller Lever

LS(M)-_RLA

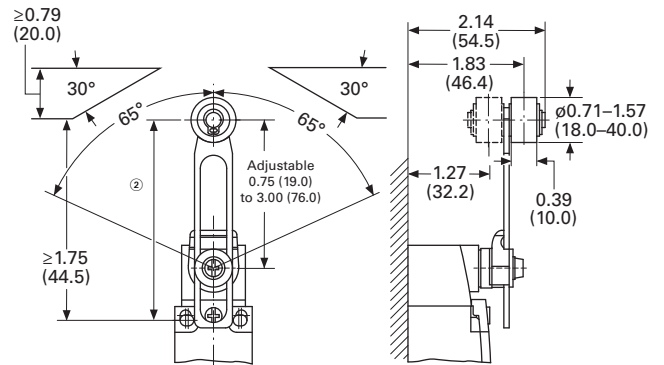

Roller Lever, Large

LS(M)-_LB ①

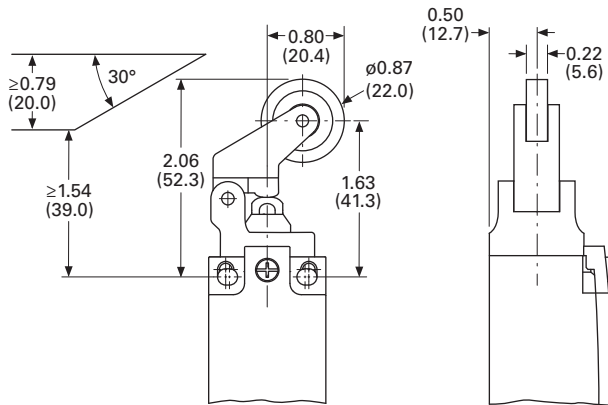

Angled Roller Lever

LS(M)-_XLA

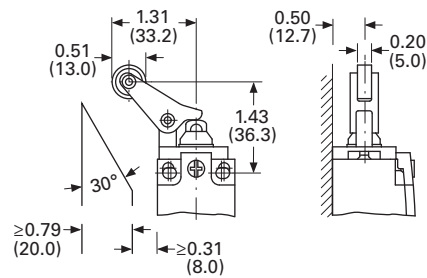

Notes

- ① Tightening torque of cover screws: 0.8 Nm \pm 0.2 Nm.
- ② Setting range of 54.5 to 97.

2.3

Limit Switches

LS-Titan Miniature DIN Switches

Approximate Dimensions in Inches (mm)

2

Actuating Rod

LS(M)-_/RR

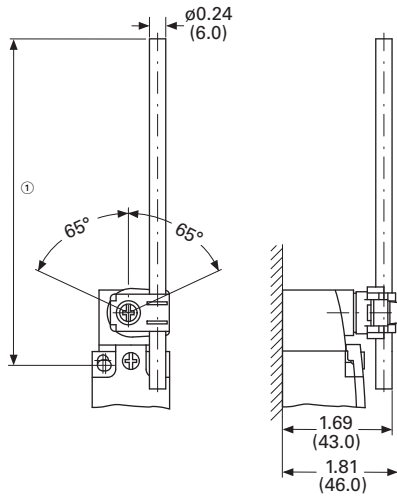

LS(M)-_/OR

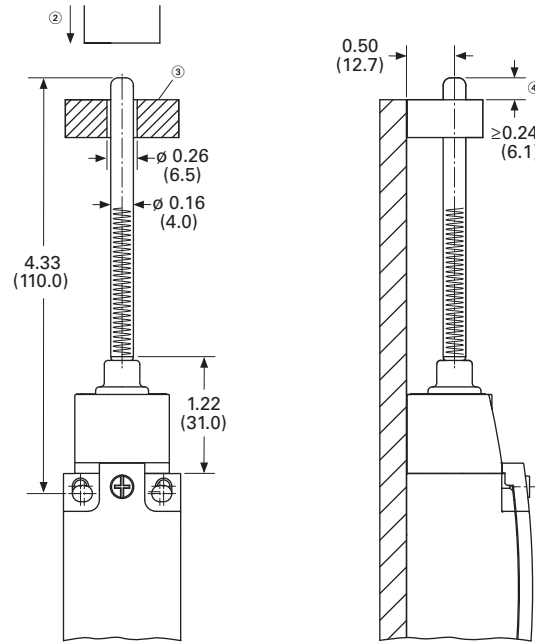

Notes

- ① LS_/RR ≤150
LS_/RRM ≤210
- ② Approach direction, vertical.
- ③ Guide is done by customer, not included.
- ④ Maximum push-through.

E49 Mini Metal Switches



Contents

Description

Page

| | |
|-----------------------------------|----------|
| E49 Mini Metal Switches | |
| Product Selection | V8-T2-44 |
| Technical Data and Specifications | V8-T2-46 |
| Dimensions | V8-T2-47 |



Drawings
Online

E49 Mini Metal Switches

Product Description

E49 Mini Metal Limit Switches from Eaton’s electrical sector are designed small and tough, with machinery OEMs in mind. The small size, metal body and mechanical life make this product perfect for switching applications in packaging, material handling, elevators and lifts, electronic assembly equipment, injection molding machinery, and auto-vending machines. The E49 Mini Metal is the ideal switch for those who need a cost-effective, compact solution, but don’t want to sacrifice durability in the process.

Features

- Long life—rated for 10 million operations
- Pre-wired units with custom cable lengths available for high volume customers
- “Fingerproof” terminals protect against accidental shock
- Double-spring mechanism for contact reliability
- Grounding terminal included
- Captive screws on enclosure cover make wiring hassle-free
- SPDT double break

Standards and Certifications

- UL Recognized
- CE
- RoHS



⚠ DANGER

THIS SENSOR IS NOT A SAFETY DEVICE AND IS NOT INTENDED TO BE USED AS A SAFETY DEVICE. This sensor is designed only to detect and read certain data in an electronic manner and perform no use apart from that, specifically no safety-related use. This sensor product does not include self-checking redundant circuitry, and the failure of this sensor product could cause either an energized or de-energized output condition, which could result in death, serious bodily injury, or property damage.

For the most current information on this product, visit our Web site: www.eaton.com

For Customer Service in the U.S. call 1-877-ETN CARE (386-2273), in Canada call 1-800-268-3578. For Application Assistance in the U.S. and Canada call 1-800-426-9184.

Product Selection

2

E49 Mini Metal Switches

| <i>Operating Head Type</i> | Travel to Operate Contacts | Travel to Reset Contacts | Total Travel | Force to Operate Contacts | Minimum Return Force | Assembled Unit (Switch Body and Head) 1NO-1NC Contacts Catalog Number |
|--|--|---------------------------------|---------------------|----------------------------------|-----------------------------|--|
| Side Rotary Lever  | Side Rotary Lever 20° | 12° | 70° | 750g | 100g | E49G31AP3 |
| Adjustable Side Rotary Lever  | Adjustable Side Rotary Lever 20° | 12° | 70° | 750g | 100g | E49G31UP3 |
| Top Pushbutton  | Top Pushbutton 0.06 in (1.5 mm) | 0.04 in (1 mm) | 0.22 in (5.5 mm) | 900g | 150g | E49G31BP3 |
| Top Push Roller  | Top Push Roller 0.06 in (1.5 mm) | 0.04 in (1 mm) | 0.22 in (5.5 mm) | 900g | 150g | E49G31CP3 |
| Top Push Roller (90° Roller)  | Top Push Roller (90° Roller) 0.06 in (1.5 mm) | 0.04 in (1 mm) | 0.22 in (5.5 mm) | 900g | 150g | E49G31CP3 |
| Adjustable Rod Lever  | Adjustable Rod Lever 20° | 12° | 70° | 750g | 100g | E49G31DP3 |

E49 Mini Metal Switches, continued

| <i>Operating Head Type</i> | Travel to Operate Contacts | Travel to Reset Contacts | Total Travel | Force to Operate Contacts | Assembled Unit (Switch Body and Head) 1NO-1NC Contacts Catalog Number |
|--|-----------------------------------|---------------------------------|---------------------|----------------------------------|--|
| Wobble Stick (Nylon Coil)  | Wobble Stick (Nylon Coil) | | | | |
| | 1.18 in (30 mm) | — | — | 150g | E49G31NP3 |
| Wobble Stick (Metal Coil)  | Wobble Stick (Metal Coil) | | | | |
| | 1.18 in (30 mm) | — | — | 150g | E49G31VP3 |
| Wobble Stick (Metal Rod)  | Wobble Stick (Metal Rod) | | | | |
| | 1.18 in (30 mm) | — | — | 150g | E49G31MP3 |
| Wobble Stick (Whisker)  | Wobble Stick (Whisker) | | | | |
| | 1.18 in (30 mm) | — | — | 150g | E49G31XM3 |

Technical Data and Specifications

2

E49 Mini Metal Switches

| Description | Specification |
|-------------------------------|---|
| Operating speed | 0.19 in (5 mm) to 19.7 in/s (50 cm/s) |
| Operating frequency | 120 operations/min |
| Contact resistance | 25M ohms (initial) |
| Insulation resistance | 100M ohms min (at 500 Vdc) |
| Dielectric strength | 1000 Vac, 50/60 Hz for one minute between non-continuous terminals |
| | 1500 Vac, 50/60 Hz for one minute between current-carrying and non-current-carrying parts and between each terminal and ground |
| Vibration | 10 to 55 Hz, 1.5 mm double amplitude |
| Shock | Approx. 300 m/s ² (approx. 30Gs) |
| Ambient operating temperature | 23° to 149°F (–5° to 65°C) |
| Humidity | 95% RH max. |
| Service life | Mechanical: 10,000,000 operations min. |
| | Electrical: 500,000 operations min. |
| Weight | Approx. 130 to 190g |
| Degree of protection | IEC: IP65 |
| Material of construction | Shaft: stainless SUS303 Arm: stainless SUS304 Head and body: zinc alloy Terminal cover: PC/ABS plastic Rubber grommet: NBR rubber |

Maximum Ampere Ratings

| Rated Voltage | Non-Inductive Load (A) | | Lamp Load ^② | | Inductive Load (A) ^① | | Motor Load | |
|---------------|------------------------|-----|------------------------|-----|---------------------------------|----|------------|-----|
| | Resistive Load | | NC | NO | Inductive Load | | NC | NO |
| | NC | NO | | | NC | NO | | |
| 125 Vac | 5 | 5 | 1.5 | 0.7 | 3 | 3 | 2 | 1 |
| 250 Vac | 5 | 5 | 1 | 0.5 | 3 | 3 | 1.5 | 0.8 |
| 8 Vdc | 5 | 5 | 3 | 3 | 5 | 4 | 3 | 3 |
| 14 Vdc | 5 | 5 | 3 | 3 | 4 | 4 | 3 | 3 |
| 30 Vdc | 5 | 5 | 3 | 3 | 4 | 4 | 3 | 3 |
| 125 Vdc | 0.4 | 0.4 | — | — | — | — | — | — |
| 250 Vdc | 0.2 | 0.2 | — | — | — | — | — | — |

Terminal Configuration

NO (4) —○ ○— NO (3)

NC (1) —● ●— NC (2)

Notes

- ^① Inductive load has a power factor of 0.4 min. (AC) and a time constant of 7 msec. max. (DC).
^② Lamp load has an inrush current of ten times the steady-state current, while motor load has an inrush current of six times the steady-state current.

Dimensions

Approximate Dimensions in Inches (mm)

E49G31AP3

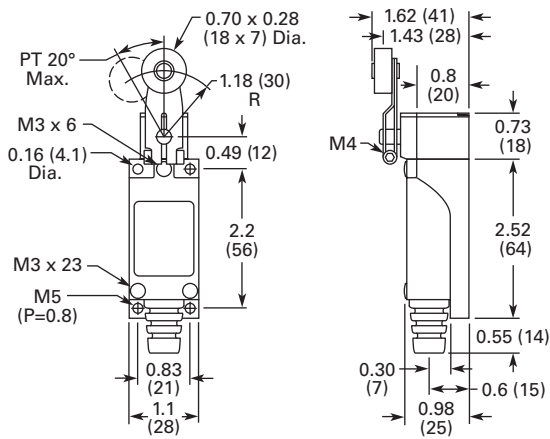

E49G31CP3

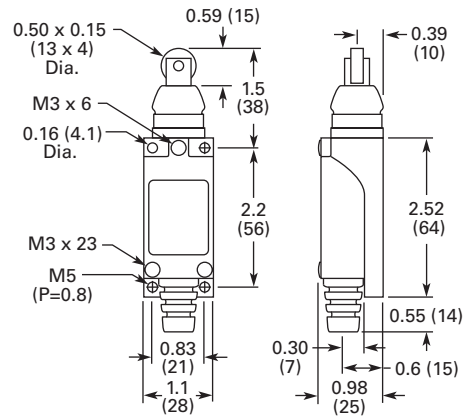

E49G31BP3

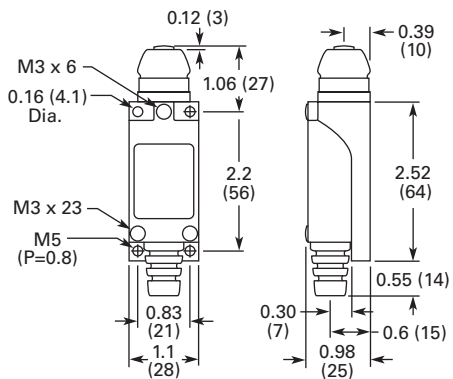

E49G31DP3

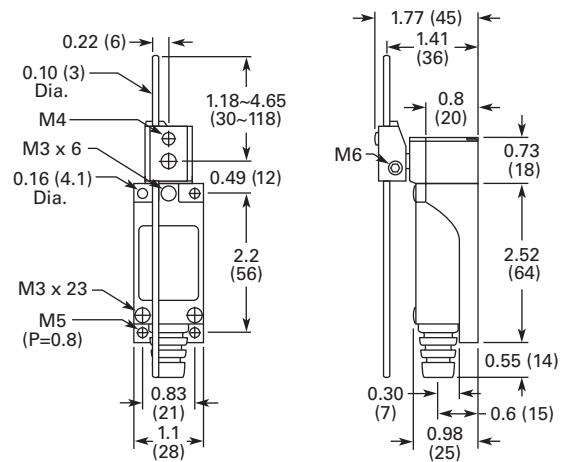

E49G31C1P3

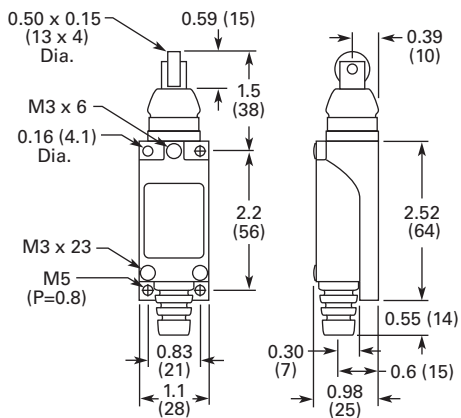

E49G31MP3

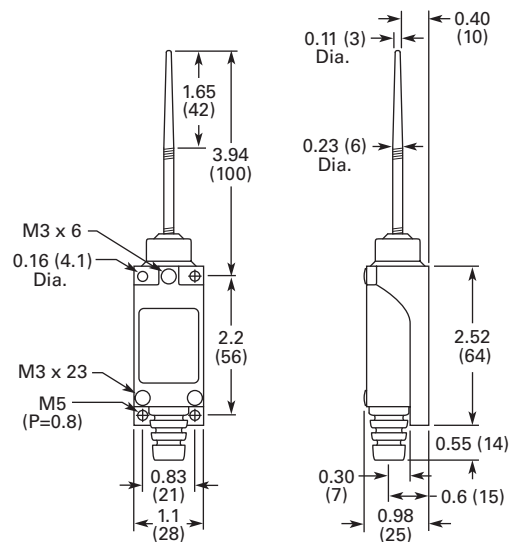

2.4

Limit Switches

E49 Mini Metal Switches

Approximate Dimensions in Inches (mm)

E49G31NP3

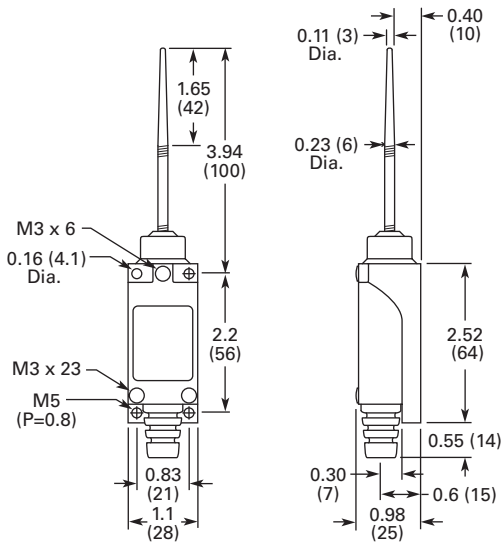

E49G31VP3

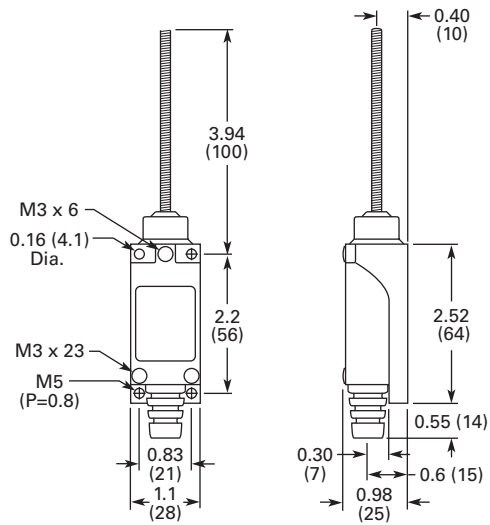

E49G31UP3

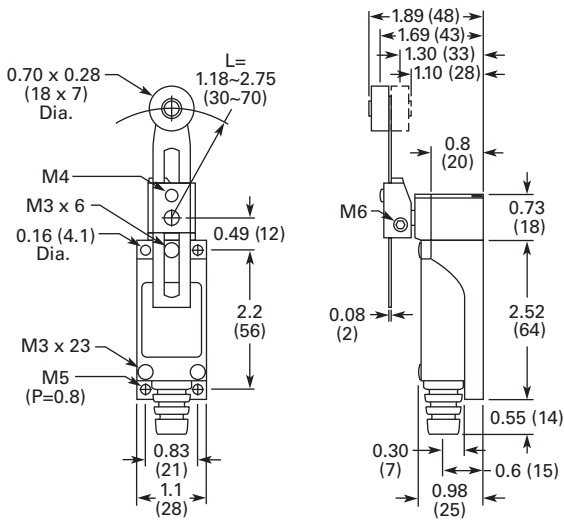

E49G31XM3

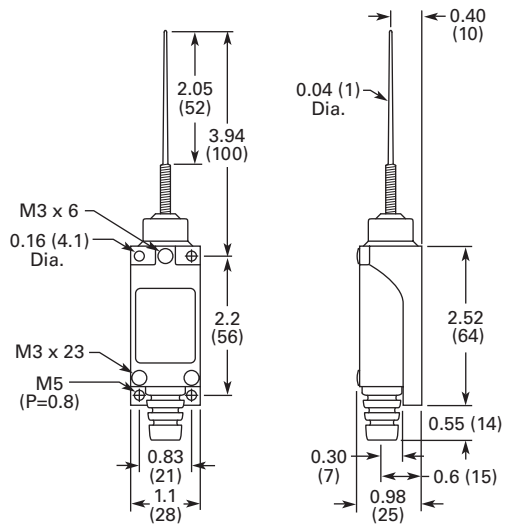

E49 Compact Metal Switches



Contents

Description

Page

| | |
|-----------------------------------|----------|
| E49 Compact Metal Switches | |
| Product Selection | V8-T2-50 |
| Technical Data and Specifications | V8-T2-52 |
| Dimensions | V8-T2-53 |



Drawings
Online

E49 Compact Metal Switches

Product Description

E49 Compact Metal Switches by Eaton’s electrical sector are designed with high mechanical strength for robust environments. The rugged aluminum die cast construction provides reliable, oil-tight, waterproof and dustproof sealing for a variety of applications. Snap action 1NO-1NC contacts provide flexibility in design.

Features

- Rigid die cast switch housing
- High mechanical strength
- Oil-tight, waterproof and dustproof construction

Standards and Certifications

- cULus
- NEMA A600 (AC-15)
- NEMA R300 (DC-13)
- IP67
- RoHS



⚠ DANGER

THIS SENSOR IS NOT A SAFETY DEVICE AND IS NOT INTENDED TO BE USED AS A SAFETY DEVICE. This sensor is designed only to detect and read certain data in an electronic manner and perform no use apart from that, specifically no safety-related use. This sensor product does not include self-checking redundant circuitry, and the failure of this sensor product could cause either an energized or de-energized output condition, which could result in death, serious bodily injury, or property damage.

For the most current information on this product, visit our Web site: www.eaton.com

For Customer Service in the U.S. call 1-877-ETN CARE (386-2273), in Canada call 1-800-268-3578. For Application Assistance in the U.S. and Canada call 1-800-426-9184.



Product Selection

2

E49 Compact Metal Switches

| <i>Operating Head Type</i> | Travel to Operate Contacts | Travel to Reset Contacts | Total Travel | Force to Operate Contacts (Maximum) | Minimum Return Force | Assembled Unit (Switch Body and Head) 1NO-1NC Contacts Catalog Number |
|---|-----------------------------------|---------------------------------|---------------------|--|-----------------------------|--|
| Roller Lever | | | | | | |
|  | 20° | 12° | 50° | 2.99 lbs | 0.50 lb | E49M11AP1 |
| Top Push | | | | | | |
|  | 0.067 in (1.7 mm) | 0.04 in (1.0 mm) | — | 6.02 lbs | 2.01 lbs | E49M11BP1 |
| Top Push Roller | | | | | | |
|  | 0.067 in (1.7 mm) | 0.04 in (1.0 mm) | 0.25 in (6.5 mm) | 6.02 lbs | 2.01 lbs | E49M11CP1 (as pictured) |
| | | | | | | E49M11CP2 90° Cross Roller |
| Rod Lever | | | | | | |
|  | 20° | 12° | 50° | 0.31 lb | 0.06 lb | E49M11DP1 |

E49 Compact Metal Switches, continued

| <i>Operating Head Type</i> | Travel to Operate Contacts | Travel to Reset Contacts | Total Travel | Force to Operate Contacts (Maximum) | Minimum Return Force | Assembled Unit (Switch Body and Head) 1NO-1NC Contacts Catalog Number |
|---|-----------------------------------|---------------------------------|---------------------|--|-----------------------------|--|
| Adjustable Roller Lever  | Adjustable Roller Lever | | | | | |
| | 20° | 12° | 50° | 2.99 lbs | 0.50 lb | E49M11UP1 |
| Wobble  | Wobble | | | | | |
| | 1.10 in (28 mm) | N/A | N/A | 0.33 lb | N/A | E49M11VP1 |
| Cat Whisker  | Cat Whisker | | | | | |
| | 1.10 in (28 mm) | N/A | N/A | 0.064 lb | N/A | E49M11XM1 |

Technical Data and Specifications

2

E49 Compact Metal Switches

| Description | Specification |
|-------------------------------|---|
| Operating speed | 1 mm to 2m/sec |
| Operating frequency | Mechanically: 120 operations/min.; Electronically: 30 operations/min. |
| Contact resistance | 15M ohms max. (initial) |
| Insulation resistance | 100M ohms min. (at 500 Vdc) |
| Dielectric strength | 1000 Vac, 50/60 Hz for 1 minute between non-continuous terminals; 2200 Vac, 50/60 Hz for 1 minute between each terminal and non-current carrying metal part and between each terminal and ground |
| Vibration | Malfunction durability: approx. 1000 m/sec ² (approx. 100 Gs); Malfunction durability: approx. 300/sec ² (30 Gs) |
| Ambient operating temperature | 14° to 176°F (–10° to 80°C) |
| Humidity | 95% RH max. |
| Service life | Mechanically: 15,000,000 operations/minute; Electronically: 500,000 operations/minute |

Maximum Ampere Ratings—Isolated Contacts, No Polarity Restriction

NEMA A600 (AC-15) 50 or 60 Hz

| Rated Voltage | Current | | | Voltamperes | | NEMA R300 (DC-13) | |
|---------------|------------|------|-------|-------------|--------|-------------------|---------|
| | Continuous | Make | Break | Make | Break | Rated Voltage | Current |
| 24 Vac | 10A | 60A | 6.0A | 7200 VA | 720 VA | 24 Vdc | 1.5A |
| 120 Vac | 10A | 60A | 6.0A | 7200 VA | 720 VA | 120 Vdc | 0.22A |
| 250 Vac | 10A | 30A | 3.0A | 7200 VA | 720 VA | 250 Vdc | 0.11A |
| 480 Vac | 10A | 15A | 1.5A | 7200 VA | 720 VA | | |
| 600 Vac | 10A | 12A | 1.2A | 7200 VA | 720 VA | | |

Dimensions

Approximate Dimensions in Inches (mm)

Switch Body with E49M11BP1

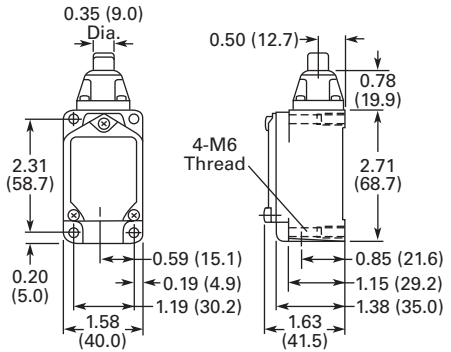

E49M11UP1

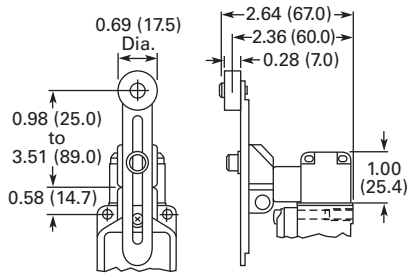

E49M11CP1/E49M11CP2

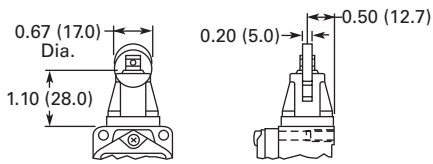

E49M11VP1

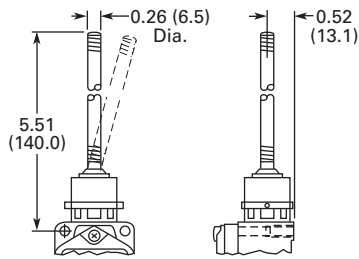

E49M11DP1

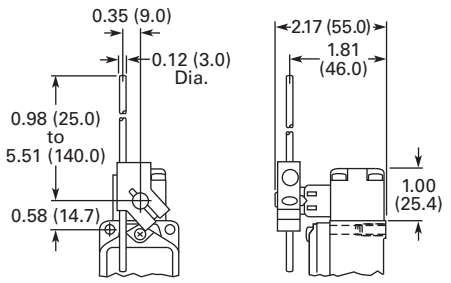

E49M11XM1

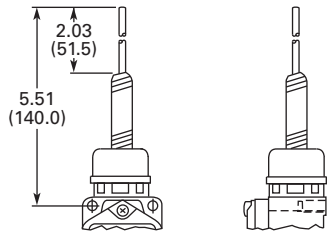

E49M11AP1

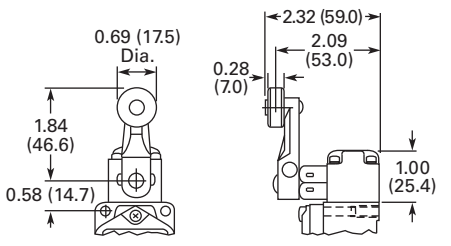

E50 Heavy-Duty Plug-In Switches

2



E50 Heavy-Duty Plug-In Switches

Product Description

E50 Modular Plug-In Limit Switch Components from Eaton's electrical sector are the industry standard with versatility of design and high reliability for low maintenance, installation and inventory costs. Standard Viton gaskets, seals and boots and a zinc die cast enclosure provide exceptional chemical resistance to the common coolants, cleansing agents, and hydraulic fluids found in machine tool, automotive, waste water treatment and other heavy-duty industrial applications. Mounting dimensions accommodate both U.S. and DIN standards for easy retrofit installations. Super bright 24–120 Vac/dc LED indicating light versions simplify setup and troubleshooting operations.

Features

- Modular, plug-in components (head, body and receptacle) provide application flexibility, reduced inventory and less downtime
- Manufactured to take the physical and environmental abuse (including cutting fluids and chemicals) of harsh industrial environments
- Chemical resistant Viton gaskets, seals and boots are standard, and so are captive, posi-drive screws
- The switches have terminal identification on the nameplate for a visual wiring checkout without guesswork. Heads and switch bodies can be replaced without rewiring

Contents

Description

| | <i>Page</i> |
|--|-----------------|
| E50 Heavy-Duty Plug-In Switches | |
| Product Selection | |
| Assembled Switches—Standard | V8-T2-55 |
| Assembled Switches—Special Purpose | V8-T2-58 |
| Operating Heads | V8-T2-59 |
| Switch Bodies | V8-T2-60 |
| Receptacles | V8-T2-61 |
| Compatible Connector Cables | V8-T2-62 |
| Accessories | V8-T2-62 |
| Technical Data and Specifications | V8-T2-64 |
| Circuit Diagrams | V8-T2-65 |
| Wiring Diagrams | V8-T2-65 |
| Dimensions | V8-T2-66 |



Drawings
Online

Standards and Certifications

- UL Listed
- CSA Certified
- IEC.9475.1
- TUV—E9271605E02
- CE (where shown)



⚠ DANGER

THIS SENSOR IS NOT A SAFETY DEVICE AND IS NOT INTENDED TO BE USED AS A SAFETY DEVICE. This sensor is designed only to detect and read certain data in an electronic manner and perform no use apart from that, specifically no safety-related use. This sensor product does not include self-checking redundant circuitry, and the failure of this sensor product could cause either an energized or de-energized output condition, which could result in death, serious bodily injury, or property damage.

For the most current information on this product, visit our Web site: www.eaton.com

For Customer Service in the U.S. call 1-877-ETN CARE (386-2273), in Canada call 1-800-268-3578. For Application Assistance in the U.S. and Canada call 1-800-426-9184.

Product Selection

Assembled Switches—Standard

Assembled Switch E50 Heavy-Duty Plug-In Switches, Assembled—Standard

Assembled Switch



Single-Pole (5 Terminal Receptacle)



Two-Pole (9 Terminal Receptacle)

| Indicating Light: | None | LED (24–120 Vac/dc) | Neon (120 Vac) | None | LED (24–120 Vac/dc) | Neon (120 Vac) | LED (24–120 Vac/dc) | Neon (120 Vac) |
|------------------------------|---|------------------------|-------------------|---|------------------------|-------------------|------------------------|-------------------|
| | Switch Body: | E50SA 1NO-1NC | E50SAL 1NO-1NC | | E50SAN 1NO-1NC | E50SB 2NO-2NC | E50SBL 2NO-2NC | E50SBN 2NO-2NC |
| Receptacle: ① | E50RA | E50RA | E50RA | E50RB | E50RB | E50RB | E50RB | E50RB |
| Operating Head Type ② | Description | | | Description | | | | |
| | Assembled Switch (Head + Receptacle + Body) Catalog Number | | | Assembled Switch (Head + Receptacle + Body) Catalog Number | | | | |

Operating Head Type ②

Side Rotary



Side Rotary (requires an operating lever, see Page V8-T2-80)

| | | | |
|----------------------------------|--------|---------|---------|
| Standard spring return—E50DR1 ③ | E50AR1 | E50ALR1 | E50ANR1 |
| Low force spring return—E50DL1 ③ | E50AL1 | E50ALL1 | E50ANL1 |
| Maintained two-position—E50DM1 | E50AM1 | E50ALM1 | E50ANM1 |

| | | | | |
|--------|---------|---------|---|---|
| E50BR1 | E50BLR1 | E50BNR1 | — | — |
| E50BL1 | E50BLL1 | E50BNL1 | — | — |
| E50BM1 | E50BLM1 | E50BNM1 | — | — |

Spring Return



| | | | |
|----------------------|--------|---------|---------|
| Spring return—E50DS1 | E50AS1 | E50ALS1 | E50ANS1 |
|----------------------|--------|---------|---------|

| | | | | |
|--------|---------|---------|---------|---|
| E50BS1 | E50BSL1 | E50BNS1 | E50CLS1 | — |
|--------|---------|---------|---------|---|

Adjustable Spring Return



| | | | |
|---------------------------------|--------|---------|---------|
| Adjustable spring return—E50DS2 | E50AS2 | E50ALS2 | E50ANS2 |
|---------------------------------|--------|---------|---------|

| | | | | |
|--------|---------|---------|---------|---------|
| E50BS2 | E50BSL2 | E50BNS2 | E50BLS2 | E50CNS2 |
|--------|---------|---------|---------|---------|

Circuit Diagrams, see Page V8-T2-65.

Notes

① Connection options (add the code suffix from the table below to the end of the catalog number):

| Option | | Mating Cordset Catalog Number | Code Suffix | |
|--|---|----------------------------------|-------------|-----|
| Mini-connector ④ (with epoxy filled receptacle) | Single-pole (5-pin mini-connector) | CSMS5D5CY1602 | P5 ⑤ | |
| | Two-pole (9-pin mini-connector) | CSMS9D9CY1602 | P9 ⑤ | |
| Micro-connector ④ (with epoxy filled receptacle) | Single-pole (5-pin micro-connector) | CSDS5A5CY2202 | A5 ⑤ | |
| | Cable connection (with epoxy filled receptacle) | 8 ft cable length | — | S |
| | | 12 ft cable length | — | S12 |
| 20 ft cable length | | — | S20 | |
| Manifold mount (rear wiring entrance) | — | — | M | |
| 20 mm conduit entrance | — | — | 20 | |

② For operating head specifications, see Page V8-T2-59.

③ CW (clockwise) and CCW (counterclockwise) operation, easily convertible to CW only or CCW only operation.

④ For a full selection of cable connectors, see Tab 10, section 10.1.

⑤ Refer to Page V8-T2-65 for wiring diagrams.

2.6

Limit Switches

E50 Heavy-Duty Plug-In Switches

2

Assembled Switch



E50 Heavy-Duty Plug-In Switches, Assembled—Standard, continued



Single-Pole (5 Terminal Receptacle)

Two-Pole (9 Terminal Receptacle)

| Indicating Light: | None | LED (24–120 Vac/dc) | Neon (120 Vac) | None | LED (24–120 Vac/dc) | Neon (120 Vac) | LED (24–120 Vac/dc) | Neon (120 Vac) |
|------------------------------|---|------------------------|-------------------|---|------------------------|-------------------|------------------------|-------------------|
| Switch Body: | E50SA | E50SAL | E50SAN | E50SB | E50SBL | E50SBN | E50SCL | — |
| Receptacle: ① | 1NO-1NC | 1NO-1NC | 1NO-1NC | 2NO-2NC | 2NO-2NC | 2NO-2NC | 1NO-2NC | — |
| | E50RA | E50RA | E50RA | E50RB | E50RB | E50RB | E50RB | E50RB |
| Operating Head Type ② | Assembled Switch (Head + Receptacle + Body) Catalog Number | | | Assembled Switch (Head + Receptacle + Body) Catalog Number | | | | |

Side Push Roller



Side Push Roller

| | | | | | | | | |
|----------------------------|--------------|---------|---------|--------|---------|---------|---------|---|
| Spring return— E50DS3 ③ | E50AS3 CE | E50ALS3 | E50ANS3 | E50BS3 | E50BLS3 | E50BNS3 | E50BLS3 | — |
|----------------------------|--------------|---------|---------|--------|---------|---------|---------|---|

Side Pushbutton



Side Pushbutton

| | | | | | | | | |
|-----------------------|--------------|---------|---------|--------|---------|---------|---------|---|
| Maintained— E50DH1 | E50AH1 CE | E50ALH1 | E50ANH1 | E50BH1 | E50BLH1 | E50BNH1 | E50BLH1 | — |
|-----------------------|--------------|---------|---------|--------|---------|---------|---------|---|

Top Pushbutton

Spring Return



| | | | | | | | | |
|--------------------------|--------------|---------|---------|--------|---------|---------|---------|---------|
| Spring return— E50DT1 | E50AT1 CE | E50ALT1 | E50ANT1 | E50BT1 | E50BLT1 | E50BNT1 | E50CLT1 | E50BNT1 |
|--------------------------|--------------|---------|---------|--------|---------|---------|---------|---------|

Adjustable Spring Return



| | | | | | | | | |
|------------------------------------|--------------|---------|---------|--------|---------|---------|---|---|
| Adjustable spring return—E50DT2 | E50AT2 CE | E50ALT2 | E50ANT2 | E50BT2 | E50BLT2 | E50BNT2 | — | — |
|------------------------------------|--------------|---------|---------|--------|---------|---------|---|---|

Circuit Diagrams, see [Page V8-T2-65](#).

Notes

① Connection options (add the code suffix from the table below to the end of the catalog number):

| Option | | Mating Cordset Catalog Number | Code Suffix |
|--|-------------------------------------|----------------------------------|-------------|
| Mini-connector ④ (with epoxy filled receptacle) | Single-pole (5-pin mini-connector) | CSMS5D5CY1602 | P5 ⑤ |
| | Two-pole (9-pin mini-connector) | CSMS9D9CY1602 | P9 ⑤ |
| Micro-connector ④ (with epoxy filled receptacle) | Single-pole (5-pin micro-connector) | CSDS5A5CY2202 | A5 ⑤ |
| Cable connection (with epoxy filled receptacle) | 8 ft cable length | — | S |
| | 12 ft cable length | — | S12 |
| | 20 ft cable length | — | S20 |
| Manifold mount (rear wiring entrance) | — | — | M |
| 20 mm conduit entrance | — | — | 20 |

② For operating head specifications, see [Page V8-T2-59](#).

③ Roller can be converted in the field between horizontal and vertical.

④ For a full selection of cable connectors, see [Tab 10, section 10.1](#).

⑤ Refer to [Page V8-T2-65](#) for wiring diagrams.

E50 Heavy-Duty Plug-In Switches, Assembled—Standard, continued

Assembled Switch



Single-Pole (5 Terminal Receptacle)

Two-Pole (9 Terminal Receptacle)

| Indicating Light: | None | LED (24–120 Vac/dc) | Neon (120 Vac) | None | LED (24–120 Vac/dc) | Neon (120 Vac) | LED (24–120 Vac/dc) | Neon (120 Vac) |
|-------------------|---|------------------------|-------------------|---|------------------------|-------------------|------------------------|-------------------|
| Switch Body: | E50SA 1NO-1NC | E50SAL 1NO-1NC | E50SAN 1NO-1NC | E50SB 2NO-2NC | E50SBL 2NO-2NC | E50SBN 2NO-2NC | E50SCL 1NO-2NC | — |
| Receptacle: ① | E50RA | E50RA | E50RA | E50RB | E50RB | E50RB | E50RB | E50RB |
| Description | Assembled Switch (Head + Receptacle + Body) Catalog Number | | | Assembled Switch (Head + Receptacle + Body) Catalog Number | | | | |

Operating Head Type ②

Top Push Roller



| Description | Top Push Roller | | | Top Push Roller | | | | |
|---------------------------|-----------------|---------|---------|-----------------|---------|---------|---|---|
| Spring return E50DT3 ③ | E50AT3 CE | E50ALT3 | E50ANT3 | E50BT3 | E50BLT3 | E50BNT3 | — | — |

Wobble Head, Spring Return



| Description | Wobble Head, Spring Return (requires a wobble operator, see Page V8-T2-80) | | | Wobble Head, Spring Return | | | | |
|--|---|---------|---------|----------------------------|---------|---------|----------|---------|
| Standard duty— E50DW1 | E50AW1 CE | E50ALW1 | E50ANW1 | E50BW1 | E50BLW1 | E50BNW1 | EB50BLW1 | — |
| Heavy-duty high strength steel— E50DW2 | E50AW2 CE | E50ALW2 | E50ANW2 | E50BW2 | E50BLW2 | E50BNW2 | E50CLW2 | E50BNW2 |

Circuit Diagrams, see Page V8-T2-65.

Notes

① Connection options (add the code suffix from the table below to the end of the catalog number):

| Option | | Mating Cordset Catalog Number | Code Suffix |
|--|-------------------------------------|----------------------------------|-------------|
| Mini-connector ④ (with epoxy filled receptacle) | Single-pole (5-pin mini-connector) | CSMS5D5CY1602 | P5 ⑤ |
| | Two-pole (9-pin mini-connector) | CSMS9D9CY1602 | P9 ⑤ |
| Micro-connector ④ (with epoxy filled receptacle) | Single-pole (5-pin micro-connector) | CSDS5A5CY2202 | A5 ⑤ |
| Cable connection (with epoxy filled receptacle) | 8 ft cable length | — | S |
| | 12 ft cable length | — | S12 |
| | 20 ft cable length | — | S20 |
| Manifold mount (rear wiring entrance) | — | — | M |
| 20 mm Conduit Entrance | — | — | 20 |

② For operating head specifications, see Page V8-T2-59.

③ Roller can be converted in the field between horizontal and vertical.

④ For a full selection of cable connectors, see Tab 10, section 10.1.

⑤ Refer to Page V8-T2-65 for wiring diagrams.

2.6



Limit Switches

E50 Heavy-Duty Plug-In Switches

Assembled Switches—Special Purpose

2

E50 Heavy-Duty Plug-In Switches, Assembled—Special Purpose

| | Operating Data— Nominal Switches | Assembled Switch Catalog Number | Switch Body Only Catalog Number | Receptacle Only Catalog Number | Operating Head Only Catalog Number |
|--|---|--|--|--|--|
| Neutral Position | Neutral Position (requires an operating lever, see Page V8-T2-80) | | | | |
|  | 5° Travel | E50NN1 ① | E50SN | E50RB | E50DN1 ① |
| | 5° Travel; stainless steel shaft | E50NN1SPL ② | — | — | — |
| | 15° Travel | E50NN2 | E50SN | E50RB | E50DN2 ① |
| | Travel to operate contacts: | 5° or 15° ③ | 5° or 15° ③ | 5° or 15° ③ | 5° or 15° ③ |
| | Travel to reset contacts: | 2° | 2° | 2° | 2° |
| | Total travel: | 90° | 90° | 90° | 90° |
| | Force to operate contacts: | 1.8 in-lbs | 1.8 in-lbs | 1.8 in-lbs | 1.8 in-lbs |
| | Minimum return force: | 2.5 in-oz | 2.5 in-oz | 2.5 in-oz | 2.5 in-oz |
| | Operating temperature: | 14° to 200°F (–10° to 94°C) | 14° to 200°F (–10° to 94°C) | 14° to 200°F (–10° to 94°C) | 14° to 200°F (–10° to 94°C) |
| Two-Step | Two-Step CW, CCW, or both, Convertible (requires an operating lever, see Page V8-T2-80) | | | | |
|  | — | E50TD1 | E50ST | E50RB | E50DD1 |
| | Travel to operate contacts: | 1st step 10°; 2nd step 20° | 1st step 10°; 2nd step 20° | 1st step 10°; 2nd step 20° | 1st step 10°; 2nd step 20° |
| | Travel to reset contacts: | 4° each | 4° each | 4° each | 4° each |
| | Total travel: | 90° | 90° | 90° | 90° |
| | Force to operate contacts: | 3 in-lbs | 3 in-lbs | 3 in-lbs | 3 in-lbs |
| | Minimum return force: | 4.5 in-oz | 4.5 in-oz | 4.5 in-oz | 4.5 in-oz |
| | Operating temperature: | CW or CCW: 14° to 250°F (–10° to 121°C) CW and CCW: 14° to 200°F (–10° to 94°C) | CW or CCW: 14° to 250°F (–10° to 121°C) CW and CCW: 14° to 200°F (–10° to 94°C) | CW or CCW: 14° to 250°F (–10° to 121°C) CW and CCW: 14° to 200°F (–10° to 94°C) | CW or CCW: 14° to 250°F (–10° to 121°C) CW and CCW: 14° to 200°F (–10° to 94°C) |
| Gravity Return | Gravity Return (requires E50KL220, E50KL226 or equivalent operating lever, see Page V8-T2-80) | | | | |
|  | Without indicating light | E50GG1 | E50SG | E50RA | E50DG1 |
| | With LED indicating light (24–120 Vac/dc) | E50GLG1 | E50SGL | E50RA | E50DG1 |
| | With neon indicating light (120 Vac) | E50GNG1 | E50SGN | E50RA | E50DG1 |
| | Travel to operate contacts: | 10° to 170° | 10° to 170° | 10° to 170° | 10° to 170° |
| | Travel to reset contacts: | 8° | 8° | 8° | 8° |
| | Total travel: | 360° | 360° | 360° | 360° |
| | Force to operate contacts: | 3.0 in-oz | 3.0 in-oz | 3.0 in-oz | 3.0 in-oz |
| | Minimum return force: | Gravity | Gravity | Gravity | Gravity |
| | Operating temperature: | 14° to 200°F (–10° to 94°C) | 14° to 200°F (–10° to 94°C) | 14° to 200°F (–10° to 94°C) | 14° to 200°F (–10° to 94°C) |







Circuit Diagrams, see [Page V8-T2-65](#).

Notes

- ① Add **9** suffix to the model number for low temperature –40° to 174°F (–40 to 79°C) versions.
- ② Low temperature rating –40° to 174°F (–40° to 79°C)
- ③ Depending upon model selected.

Operating Heads

E50 Heavy-Duty Plug-In Switches, Operating Heads

| Description | Travel to Operate Contacts | Travel to Reset Contacts | Total Travel | Force to Operate Contacts | Minimum Return Force | Operating Temperature ^① | | Catalog Number |
|---|----------------------------|--------------------------|--------------|---------------------------|----------------------|---|---|----------------------------|
| | | | | | | Without Cable | With Pre-Wired Cable | |
| Side Rotary | | | | | | | | |
| Side Rotary (requires an operating lever, see Page V8-T2-80) | | | | | | | | |
|  Standard spring return ^② | 5° | 2° | 90° | 3 in-lbs | 4.5 in-oz | 10° to 200°F (-12° to 94°C) ^③ | 10° to 200°F (-12° to 94°C) ^③ | E50DR1 |
| Low temperature spring return ^② | 5° | 2° | 90° | 3 in-lbs | 4.5 in-oz | -40° to 175°F (-40° to 79°C) | -31° to 175°F (-34° to 79°C) | E50DR19 |
| Low force spring return ^② | 15° | 6° | 90° | 1.5 in-lbs | 2.5 in-oz | 10° to 200°F (-12° to 94°C) ^③ | 10° to 200°F (-12° to 94°C) ^③ | E50DL1 |
| Maintained two-position | 50° | 50° | 90° | 3 in-lbs | — | 14° to 200°F (-10° to 94°C) | 14° to 200°F (-10° to 94°C) | E50DM1 |
| Side Pushbutton | | | | | | | | |
|  Spring return | 0.065 in | 0.030 in | 0.250 in | 4 lbs | 8 oz | 14° to 200°F (-10° to 94°C) | 14° to 200°F (-10° to 94°C) | E50DS1 |
|  Adjustable Spring Return | 0.065 in | 0.030 in | 0.250 in | 4 lbs | 8 oz | 14° to 200°F (-10° to 94°C) | 14° to 200°F (-10° to 94°C) | E50DS2 |
| Side Push Roller | | | | | | | | |
|  Spring return ^④ | 0.065 in | 0.030 in | 0.250 in | 4 lbs | 8 oz | 14° to 200°F (-10° to 94°C) | 14° to 200°F (-10° to 94°C) | E50DS3 ^⑤ |
| | 0.065 in | 0.030 in | 0.250 in | 4 lbs | 8 oz | 14° to 200°F (-10° to 94°C) | 14° to 200°F (-10° to 94°C) | E50DS4 ^⑤ |
| Side Pushbutton | | | | | | | | |
|  Maintained | 0.200 in | 0.130 in | 0.320 in | 5 lbs | 5 lbs | 14° to 200°F (-10° to 94°C) | 14° to 200°F (-10° to 94°C) | E50DH1 |
| Top Pushbutton | | | | | | | | |
|  Spring return | 0.040 in | 0.020 in | 0.280 in | 4 lbs | 8 oz | 14° to 250°F (-10° to 121°C) | 14° to 221°F (-10° to 105°C) | E50DT1 |
|  Adjustable Spring Return | 0.040 in | 0.020 in | 0.280 in | 4 lbs | 8 oz | 14° to 250°F (-10° to 121°C) | 14° to 221°F (-10° to 105°C) | E50DT2 |

Notes

- ① Temperature ranges below 32°F (0°C) are based on absence of freezing moisture or water.
- ② CW (clockwise) and CCW (counterclockwise) operation, easily convertible to CW only or CCW only operation.
- ③ For CW and CCW operation. For CW only or CCW only operation, high temperature limit increases to 250°F (121°C) without cable, and 221°F (105°C) with pre-wired cable.
- ④ Roller can be converted in the field between horizontal and vertical.
- ⑤ Roller shaft is 0.38 in (9.5 mm) longer on E50DS4, see Dimensions on [Page V8-T2-66](#).

E50 Heavy-Duty Plug-In Switches, Operating Heads, continued

| Description | Travel to Operate Contacts | Travel to Reset Contacts | Total Travel | Force to Operate Contacts | Minimum Return Force | Operating Temperature ^① | | Catalog Number |
|---|----------------------------|--------------------------|--------------|---------------------------|----------------------|------------------------------------|---------------------------------|----------------|
| | | | | | | Without Cable | With Pre-wired Cable | |
| Top Push Roller | | | | | | | | |
| Top Push Roller | | | | | | | | |
| Spring return | 0.040 in | 0.020 in | 0.280 in | 4 lbs | 8 oz | 14° to 250°F (-10° to 121°C) | 14° to 221°F (-10° to 105°C) | E50DT3 |
| Wobble Head, Spring Return (requires a wobble operator, see Page V8-T2-80) | | | | | | | | |
| Standard duty | 10° | 6° | 15° | 2 in-lbs | 2.4 in-oz | 14° to 250°F (-10° to 121°C) | 14° to 221°F (-10° to 105°C) | E50DW1 |
| Heavy-duty high strength steel | 10° | 6° | 15° | 2 in-lbs | 2.4 in-oz | 14° to 250°F (-10° to 121°C) | 14° to 221°F (-10° to 105°C) | E50DW2 |



Switch Bodies

E50 Heavy-Duty Plug-In Switches, Switch Bodies



| Switch Body Construction ^① | Single-Pole 1NO-1NC Catalog Number | Two-Pole 2NO-2NC Parallel Wired Indicator Light Catalog Number | Two-Pole 2NC-1NO Series Wired Indicator Light Catalog Number |
|---|---------------------------------------|--|--|
| Without indicating light | E50SA CE | E50SB | — |
| With LED indicating light 24–120 Vac/dc | E50SAL | E50SBL | E50SCL |
| With neon indicating light 120 Vac | E50SAN | E50SBN | — |









Circuit Diagrams, see **Page V8-T2-65**.

Note

^① Indicating lights are supplied from the factory wired as shown in Circuit Diagrams on **Page V8-T2-65**. However, they can be easily re-connected to terminals 1 and 2 if necessary (SPDT).

Receptacles

E50 Heavy-Duty Plug-In Switches, Receptacles

| | Description | Poles | Conduit Entrance | Cable Length | Catalog Number |
|---|--|--------------------------|----------------------|--------------|--|
| Surface Mount  | Surface Mount Conduit entrance, front or rear mounting | Single-pole (5 terminal) | 1/2 NPT | — | E50RA |
| | | | 20 mm | — | E50RA20 |
| | | Two-pole (9 terminal) | 1/2 NPT | — | E50RB |
| | | | 3/4 NPT | — | E50RB34 |
| | | | 20 mm | — | E50RB20 |
| Manifold Mount  | Manifold Mount Rear wiring entrance instead of conduit hole, gasket on back for oil tightness | Single-pole (5 terminal) | — | — | E50RAM |
| | | Two-pole (9 terminal) | — | — | E50RBM |
| Mini-Connector  | Mini-Connector Epoxy filled receptacle with pre-wired mini-connector. (The -W version is a wiring scheme typically used in automotive applications.) | Single-pole (5 terminal) | 5-pin mini-connector | — | E50RAP5  |
| | | | | — | E50RAP5-W  |
| | | Two-pole (9 terminal) | 9-pin mini-connector | — | E50RBP9  |
| Micro-Connector  | Micro-Connector Epoxy filled receptacle with M12 DC micro-connector | Single-pole (5 terminal) | — | — | E50RAA5 ^① |
| Pre-Wired Cable  | Pre-Wired Cable Epoxy filled receptacle with pre-wired 16 gauge, yellow jacketed, type SOOW-A cable. Cable enters through hole threaded for conduit. | Single-pole (5 terminal) | 1/2 NPT | 8 ft | E50RAS |
| | | | | 12 ft | E50RAS12 |
| | | | | 20 ft | E50RAS20 |
| | | | 20 mm | 8 ft | E50RA20S |
| | | | | 12 ft | E50RA20S12 |
| | | | | 20 ft | E50RA20S20 |
| | | Two-pole (9 terminal) | 1/2 NPT | 8 ft | E50RBS |
| | | | | 12 ft | E50RBS12 |
| | | | 20 mm | 20 ft | E50RBS20 |
| | | | | 8 ft | E50RB20S |
| 12 ft | E50RB20S12 | | | | |
| 20 ft | E50RB20S20 | | | | |

Wiring Diagrams, see Page V8-T2-65.

Notes

 See listing of compatible connector cables on Page V8-T2-62.

^① Model E50RAA5 is not UL listed or CSA certified.

2.6





Limit Switches

E50 Heavy-Duty Plug-In Switches

2

Compatible Connector Cables

Standard Cables ^①

| | Current Rating at 600V | Voltage Style | Number of Pins | Gauge | Length | Pin Configuration/Wire Colors (Face View Female Shown) | Catalog Number |
|--|------------------------------------|---------------|----------------|--------|-------------|--|----------------------|
| Mini-style Straight Female  | Mini-Style, Straight Female | | | | | | |
| | 8A | — | 5-pin | 16 AWG | 6 ft (2m) |  1-White 2-Red 3-Green 4-Orange 5-Black | CSMS5D5CY1602 |
| | 7A | — | 9-pin | 16 AWG | 12 ft (4m) |  1-Orange 2-Blue 3-Red/Black 4-Green/Black 5-White 6-Red 7-Green 8-White/Black 9-Black | CSMS9D9CY1602 |
| Micro-Style  | Micro-Style | | | | | | |
| | 4A | — | 5-pin, 5-wire | 22 AWG | 6.0 ft (2m) |  1-Brown 2-White 3-Blue 4-Black 5-Green/Yellow | CSDS5A5CY2202 |

Accessories

E50 Heavy-Duty Plug-In Switch Accessories





| | Description | Catalog Number |
|--|---|----------------|
| E50KH7  | Adapter Plate | |
| | Allows E50 to replace Square D Type AW Surface Mounting Non Plug-In Standard Box Limit Switch | E50KH7 |

Dimensions, see **Page V8-T2-67**.

Note

^① For a full selection of connector cables, see **Tab 10, section 10.1**.

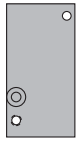
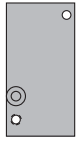
E50 Heavy-Duty Plug-In Switch Accessories, continued

| Description | Catalog Number |
|---|---|
| Adapter Plate, continued | |
| E50KH4 | E50KH4 ① |
|  | Allows E50 to replace National Acme, Type D-1200M, Style 2 Mounting. Denison LoxSwitch, Model L-100W, Style 2 Mounting. Square D 9007 Type T, Style B Mounting. (Adapter plate is 1/8 in thick, with 1/4 in mounting holes.) Namco® long mount. |
| E50KH5 | E50KH5 ① |
|  | Allows E50 to replace National Acme, Type D-1200M, Style 1 Mounting. Denison LoxSwitch, Model L-100W, Style 1 Mounting. Square D 9007 Type T, Style C Mounting. (Adapter plate is 1/8 in thick, with 1/4 in mounting holes.) |
| E50KH2 | E50KH2 |
|  | Allows E50 to replace Eaton's 10316 Type LT Non Plug-In Two-Pole Limit Switch |
| E50KH10 | E50KH10 |
|  | Allows E50 to replace Allen-Bradley 802M Sealed Limit Switch |
| Adjustable Mounting Plate | |
| E50KH3 | E50KH3 ① |
|  | This is a mounting plate only 5/16 in thick and includes the proper mounting bolts and nuts. The slots in the plate allow a maximum horizontal adjustment of 1 in and vertical adjustment of 1-1/4 in |
| Conduit Sealing Nut | |
| E50KH6 | E50KH6 |
|  | 1/2 in oiltight |
| Dimensions, see Page V8-T2-67. | |

Note

① Limit switch not included.

Technical Data and Specifications

2

E50 Heavy-Duty Plug-In Switches

| Description | Specification |
|--|--|
| Environmental ratings | NEMA 1, 3, 3S, 4, 4X, 6, 6P, 13, IP67 |
| Material of construction | Zinc die cast |
| Switch gasket material | Viton |
| Universal U.S./DIN mounting dimensions | 1.16 in (30 mm) x 2.34 in (60 mm) |
| Conduit entrance | 1/2 in NPT or 20 mm threading |
| Contact ratings | See below |
| Contact operation | Snap action over center mechanism |
| Contact material | Fine silver |
| Maximum frequency of operation | 8000 operations per hour |
| Mechanical life | |
| Side rotary | 13,000,000 operations minimum |
| Side or top push | 10,000,000 operations minimum |
| Electrical life | |
| Single-pole | 1,000,000 operations typical at full load |
| Two-pole | 100,000 operations typical at full load |
| Ambient temperature range—standard | |
| Standard without cable | 14° to 250°F (–10° to 121°C) |
| Standard with cable | 14° to 221°F (–10° to 105°C) |
| Low temperature without cable | –40° to 250°F (–40° to 121°C) |
| Low temperature with cable | –40° to 221°F (–40° to 105°C) |
| Repeat accuracy—standard | |
| Side operated | Within 0.0012 in |
| Top operated | Within 0.0003 in |
| Side rotary | Within 0.0014 in |
| Torque requirements: | |
| Switch body screws | 25–30 lb-in |
| Operating head screws | 14–18 lb-in |
| Wire size | Will accept AWG #22–#12, single or stranded wire |

Electrical Data—Maximum Contact Ratings (Same polarity each pole)

| AC Volts | Current, Amperes | | | Voltamperes | | DC Volts | Current, Amperes | |
|---|------------------|-------|---------|-------------|-------|-----------|--------------------|---------|
| | Make | Break | Cont. ① | Make | Break | | Max. Make or Break | Cont. ① |
| All Switches Except Gravity Return and Indicating Light Versions | | | | | | | | |
| NEMA A600 Rating | | | | | | NEMA R300 | | |
| 120 | 60 | 6 | 10 | 7200 | 720 | 125 | 0.22 | 1.0 |
| 240 | 30 | 3 | 10 | 7200 | 720 | 250 | 0.11 | 1.0 |
| 480 | 15 | 1.5 | 10 | 7200 | 720 | 250 | 0.11 | 1.0 |
| 600 | 12 | 1.2 | 10 | 7200 | 720 | 250 | 0.11 | 1.0 |
| Switches with Indicating Lights (LED or Neon) | | | | | | | | |
| NEMA A150 Rating | | | | | | NEMA R150 | | |
| 120 | 60 | 6 | 10 | 7200 | 720 | 125 | 0.22 | 1.0 |
| Gravity Return Switches—Maximum Contact Ratings | | | | | | | | |
| NEMA 6600 Rating—Contacts on same polarity | | | | | | | | |
| 120 | 30 | 3 | 5 | 3600 | 360 | — | — | — |
| 240 | 15 | 1.5 | 5 | 3600 | 360 | — | — | — |
| 480 | 7.5 | 0.75 | 5 | 3600 | 360 | — | — | — |
| 600 | 6 | 0.60 | 5 | 3600 | 360 | — | — | — |

Note

① Thermal rating. Valid only if switch does not have to make or break.

Circuit Diagrams

Standard Assembled Switches and Switch Bodies

Single-Pole 1NO-1NC

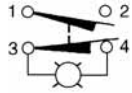

Must be same polarity.

Two-Pole 2NO-2NC

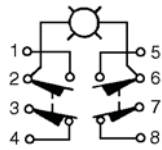

Parallel wired indicator light. Same polarity each pole.

Two-Pole 1NO-2NC

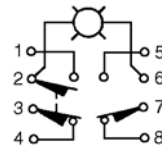

Series wired indicator light. Same polarity each pole.

Special Purpose Assembled Switches

Neutral Position

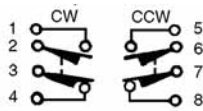

Same polarity, each pole.

Two-Step (CW, CCW, or Both)

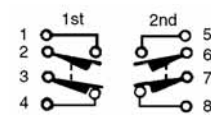

Same polarity, each pole.

Gravity Return

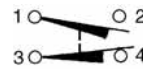

Must be same polarity.

Wiring Diagrams

Receptacles ①

E50RAP5

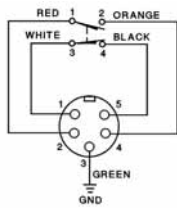

E50RAP5-W

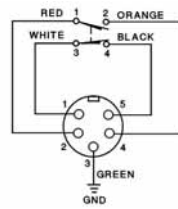

E50RBP9

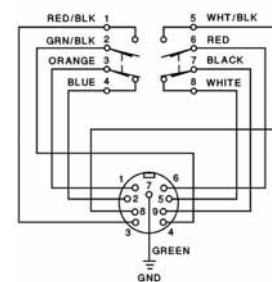

E50RAA5

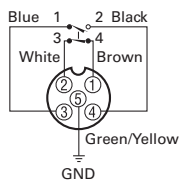

E50RAS_

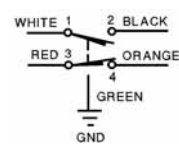

E50RBS_

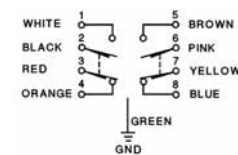

Note

① The wire colors referenced on these diagrams are those internal to the switch itself.

2.6

Limit Switches

E50 Heavy-Duty Plug-In Switches

Dimensions

Approximate Dimensions in Inches (mm)

2

Standard

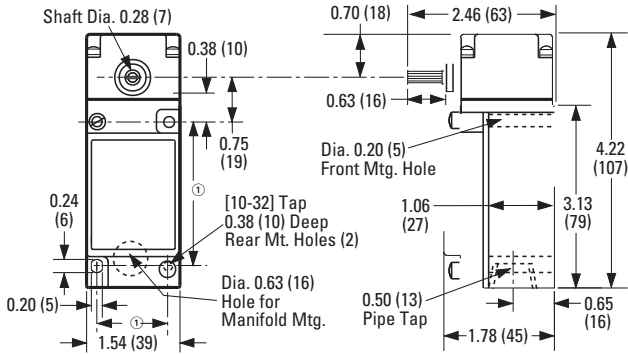

E50SB34

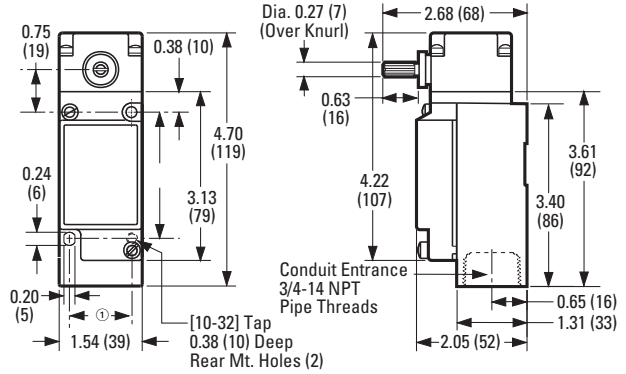

Side Push Operators

Approximate Dimensions in mm [in]

Pushbutton

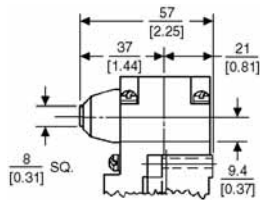

Adjustable Pushbutton

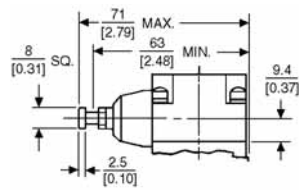

Roller

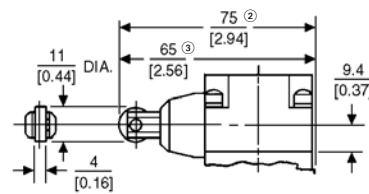

Maintained Pushbutton

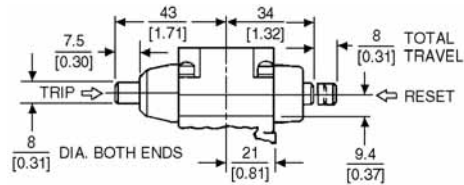

Top Push Operators

Pushbutton

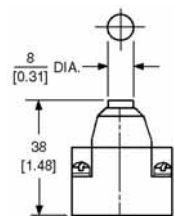

Adjustable Pushbutton

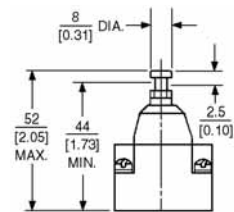

Roller

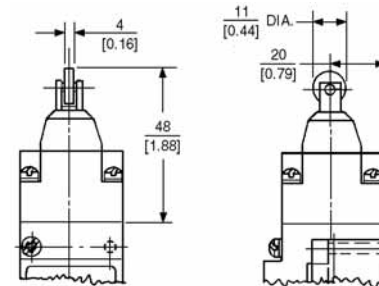

Wobble Operators

See Operators on Page V8-T2-80.

Notes

- ① Can accommodate both U.S., 1.16 (29.4) x 2.34 (59.5) and DIN, 1.18 (30) x 3.26 (60), mounting dimensions.
- ② For E50DS4.
- ③ For E50DS3.

Accessories

Approximate Dimensions in mm [in]

Adapter Plates

E50KH1M

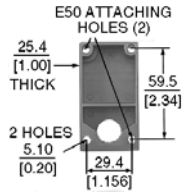

E50KH7

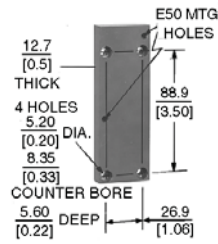

E50KH4

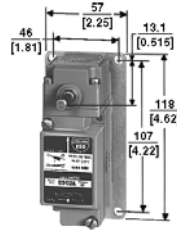

E50KH5

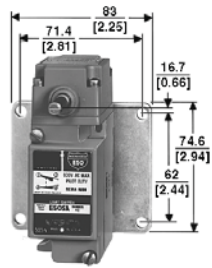

E50KH2

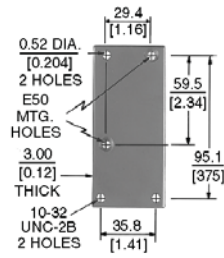

E50KH10

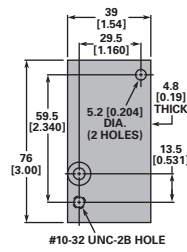

Adjustable Mounting Plate

E50KH3

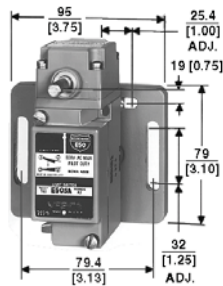

E50 Heavy-Duty Factory Sealed 6P+ Switches

2



Contents

Description

Page

| | |
|--|----------|
| E50 Heavy-Duty Factory Sealed 6P+ Switches | |
| Product Selection | |
| Assembled Switches—Standard | V8-T2-69 |
| Operating Heads | V8-T2-72 |
| Switch Bodies | V8-T2-73 |
| Compatible Connector Cables | V8-T2-74 |
| Accessories | V8-T2-74 |
| Technical Data and Specifications | V8-T2-76 |
| Circuit Diagrams | V8-T2-77 |
| Wiring Diagrams | V8-T2-77 |
| Dimensions | V8-T2-78 |



Drawings
Online

E50 Heavy-Duty Factory Sealed 6P+ Switches

Product Description

E50 6P+ Limit Switches by Eaton's electrical sector were specifically designed to withstand the penetrating properties of cutting fluids and coolants, such as those used in the automotive industry, as well as extreme shock, vibration and temperature fluctuations. The one-piece, epoxy filled switch body is prewired at the factory to ensure leak-proof, submersible performance. This unique construction positively stops fluid from finding its way to any and all critical connections.

Our 6P+ switches can be ordered in separate components or as complete assembled devices. They are available with prewired 16 AWG cables or mini-connectors. Standard and custom cable lengths are available. As part of the E50 line, the 6P+ switches use the same operating heads as the standard E50 plug-in models to reduce the components you need to inventory.

Features

- Manufactured to take the physical and environmental abuse (including cutting fluids and chemicals) of harsh industrial environments
- Modular, plug-in components (head and switch body) provide application flexibility, reduced inventory and less downtime
- Chemical resistant Viton gaskets, seals and boots are standard, and so are captive, posi-drive screws
- A special tertiary seal on the switch body prevents fluid from entering even when the operating head is not attached
- 600V rating, ridge-topped contacts and wiping action assure continuity even to logic level circuits
- Factory wired cable features a 350 pound pullout capacity
- Keyed, four direction head positioning. Standard 5° pre-travel and 90° total travel
- 24–120 Vac/dc LED and 120 Vac neon indicating lights available
- Rotary heads are field convertible CW, CCW, or both, without special tools

Standards and Certifications

- UL Listed
- CSA Certified
- IEC.9475.1
- TUV—E9271605E02
- CE (where shown)



⚠ DANGER

THIS SENSOR IS NOT A SAFETY DEVICE AND IS NOT INTENDED TO BE USED AS A SAFETY DEVICE. This sensor is designed only to detect and read certain data in an electronic manner and perform no use apart from that, specifically no safety-related use. This sensor product does not include self-checking redundant circuitry, and the failure of this sensor product could cause either an energized or de-energized output condition, which could result in death, serious bodily injury, or property damage.

For the most current information on this product, visit our Web site: www.eaton.com

For Customer Service in the U.S. call 1-877-ETN CARE (386-2273), in Canada call 1-800-268-3578.
For Application Assistance in the U.S. and Canada call 1-800-426-9184.

Product Selection

Assembled Switches—Standard

Connection is by 8 ft cable ①.

Assembled Switch E50 Heavy-Duty Factory Sealed 6P+ Switches, Assembled—Standard



Lever sold separately



Single-Pole



Two-Pole

| | | | | | | |
|--------------------------|--------------------|---------------------|---------------------|--------------------|---------------------|---------------------|
| Indicating Light: | None | LED (24–120 Vac/dc) | Neon (120 Vac) | None | LED (24–120 Vac/dc) | Neon (120 Vac) |
| Switch Body: | E50SA6P 1NO-1NC | E50SAL6P 1NO-1NC | E50SAN6P 1NO-1NC | E50SB6P 2NO-2NC | E50SBL6P 2NO-2NC | E50SBN6P 2NO-2NC |

Operating Head Type ②

Side Rotary



| Description | Assembled Switch Catalog Number | | | Assembled Switch Catalog Number | | |
|---|---------------------------------|-----------|-----------|---------------------------------|-----------|-----------|
| Side Rotary (requires an operating lever, see Page V8-T2-80) | | | | | | |
| Standard spring return—E50DR1 ③ | E50AR16P C C | E50ALR16P | E50ANR16P | E50BR16P | E50BLR16P | E50BNR16P |
| Low force spring return—E50DL1 ③ | E50AL16P C C | E50ALL16P | E50ANL16P | E50BL16P | E50BLL16P | E50BNL16P |
| Maintained two-position—E50DM1 | E50AM16P C C | E50ALM16P | E50ANM16P | E50BM16P | E50BLM16P | E50BNM16P |

Spring Return



| | | | | | | |
|----------------------|-----------------|-----------|-----------|----------|-----------|-----------|
| Spring return—E50DS1 | E50AS16P C C | E50ALS16P | E50ANS16P | E50BS16P | E50BLS16P | E50BNS16P |
|----------------------|-----------------|-----------|-----------|----------|-----------|-----------|

Adjustable Spring Return



| | | | | | | |
|---------------------------------|-----------------|-----------|-----------|----------|-----------|-----------|
| Adjustable spring return—E50DS2 | E50AS26P C C | E50ALS26P | E50ANS26P | E50BS26P | E50BLS26P | E50BNS26P |
|---------------------------------|-----------------|-----------|-----------|----------|-----------|-----------|

Circuit Diagrams, see Page V8-T2-77.

Notes

① Connection options (add the code suffix from the table below to the end of the catalog number):

| Option | | Catalog Number | Code Suffix |
|------------------|------------------------------------|----------------|--------------|
| Mini-connector ④ | Single-pole (5-pin mini-connector) | CSMS5D5CY1602 | C |
| | Two-pole (9-pin mini-connector) | CSMS9D9CY1602 | C |
| Cable connection | 12 ft cable length (standard) | — | 12 |
| | 20 ft cable length (standard) | — | 20 |
| | Other lengths (special order) | — | Length in ft |

② For operating head specifications, see Page V8-T2-72.

③ CW (clockwise) and CCW (counterclockwise) operation, easily convertible to CW only or CCW only operation.

④ For a full selection of connector cables, see Tab 10, section 10.1.

2.7

Limit Switches

E50 Heavy-Duty Factory Sealed 6P+ Switches

Connection is by 8 ft cable ①.

2

Assembled Switch

E50 Heavy-Duty Factory Sealed 6P+ Switches, Assembled—Standard, continued



Lever sold separately



Single-Pole



Two-Pole

| Indicating Light: | Single-Pole | | | Two-Pole | | |
|------------------------------|--|------------------------|---------------------|--|------------------------|---------------------|
| | None | LED (24–120 Vac/dc) | Neon (120 Vac) | None | LED (24–120 Vac/dc) | Neon (120 Vac) |
| Switch Body: | E50SA6P 1N0-1NC | E50SAL6P 1N0-1NC | E50SAN6P 1N0-1NC | E50SB6P 2N0-2NC | E50SBL6P 2N0-2NC | E50SBN6P 2N0-2NC |
| Operating Head Type ② | Description | | | Description | | |
| | Assembled Switch Catalog Number | | | Assembled Switch Catalog Number | | |

Operating Head Type ②

Side Push Roller



| Description | Single-Pole | | | Two-Pole | | |
|------------------------|---------------------------------|---------------------------------|---------------------------------|---------------------------------|---------------------------------|---------------------------------|
| | Assembled Switch Catalog Number | Assembled Switch Catalog Number | Assembled Switch Catalog Number | Assembled Switch Catalog Number | Assembled Switch Catalog Number | Assembled Switch Catalog Number |
| Side Push Roller | | | | | | |
| Spring return—E50DS3 ③ | E50AS36P CE | E50ALS36P | E50ANS36P | E50BS36P | E50BLS36P | E50BNS36P |

Side Pushbutton



| Description | Single-Pole | | | Two-Pole | | |
|-------------------|---------------------------------|---------------------------------|---------------------------------|---------------------------------|---------------------------------|---------------------------------|
| | Assembled Switch Catalog Number | Assembled Switch Catalog Number | Assembled Switch Catalog Number | Assembled Switch Catalog Number | Assembled Switch Catalog Number | Assembled Switch Catalog Number |
| Side Pushbutton | | | | | | |
| Maintained—E50DH1 | E50AH16P CE | E50ALH16P | E50ANH16P | E50BH16P | E50BLH16P | E50BNH16P |

Top Pushbutton

Spring Return



| Description | Single-Pole | | | Two-Pole | | |
|----------------------|---------------------------------|---------------------------------|---------------------------------|---------------------------------|---------------------------------|---------------------------------|
| | Assembled Switch Catalog Number | Assembled Switch Catalog Number | Assembled Switch Catalog Number | Assembled Switch Catalog Number | Assembled Switch Catalog Number | Assembled Switch Catalog Number |
| Spring return—E50DT1 | E50AT16P CE | E50ALT16P | E50ANT16P | E50BT16P | E50BLT16P | E50BNT16P |

Adjustable Spring Return



| Description | Single-Pole | | | Two-Pole | | |
|---------------------------------|---------------------------------|---------------------------------|---------------------------------|---------------------------------|---------------------------------|---------------------------------|
| | Assembled Switch Catalog Number | Assembled Switch Catalog Number | Assembled Switch Catalog Number | Assembled Switch Catalog Number | Assembled Switch Catalog Number | Assembled Switch Catalog Number |
| Adjustable spring return—E50DT2 | E50AT26P CE | E50ALT26P | E50ANT26P | E50BT26P | E50BLT26P | E50BNT26P |

Circuit Diagrams, see Page V8-T2-77.

Notes

① Connection options (add the code suffix from the table below to the end of the catalog number):

| Option | | Catalog Number | Code Suffix |
|------------------|------------------------------------|----------------|--------------|
| Mini-connector ④ | Single-pole (5-pin mini-connector) | CSMS5D5CY1602 | C |
| | Two-pole (9-pin mini-connector) | CSMS9D9CY1602 | C |
| Cable connection | 12 ft cable length (standard) | — | 12 |
| | 20 ft cable length (standard) | — | 20 |
| | Other lengths (special order) | — | Length in ft |

② For operating head specifications, see Page V8-T2-72.

③ Roller can be converted in the field between horizontal and vertical.

④ For a full selection of connector cables, see Tab 10, section 10.1.

Connection is by 8 ft cable ①.

Assembled Switch

E50 Heavy-Duty Factory Sealed 6P+ Switches, Assembled—Standard, continued



Lever sold separately



Single-Pole



Two-Pole

| | | | | | | |
|--------------------------|--------------------|------------------------|---------------------|--------------------|------------------------|---------------------|
| Indicating Light: | None | LED (24–120 Vac/dc) | Neon (120 Vac) | None | LED (24–120 Vac/dc) | Neon (120 Vac) |
| Switch Body: | E50SA6P 1NO-1NC | E50SAL6P 1NO-1NC | E50SAN6P 1NO-1NC | E50SB6P 2NO-2NC | E50SBL6P 2NO-2NC | E50SBN6P 2NO-2NC |

Operating Head Type ②

| Description | Assembled Switch Catalog Number | | | Assembled Switch Catalog Number | | |
|-------------|---------------------------------|--|--|---------------------------------|--|--|
|-------------|---------------------------------|--|--|---------------------------------|--|--|

Top Push Roller

| | | | | | | |
|------------------------|--|--|--|--|--|--|
| Top Push Roller | | | | | | |
|------------------------|--|--|--|--|--|--|



| | | | | | | |
|--------------------------|----------------|-----------|-----------|----------|-----------|-----------|
| Spring return— E50DT3 | E50AT36P CE | E50ALT36P | E50ANT36P | E50BT36P | E50BLT36P | E50BNT36P |
|--------------------------|----------------|-----------|-----------|----------|-----------|-----------|

Wobble Head, Spring Return

| | | | | | | |
|---|--|--|--|--|--|--|
| Wobble Head, Spring Return (requires a wobble operator, see Page V8-T2-80) | | | | | | |
|---|--|--|--|--|--|--|



| | | | | | | |
|--|----------------|-----------|-----------|----------|-----------|-----------|
| Standard duty— E50DW1 | E50AW16P CE | E50ALW16P | E50ANW16P | E50BW16P | E50BLW16P | E50BNW16P |
| Heavy-duty high strength steel— E50DW2 | E50AW26P CE | E50ALW26P | E50ANW26P | E50BW26P | E50BLW26P | E50BNW26P |

Circuit Diagrams, see Page V8-T2-77.

Notes

① Connection options (add the code suffix from the table below to the end of the catalog number):

| Option | | Catalog Number | Code Suffix |
|------------------|------------------------------------|----------------|--------------|
| Mini-connector ③ | Single-pole (5-pin mini-connector) | CSMS5D5CY1602 | C |
| | Double-pole (9-pin mini-connector) | CSMS9D9CY1602 | C |
| Cable connection | 12 ft cable length (standard) | — | 12 |
| | 20 ft cable length (standard) | — | 20 |
| | Other lengths (special order) | — | Length in ft |







② For operating head specifications, see Page V8-T2-72.

③ For a full selection of connector cables, see Tab 10, section 10.1.

Operating Heads

2

E50 Heavy-Duty Factory Sealed 6P+ Switches, Operating Heads

| Description | Travel to Operate Contacts | Travel to Reset Contacts | Total Travel | Force to Operate Contacts | Minimum Return Force | Operating Temperature ^① | | Catalog Number |
|---|--|--------------------------|--------------|---------------------------|----------------------|---|---|----------------------------|
| | | | | | | Without Cable | With Pre-wired Cable | |
| Side Rotary | Side Rotary (requires an operating lever, see Page V8-T2-80) | | | | | | | |
|  Standard spring return ^② | 5° | 2° | 90° | 3 in-lbs | 4.5 in-oz | 10° to 200°F (-12° to 94°C) ^③ | 10° to 200°F (-12° to 94°C) ^③ | E50DR1 |
| Low temperature spring return ^② | 5° | 2° | 90° | 3 in-lbs | 4.5 in-oz | -40° to 175°F (-40° to 79°C) | -31° to 175°F (-34° to 79°C) | E50DR19 |
| Low force spring return ^② | 15° | 6° | 90° | 1.5 in-lbs | 2.5 in-oz | 10° to 200°F (-12° to 94°C) ^③ | 10° to 200°F (-12° to 94°C) ^③ | E50DL1 |
| Maintained two-position | 50° | 50° | 90° | 3 in-lbs | — | 14° to 200°F (-10° to 94°C) | 14° to 200°F (-10° to 94°C) | E50DM1 |
| Side Pushbutton | Side Pushbutton | | | | | | | |
|  Spring return | 0.065 in | 0.030 in | 0.250 in | 4 lbs | 8 oz | 14° to 200°F (-10° to 94°C) | 14° to 200°F (-10° to 94°C) | E50DS1 |
| Adjustable Spring Return | Adjustable Spring Return | | | | | | | |
|  Adjustable spring return | 0.065 in | 0.030 in | 0.250 in | 4 lbs | 8 oz | 14° to 200°F (-10° to 94°C) | 14° to 200°F (-10° to 94°C) | E50DS2 |
| Side Push Roller | Side Push Roller | | | | | | | |
|  Spring return ^④ | 0.065 in | 0.030 in | 0.250 in | 4 lbs | 8 oz | 14° to 200°F (-10° to 94°C) | 14° to 200°F (-10° to 94°C) | E50DS3 ^⑤ |
| | 0.065 in | 0.030 in | 0.250 in | 4 lbs | 8 oz | 14° to 200°F (-10° to 94°C) | 14° to 200°F (-10° to 94°C) | E50DS4 ^⑤ |
| Side Pushbutton | Side Pushbutton | | | | | | | |
|  Maintained | 0.200 in | 0.130 in | 0.320 in | 5 lbs | 5 lbs | 14° to 200°F (-10° to 94°C) | 14° to 200°F (-10° to 94°C) | E50DH1 |
| Top Pushbutton | Top Pushbutton | | | | | | | |
|  Spring return | 0.040 in | 0.020 in | 0.280 in | 4 lbs | 8 oz | 14° to 250°F (-10° to 121°C) | 14° to 221°F (-10° to 105°C) | E50DT1 |
| Adjustable Spring Return | Adjustable Spring Return | | | | | | | |
|  Adjustable spring return | 0.040 in | 0.020 in | 0.280 in | 4 lbs | 8 oz | 14° to 250°F (-10° to 121°C) | 14° to 221°F (-10° to 105°C) | E50DT2 |

Notes

- ① Temperature ranges below 32°F (0°C) are based on absence of freezing moisture or water.
- ② CW (clockwise) and CCW (counterclockwise) operation, easily convertible to CW only or CCW only operation.
- ③ For CW and CCW operation. For CW only or CCW only operation, high temperature limit increases to 250°F (121°C) without cable, and 221°F (105°C) with pre-wired cable.
- ④ Roller can be converted in the field between horizontal and vertical.
- ⑤ Roller shaft is 0.38 in (9.5 mm) longer on E50DS4, see Dimensions on [Page V8-T2-78](#).

E50 Heavy-Duty Factory Sealed 6P+ Switches

E50 Heavy-Duty Factory Sealed 6P+ Switches, Operating Heads, continued

| Description | Travel to Operate Contacts | Travel to Reset Contacts | Total Travel | Force to Operate Contacts | Minimum Return Force | Operating Temperature ^① | | Catalog Number |
|-----------------------------------|--|--------------------------|--------------|---------------------------|----------------------|------------------------------------|---------------------------------|----------------|
| | | | | | | Without Cable | With Pre-Wired Cable | |
| Top Push Roller | Top Push Roller | | | | | | | |
| Spring return | 0.040 in | 0.020 in | 0.280 in | 4 lbs | 8 oz | 14° to 250°F (-10° to 121°C) | 14° to 221°F (-10° to 105°C) | E50DT3 |
| Wobble Head, Spring Return | Wobble Head, Spring Return (requires a wobble operator, see Page V8-T2-80) | | | | | | | |
| Standard duty | 10° | 6° | 15° | 2 in-lbs | 2.4 in-oz | 14° to 250°F (-10° to 121°C) | 14° to 221°F (-10° to 105°C) | E50DW1 |
| Heavy-duty high strength steel | 10° | 6° | 15° | 2 in-lbs | 2.4 in-oz | 14° to 250°F (-10° to 121°C) | 14° to 221°F (-10° to 105°C) | E50DW2 |

Circuit Diagrams, see [Page V8-T2-77](#).

Switch Bodies

E50 Heavy-Duty Factory Sealed 6P+, Switch Bodies

| Circuit | Switch Body Construction | Cable Length | Catalog Number |
|------------------------|---|--------------|---------------------|
| Pre-Wired Cable | Pre-Wired Cable | | |
| Single-pole 1NO-1NC | Without indicating light | 8 ft | E50SA6P |
| | | 12 ft | E50SA6P12 |
| | | 20 ft | E50SA6P20 |
| | With LED indicating light 24–120 Vac/dc | 8 ft | E50SAL6P |
| | | 12 ft | E50SAL6P12 |
| | | 20 ft | E50SAL6P20 |
| | With neon indicating light 120 Vac | 8 ft | E50SAN6P |
| | | 12 ft | E50SAN6P12 |
| | | 20 ft | E50SAN6P20 |
| Two-pole 2NO-2NC | Without indicating light | 8 ft | E50SB6P |
| | | 12 ft | E50SB6P12 |
| | | 20 ft | E50SB6P20 |
| | With LED indicating light 24–120 Vac/dc | 8 ft | E50SBL6P |
| | | 12 ft | E50SBL6P12 |
| | | 20 ft | E50SBL6P20 |
| | With neon indicating light 120 Vac | 8 ft | E50SBN6P |
| | | 12 ft | E50SBN6P12 |
| | | 20 ft | E50SBN6P20 |
| Mini-Connector | Mini-Connector | | |
| Single-pole 1NO-1NC | Without indicating light normal wiring | — | E50SA6PC ☼ |
| | Without indicating light alternate wiring | — | E50SA6PC-W ☼ |
| | With LED indicating light 24–120 Vac/dc | — | E50SAL6PC ☼ |
| | With neon indicating light 120 Vac | — | E50SAN6PC ☼ |
| Two-pole 2NO-2NC | Without indicating light | — | E50SB6PC ☼ |
| | With LED indicating light 24–120 Vac/dc | — | E50SBL6PC ☼ |
| | With neon indicating light 120 Vac | — | E50SBN6PC ☼ |

Notes



☼ See listing of compatible connector cables on [Page V8-T2-74](#).

① Temperature ranges below 32°F (0°C) are based on absence of freezing moisture or water.

Compatible Connector Cables



2

Standard Cables ^①

| | Current Rating at 600V | Voltage Style | Number of Pins | Gauge | Length | Pin Configuration/Wire Colors (Face View Female Shown) | Catalog Number |
|---|------------------------------------|---------------|----------------|--------|------------|--|----------------------|
| Mini-Style, Straight Female  | Mini-Style, Straight Female | | | | | | |
| | 8A | — | 5-pin | 16 AWG | 6 ft (2m) |  <ul style="list-style-type: none"> 1-White 2-Red 3-Green 4-Orange 5-Black | CSMS5D5CY1602 |
| | 7A | — | 9-pin | 16 AWG | 12 ft (4m) |  <ul style="list-style-type: none"> 1-Orange 2-Blue 3-Red/Black 4-Green/Black 5-White 6-Red 7-Green 8-White/Black 9-Black | CSMS9D9CY1602 |

Accessories

E50 Heavy-Duty Factory Sealed 6P+ Switch Accessories





| | | Catalog Number |
|--|---|----------------|
| E50KH1M  | Adapter Plate | |
| | Allows E50 to replace Eaton's 10316 Type LP Manifold Mounting Plug-In Limit Switch | E50KH1M |
| E50KH7  | Allows E50 to replace Square D Type AW Surface Mounting Non Plug-In Standard Box Limit Switch | E50KH7 |

Dimensions, see **Page V8-T2-78**.

Note

^① For a full selection of connector cables, see **Tab 10, section 10.1**.

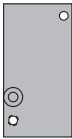
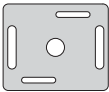
E50 Heavy-Duty Factory Sealed 6P+ Switch Accessories, continued

| | | Catalog Number |
|---|---|-----------------|
| Adapter Plate, continued | | |
| E50KH4  | Allows E50 to replace National Acme, Type D-1200M, Style 2 Mounting. Denison LoxSwitch, Model L-100W, Style 2 Mounting. Square D 9007 Type T, Style B Mounting. (Adapter plate is 1/8 in thick, with 1/4 in mounting holes.) Namco® long mount. | E50KH4 ① |
| E50KH5  | Allows E50 to replace National Acme, Type D-1200M, Style 1 Mounting. Denison LoxSwitch, Model L-100W, Style 1 Mounting. Square D 9007 Type T, Style C Mounting. (Adapter plate is 1/8 in thick, with 1/4 in mounting holes.) | E50KH5 ① |
| E50KH2  | Allows E50 to replace Eaton's 10316 Type LT Non Plug-In Two-Pole Limit Switch | E50KH2 |
| E50KH10  | Allows E50 to replace Allen-Bradley 802M Sealed Limit Switch | E50KH10 |
| Adjustable Mounting Plate | | |
| E50KH3  | This is a mounting plate only 5/16 in thick and includes the proper mounting bolts and nuts. The slots in the plate allow a maximum horizontal adjustment of 1 in and vertical adjustment of 1-1/4 in | E50KH3 ① |
| Conduit Sealing Nut | | |
| E50KH6  | 1/2 in oiltight | E50KH6 |

Dimensions, see **Page V8-T2-78**.

Note

① Limit switch not included.

Technical Data and Specifications

2

E50 Heavy-Duty Factory Sealed 6P+ Switches

| Description | Specification |
|--|--|
| Environmental ratings | NEMA 1, 3, 3S, 4, 4X, 6, 6P, 13, IP67, IP69K |
| Material of construction | Zinc die cast |
| Switch gasket material | Viton |
| Universal U.S./DIN mounting dimensions | 1.16 in (30 mm) x 2.34 in (60 mm) |
| Conduit entrance | 1/2 in NPT or 20 mm threading |
| Contact ratings | See below |
| Contact operation | Snap action over center mechanism |
| Contact material | Fine silver |
| Maximum frequency of operation | 8000 operations per hour |
| Mechanical life | |
| Side rotary | 13,000,000 operations minimum |
| Side or top push | 10,000,000 operations minimum |
| Electrical life | |
| Single-pole | 1,000,000 operations typical at full load |
| Double-pole | 100,000 operations typical at full load |
| Ambient temperature range—standard | |
| Standard without cable | 14° to 250°F (–10° to 121°C) |
| Standard with cable | 14° to 221°F (–10° to 105°C) |
| Low temperature without cable | –40° to 250°F (–40° to 121°C) |
| Low temperature with cable | –40° to 221°F (–40° to 105°C) |
| Repeat accuracy—standard | |
| Side operated | Within 0.0012 in |
| Top operated | Within 0.0003 in |
| Side rotary | Within 0.0014 in |
| Torque requirements | |
| Operating head screws | 14–18 lb-in |

Electrical Data—Maximum Contact Ratings (Same polarity each pole)

| AC Volts | Current, Amperes | | | Voltamperes | | DC Volts | Current, Amperes | | |
|---|------------------|-------|---------|-------------|-------|-----------|--------------------|---------|--|
| | Make | Break | Cont. ① | Make | Break | | Max. Make or Break | Cont. ① | |
| All Switches Except Gravity Return and Indicating Light Versions | | | | | | | | | |
| NEMA A600 Rating | | | | | | NEMA R300 | | | |
| 120 | 60 | 6 | 10 | 7200 | 720 | 125 | 0.22 | 1.0 | |
| 240 | 30 | 3 | 10 | 7200 | 720 | 250 | 0.11 | 1.0 | |
| 480 | 15 | 1.5 | 10 | 7200 | 720 | 250 | 0.11 | 1.0 | |
| 600 | 12 | 1.2 | 10 | 7200 | 720 | 250 | 0.11 | 1.0 | |
| Switches with Indicating Lights (LED or Neon) | | | | | | | | | |
| NEMA A150 Rating | | | | | | NEMA R150 | | | |
| 120 | 60 | 6 | 10 | 7200 | 720 | 125 | 0.22 | 1.0 | |

Note

① Thermal rating. Valid only if switch does not have to make or break.

Circuit Diagrams ①

Standard Assembled Switches

Single-Pole 1NO-1NC

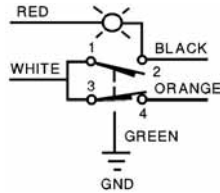
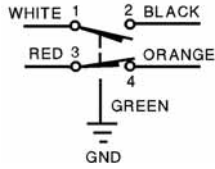

Must be same polarity.

Switch Bodies

**Pre-Wired Cable—
Single-Pole 1NO-1NC**

E50SA6P_

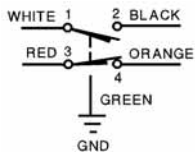

E50SAL6P_

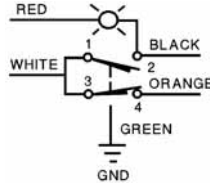

Two-Pole 2NO-2NC

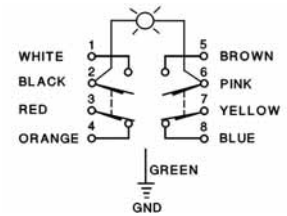
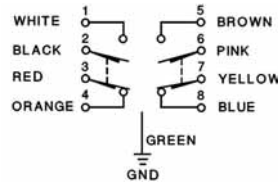

Same polarity, each pole.

**Pre-Wired Cable—
Two-Pole 2NO-2NC**

E50SB6P_

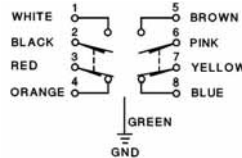

E50SBL6P_

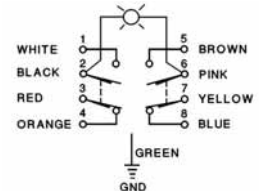

Wiring Diagrams ①

Mini-Connector—Single-Pole 1NO-1NC

E50SA6PC

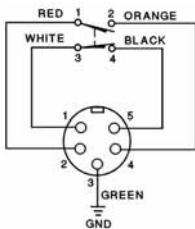

E50SA6PC-W

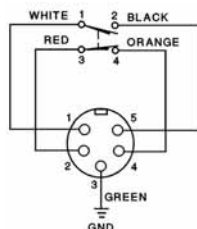

E50SAL6PC/E50SAN6PC

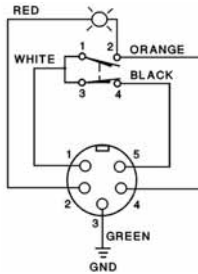

Mini-Connector—Two-Pole 2NO-2NC

E50SB6PC

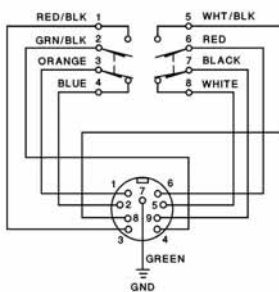

E50SBL6PC/E50SBN6PC

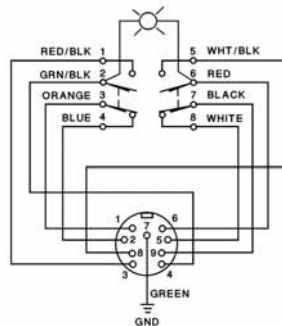

Note

① The wire colors referenced on these diagrams are those internal to the switch itself.

2.7

Limit Switches

E50 Heavy-Duty Factory Sealed 6P+ Switches

Dimensions

Approximate Dimensions in Inches (mm)

2

Standard

6P+ Limit Switch with Rotary Operating Head

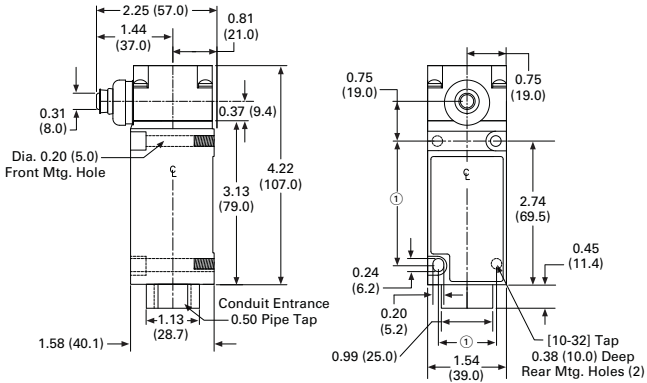

Side Push Operators

Approximate Dimensions in mm [in]

Pushbutton

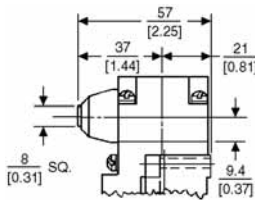

Adjustable Pushbutton

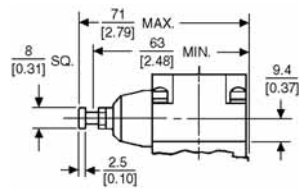

Roller

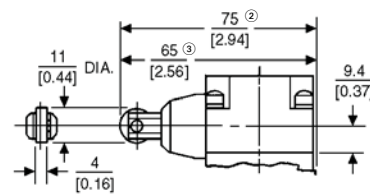

Maintained Pushbutton

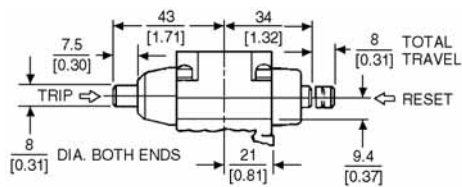

Top Push Operators

Pushbutton

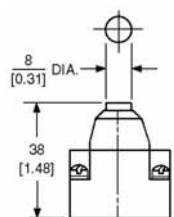

Adjustable Pushbutton

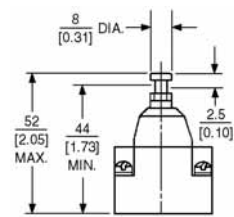

Roller

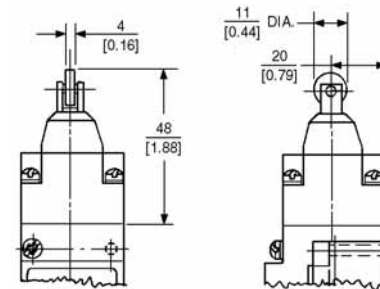

Wobble Operators

See Operators on **Page V8-T2-80**.

Notes

- Can accommodate both U.S., 1.16 (29.4) x 2.34 (59.5) and DIN, 1.18 (30.0) x 3.26 (60.0), mounting dimensions.
- For E50DS4.
- For E50DS3.

Accessories

Approximate Dimensions in mm [in]

Adapter Plates

E50KH1M

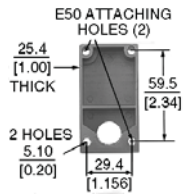

E50KH7

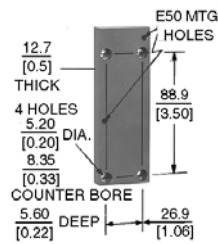

E50KH4

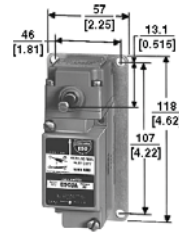

E50KH5

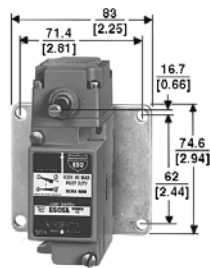

E50KH2

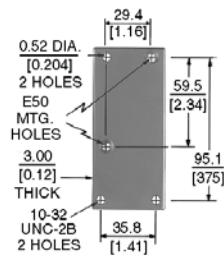

E50KH10

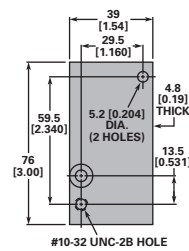

Adjustable Mounting Plate

E50KH3

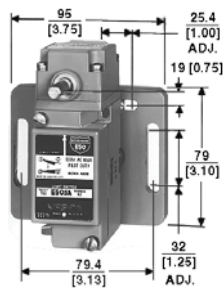

Operators



Contents

Description

Page

| | |
|-----------------------|-----------------|
| Operators | |
| Product Selection | |
| Roller Type Operators | V8-T2-81 |
| Rod Type Operators | V8-T2-83 |
| Wobble Type Operators | V8-T2-84 |
| Dimensions | V8-T2-84 |



Operators

Product Description

The Operators presented here are used with Eaton's E50 Plug-In and 6P+ limit switches, as well as our 10316 rotary type limit switches. A wide variety of styles and sizes are available to provide optimum performance for nearly any application.

Features

- Wide variety of operator types for rotary and wobble style limit switches
- Rollers and rods available in metal and nonmetal contact surfaces

⚠ DANGER

THIS SENSOR IS NOT A SAFETY DEVICE AND IS NOT INTENDED TO BE USED AS A SAFETY DEVICE. This sensor is designed only to detect and read certain data in an electronic manner and perform no use apart from that, specifically no safety-related use. This sensor product does not include self-checking redundant circuitry, and the failure of this sensor product could cause either an energized or de-energized output condition, which could result in death, serious bodily injury, or property damage.

For the most current information on this product, visit our Web site: www.eaton.com

For Customer Service in the U.S. call 1-877-ETN CARE (386-2273), in Canada call 1-800-268-3578. For Application Assistance in the U.S. and Canada call 1-800-426-9184.

Product Selection

Roller Type Operators

For rotary head switches: E50 Plug-In, E50 6P+, and 10316.

Note: Only operators with Nylatron rods or rollers should be used with explosion-proof limit switches.

Operators—Roller Type

| Roller Type | Minimum Required Return Torque ^① | Approximate Dimensions in Inches (mm) | | | | | | Catalog Number | |
|---|---|---------------------------------------|----------------------|-------------------|-------------|------------|-------------|----------------|-----------------|
| | | A Lever Length ^② | B Roller Diameter | C Roller Width | D | E | F | | |
| E50KL200 | Standard Roller (Stainless Steel) | | | | | | | | |
|  | Metal | 0.62 in-oz | 0.88 (22.2) | 0.75 (19.0) | 0.32 (8.1) | 0.31 (7.9) | 0.20 (5.1) | 0.24 (6.1) | E50KL39 |
| | Metal | 0.95 in-oz | 1.38 (34.9) | 0.75 (19.0) | 0.32 (8.1) | 0.34 (8.6) | 0.13 (3.3) | 0.17 (4.3) | E50KL40 |
| | Ball bearing | 0.77 in-oz | 1.50 (38.1) | 0.69 (17.5) | 0.25 (6.4) | 0.34 (8.6) | 0.05 (1.3) | 0.11 (2.8) | E50KL531 |
| | Nylatron | 0.53 in-oz | 1.50 (38.1) | 0.75 (19.0) | 0.32 (8.1) | 0.34 (8.6) | 0.13 (3.3) | 0.17 (4.3) | E50KL200 |
| E50KL355 | Metal | 1.10 in-oz | 1.50 (38.1) | 0.75 (19.0) | 0.32 (8.1) | 0.34 (8.6) | 0.13 (3.3) | 0.17 (4.3) | E50KL355 |
|  | Nylatron | 0.96 in-oz | 1.50 (38.1) | 0.75 (19.0) | 1.00 (25.4) | 0.34 (8.6) | 0.83 (21.1) | 0.83 (21.1) | E50KL377 |
| | Without roller | 0.32 in-oz | 1.50 (38.1) | — | — | 0.34 (8.6) | — | — | E50KL32 |
| | Ball bearing | 1.10 in-oz | 2.00 (50.8) | 0.69 (17.5) | 0.25 (6.4) | 0.34 (8.6) | 0.05 (1.3) | 0.11 (2.8) | E50KL552 |
| | Nylatron | 0.71 in-oz | 2.00 (50.8) | 0.75 (19.0) | 0.32 (8.1) | 0.34 (8.6) | 0.13 (3.3) | 0.17 (4.3) | E50KL546 |
| E50KL377 | Metal | 1.50 in-oz | 2.00 (50.8) | 0.75 (19.0) | 0.32 (8.1) | 0.34 (8.6) | 0.13 (3.3) | 0.17 (4.3) | E50KL549 |
|  | Nylatron | 1.45 in-oz | 2.00 (50.8) | 0.75 (19.0) | 1.00 (25.4) | 0.34 (8.6) | 0.83 (21.1) | 0.83 (21.1) | E50KL572 |
| | Ball bearing | 1.50 in-oz | 2.50 (63.5) | 0.69 (17.5) | 0.25 (6.4) | 0.34 (8.6) | 0.05 (1.3) | 0.11 (2.8) | E50KL553 |
| | Nylatron | 1.00 in-oz | 2.50 (63.5) | 0.75 (19.0) | 0.32 (8.1) | 0.34 (8.6) | 0.13 (3.3) | 0.17 (4.3) | E50KL547 |
| | Metal | 2.00 in-oz | 2.50 (63.5) | 0.75 (19.0) | 0.32 (8.1) | 0.34 (8.6) | 0.13 (3.3) | 0.17 (4.3) | E50KL550 |
| E50KL554 | Nylatron | 1.80 in-oz | 2.50 (63.5) | 0.75 (19.0) | 1.00 (25.4) | 0.34 (8.6) | 0.83 (21.1) | 0.83 (21.1) | E50KL573 |
|  | Nylatron | 1.40 in-oz | 2.50 (63.5) | 1.50 (38.1) | 0.28 (7.1) | 0.34 (8.6) | 0.11 (2.8) | 0.17 (4.3) | E50KL575 |
| | Ball bearing | 1.80 in-oz | 3.00 (76.2) | 0.69 (17.5) | 0.25 (6.4) | 0.34 (8.6) | 0.05 (1.3) | 0.11 (2.8) | E50KL554 |
| | Nylatron | 1.30 in-oz | 3.00 (76.2) | 0.75 (19.0) | 0.32 (8.1) | 0.34 (8.6) | 0.13 (3.3) | 0.17 (4.3) | E50KL548 |
| | Metal | 2.50 in-oz | 3.00 (76.2) | 0.75 (19.0) | 0.32 (8.1) | 0.34 (8.6) | 0.13 (3.3) | 0.17 (4.3) | E50KL551 |
| | Nylatron | 2.30 in-oz | 3.00 (76.2) | 0.75 (19.0) | 1.00 (25.4) | 0.34 (8.6) | 0.83 (21.1) | 0.83 (21.1) | E50KL574 |
| | Nylatron | 1.80 in-oz | 3.00 (76.2) | 1.50 (38.1) | 0.28 (7.1) | 0.34 (8.6) | 0.11 (2.8) | 0.17 (4.3) | E50KL576 |
| E50KL580 | Dimensions, see Page V8-T2-84. | | | | | | | | |
|  | Roller On Reverse Side (Stainless Steel) | | | | | | | | |
| | Ball bearing | 0.77 in-oz | 1.50 (38.1) | 0.69 (17.5) | 0.25 (6.4) | 0.34 (8.6) | 0.18 (4.6) | 0.24 (6.1) | E50KL580 |
| | Nylatron | 0.53 in-oz | 1.50 (38.1) | 0.75 (19.0) | 0.32 (8.1) | 0.34 (8.6) | 0.27 (6.9) | 0.31 (7.9) | E50KL310 |
| | Metal | 1.10 in-oz | 1.50 (38.1) | 0.75 (19.0) | 0.32 (8.1) | 0.34 (8.6) | 0.27 (6.9) | 0.31 (7.9) | E50KL579 |
| E50KL24 | Nylatron | 0.96 in-oz | 1.50 (38.1) | 1.50 (38.1) | 0.28 (7.1) | 0.34 (8.6) | 0.23 (5.8) | 0.31 (7.9) | E50KL536 |
|  | Offset Inboard Roller (Stainless Steel) | | | | | | | | |
| | Nylatron | 0.65 in-oz | 1.50 (38.1) | 0.75 (19.0) | 0.32 (8.1) | 0.03 (0.8) | — | — | E50KL24 |
| | Metal | 1.20 in-oz | 1.50 (38.1) | 0.75 (19.0) | 0.32 (8.1) | 0.03 (0.8) | — | — | E50KL25 |
| E50KL27 | Ball bearing | 0.90 in-oz | 1.50 (38.1) | 0.69 (17.5) | 0.25 (6.4) | 0.04 (1.0) | — | — | E50KL26 |
|  | Offset Outboard Roller (Stainless Steel) | | | | | | | | |
| | Nylatron | 0.65 in-oz | 1.50 (38.1) | 0.75 (19.0) | 0.32 (8.1) | 0.03 (0.8) | — | — | E50KL27 |
| | Metal | 1.20 in-oz | 1.50 (38.1) | 0.75 (19.0) | 0.32 (8.1) | 0.03 (0.8) | — | — | E50KL28 |
| | Ball bearing | 0.90 in-oz | 1.50 (38.1) | 0.69 (17.5) | 0.25 (6.4) | 0.04 (1.0) | — | — | E50KL29 |
| | Nylatron | 1.10 in-oz | 1.50 (38.1) | 0.75 (19.0) | 1.00 (25.4) | — | — | — | E50KL30 |

Dimensions, see Page V8-T2-85.

Notes

^① **Caution:** When selecting lever, the minimum required return torque of lever should not exceed minimum return force available in operating head as given in operating head specifications.

^② Length from the operating shaft axis to the roller axis (or to the tip for non-roller operators).

Note: Only operators with Nylatron rods or rollers should be used with explosion-proof limit switches.

Operators—Roller Type, continued

| Roller Type | Minimum Required Return Torque ^① | Approximate Dimensions in Inches (mm) | | | | | | Catalog Number |
|--|---|--|-------------------|----------------|-------------|-------------|------------|--------------------------|
| | | A Lever Length ^② | B Roller Diameter | C Roller Width | D | E | F | |
| E50KL532 | | | | | | | | |
| Bantam Lever | | | | | | | | |
| Metal | 0.45 in-oz | 0.69 (17.5) | 0.85 (22.0) | 0.18 (4.6) | — | — | — | E50KL532 |
| E50KL340 | | | | | | | | |
| Precision Adjustment | | | | | | | | |
| Nylatron | 0.65 in-oz | 0.69 (17.5) | 0.75 (19.0) | 0.32 (8.1) | 0.48 (12.2) | 0.24 (6.1) | 0.28 (7.1) | E50KL340 |
| Metal | 1.20 in-oz | Roller length: 1.50 (38.1) ^③ | 0.75 (19.0) | 0.32 (8.1) | 0.48 (12.2) | 0.24 (6.1) | 0.28 (7.1) | E50KL465 |
| Ball bearing | 0.90 in-oz | | 0.69 (17.5) | 0.25 (6.4) | 0.48 (12.2) | 0.16 (4.1) | 0.22 (5.6) | E50KL535 |
| E50KL201 | | | | | | | | |
| Dimensions, see Page V8-T2-85. | | | | | | | | |
| Adjustable Roller (Stainless Steel) | | | | | | | | |
| Ball bearing | 2.50 in-oz ^④ | 1.0 (25.4) to 3.75 (95.2) ^⑤ | 0.69 (17.5) | 0.25 (6.4) | 0.23 (5.8) | 0.30 (7.6) | — | E50KL539 |
| Nylatron | 1.90 in-oz ^④ | | 0.75 (19.0) | 0.32 (8.1) | 0.29 (7.4) | 0.33 (8.4) | — | E50KL201 |
| | | | 0.75 (19.0) | 0.32 (8.1) | 0.29 (7.4) | 0.33 (8.4) | — | E50KL201SPL ^⑥ |
| E50KL537 | | | | | | | | |
| Metal | 3.40 in-oz ^④ | | 0.75 (19.0) | 0.32 (8.1) | 0.29 (7.4) | 0.33 (8.4) | — | E50KL538 |
| Nylatron | 1.90 in-oz ^④ | | 0.75 (19.0) | 0.50 (12.7) | 0.46 (11.6) | 0.48 (12.2) | — | E50KL599 |
| Nylatron | 3.10 in-oz ^④ | | 0.75 (19.0) | 1.00 (25.4) | 0.90 (22.9) | 0.95 (24.1) | — | E50KL537 |
| Large Nylatron | 4.50 in-oz ^④ | 0.5 (12.7) to 3.25 (82.6) | 4.00 (102.0) | 0.11 (2.8) | 0.11 (2.8) | 0.19 (4.8) | — | E50KL598 |
| Without roller | 1.20 in-oz ^④ | 0.5 (12.7) to 3.75 (95.2) | — | — | — | — | — | E50KL31 |
| Nylatron | 2.50 in-oz ^④ | 1.63 (41.3) to 3.75 (95.2) ^⑥ | 1.50 (38.1) | 0.29 (7.4) | 0.26 (6.6) | 0.32 (8.1) | — | E50KL443 |

Dimensions, see Page V8-T2-86.

Operators—Roller Type, continued

| Roller Type | Minimum Required Return Torque ^① | Approximate Dimensions in Inches (mm) | | | | | | Catalog Number | |
|--|---|---------------------------------------|-------------------|----------------|-------------|-------------|-------------|----------------|----------|
| | | A Lever Length ^② | B Roller Diameter | C Roller Width | D | E | F | | G |
| E50KL545 | | | | | | | | | |
| Fork Lever—Both Rollers on One Side | | | | | | | | | |
| Ball bearing | — | 1.50 (38.1) | 0.69 (17.5) | 0.25 (6.4) | 0.08 (2.0) | 0.14 (3.6) | — | E50KL545 | |
| Nylatron | — | | 0.75 (19.0) | 0.32 (8.1) | 0.16 (4.1) | 0.20 (5.1) | — | E50KL204 | |
| Metal | — | | 0.75 (19.0) | 0.32 (8.1) | 0.16 (4.1) | 0.20 (5.1) | — | E50KL544 | |
| Nylatron | — | | 0.75 (19.0) | 1.00 (25.4) | 0.84 (21.3) | 0.88 (22.4) | — | E50KL543 | |
| E50KL542 | | | | | | | | | |
| Fork Lever—One Roller Outside, One Inside | | | | | | | | | |
| Ball bearing | — | 1.50 (38.1) | 0.69 (17.5) | 0.25 (6.4) | 0.08 (2.0) | 0.14 (3.6) | 0.64 (16.3) | 0.70 (17.8) | E50KL542 |
| Nylatron | — | | 0.75 (19.0) | 0.32 (8.1) | 0.16 (4.1) | 0.20 (5.1) | 0.73 (18.5) | 0.77 (19.6) | E50KL203 |
| Metal | — | | 0.75 (19.0) | 0.32 (8.1) | 0.16 (4.1) | 0.20 (5.1) | 0.73 (18.5) | 0.77 (19.6) | E50KL541 |

Dimensions, see Page V8-T2-86.

Notes



- ① **Caution:** When selecting lever, the minimum required return torque of lever should not exceed minimum return force available in operating head as given in operating head specifications.
- ② Length from the operating shaft axis to the roller axis (or to the tip for non-roller operators).
- ③ Maximum length dimension between operating shaft axis to roller axis for comparison. Precision adjustable to lesser dimensions.
- ④ Applies when lever is extended to the maximum dimension.
- ⑤ By reassembling lever, minimum length can be reduced another 0.5 in (12.7 mm).
- ⑥ High-grade stainless steel.

Rod Type Operators





For rotary head switches: E50 Plug-In, E50 6P+, and 10316.

Note: Only operators with Nylatron rods or rollers should be used with explosion-proof limit switches.

Operators—Rod Type

| Rod Type | Minimum Required Return Torque ^① | Approximate Dimensions in Inches (mm) | | | Catalog Number |
|---|---|---------------------------------------|----------------|---|----------------|
| | | A Rod Length (Maximum) ^② | B Rod Diameter | | |
| Adjustable Rod | | | | | |
|  Nylon/Metal | Nylon | 0.40 in-oz ^③ | 5.50 (140.0) | 0.19 (4.8) | E50KL399 |
| | Metal | 0.92 in-oz ^③ | | 0.12 (3.2) | E50KL202 |
| | Metal | 2.20 in-oz ^③ | 8.75 (222.0) | Rod size (square): 0.12 (3.2) x 0.12 (3.2) | E50KL581 |
|  Metal/Steel | Stainless steel | 7.00 in-oz ^③ | 9.00 (229.0) | 0.19 (4.8) | E50KL220 |
| | Bendable steel | 5.00 in-oz ^③ | 12.00 (305.0) | 0.12 (3.2) | E50KL226 |
| Clamps for Adjustable Rods (Rod not included) | | | | | |
| Clamp for ... | | | | | |
| 0.19 (4.8) diameter rods | | | | | E50KL35 |
| 0.12 (3.2) diameter rods | | | | | E50KL36 |
| 0.25 (6.4) diameter rods | | | | | E50KL41 |
| Dimensions, see Page V8-T2-87. | | | | | |

Operators—Rod Type, continued

| Rod Type | Minimum Required Return Torque ^① | Approximate Dimensions in Inches (mm) | | | | Catalog Number | |
|--|---|---------------------------------------|----------------|---|-------------|----------------|---------|
| | | A Rod Length ^② | B Rod Diameter | C | D | | |
| Spring Rod | | | | | | | |
|  Nylon/Steel | Nylon | 3.50 in-oz | — | — | — | E50KL556 | |
| | Stainless steel | 2.80 in-oz | — | — | — | E50KL421 | |
| Adjustable Wire | | | | | | | |
|  Nylon Covered Wire | Nylon covered wire | 1.50 in-oz ^③ | — | — | — | E50KL533 | |
| Adjustable Wide Roller Lever | | | | | | | |
|  Nylatron | Nylatron | 4.50 in-oz ^③ | — | — | — | E50KL37 | |
| Nylatron Loop | | | | | | | |
|  Nylatron | Nylatron | 0.40 in-oz | 6.00 (152.0) | ∅: 0.158 (4.0) | — | E50KL142 | |
| Eye Bolt | | | | | | | |
|  Zinc-Plated Steel | Zinc-plated steel | 0.53 in-oz | 150.00 (38.1) | ∅: 0.1875 (4.8) Loop ID: 0.375 (9.5) | 0.52 (13.1) | 0.24 (8.6) | E50KL33 |

Dimensions, see Page V8-T2-87.

Notes



- ① **Caution:** When selecting lever, the minimum required return torque of lever should not exceed minimum return force available in operating head as given in operating head specifications.
- ② Length from the operating shaft axis to tip.
- ③ Applies when lever is extended to the maximum dimension.

Wobble Type Operators

For E50DW1 and E50DWZ Operator Heads on E50 Plug-In and E50 6P+ Switches.

Note: Only operators with Nylatron rods or rollers should be used with explosion-proof limit switches.

Operators—Wobble Type

| Wobble Type | Catalog Number |
|--|-------------------------------|
|  E50KW2 | Nylon Rod E50KW2 |
|  E50KW3 | Stainless Steel Rod E50KW3 |
|  E50KW4 | Coil Spring E50KW4 |

Dimensions, see Page V8-T2-88.

Dimensions

Roller Type Operators

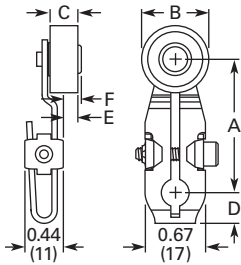

Standard Roller

Approximate Dimensions in Inches (mm)

| Catalog Number | A Lever Length ^① | B Roller Diameter | C Roller Width | D | E | F |
|----------------|--------------------------------|----------------------|-------------------|------------|-------------|-------------|
| E50KL39 | 0.88 (22.2) | 0.75 (19.0) | 0.32 (8.1) | 0.31 (7.9) | 0.20 (5.1) | 0.24 (6.1) |
| E50KL40 | 1.38 (34.9) | 0.75 (19.0) | 0.32 (8.1) | 0.34 (8.6) | 0.13 (3.3) | 0.17 (4.3) |
| E50KL531 | 1.50 (38.1) | 0.69 (17.5) | 0.25 (6.4) | 0.34 (8.6) | 0.05 (1.3) | 0.11 (2.8) |
| E50KL200 | 1.50 (38.1) | 0.75 (19.0) | 0.32 (8.1) | 0.34 (8.6) | 0.13 (3.3) | 0.17 (4.3) |
| E50KL355 | 1.50 (38.1) | 0.75 (19.0) | 0.32 (8.1) | 0.34 (8.6) | 0.13 (3.3) | 0.17 (4.3) |
| E50KL377 | 1.50 (38.1) | 0.75 (19.0) | 1.00 (25.4) | 0.34 (8.6) | 0.83 (21.1) | 0.83 (21.1) |
| E50KL32 | 1.50 (38.1) | — | — | 0.34 (8.6) | — | — |
| E50KL552 | 2.00 (50.8) | 0.69 (17.5) | 0.25 (6.4) | 0.34 (8.6) | 0.05 (1.3) | 0.11 (2.8) |
| E50KL546 | 2.00 (50.8) | 0.75 (19.0) | 0.32 (8.1) | 0.34 (8.6) | 0.13 (3.3) | 0.17 (4.3) |
| E50KL549 | 2.00 (50.8) | 0.75 (19.0) | 0.32 (8.1) | 0.34 (8.6) | 0.13 (3.3) | 0.17 (4.3) |
| E50KL572 | 2.00 (50.8) | 0.75 (19.0) | 1.00 (25.4) | 0.34 (8.6) | 0.83 (21.1) | 0.83 (21.1) |
| E50KL553 | 2.50 (63.5) | 0.69 (17.5) | 0.25 (6.4) | 0.34 (8.6) | 0.05 (1.3) | 0.11 (2.8) |
| E50KL547 | 2.50 (63.5) | 0.75 (19.0) | 0.32 (8.1) | 0.34 (8.6) | 0.13 (3.3) | 0.17 (4.3) |
| E50KL550 | 2.50 (63.5) | 0.75 (19.0) | 0.32 (8.1) | 0.34 (8.6) | 0.13 (3.3) | 0.17 (4.3) |
| E50KL573 | 2.50 (63.5) | 0.75 (19.0) | 1.00 (25.4) | 0.34 (8.6) | 0.83 (21.1) | 0.83 (21.1) |
| E50KL575 | 2.50 (63.5) | 1.50 (38.1) | 0.28 (7.1) | 0.34 (8.6) | 0.11 (2.8) | 0.17 (4.3) |
| E50KL554 | 3.00 (76.2) | 0.69 (17.5) | 0.25 (6.4) | 0.34 (8.6) | 0.05 (1.3) | 0.11 (2.8) |
| E50KL548 | 3.00 (76.2) | 0.75 (19.0) | 0.32 (8.1) | 0.34 (8.6) | 0.13 (3.3) | 0.17 (4.3) |
| E50KL551 | 3.00 (76.2) | 0.75 (19.0) | 0.32 (8.1) | 0.34 (8.6) | 0.13 (3.3) | 0.17 (4.3) |
| E50KL574 | 3.00 (76.2) | 0.75 (19.0) | 1.00 (25.4) | 0.34 (8.6) | 0.83 (21.1) | 0.83 (21.1) |
| E50KL576 | 3.00 (76.2) | 1.50 (38.1) | 0.28 (7.1) | 0.34 (8.6) | 0.11 (2.8) | 0.17 (4.3) |

Note

^① Length from the operating shaft axis to the roller axis (or to the tip for non-roller operators).

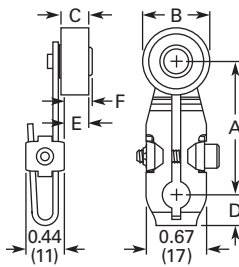

Roller on Reverse Side

Approximate Dimensions in Inches (mm)

| Catalog Number | A Lever Length ^① | B Roller Diameter | C Roller Width | D | E | F |
|-----------------|--------------------------------|----------------------|-------------------|------------|------------|------------|
| E50KL580 | 1.50 (38.1) | 0.69 (17.5) | 0.25 (6.4) | 0.34 (8.6) | 0.18 (4.6) | 0.24 (6.1) |
| E50KL310 | 1.50 (38.1) | 0.75 (19.0) | 0.32 (8.1) | 0.34 (8.6) | 0.27 (6.9) | 0.31 (7.9) |
| E50KL579 | 1.50 (38.1) | 0.75 (19.0) | 0.32 (8.1) | 0.34 (8.6) | 0.27 (6.9) | 0.31 (7.9) |
| E50KL536 | 1.50 (38.1) | 1.50 (38.1) | 0.28 (7.1) | 0.34 (8.6) | 0.23 (5.8) | 0.31 (7.9) |

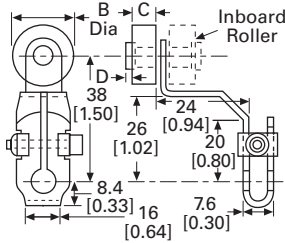

Offset Roller

Approximate Dimensions in mm [in]

| Catalog Number | A Lever Length ^① | B Roller Diameter | C Roller Width | D |
|-----------------|--------------------------------|----------------------|-------------------|------------|
| Inboard | | | | |
| E50KL24 | 38.1 [1.50] | 19.0 [0.75] | 8.1 [0.32] | 0.8 [0.03] |
| E50KL25 | 38.1 [1.50] | 19.0 [0.75] | 8.1 [0.32] | 0.8 [0.03] |
| E50KL26 | 38.1 [1.50] | 17.5 [0.69] | 6.4 [0.25] | 1.0 [0.04] |
| Outboard | | | | |
| E50KL27 | 38.1 [1.50] | 19.0 [0.75] | 8.1 [0.32] | 0.8 [0.03] |
| E50KL28 | 38.1 [1.50] | 19.0 [0.75] | 8.1 [0.32] | 0.8 [0.03] |
| E50KL29 | 38.1 [1.50] | 17.5 [0.69] | 6.4 [0.25] | 1.0 [0.04] |
| E50KL30 | 38.1 [1.50] | 19.0 [0.75] | 25.4 [1.00] | — |

Bantam Lever

Approximate Dimensions in mm [in]

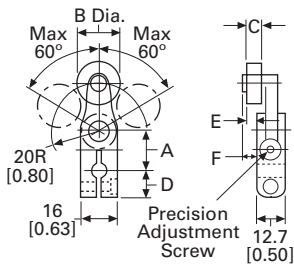
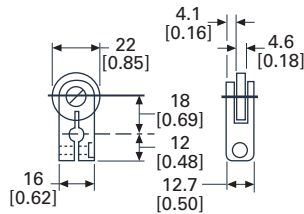

Precision Adjustment

Approximate Dimensions in mm [in]

| Catalog Number | A Lever Length ^① | B Roller Diameter | C Roller Width | D | E | F |
|-----------------|--|----------------------|-------------------|-------------|------------|------------|
| E50KL340 | 17.5 [0.69] | 19.0 [0.75] | 8.1 [0.32] | 12.2 [0.48] | 6.1 [0.24] | 7.1 [0.28] |
| E50KL465 | Roller length: 38.1 [1.50] ^② | 19.0 [0.75] | 8.1 [0.32] | 12.2 [0.48] | 6.1 [0.24] | 7.1 [0.28] |
| E50KL535 | | 17.5 [0.69] | 6.4 [0.25] | 12.2 [0.48] | 4.1 [0.16] | 5.6 [0.22] |

Notes

- ① Length from the operating shaft axis to the roller axis (or to the tip for non-roller operators).
- ② Maximum length dimension between operating shaft axis to the roller axis for comparison. Precision adjustable to lesser dimensions.

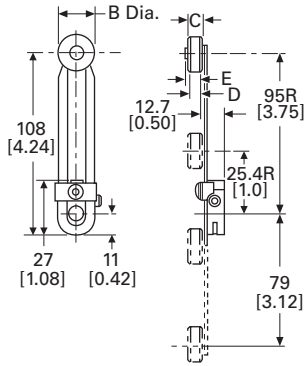

Adjustable Roller

Approximate Dimensions in mm [in]

| Catalog Number | A Lever Length ① | B Roller Diameter | C Roller Width | D | E |
|----------------------|---------------------------------|----------------------|-------------------|-------------|-------------|
| E50KL539 | 25.4 [1.0] to 95.2 [3.75] ② | 17.5 [0.69] | 6.4 [0.25] | 5.8 [0.23] | 7.6 [0.30] |
| E50KL201 | | 19.0 [0.75] | 8.1 [0.32] | 7.4 [0.29] | 8.4 [0.33] |
| E50KL201SPL ③ | | 19.0 [0.75] | 8.1 [0.32] | 7.4 [0.29] | 8.4 [0.33] |
| E50KL538 | | 19.0 [0.75] | 8.1 [0.32] | 7.4 [0.29] | 8.4 [0.33] |
| E50KL599 | | 19.0 [0.75] | 12.7 [0.50] | 11.6 [0.46] | 12.2 [0.48] |
| E50KL537 | | 19.0 [0.75] | 25.4 [1.00] | 22.9 [0.90] | 24.1 [0.95] |
| E50KL598 | 12.7 [0.50] to 82.6 [3.25] | 102.0 [4.00] | 2.8 [0.11] | 4.8 [0.19] | 24.1 [0.95] |
| E50KL31 | 12.7 [0.50] to 95.2 [3.75] | — | — | — | — |
| E50KL443 | 41.3 [1.63] to 95.2 [3.75] ② | 38.1 [1.50] | 7.4 [0.29] | 6.6 [0.26] | 8.1 [0.32] |

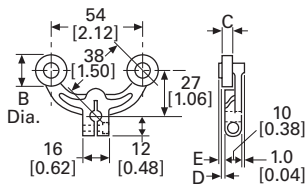

Fork Lever—Both Rollers on One Side

Approximate Dimensions in mm [in]

| Catalog Number | A Lever Length ① | B Roller Diameter | C Roller Width | D | E |
|-----------------|---------------------|----------------------|-------------------|-------------|-------------|
| E50KL545 | 38.1 [1.50] | 17.5 [0.69] | 6.4 [0.25] | 2.0 [0.08] | 3.6 [0.14] |
| E50KL204 | 38.1 [1.50] | 19.0 [0.75] | 8.1 [0.32] | 4.1 [0.16] | 5.1 [0.20] |
| E50KL544 | 38.1 [1.50] | 19.0 [0.75] | 8.1 [0.32] | 4.1 [0.16] | 5.1 [0.20] |
| E50KL543 | 38.1 [1.50] | 19.0 [0.75] | 25.4 [1.00] | 21.3 [0.84] | 22.4 [0.88] |

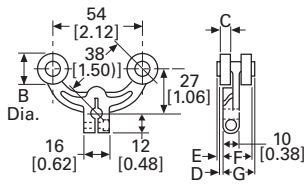

Fork Lever—One Roller Outside, One Inside

Approximate Dimensions in mm [in]

| Catalog Number | A Lever Length ① | B Roller Diameter | C Roller Width | D | E | F | G |
|-----------------|---------------------|----------------------|-------------------|------------|------------|-------------|-------------|
| E50KL542 | 38.1 [1.50] | 17.5 [0.69] | 6.4 [0.25] | 2.0 [0.08] | 3.6 [0.14] | 16.3 [0.64] | 17.8 [0.70] |
| E50KL203 | 38.1 [1.50] | 19.0 [0.75] | 8.1 [0.32] | 4.1 [0.16] | 5.1 [0.20] | 18.5 [0.73] | 19.6 [0.77] |
| E50KL541 | 38.1 [1.50] | 19.0 [0.75] | 8.1 [0.32] | 4.1 [0.16] | 5.1 [0.20] | 18.5 [0.73] | 19.6 [0.77] |

Notes

- ① Length from the operating shaft axis to the roller axis (or to the tip for non-roller operators).
- ② By reassembling lever, minimum length can be reduced another 12.7 mm [0.5 in].
- ③ High-grade stainless steel.

Approximate Dimensions in Inches or mm [in]

Rod Type Operators

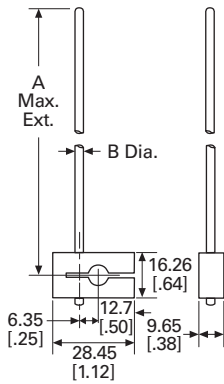

Adjustable Rod

| Catalog Number | A Rod Length ① | B Rod Diameter |
|----------------|----------------|---|
| E50KL399 | 140.0 [5.50] | 4.8 [0.19] |
| E50KL202 | | 3.2 [0.12] |
| E50KL581 | 222.0 [8.75] | Rod size (square): 3.2 [0.12] x 3.2 [0.12] |
| E50KL220 | 229.0 [9.00] | 4.8 [0.19] |
| E50KL226 | 305.0 [12.00] | 3.2 [0.12] |

Spring Rod – E50KL556

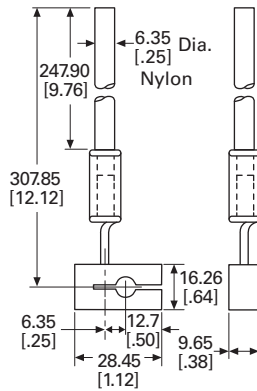

Spring Rod – E50KL421

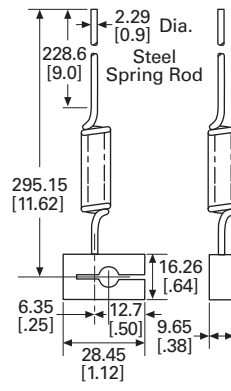

Adjustable Wire

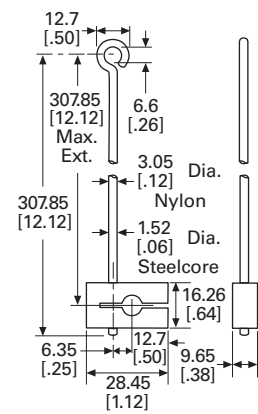

Adjustable Wide Roller Lever

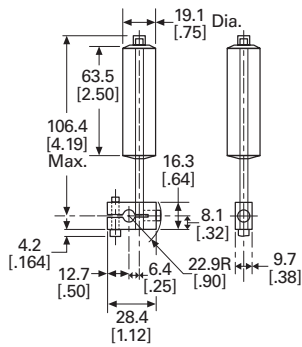

Nylatron Loop – E50KL142

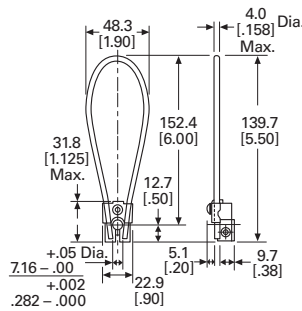

Eye Bolt

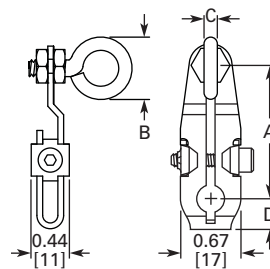

| Catalog Number | A Rod Length ② | B Rod Diameter | C Rod Width | D |
|----------------|----------------|----------------|----------------------|------------|
| E50KL33 | 38.1 [1.50] | 4.8 [0.1875] | 13.1 [0.52] | 8.6 [0.34] |
| | | | Loop ID: 9.5 [0.375] | |

Notes

- ① Applies when lever is extended to the maximum dimension.
- ② Length from the operating shaft axis to tip.

2.8

Limit Switches

Operators

Wobble Type Operators

Nylon Rod

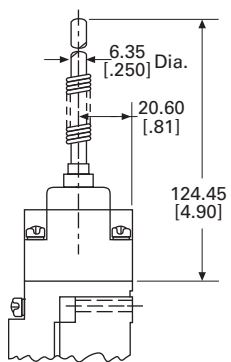

Stainless Steel Rod

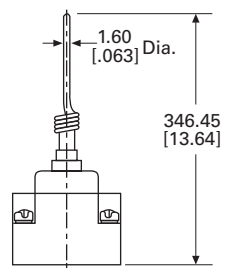

Coil Spring

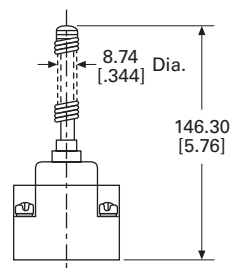

Non Plug-In Switches



Non Plug-In Switches

Product Description

10316 Type L non plug-in limit switches by Eaton's electrical sector are sold as complete assembled devices only with a wide array of operating head configurations. All switches are single-pole 1NO-1NC.

Features

- Side and top rotary, side and top push or wobble operation
- CW, CCW or CW and CCW operating modes are field convertible
- Double break-make snap action contacts, same polarity each pole
- Captive saddle clamp terminals accept up to #12 wire
- Head can be mounted in any of four discrete positions, intervals of 90°

Contents

Description

| Description | Page |
|-----------------------------------|----------|
| Non Plug-In Switches | |
| Product Selection | V8-T2-90 |
| Technical Data and Specifications | V8-T2-91 |
| Dimensions | V8-T2-91 |

Standards and Certifications

- UL Listed
- CSA Certified



⚠ DANGER

THIS SENSOR IS NOT A SAFETY DEVICE AND IS NOT INTENDED TO BE USED AS A SAFETY DEVICE. This sensor is designed only to detect and read certain data in an electronic manner and perform no use apart from that, specifically no safety-related use. This sensor product does not include self-checking redundant circuitry, and the failure of this sensor product could cause either an energized or de-energized output condition, which could result in death, serious bodily injury, or property damage.

For the most current information on this product, visit our Web site: www.eaton.com

For Customer Service in the U.S. call 1-877-ETN CARE (386-2273), in Canada call 1-800-268-3578.

For Application Assistance in the U.S. and Canada call 1-800-426-9184.

Product Selection

2

Complete Assembled Switches Single-Pole 1NO-1NC

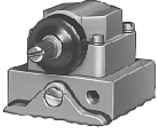
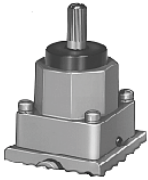
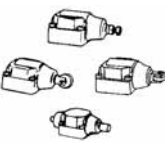
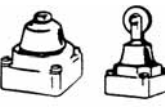
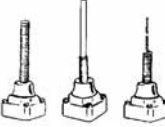
| Operating Characteristics | Operating Data—Nominal | | | Force to Operate Contacts | Minimum Return Force | Catalog Number |
|---|-------------------------------|--------------------------|------------------|---------------------------|----------------------|------------------|
| | Travel to Operate Contacts | Travel to Reset Contacts | Total Travel | | | |
| Side Rotary Operated | Side Rotary Operated ① | | | | | |
|  Standard | 10° | 4° | 50° | 3 in-lbs | 4.5 in-oz | 10316H187 |
| Top Rotary Operated | Top Rotary Operated ① | | | | | |
|  Clockwise | 20° | 12° | 140° | 1.1 in-lbs | 3 in-oz | 10316H700 |
| Counterclockwise | 20° | 12° | 140° | 1.1 in-lbs | 3 in-oz | 10316H701 |
| Side Push Operated | Side Push Operated | | | | | |
|  Adjustable pushbutton | 0.07 in (1.8 mm) | 0.03 in (0.8 mm) | 0.29 in (7.4 mm) | 4 lbs | 8 oz | 10316H621 |
| Vertical roller— 0.44 in (11.2 mm) dia. | 0.07 in (1.8 mm) | 0.03 in (0.8 mm) | 0.29 in (7.4 mm) | 4 lbs | 8 oz | 10316H284 |
| Horizontal roller— 0.44 in (11.2 mm) dia. | 0.07 in (1.8 mm) | 0.03 in (0.8 mm) | 0.29 in (7.4 mm) | 4 lbs | 8 oz | 10316H285 |
| Top Push Operated | Top Push Operated | | | | | |
|  Pushbutton | 0.04 in (1.0 mm) | 0.02 in (0.5 mm) | 0.28 in (7.1 mm) | 4 lbs | 8 oz | 10316H281 |
| Roller—0.44 in (11.2 mm) dia. | 0.04 in (1.0 mm) | 0.02 in (0.5 mm) | 0.28 in (7.1 mm) | 4 lbs | 8 oz | 10316H283 |
| Roller—0.75 in (19.1 mm) dia. | 0.04 in (1.0 mm) | 0.02 in (0.5 mm) | 0.28 in (7.1 mm) | 4 lbs | 8 oz | 10316H577 |
| Wobble Operated | Wobble Operated ② | | | | | |
|  Spring | 10° | 6° | 15° | 1 in-lb | 2.4 in-oz | 10316H299 |
| Nylon rod | 10° | 6° | 15° | 2 in-lbs | 2.4 in-oz | 10316H296 |
| Wire | 10° | 6° | 15° | 2 in-lbs | 2.4 in-oz | 10316H484 |
| Cat whisker | 15° | 5° | 30° | 0.63 in-lb | 1.7 in-oz | 10316H341 |

Notes① For operating levers, see **Page V8-T2-80**.② For wobble operators, see **Page V8-T2-80**.

Technical Data and Specifications

Non Plug-In Switches

| Description | Specification |
|-------------------------------|--|
| Contact rating | NEMA A600, R300 double break-make snap action contacts |
| Electrical life | 500,000 operations minimum |
| Mechanical life | 5,000,000 operations minimum at full load |
| Conduit entrance | 0.5 in (12.7 mm) NPT |
| Material of construction | Zinc die cast |
| Enclosure rating | NEMA 1, 4, 13 |
| Ambient operating temperature | -20° to 200°F (-29° to 93°C) ① |
| Approximate shipping weight | 2 lbs |

Electrical Data—Maximum Contact Ratings per Pole ②

| AC Volts | Current, Amperes | | Cont. Thermal Ratings | Volts, Amperes | | DC Volts | DC Current, Ampere |
|------------------------|------------------|-------|-----------------------|----------------|-------|----------|--------------------|
| | Make | Break | | Make | Break | | |
| NEMA A600, R300 Rating | | | | | | | |
| 120 | 60 | 6 | 10 | 7200 | 720 | 125 | 0.22 |
| 240 | 30 | 3 | 10 | 7200 | 720 | 250 | 0.11 |
| 480 | 15 | 1.5 | 10 | 7200 | 720 | 250 | 0.11 |
| 600 | 12 | 1.2 | 10 | 7200 | 720 | 250 | 0.11 |

Dimensions

Approximate Dimensions in Inches or Inches (mm)

Side Rotary Operated Head with Switch

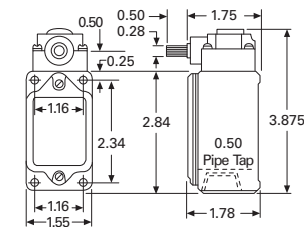

(2) 0.203 Dia. Holes for Front Mtg.
(2) 10-32 Tapped Holes 0.375 Deep for Rear Mtg.

Side Pushbutton, Adjustable

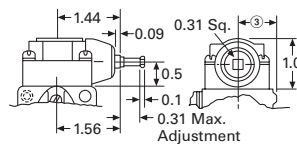

Top Pushbutton

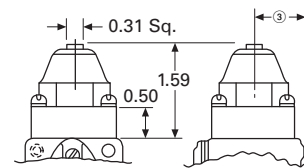

Side Push, Vertical Roller

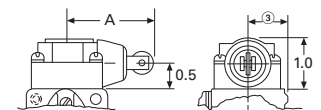

Dimension "A"

| | |
|------------------------------|-------------|
| With 0.44 (11.2) dia. roller | 1.78 (45.2) |
| With 0.75 (19.1) dia. roller | 2.09 (53.1) |

Side Push Maintained Contact

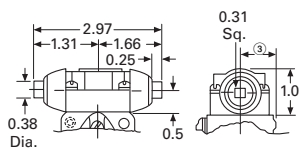

Top Push Roller

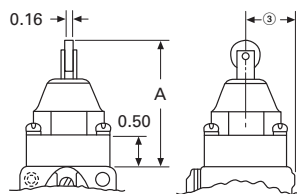

Dimension "A"

| | |
|------------------------------|-------------|
| With 0.44 (11.2) dia. roller | 2.03 (51.6) |
| With 0.75 (19.1) dia. roller | 2.34 (59.4) |

Wobble Operators

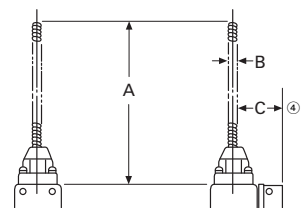

| A | B | C |
|---------------------------|------------|-------------|
| Wobble Spring | | |
| 5.44 (138.2) | 0.31 (7.9) | 0.81 (20.6) |
| Wire Wobble Stick | | |
| 12.5 (317.5) | 0.08 (2.0) | 0.81 (20.6) |
| Nylon Wobble Stick | | |
| 4.5 (114.3) | 0.25 (6.4) | 0.81 (20.6) |

Notes

- ① Ranges below 32°F (0°C) are based on absence of freezing moisture or water.
- ② Contacts must be same polarity when both circuits are used.
- ③ Dimension from centerline of head to mounting surface is 0.78 in (20 mm).
- ④ Center to mounting surface.

Hazardous Location Limit Switches

2



Hazardous Location Limit Switches

Product Description

Type LX, CX and CBX limit switches by Eaton's electrical sector are designed for extreme environmental service in NEMA 7–9 locations where the danger of an internal or external explosion of flammable gases, vapors, metal alloy or grain dust exists. Type CB provides excellent corrosion resistant properties in NEMA 4X applications. Markets served include mining, grain storage, forest products, petrochemical, pharmaceutical and waste and sewage management.

Features

- Sealed and unsealed versions available
- One-way gasket on sealed version keeps liquids out, yet allows a harmless release of gases in the event of an internal explosion
- Silicon bronze housing provides excellent corrosion resistant properties in extreme NEMA 4X applications
- Temperature buildup on limit switch surface is dissipated by housing design and materials used
- Utilizes the operating heads and internal switch mechanisms of the 10316 L non plug-in line

Contents

Description

| | <i>Page</i> |
|---|-----------------|
| Hazardous Location Limit Switches | |
| Product Selection | V8-T2-93 |
| Technical Data and Specifications | V8-T2-94 |
| Dimensions | V8-T2-91 |

Standards and Certifications

- cUL



NEMA Ratings Comparison

| Switch Type | LX | CX | CBX | CB ① |
|---|----|----|-----|------|
| NEMA 1, 4, 13 | — | ✓ | ✓ | ✓ |
| NEMA 4X | — | — | ✓ | ✓ |
| NEMA 7 Division I, Class I, BCD | ✓ | ✓ | ✓ | — |
| NEMA 9 Division I, Class II, EFG | ✓ | ✓ | ✓ | — |

Note

① Not rated for explosive locations.



DANGER
THIS SENSOR IS NOT A SAFETY DEVICE AND IS NOT INTENDED TO BE USED AS A SAFETY DEVICE. This sensor is designed only to detect and read certain data in an electronic manner and perform no use apart from that, specifically no safety-related use. This sensor product does not include self-checking redundant circuitry, and the failure of this sensor product could cause either an energized or de-energized output condition, which could result in death, serious bodily injury, or property damage.

For the most current information on this product, visit our Web site: www.eaton.com

For Customer Service in the U.S. call 1-877-ETN CARE (386-2273), in Canada call 1-800-268-3578. For Application Assistance in the U.S. and Canada call 1-800-426-9184.

Product Selection

Complete Assembled Switches with Spring Return Heads ^①

Operating Data—Nominal

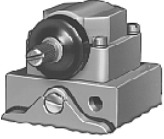
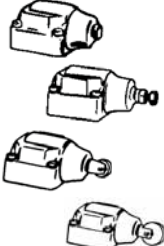
| Head Type | Travel to Operate Contacts | Travel to Reset Contacts | Total Travel | Force to Operate Contacts | Minimum Return Force | Body Type | Contacts | Catalog Number | |
|---|--|---|------------------|---------------------------|----------------------|----------------------|--------------------------|----------------------|-------------------|
| Side Rotary Operated ^②  | Standard, 10° Pre-Travel ^③ | | | | | | | | |
| | 10° | 4° | 50° | 3.0 in-lbs | 4.5 in-oz | Type LX | 1NO-1NC ^④ | 10316H1002 | |
| | | | | | | | 2NO | 10316H1039 | |
| | | | | | | | 1NO and 1NC ^④ | 10316H1049 | |
| | | | | | | | 2NC | 10316H1059 | |
| | | | | | | Type CX | 1NO-1NC ^④ | 10316H2200 | |
| | | | | | | | 1NO and 1NC ^④ | 10316H2176 | |
| | | | | | | | 2NC | 10316H2178 | |
| | | | | | | Type CB | 1NO-1NC ^④ | 10316H2149 | |
| | | | | | | | 2NC | 10316H2140 | |
| | | | | | | Type CBX | 1NO-1NC ^④ | 10316H2168 | |
| | | | | | | | 2NC | 10316H2159 | |
| | | Narrow Differential 5° Pre-Travel ^③ | | | | | | | |
| | | 5° | 2° | 50° | 6.0 in-lbs | 4.5 in-oz | Type LX | 1NO-1NC ^④ | 10316H1146 |
| | | | | | | Type CX | 1NO-1NC ^④ | 10316H2197 | |
| | Neutral Position, 18° Pre-Travel ^⑤ | | | | | | | | |
| | 18° | 6° | 50° | 1.8 in-lbs | 2.5 in-oz | Type LX | 2NO | 10316H1071 | |
| | | | | | | | 2NC | 10316H1072 | |
| | | | | | | Type CX | 2NO | 10316H2179 | |
| | | | | | | Type CBX | 2NC | 10316H2160 | |
| Side Push Operated  | Pushbutton | | | | | | | | |
| | 0.07 in (1.8 mm) | 0.03 in (0.76 mm) | 0.29 in (7.4 mm) | 4 lbs | 8 oz | Type LX | 1NO and 1NC ^④ | 10316H1213 | |
| | Adjustable Pushbutton | | | | | | | | |
| | 0.07 in (1.8 mm) | 0.03 in (0.76 mm) | 0.29 in (7.4 mm) | 4 lbs | 8 oz | Type LX | 1NO-1NC ^④ | 10316H1192 | |
| | Vertical Roller, 0.44 in (11.2 mm) Diameter | | | | | | | | |
| | 0.07 in (1.8 mm) | 0.03 in (0.76 mm) | 0.29 in (7.4 mm) | 4 lbs | 8 oz | Type LX | 1NO-1NC ^④ | 10316H1007 | |
| Vertical Roller, 0.75 in (19.1 mm) Diameter | | | | | | | | | |
| 0.07 in (1.8 mm) | 0.03 in (0.76 mm) | 0.29 in (7.4 mm) | 4 lbs | 8 oz | Type LX | 1NO-1NC ^④ | 10316H1194 | | |

Notes

- ① Contact Eaton's Sensor Applications Engineering at 1-800-426-9184 for replacement contact blocks.
- ② For operating levers, see **Page V8-T2-80**. Only levers with Nylatron rods or rollers should be used with explosion-proof limit switches.
- ③ Field convertible to clockwise only or counterclockwise only operation.
- ④ 1NO-1NC contacts must be same polarity when both circuits are used—1NO and 1NC contacts have isolated poles and may be used on opposite polarity.
- ⑤ Neutral position switches operate one circuit in each direction.

Complete Assembled Switches with Spring Return Heads, continued ^①

Operating Data—Nominal

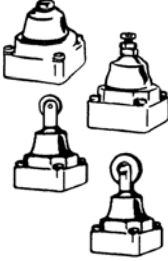
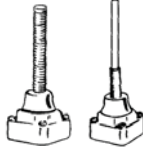
| Head Type | Travel to Operate Contacts | Travel to Reset Contacts | Total Travel | Force to Operate Contacts | Minimum Return Force | Body Type | Contacts | Catalog Number |
|---|---|--------------------------|------------------|---------------------------|----------------------|----------------------|--------------------------|-------------------|
| Top Push Operated  | Pushbutton | | | | | | | |
| | 0.04 in (1 mm) | 0.02 in (0.5 mm) | 0.28 in (7.1 mm) | 4 lbs | 8 oz | Type LX | 1NO-1NC ^② | 10316H1004 |
| | | | | | | Type CX | 1NO and 1NC ^② | 10316H2188 |
| | Adjustable Pushbutton | | | | | | | |
| | 0.04 in (1 mm) | 0.02 in (0.5 mm) | 0.28 in (7.1 mm) | 4 lbs | 8 oz | Type LX | 1NO-1NC ^② | 10316H1191 |
| | | | | | | | 1NO and 1NC ^② | 10316H1212 |
| | Roller, 0.44 in (11.2 mm) Diameter | | | | | | | |
| | 0.04 in (1 mm) | 0.02 in (0.5 mm) | 0.28 in (7.1 mm) | 4 lbs | 8 oz | Type LX | 1NO-1NC ^② | 10316H1006 |
| | | | | | | Type CBX | 1NO-1NC ^② | 10316H2170 |
| | Roller, 0.75 in (19.1 mm) Diameter | | | | | | | |
| 0.04 in (1 mm) | 0.02 in (0.5 mm) | 0.28 in (7.1 mm) | 4 lbs | 8 oz | Type LX | 1NO-1NC ^② | 10316H1193 | |
| Wobble Operated  | Spring | | | | | | | |
| | 10° ^③ | 6° | 15° | 1 in-lb | 2.4 in-oz | Type LX | 1NO-1NC ^② | 10316H1237 |
| | Nylon Rod | | | | | | | |
| | 10° ^③ | 6° | 15° | 2 in-lbs | 5.6 in-oz | Type LX | 1NO-1NC ^② | 10316H1009 |

Technical Data and Specifications

Hazardous Location Limit Switches

| Description | Specification |
|-------------------------------|---|
| Material of construction | |
| LX, CX | Cast aluminum die cast |
| CB, CBX | Silicon bronze |
| Conduit entrance | |
| LX | 1/2 in pipe tap |
| CB, CBX, CX | 3/4 in pipe tap |
| Mounting | Surface mount |
| Enclosure rating | |
| LX, CX, CBX | NEMA 7 Div. 1, Class I BCD; NEMA 9 Div. 1, Class II, EFG ^④ |
| CB, CBX | NEMA 1, 4, 4X, 13 ^④ |
| CX | NEMA 1, 4, 13 ^④ |
| Ambient operating temperature | -20° to 200°F (-29° to 93°C) ^⑤ |
| Approximate shipping weight | |
| LX | 2 lbs |
| CX | 2.5 lbs |
| CB, CBX | 6 lbs |

Notes

- ^① Contact Eaton's Sensor Applications Engineering at 1-800-426-9184 for replacement contact blocks.
- ^② 1NO-1NC contacts must be same polarity when both circuits are used—1NO and 1NC contacts have isolated poles and may be used on opposite polarity.
- ^③ Travel with force applied at one-in (25.4 mm) radius. Applied at end of operator, travel is approximately 14.
- ^④ A conduit seal-off kit is required for these switches
- ^⑤ Ranges below 32°F (0°C) are based on absence of freezing moisture or water.

Electrical Data—Maximum Contact Ratings, per Pole

| AC Volts | Current, Amperes | | Cont. ① | Volt Amperes | | DC Volts | DC Current, Ampere |
|---------------------------------|------------------|-------|---------|--------------|-------|----------|--------------------|
| | Make | Break | | Make | Break | | |
| 1NO-1NC Switches | | | | | | | |
| NEMA A600, R300 rating | | | | | | | |
| 120 | 60 | 6 | 10 | 7200 | 720 | 125 | 0.2 |
| 240 | 30 | 3 | 10 | 7200 | 720 | 250 | 0.1 |
| 480 | 15 | 1.5 | 10 | 7200 | 720 | 250 | 0.1 |
| 600 | 12 | 1.2 | 10 | 7200 | 720 | 250 | 0.1 |
| All Other Switches, B600 | | | | | | | |
| 120 | 30 | 3 | 5 | 3600 | 360 | 120 | 0.1 |
| 240 | 15 | 1.5 | 5 | 3600 | 360 | 240 | 0.05 |
| 480 | 7.5 | 0.75 | 5 | 3600 | 360 | 240 | 0.05 |
| 600 | 6 | 0.60 | 5 | 3600 | 360 | 240 | 0.05 |

Dimensions

Approximate Dimensions in Inches or Inches (mm)

Type LX Switch with Side Rotary Head

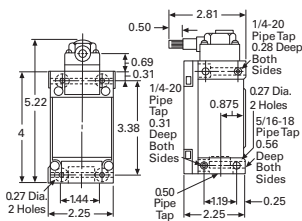

Side Pushbutton Head

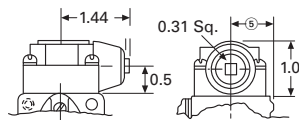

Top Pushbutton Head

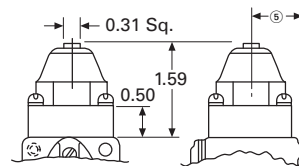

Side Push, Vertical Roller Head

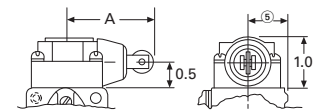

Dimension "A"

| | |
|------------------------------|-------------|
| With 0.44 (11.2) dia. roller | 1.78 (45.2) |
| With 0.75 (19.1) dia. roller | 2.09 (53.1) |

Type CX, CB and CBX Switches with Side Rotary Head

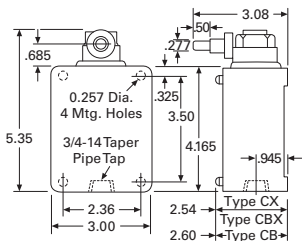

Adjustable Top Pushbutton Head

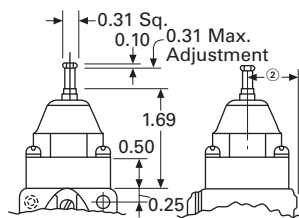

Wobble Operators

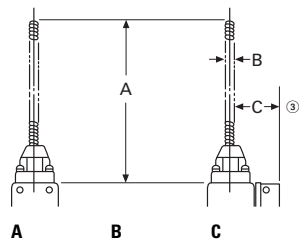

Notes

- ① 1NO-1NC contacts must be same polarity when both circuits are used—1NO and 1NC contacts have isolated poles and may be used on opposite polarities.
- ② Dimension from centerline of head to mounting surface is 0.78 in (20 mm).
- ③ Center to mounting surface.

Adjustable Side Pushbutton Head

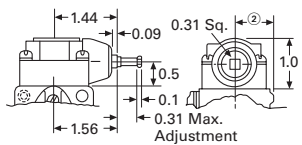

Top Push Roller Head

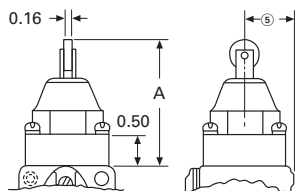

Dimension "A"

| | |
|------------------------------|-------------|
| With 0.44 (11.2) dia. roller | 2.03 (51.6) |
| With 0.75 (19.1) dia. roller | 2.34 (59.4) |

Wobble Spring

| | | |
|--------------|------------|-------------|
| 5.44 (138.2) | 0.31 (7.9) | 0.94 (23.9) |
|--------------|------------|-------------|

Nylon Red

| | | |
|-------------|------------|-------------|
| 4.5 (114.3) | 0.25 (6.4) | 0.94 (23.9) |
|-------------|------------|-------------|

Special Purpose Limit Switches

2



Special Purpose Limit Switches

Product Description

Special Purpose (Type F), Rotating Shaft (Type J), Pneumatic Time Delay (Type LP) and Precision and Cabinet Door Interlock (Type PS) Limit Switches from Eaton's electrical sector serve a variety of special purpose industrial applications for MRO and User Replacement requirements.

Features

- UL Listed
- CSA Certified (PS and J only)

Contents

Description

| | <i>Page</i> |
|---|------------------|
| Special Purpose Limit Switches | |
| Product Selection | |
| Roller Lever Switches | V8-T2-97 |
| Rotating Shaft Switches | V8-T2-97 |
| Pneumatic Time Delay Switches | V8-T2-98 |
| Precision Switches | V8-T2-98 |
| Technical Data and Specifications | V8-T2-99 |
| Dimensions | V8-T2-101 |

Standards and Certifications

Type F

- UL Listed

Type J

- UL Listed
- CSA Certified

Type LP

- UL Listed

Type PS

- UL Recognized
- CSA Certified



DANGER

THIS SENSOR IS NOT A SAFETY DEVICE AND IS NOT INTENDED TO BE USED AS A SAFETY DEVICE. This sensor is designed only to detect and read certain data in an electronic manner and perform no use apart from that, specifically no safety-related use. This sensor product does not include self-checking redundant circuitry, and the failure of this sensor product could cause either an energized or de-energized output condition, which could result in death, serious bodily injury, or property damage.

For the most current information on this product, visit our Web site: www.eaton.com

For Customer Service in the U.S. call 1-877-ETN CARE (386-2273), in Canada call 1-800-268-3578. For Application Assistance in the U.S. and Canada call 1-800-426-9184.

Product Selection

Roller Lever Switches

Roller Lever



Type F Switches ^①

| Operator | Circuit | Travel to Operate Contacts | Travel to Reset Contacts | Total Travel | Over-Travel | Catalog Number |
|--|---------|----------------------------|--------------------------|--------------|-------------|------------------|
| Roller lever (CW and CCW operation, spring return) | 1NO-1NC | 40° | 35° | 65° | 25° | 10316H18 |
| | 2NO-2NC | 17° | 6° | 60° | 43° | 10316H320 |

Rotating Shaft Switches

Type J

Rotating Shaft Limit Switches allow the shaft to be rotated a preset number of revolutions (adjustable from 1/2 to 100 with an accuracy of 1/20 of a turn) before the contacts will switch. A second set of

contacts will trip when reaching a preset limit in the opposite direction. These switches are typically used in crane and hoist applications to provide end of travel stops for the hook assembly.

Rotating Shaft



Type J Switches

| Shaft to Cam Ratio | Max. Turns to Trip Contacts | Min. Turns to Trip Contacts | Over-Travel Before Resetting Contacts | Reversal After Tripping to Reset Contacts | Circuit ^② | Enclosure Rating | Catalog Number |
|--------------------|-----------------------------|-----------------------------|---------------------------------------|---|----------------------|------------------|------------------------------|
| 103:1 | 100 input shaft turns | 1/2 input shaft turns | 103 input shaft turns max. | 1/8 input shaft turns min. | 2NC | NEMA 1 | 10316H50 |
| | | | | | 2NO-2NC ^③ | NEMA 4 | 10316H54 ^③ |

Notes

- ① Replacement operator head is available with part number **86-862-22**.
Replacement roller lever is available with part number **24-1712**.
Replacement key pin and washer for roller is available with part number **16-906**.
- ② For replacement NO contacts, order **17-1403**; NC contacts, order **17-702**.
- ③ 10316H54 has factory set circuits, but is easily convertible to any of three circuits (2NO-2NC, 4NO or 4NC). Full instructions enclosed with every switch.

Pneumatic Time Delay Switches

Pneumatic Time Delay

Type LP Switches



| Operator | Total Travel | Pre-Travel | Circuit | Timed Contacts | Direction of Rotation ^② | Catalog Number |
|---|--------------|------------|---------|----------------|------------------------------------|----------------|
| Side rotary (Spring return to center) ^① | 50° | 10° | 1NO-1NC | ON delay | CW | 10316H1580 |
| | | | | | CW and CCW | 10316H1600 |
| | | | | OFF delay | CW | 10316H1610 |
| | | | | | CW and CCW | 10316H1630 |

Precision Switches

Cabinet Door Interlock

Type PS Switches



| Operator | Circuits— SPDT 1NO-1NC Catalog Number | Circuits— DPDT 2NO-2NC Catalog Number | Operator Only Catalog Number |
|--|---|---|---------------------------------|
| Precision Switch Devices | | | |
| Precision switch only | 10316H89 | 10316H2000 | — |
| Pushbutton with oiltight plunger | — | 10316H2006 | — |
| Roller with oiltight plunger perpendicular to mounting holes | — | 10316H2012 | — |
| Roller with oiltight plunger in line with mounting holes | 10316H110 | — | — |
| 6 in lever with top and right-hand mounting bracket | 10316H113 | — | 10316H143 |
| 6 in lever with top and left-hand mounting bracket | — | — | 10316H144 |
| Roller lever with top and right-hand mounting bracket | 10316H119 | — | 10316H145 |
| Roller lever with top and left-hand mounting bracket | 10316H122 | — | 10316H146 |
| One way roller lever with top and right-hand mounting bracket | — | — | 10316H147 |
| One way roller lever with top and left-hand mounting bracket | — | — | 10316H148 |
| Cabinet Door Interlocks | | | |
| Precision switch only | 10316H828 | 10316H829A | — |
| Cabinet door interlock operator with one precision switch and with red (defeated ^③) indicator | 10316H1028 | 10316H2042 | 10316H150 |
| Cabinet door interlock operator with two each of listed precision switches and with red (defeated ^③) indicator | 10316H1029 | — | — |

Notes

- ① Requires an operating lever, see **Page V8-T2-80**.
- ② Field convertible.
- ③ The plunger exposes a red band when pulled out to indicate that interlock is defeated.

Technical Data and Specifications

Special Purpose Limit Switches

| Description | Specification |
|--|--|
| Roller Lever Switches – Type F | |
| Enclosure rating | NEMA 4 |
| Operating temperature | 0° to 180°F (–18° to 82°C) |
| Conduit entrance | 0.5 in NPT |
| Shipping weight | 4.0 lbs |
| Rotating Shaft Switches – Type J | |
| Shipping weight | |
| NEMA 1 models | 5.5 lbs |
| NEMA 4 models | 13 lbs |
| Pneumatic Time Delay Switches – Type LP | |
| Timing range | 0.05 to 60 seconds |
| ON delay function | Timing begins when lever is actuated and held |
| OFF delay function | Timing begins when lever is released |
| Repeat accuracy ^① | With 15 second or higher interval between timing periods: ±10% of setting maximum With less than 15 second interval between timing periods: ±25% of setting maximum |
| Operating frequency | 250 operations per minute maximum |
| Enclosure rating | NEMA 4, 13 |
| Ambient operating temperature | 32° to 150°F (0° to 65°C) |
| Conduit entrance | 0.5 in NPT |
| Shipping weight | 2 lbs |

Note

^① To maintain operating accuracy during the timing cycle, the switch lever must be faster than the timed setting.

Type F—Maximum Ampere Ratings

| Circuit | State | AC Volts | | | | DC Volts | | |
|---------|-------|----------|-----|-----|-----|----------|-----|------|
| | | 120 | 240 | 480 | 600 | 120 | 240 | 600 |
| 1NO-1NC | Make | 60 | 30 | 20 | 15 | — | — | — |
| | Break | 6 | 3 | 1.5 | 1.2 | 2.2 | 1.1 | 0.40 |
| 2NO-2NC | Make | 40 | 20 | 10 | 8 | — | — | — |
| | Break | 15 | 10 | 6 | 5 | 0.5 | 0.2 | 0.02 |

Type J—Maximum Ampere Ratings

| State | AC Volts | | | | DC Volts | | |
|-------------------------|----------|-----|-----|-----|----------|-----|-----|
| | 120 | 240 | 480 | 600 | 120 | 240 | 600 |
| Make | 60 | 30 | 15 | 12 | 2.2 | 1.1 | — |
| Break | 6 | 3 | 1.5 | 1.2 | 2.2 | 1.1 | — |
| Continuous ^① | 10 | 10 | 10 | 10 | 10 | 10 | — |

Type LP—Electrical Data, Maximum Contact Ratings/Pole

| AC Volts | Current, Amperes | | | Volt Amperes | | DC Volts | DC Current Amperes |
|-----------------------------|------------------|-------|--------------------|--------------|-------|----------|--------------------|
| | Make | Break | Cont. ^① | Make | Break | | |
| All Switches 1NO-1NC | | | | | | | |
| NEMA A600, R300 Rating | | | | | | | |
| 120 | 60 | 6 | 10 | 7200 | 720 | 120 | 0.2 |
| 240 | 30 | 3 | 10 | 7200 | 720 | 240 | 0.1 |
| 480 | 15 | 1.5 | 10 | 7200 | 720 | 240 | 0.1 |
| 600 | 12 | 1.2 | 10 | 7200 | 720 | 240 | 0.1 |

Type PS—Maximum Ampere Ratings

| Type | State | AC Volts | | | | DC Volts Double Throw | | |
|---|-------|----------|-----|-----|-----|--------------------------|-----|------|
| | | 120 | 240 | 480 | 600 | 120 | 240 | 600 |
| Heavy-Duty 1/2 hp, 250 Vac Maximum | | | | | | | | |
| Single-pole | Make | 40 | 20 | 10 | 8 | 2.0 | 0.5 | 0.1 |
| | Break | 15 | 10 | 6 | 5 | 0.5 | 0.2 | 0.02 |
| Double-pole | Make | 30 | 15 | 8 | 6 | 0.5 | 0.2 | 0.2 |
| | Break | 3 | 1.5 | 1 | 0.8 | 0.2 | 0.1 | — |

Note

^① Thermal rating. Valid only if switch does not have to make or break.

Dimensions

Approximate Dimensions in Inches (mm)

Roller Lever Switches

Type F

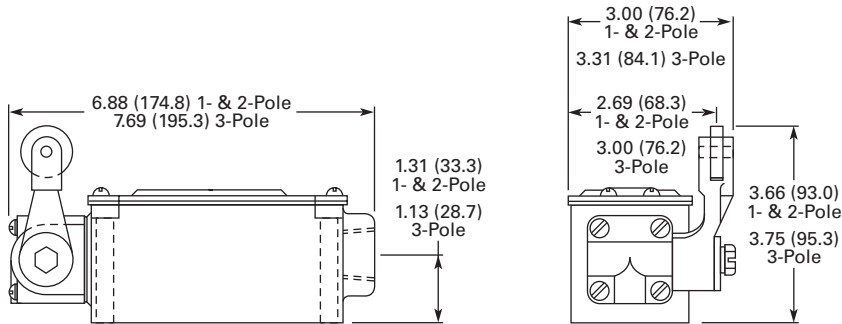

Approximate Dimensions in Inches only

Rotating Shaft Switches

Type J—NEMA 1 Models

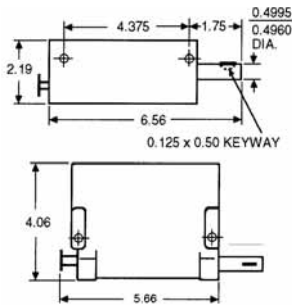

Type J—NEMA 4 Models

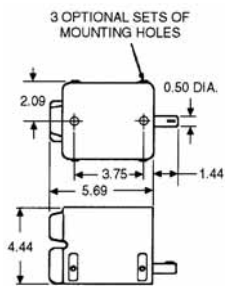

Pneumatic Time Delay Switches

Type LP

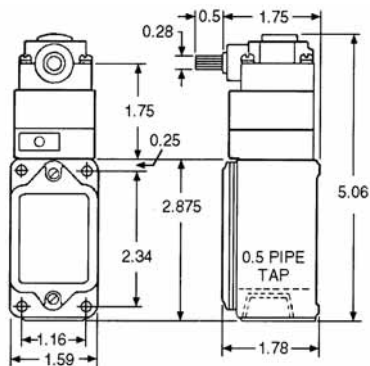

2.11

Limit Switches

Special Purpose Limit Switches

Approximate Dimensions in Inches [mm]

2

Precision Switches

Type PS

