



SAW Components

SAW duplexer

WCDMA band VIII

Series/type:	B8515
Ordering code:	B39941B8515P810
Date:	July 8, 2013
Version:	2.4



Application

- Low-loss SAW duplexer for mobile telephone WCDMA Band VIII systems
- Low insertion attenuation
- Low amplitude ripple
- Usable passband 35 MHz
- Single ended to balanced transformation in Antenna - Rx path
- Impedance transformation 50Ω to 100Ω in Antenna - Rx path
- high Tx - Rx isolation

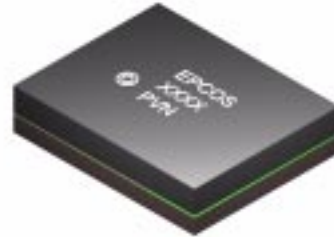

Features

- Package size 2.0 x 1.6 mm²
- Maximum package height 0.47 mm max.
- Approximate weight 0.0051 g
- RoHS compatible
- Package for **Surface Mount Technology (SMT)**
- Ni, gold-plated terminals
- **Electrostatic Sensitive Device (ESD)**
- **Moisture Sensitive Level 3**

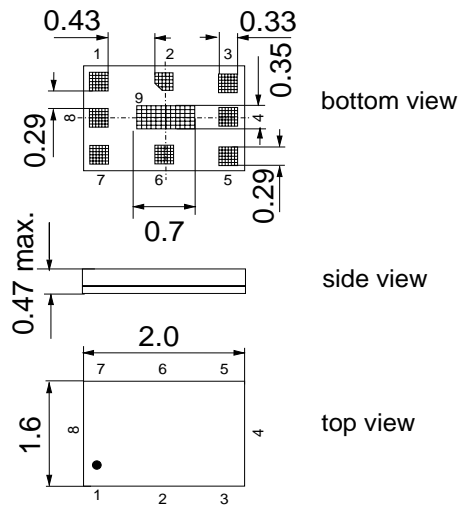

Pin configuration

- 1,8 RX output, balanced
- 3 TX input, single ended
- 6 Antenna
- 2,4,5,7,9 To be Grounded

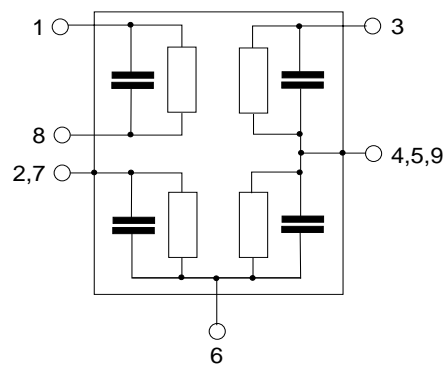



Data sheet



Characteristics

Temperature range for specification: T = -20 °C to +85 °C
 ANT terminating impedance: Z_{ANT} = 50 Ω || 5.6nH
 TX terminating impedance: Z_{TX} = 50 Ω¹⁾
 RX terminating impedance: Z_{RX} = 100 Ω (balanced)¹⁾

Characteristics Tx - Ant					min.	typ. @ 25 °C	max.	
Center frequency			f _C		—	897.5	—	MHz
Maximum insertion attenuation								
@f _{Carrier}	882.4 ... 912.6	MHz	α _{WCDMA} ²⁾		—	2.1	2.6	dB
	880.0 ... 915.0	MHz			—	2.8	3.9	dB
Amplitude ripple (p-p)								
@f _{Carrier}	882.4 ... 912.6	MHz	Δα _{WCDMA} ²⁾		—	1.2	1.8	dB
	880.0 ... 915.0	MHz			—	1.2	2.9	dB
Error Vector Magnitude								
@f _{Carrier}	882.4 ... 912.6	MHz	EVM ³⁾		—	2.3	6.0	%
@f _{Carrier}	882.4 ... 912.6	MHz	EVM ³⁾		—	2.3	4.0 ⁴⁾	%
VSWR								
TX port	880.0 ... 915.0	MHz			—	1.6	2.0	
ANT port	880.0 ... 915.0	MHz			—	1.5	2.0	
Attenuation			α					
	0.3 ... 716.0	MHz			30	37	—	dB
	716.0 ... 728.0	MHz			32	36	—	dB
	728.0 ... 865.0	MHz			30	35	—	dB
	865.0 ... 870.0	MHz			10	37	—	dB
@f _{Carrier}	927.4 ... 957.6	MHz	α _{WCDMA} ²⁾		42	50	—	dB
@f _{Carrier}	927.4 ... 957.6	MHz	α _{WCDMA} ²⁾		48 ⁴⁾	50	—	dB
	1452.0 ... 1477.0	MHz			20	47	—	dB
	1565.42 ... 1573.374	MHz			40	47	—	dB
	1573.374... 1577.466	MHz			40	46	—	dB
	1577.466... 1585.42	MHz			40	46	—	dB
	1597.55 ... 1605.89	MHz			40	45	—	dB
	1670.0 ... 1675.0	MHz			25	45	—	dB
	1760.0 ... 1830.0	MHz			35	43	—	dB

1) Appropriate matching network has to be applied towards PA and LNA. See page (9) for recommendation.

2) Attenuation of WCDMA signal ("Powertransferfunction"). Please refer to annotation on page (8).

3) Error Vector Magnitude (EVM) based on definition given in 3GPP TS 25.141.

4) T=5 °C to +85 °C



Data sheet



Characteristics

Temperature range for specification: T = -20 °C to +85 °C
 ANT terminating impedance: Z_{ANT} = 50 Ω || 5.6nH
 TX terminating impedance: Z_{TX} = 50 Ω ¹⁾
 RX terminating impedance: Z_{RX} = 100 Ω (balanced)¹⁾

Characteristics Tx - Ant				min.	typ. @ 25 °C	max.	
Attenuation							
			α				
	1830.0	... 1880.0	MHz	27	38	—	dB
	2110.0	... 2170.0	MHz	27	36	—	dB
	2400.0	... 2500.0	MHz	28	32	—	dB
	2620.0	... 2640.0	MHz	22	28	—	dB
	2640.0	... 2745.0	MHz	25	32	—	dB
	3520.0	... 3660.0	MHz	20	26	—	dB
	4400.0	... 4575.0	MHz	20	26	—	dB
	5100.0	... 5490.0	MHz	15	22	—	dB
	5490.0	... 5850.0	MHz	10	16	—	dB

¹⁾ Appropriate matching network has to be applied towards PA and LNA. See page (9) for recommendation.



Data sheet



Characteristics

Temperature range for specification: T = -20 °C to +85 °C
 ANT terminating impedance: Z_{ANT} = 50 Ω || 5.6nH
 TX terminating impedance: Z_{TX} = 50 Ω¹⁾
 RX terminating impedance: Z_{RX} = 100 Ω (balanced)¹⁾

Charcteristics Rx - Ant					min.	typ. @ 25 °C	max.	
Center frequency			f _C		—	942.5	—	MHz
Maximum insertion attenuation								
@f _{Carrier}	927.4 ... 957.6	MHz	α _{WCDMA} ²⁾		—	2.0	2.5	dB
	925.0 ... 960.0	MHz			—	2.5	3.7	dB
Amplitude ripple (p-p)								
@f _{Carrier}	927.4 ... 957.6	MHz	Δα _{WCDMA} ²⁾		—	0.6	1.2	dB
	925.0 ... 960.0	MHz			—	1.0	2.3	dB
Error Vector Magnitude								
@f _{Carrier}	927.4 ... 957.6	MHz	EVM ³⁾		—	2.7	8.0	%
@f _{Carrier}	927.4 ... 957.6	MHz	EVM ³⁾		—	2.7	4.0 ⁴⁾	%
VSWR								
RX port	925.0 ... 960.0	MHz			—	1.6	2.1	
ANT port	925.0 ... 960.0	MHz			—	1.6	2.0	
Attenuation			α					
	0.3 ... 462.0	MHz			35	62	—	dB
	462.0 ... 480.0	MHz			45	62	—	dB
	480.0 ... 835.0	MHz			38	62	—	dB
	835.0 ... 870.0	MHz			50	62	—	dB
	870.0 ... 880.0	MHz			38	62	—	dB
@f _{Carrier}	882.4 ... 912.6	MHz	α _{WCDMA} ²⁾		50	58	—	dB
	980.0 ... 1045.0	MHz			16	36	—	dB
	1045.0 ... 2400.0	MHz			35	58	—	dB
	2400.0 ... 2500.0	MHz			45	58	—	dB
	2500.0 ... 4810.0	MHz			35	55	—	dB
	5100.0 ... 5825.0	MHz			35	54	—	dB
Common Mode Rejection Ratio			α					
	925.0 ... 960.0	MHz			23	28	—	dB

1) Appropriate matching network has to be applied towards PA and LNA. See page (9) for recommendation.
 2) Attenuation of WCDMA signal ("Powertransferfunction"). Please refer to annotation on page (8).
 3) Error Vector Magnitude (EVM) based on definition given in 3GPP TS 25.141.
 4) T=5 °C to +85 °C



SAW Components

B8515

SAW duplexer

897.5 / 942.5 MHz

Data sheet



Characteristics

Temperature range for specification: T = -20 °C to +85 °C
 ANT terminating impedance: Z_{ANT} = 50 Ω || 5.6nH
 TX terminating impedance: Z_{TX} = 50 Ω ¹⁾
 RX terminating impedance: Z_{RX} = 100 Ω (balanced)¹⁾

Charcteristics Rx - Ant	min.	typ. @ 25 °C	max.	
IMD product level limits²⁾				
at f_{TX} = 897.5MHz, f_{RX} = 942.5MHz				
Blocker 1 45.0 MHz	—	-126	-110	dBm
Blocker 2 852.5 MHz	—	-110	-100	dBm
Blocker 3 1840.0 MHz	—	-110	-100	dBm
Blocker 4 2737.5 MHz	—	-110	-100	dBm

¹⁾ Appropriate matching network has to be applied towards PA and LNA. See page (9) for recommendation.

²⁾ Power levels: 21.5 dBm Tx signal, -15dBm blocker at antenna port.

Charcteristics Tx - Rx	min.	typ. @ 25 °C	max.	
Differential Mode Isolation				
@f _{Carrier} 882.4 ... 912.6 MHz α _{WCDMA} ²⁾	56	63	—	dB
@f _{Carrier} 927.4 ... 957.6 MHz α _{WCDMA} ²⁾	50	58	—	dB
Common Mode Isolation				
@f _{Carrier} 882.4 ... 912.6 MHz α _{WCDMA} ²⁾	55	63	—	dB

¹⁾ Appropriate matching network has to be applied towards PA and LNA. See page (9) for recommendation.

²⁾ Attenuation of WCDMA signal ("Powertransferfunction"). Please refer to annotation on page (8).



SAW Components **B8515**

SAW duplexer **897.5 / 942.5 MHz**

Data sheet



Maximum ratings

Storage temperature range	T _{stg}	-40/+85 ¹⁾	°C	
DC voltage	V _{DC}	5	V	
ESD voltage	V _{ESD}	100 ²⁾	V	machine model, 10 pulses
ESD voltage	V _{ESD}	300 ³⁾	V	HBM,+/- 1 pulses
ESD voltage	V _{ESD}	600 ⁴⁾	V	CDM,+/- 3 pulses
Input power at	P _{IN}			
880.0 ... 915.0 MHz		29	dBm	} WCDMA signal 55 °C, 10000 h
elsewhere		10	dBm	

- 1) Extended upperlimit: 168@125°C acc. to IEC 60068-2-2 Bb.
- 2) acc. to JESD22-A115B (machine model), 10 negative & 10 positive pulses.
- 3) acc. to JESD22-A114F (human body model), 1 negative & 1 positive pulses.
- 4) acc. to JESD22-A101C (charge device model), 3 negative & 3 positive pulse



Data sheet



Matching circuit to terminating impedances

(element values depend upon pcb layout)

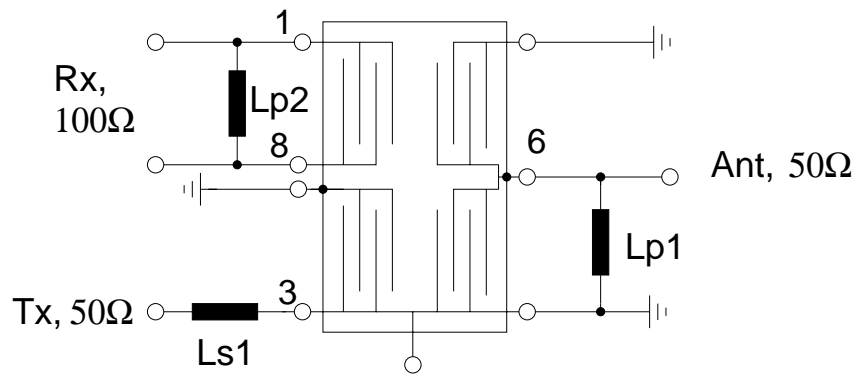

Lp1 = 5.6nH

Lp2 = 82.0nH

Ls1 = 1.0nH



Frequency Response TX-ANT (Power transfer function)

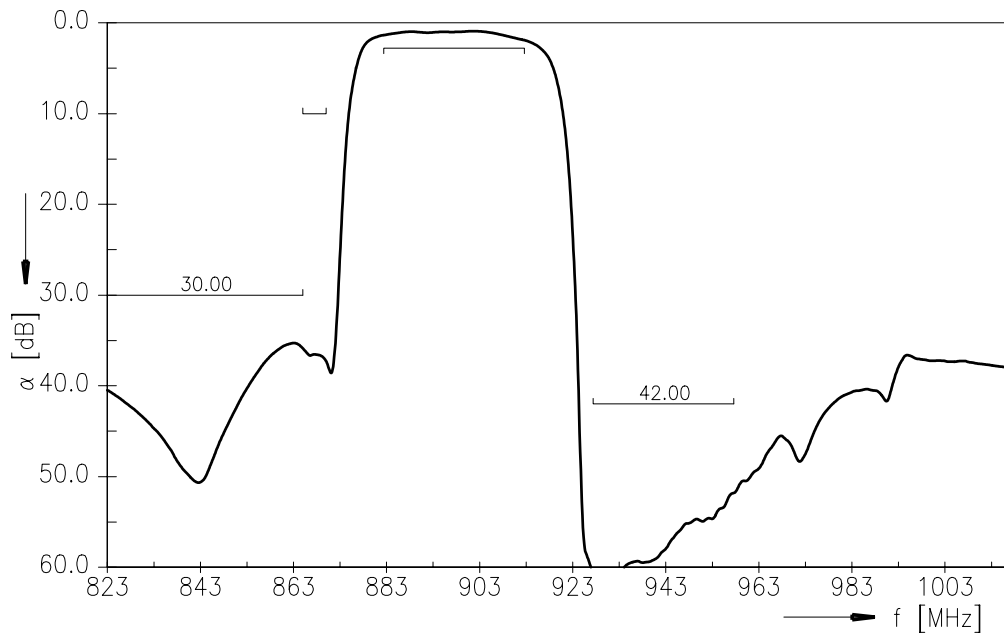

Frequency Response TX-ANT (CW test signal)

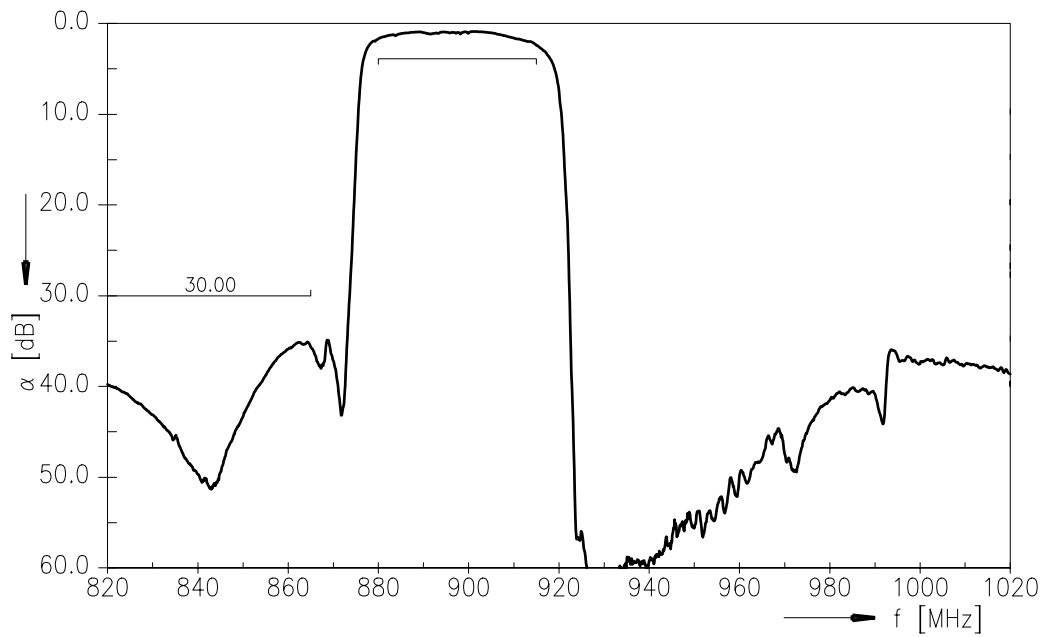



Frequency Response TX-ANT (Passband, power transfer function)

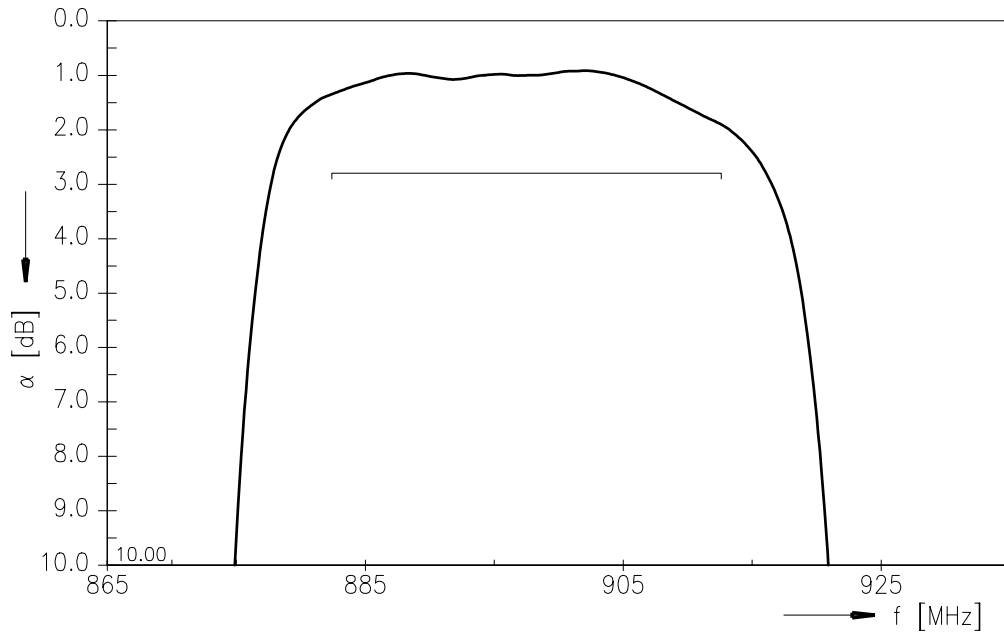

Frequency Response TX-ANT (Passband, CW test signal)

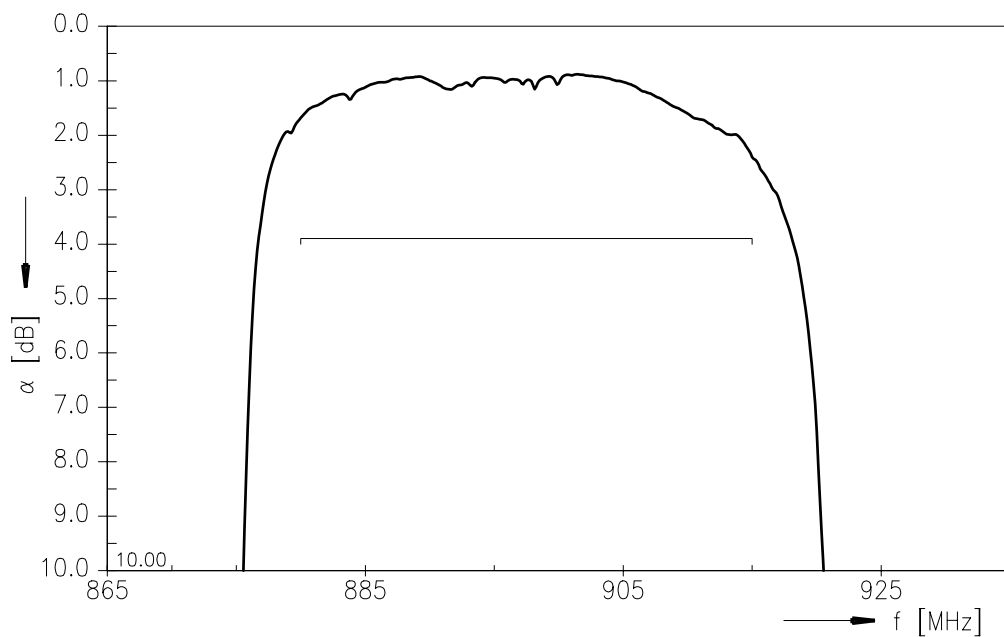



SAW Components

B8515

SAW duplexer

897.5 / 942.5 MHz

Data sheet



Frequency Response TX-ANT (wideband)

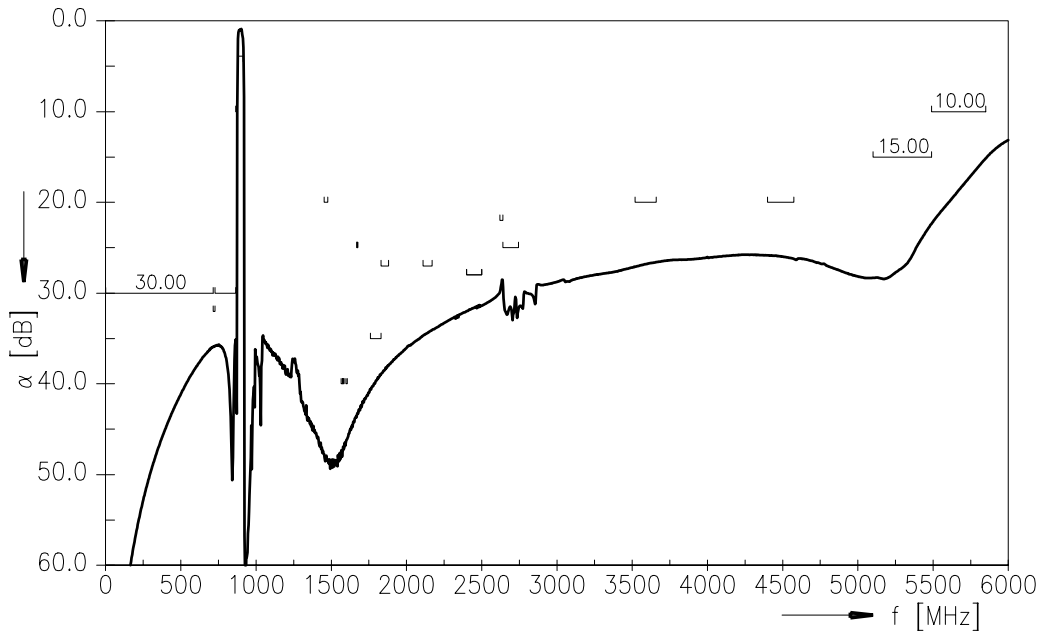

Frequency Response ANT- RX (Power transfer function)

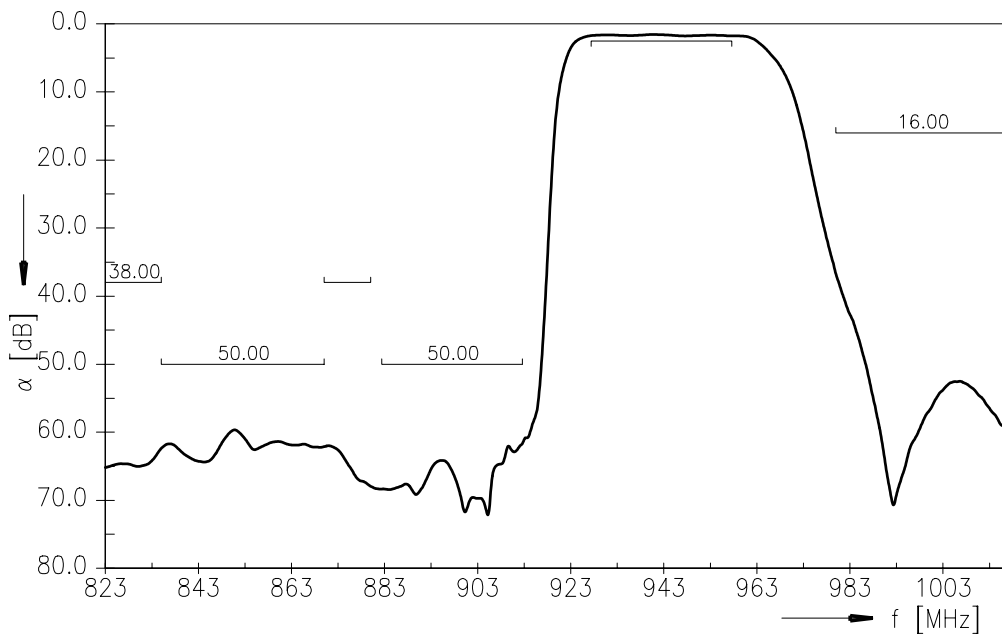

Please read *cautions and warnings* and *important notes* at the end of this document.



SAW Components

B8515

SAW duplexer

897.5 / 942.5 MHz

Data sheet



Frequency Response ANT- RX (CW test signal)

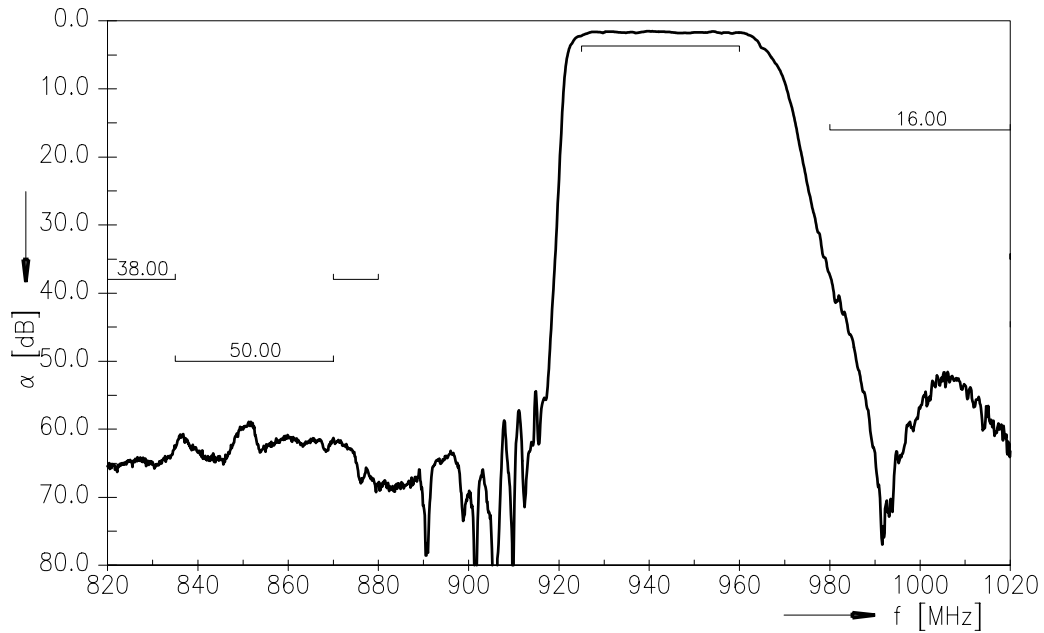

Frequency Response ANT- RX (Passband, power transfer function)

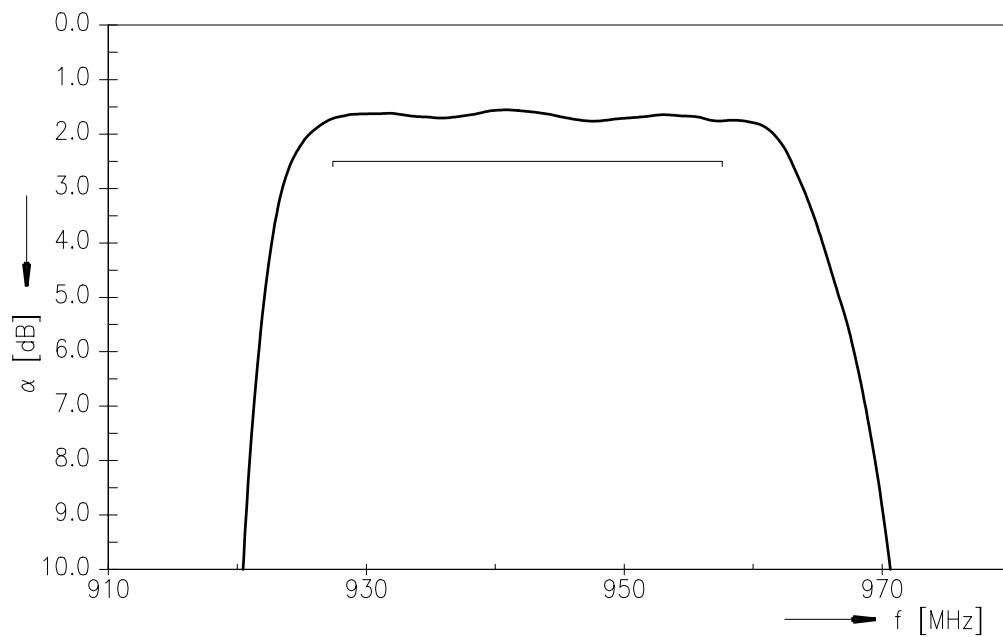

Please read *cautions and warnings* and *important notes* at the end of this document.



Frequency Response ANT- RX (Passband, CW test signal)

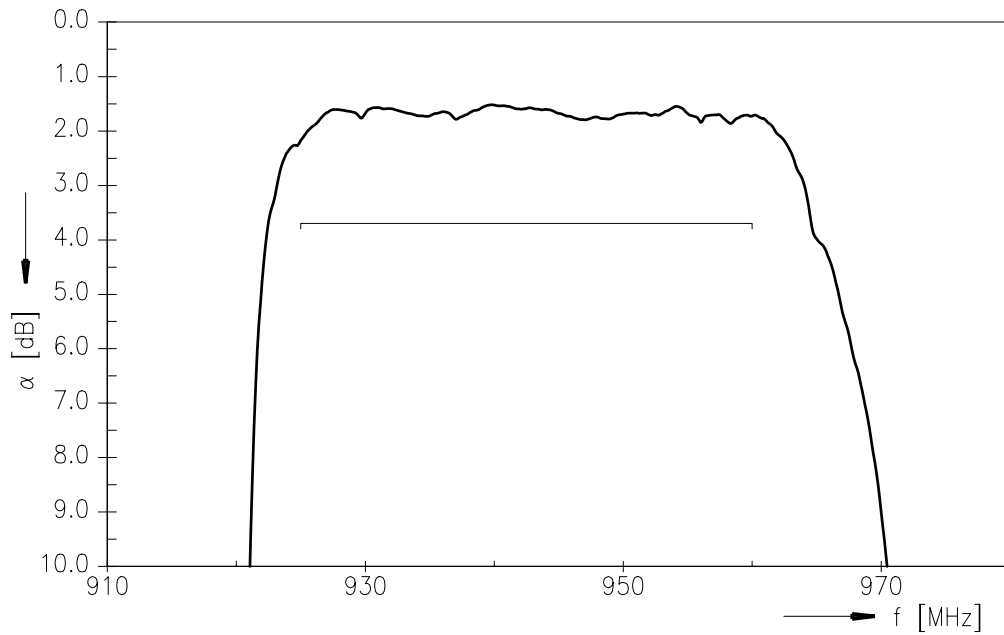

Frequency Response ANT - RX (wideband)

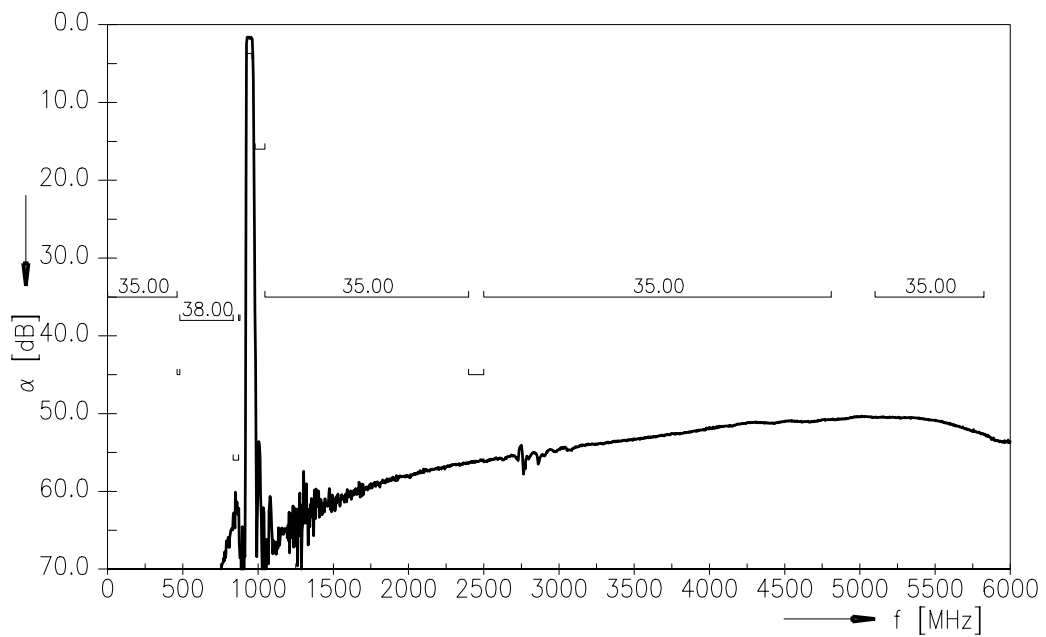



Frequency Response TX - RX (Power transfer function, differential mode)

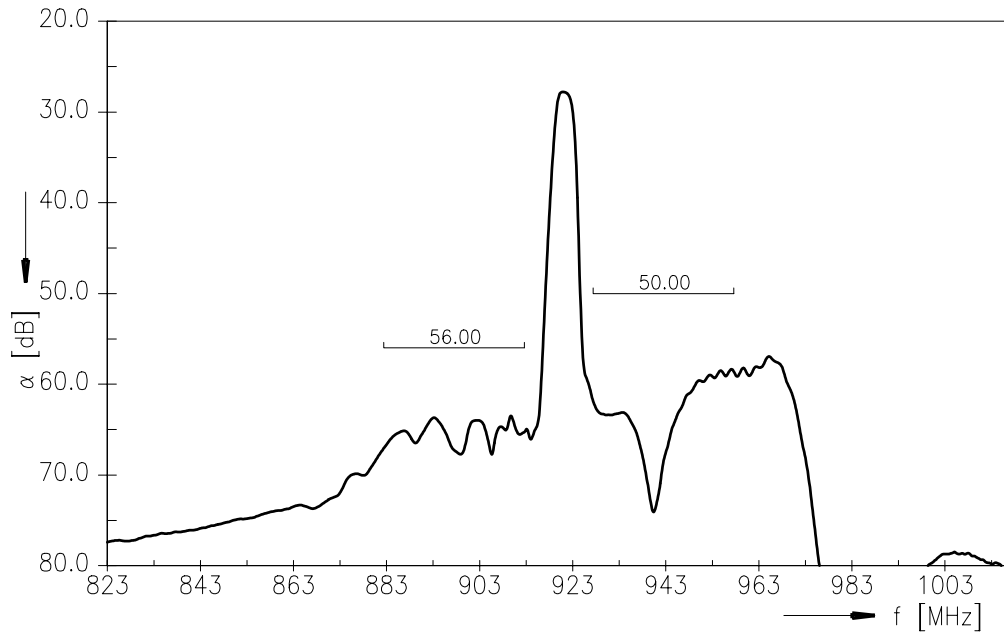

Frequency Response TX-RX (differential, CW signal)

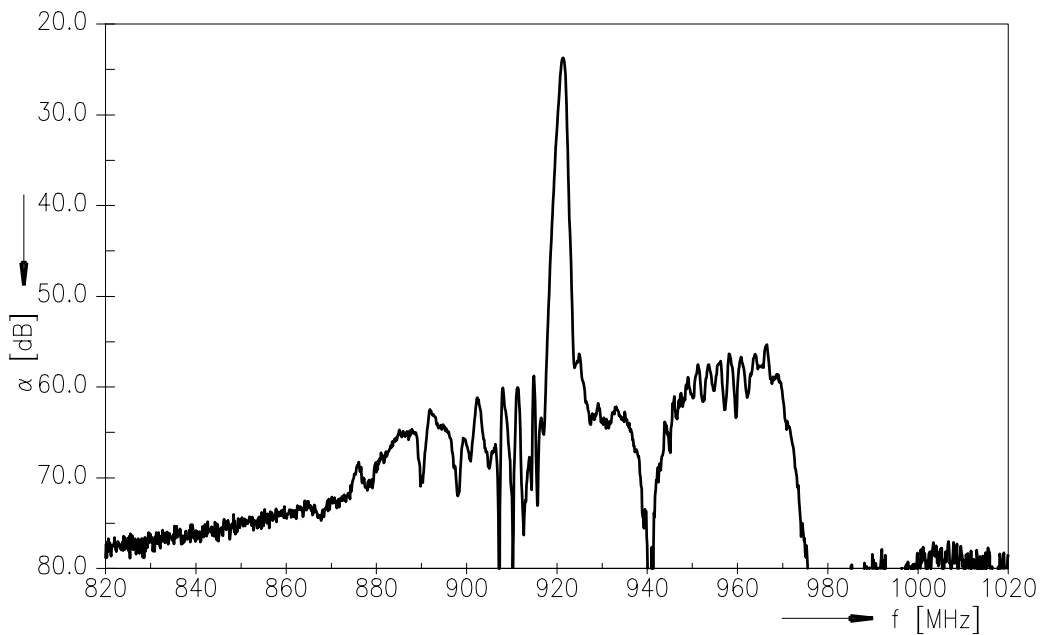



SAW Components

B8515

SAW duplexer

897.5 / 942.5 MHz

Data sheet



Frequency Response TX - RX (common mode, CW signal)

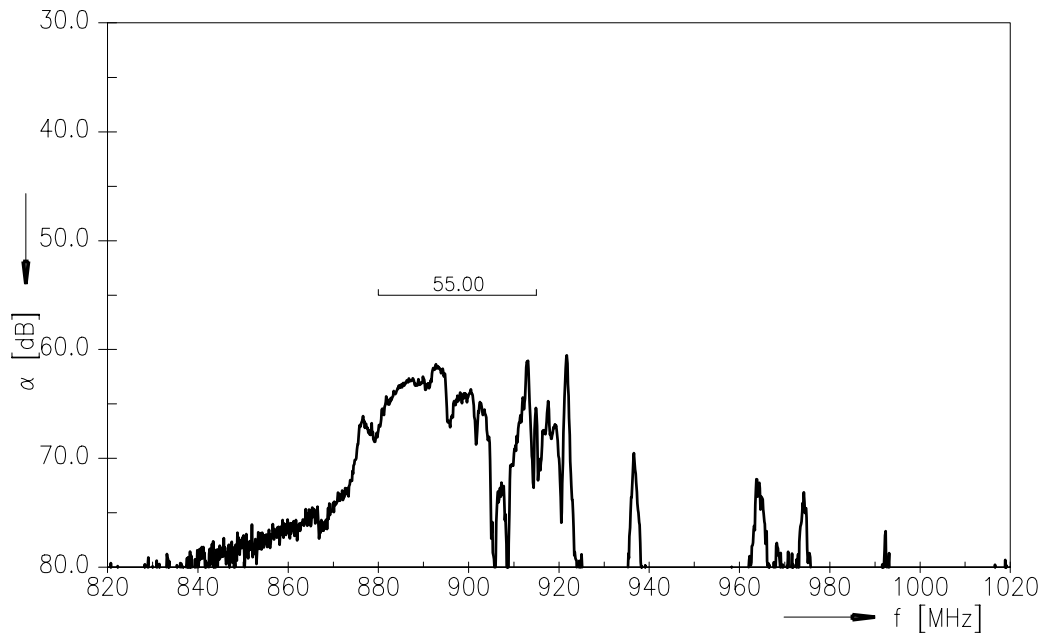



Matching (TX, RX, ANT)

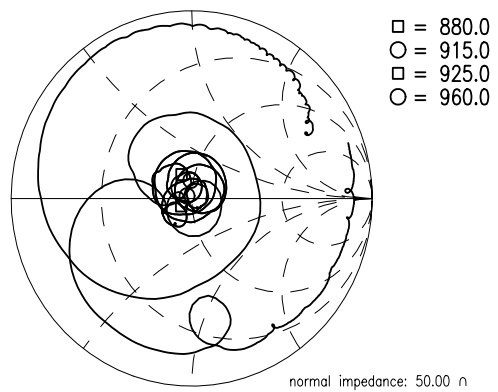
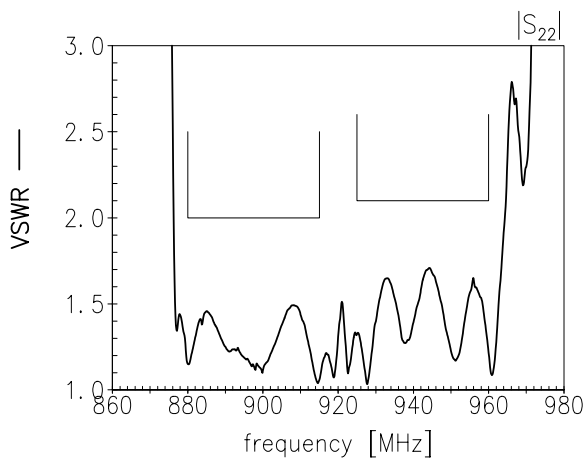
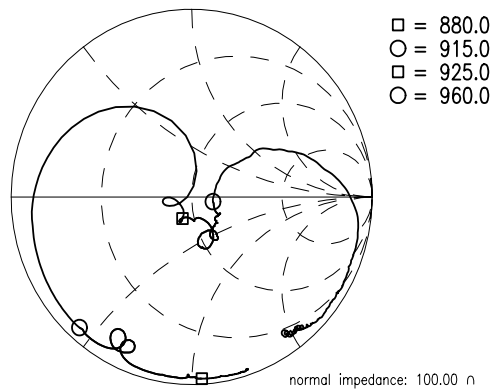
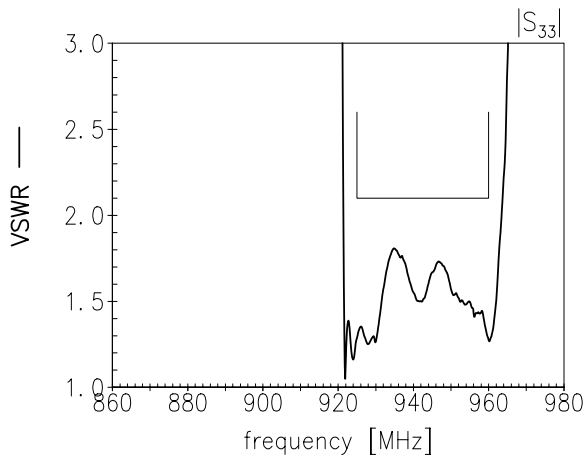
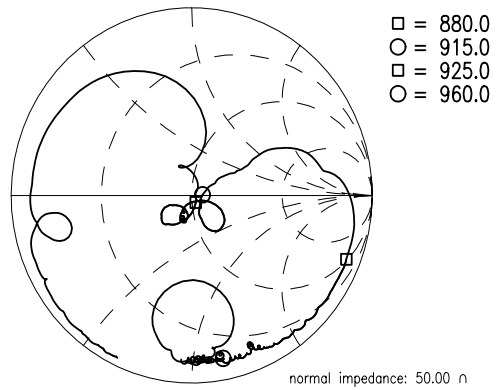
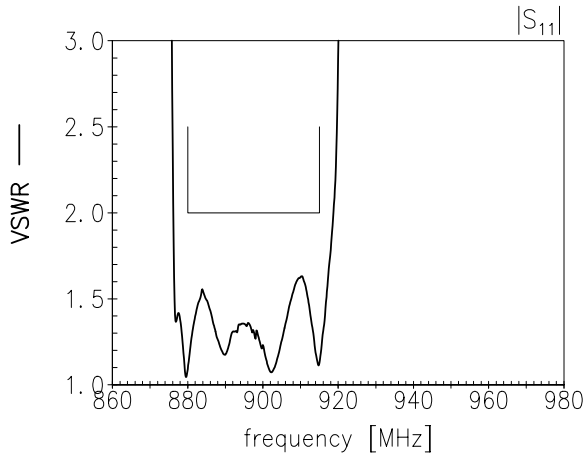

**SAW Components****B8515****SAW duplexer****897.5 / 942.5 MHz**

Data sheet

**References**

Type	B8515
Ordering code	B39941B8515P810
Marking and package	C61157-A8-A38
Packaging	F61074-V8247-Z000
Date codes	L_1126
S-parameters	B8515_NB_UN.s4p, B8515_WB_UN.s4p see file header for port/pin assignment table
Soldering profile	S_6001
RoHS compatible	defined as compatible with the following documents: "DIRECTIVE 2002/95/EC OF THE EUROPEAN PARLIAMENT AND OF THE COUNCIL of 27 January 2003 on the restriction of the use of certain hazardous substances in electrical and electronic equipment. 2005/618/EC from April 18th, 2005, amending Directive 2002/95/EC of the European Parliament and of the Council for the purposes of establishing the maximum concentration values for certain hazardous substances in electrical and electronic equipment."
Moldability	Before using in overmolding environment, please contact your EPCOS sales office.
Matching coils	See Inductor pdf-catalog http://www.tdk.co.jp/tefe02/coil.htm#aname1 and Data Library for circuit simulation http://www.tdk.co.jp/etvcl/index.htm

For further information please contact your local EPCOS sales office or visit our webpage at www.epcos.com.

Published by EPCOS AG
Systems, Acoustics, Waves Business Group
P.O. Box 80 17 09, 81617 Munich, GERMANY

© EPCOS AG 2012. This brochure replaces the previous edition.

For questions on technology, prices and delivery please contact the Sales Offices of EPCOS AG or the international Representatives.

Due to technical requirements components may contain dangerous substances. For information on the type in question please also contact one of our Sales Offices.

Please read *cautions and warnings and important notes* at the end of this document.



Important notes

The following applies to all products named in this publication:

1. Some parts of this publication contain **statements about the suitability of our products for certain areas of application**. These statements are based on our knowledge of typical requirements that are often placed on our products in the areas of application concerned. We nevertheless expressly point out **that such statements cannot be regarded as binding statements about the suitability of our products for a particular customer application**. As a rule, EPCOS is either unfamiliar with individual customer applications or less familiar with them than the customers themselves. For these reasons, it is always ultimately incumbent on the customer to check and decide whether an EPCOS product with the properties described in the product specification is suitable for use in a particular customer application.
2. We also point out that **in individual cases, a malfunction of electronic components or failure before the end of their usual service life cannot be completely ruled out in the current state of the art, even if they are operated as specified**. In customer applications requiring a very high level of operational safety and especially in customer applications in which the malfunction or failure of an electronic component could endanger human life or health (e.g. in accident prevention or life-saving systems), it must therefore be ensured by means of suitable design of the customer application or other action taken by the customer (e.g. installation of protective circuitry or redundancy) that no injury or damage is sustained by third parties in the event of malfunction or failure of an electronic component.
3. **The warnings, cautions and product-specific notes must be observed.**
4. In order to satisfy certain technical requirements, **some of the products described in this publication may contain substances subject to restrictions in certain jurisdictions (e.g. because they are classed as hazardous)**. Useful information on this will be found in our Material Data Sheets on the Internet (www.epcos.com/material). Should you have any more detailed questions, please contact our sales offices.
5. We constantly strive to improve our products. Consequently, **the products described in this publication may change from time to time**. The same is true of the corresponding product specifications. Please check therefore to what extent product descriptions and specifications contained in this publication are still applicable before or when you place an order. We also **reserve the right to discontinue production and delivery of products**. Consequently, we cannot guarantee that all products named in this publication will always be available. The aforementioned does not apply in the case of individual agreements deviating from the foregoing for customer-specific products.
6. Unless otherwise agreed in individual contracts, **all orders are subject to the current version of the "General Terms of Delivery for Products and Services in the Electrical Industry" published by the German Electrical and Electronics Industry Association (ZVEI)**.
7. The trade names EPCOS, BAOKE, Alu-X, CeraDiode, CeraLink, CSMP, CSSP, CTVS, DeltaCap, DigiSiMic, DSSP, FilterCap, FormFit, MiniBlue, MiniCell, MKD, MKK, MLSC, MotorCap, PCC, PhaseCap, PhaseCube, PhaseMod, PhiCap, SIFERRIT, SIFI, SIKOREL, SilverCap, SIMDAD, SiMic, SIMID, SineFormer, SIOV, SIP5D, SIP5K, ThermoFuse, WindCap are **trademarks registered or pending** in Europe and in other countries. Further information will be found on the Internet at www.epcos.com/trademarks.