

REVISIONS

DOC. NO. SPC-F005 * Effective: 7/8/02 * DCP No: 1398

DCP #	REV	DESCRIPTION	DRAWN	DATE	CHECKD	DATE	APPRVD	DATE
1891	A	RELEASED	EO	06/27/06	SA	7/25/06	HO	7/25/06



FRONT VIEW OF 8P6C TELEPHONE JACK

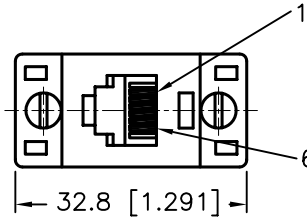
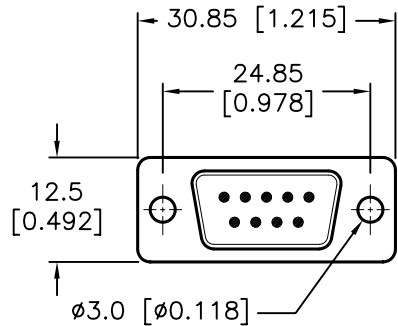
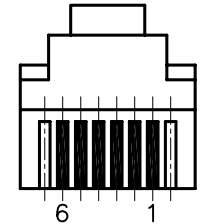

WIRE SYSTEM

	2	3	4	5	6
WHITE	BLACK	RED	GREEN	YELLOW	BLUE

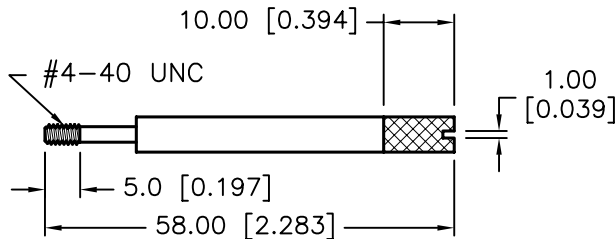
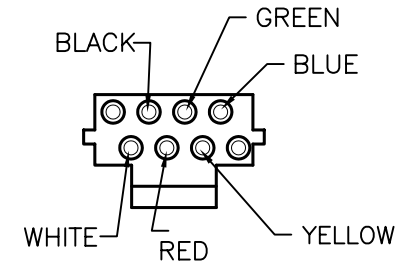
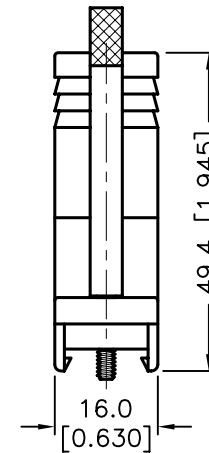
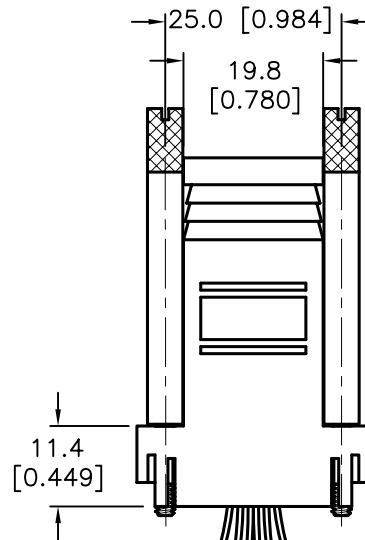
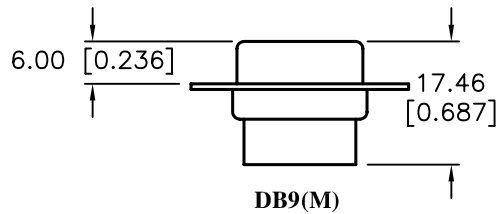

SPECIFICATIONS

- D-Sub Connector: Tin-Plated Shell with Black Color Insulator
- Contact:
 - D-Sub: Brass, Gold-Plated
 - RJ12: Brass, Gold-Plated
- Body: ABS, Ivory(Beige) Color
- Thumb Screw: Steel, Nickel-plated
- Electronic Wire: UL1061, 26 AWG

DISCLAIMER: ALL STATEMENTS AND TECHNICAL INFORMATION CONTAINED HEREIN ARE BASED UPON INFORMATION AND/OR TESTS WE BELIEVE TO BE ACCURATE AND RELIABLE. SINCE THE CONDITIONS OF USE ARE BEYOND OUR CONTROL, THE USER SHALL DETERMINE THE SUITABILITY OF THE PRODUCT FOR THE INTENDED USE AND ASSUME ALL RISK AND LIABILITY WHATSOEVER IN CONNECTION THEREWITH.

TOLERANCES:

Unless Otherwise Specified
 .X ±0.2 [0.008]
 .XX ±0.12 [0.005]

DRAWN BY:	DATE:
EKLAS ODISH	06/27/06
CHECKED BY:	DATE:
SAMI ALNADI	7/25/06
APPROVED BY:	DATE:
HISHAM ODISH	7/25/06

DRAWING TITLE: Telephone Adapter, DB9 Male to RJ12, 6 Conductors

SIZE	DWG. NO.	ELECTRONIC FILE	REV
A	SPC19786	84K8550.DWG	A
SCALE: NTS	U.O.M.: mm [INCHES]	SHEET: 1 OF 1	