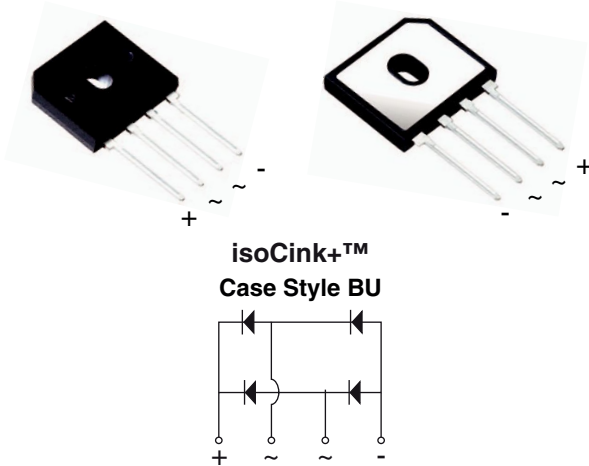


Enhanced isoCink+™ Bridge Rectifiers



* Tested to UL standard for safety electrically isolated semiconductor devices. UL 1557 4th edition. Dielectric tested to maximum case, storage and junction temperature to 150 °C to withstand 1500 V. Epoxy meets UL 94 V-0 flammability rating.

PRIMARY CHARACTERISTICS	
Package	BU
$I_{F(AV)}$	25 A
V_{RRM}	600 V, 800 V, 1000 V
I_{FSM}	300 A
I_R	5 μ A
V_F at $I_F = 12.5$ A	0.87 V
T_J max.	150 °C
Diode variations	In-Line

FEATURES

- UL recognition file number E309391 (QQQX2) UL 1557 (see *)
- Thin single in-line package
- Available for BU-5S lead forming option (part number with "5S" suffix, e.g. BU25065S)
- Superior thermal conductivity
- Solder dip 275 °C max. 10 s, per JESD 22-B106
- Material categorization: For definitions of compliance please see www.vishay.com/doc?99912


**RoHS
COMPLIANT**

TYPICAL APPLICATIONS

General purpose use in AC/DC bridge full wave rectification for switching power supply, home appliances and white-goods applications.

MECHANICAL DATA

Case: BU

Molding compound meets UL 94 V-0 flammability rating
Base P/N-E3 - RoHS-compliant, commercial grade

Terminals: Matte tin plated leads, solderable per J-STD-002 and JESD 22-B102

E3 suffix meets JESD 201 class 1A whisker test

Polarity: As marked on body

Mounting Torque: 10 cm-kg (8.8 inches-lbs) max.

Recommended Torque: 5.7 cm-kg (5 inches-lbs)

MAXIMUM RATINGS ($T_A = 25$ °C unless otherwise noted)					
PARAMETER	SYMBOL	BU2506	BU2508	BU2510	UNIT
Maximum repetitive peak reverse voltage	V_{RRM}	600	800	1000	V
Average rectified forward current (Fig. 1, 2)	I_O	$T_C = 60$ °C ⁽¹⁾		25	A
		$T_A = 25$ °C ⁽²⁾		3.5	
Non-repetitive peak forward surge current 8.3 ms single sine-wave, $T_J = 25$ °C	I_{FSM}			300	A
Rating for fusing ($t < 8.3$ ms) $T_J = 25$ °C	I^2t			373	A ² s
Operating junction and storage temperature range	T_J, T_{STG}			- 55 to + 150	°C

Notes

⁽¹⁾ With 60 W air cooled heatsink

⁽²⁾ Without heatsink, free air

ELECTRICAL CHARACTERISTICS ($T_A = 25\text{ }^\circ\text{C}$ unless otherwise noted)						
PARAMETER	TEST CONDITIONS	SYMBOL	TYP.	MAX.	UNIT	
Maximum instantaneous forward voltage per diode ⁽¹⁾	$I_F = 12.5\text{ A}$	$T_A = 25\text{ }^\circ\text{C}$	V_F	0.97	1.05	V
		$T_A = 125\text{ }^\circ\text{C}$		0.87		
Maximum reverse current per diode	rated V_R	$T_A = 25\text{ }^\circ\text{C}$	I_R	-	5.0	μA
		$T_A = 125\text{ }^\circ\text{C}$		120		
Typical junction capacitance per diode	4.0 V, 1 MHz	C_J	125	-	pF	

Note

⁽¹⁾ Pulse test: 300 μs pulse width, 1 % duty cycle

THERMAL CHARACTERISTICS ($T_A = 25\text{ }^\circ\text{C}$ unless otherwise noted)					
PARAMETER	SYMBOL	BU2506	BU2508	BU2510	UNIT
Typical thermal resistance	$R_{\theta JC}$ ⁽¹⁾	2.0			$^\circ\text{C/W}$
	$R_{\theta JA}$ ⁽²⁾	20			

Notes

⁽¹⁾ With 60 W air cooled heatsink

⁽²⁾ Without heatsink, free air

ORDERING INFORMATION (Example)				
PREFERRED P/N	UNIT WEIGHT (g)	PREFERRED PACKAGE CODE	BASE QUANTITY	DELIVERY MODE
BU2506-E3/45	4.84	45	20	Tube
BU2506-E3/51	4.84	51	250	Paper tray
BU25065S-E3/45	4.84	45	20	Tube

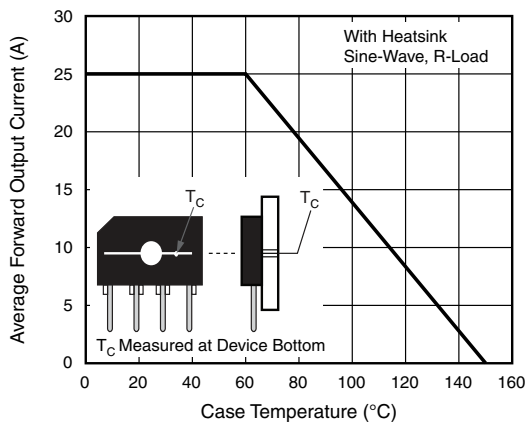
RATINGS AND CHARACTERISTICS CURVES ($T_A = 25\text{ }^\circ\text{C}$ unless otherwise specified)


Fig. 1 - Derating Curve Output Rectified Current

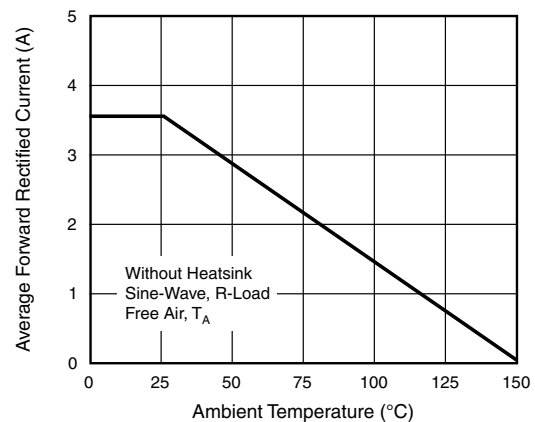


Fig. 2 - Forward Current Derating Curve

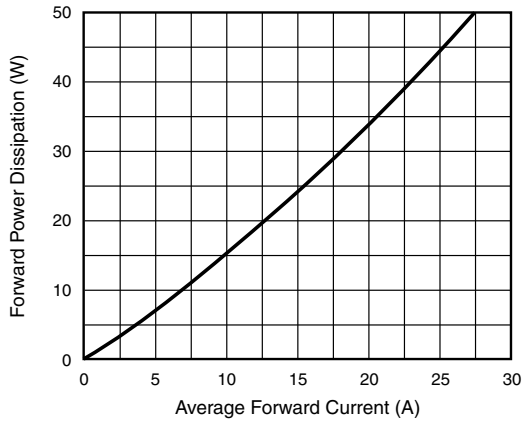


Fig. 3 - Forward Power Dissipation

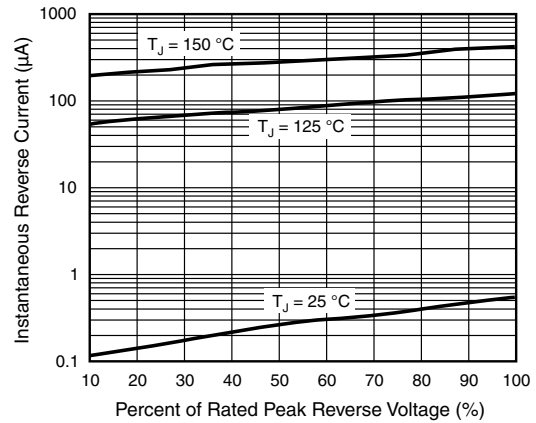


Fig. 5 - Typical Reverse Characteristics Per Diode

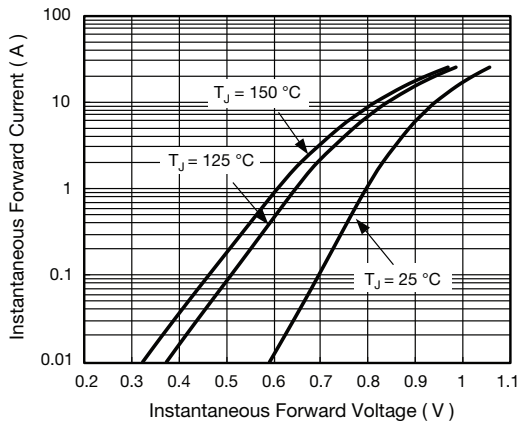


Fig. 4 - Typical Forward Characteristics Per Diode

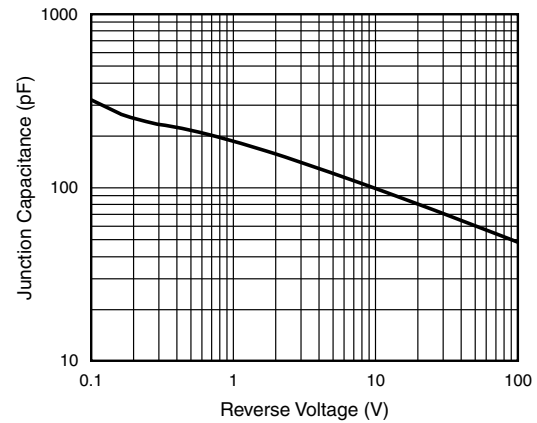
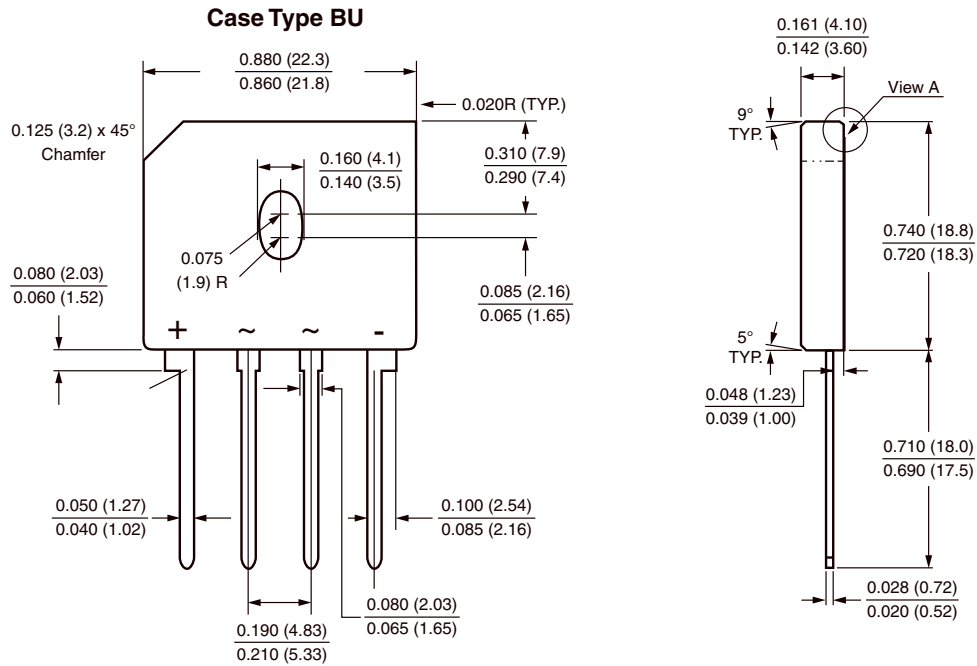


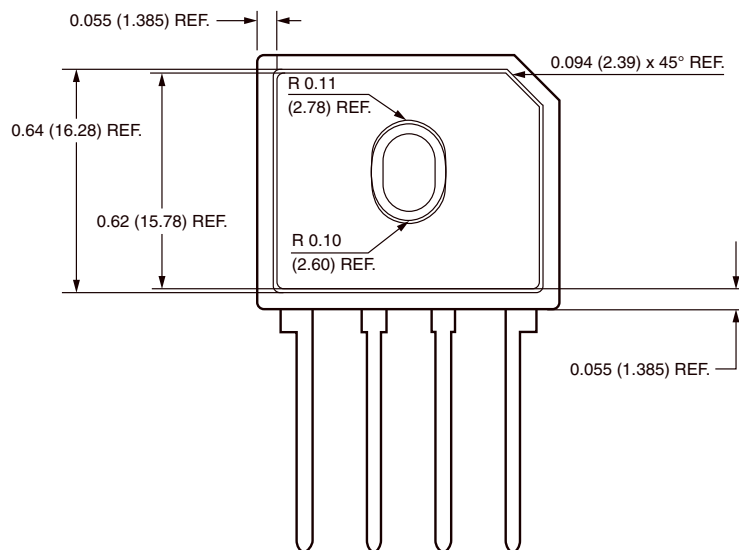
Fig. 6 - Typical Junction Capacitance Per Diode



PACKAGE OUTLINE DIMENSIONS in inches (millimeters)

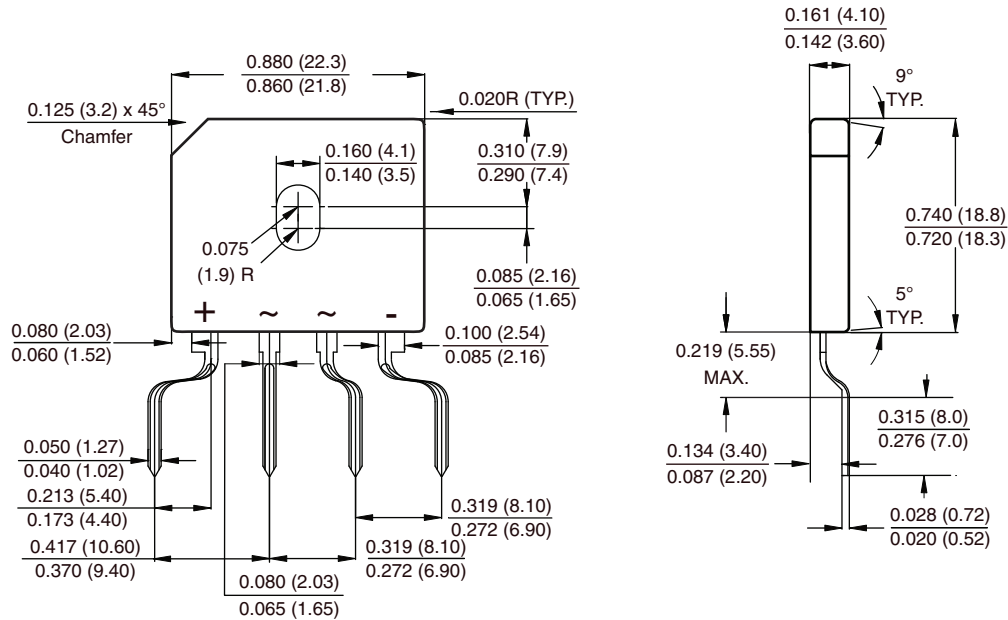


Polarity shown on front side of case, positive lead beveled corner



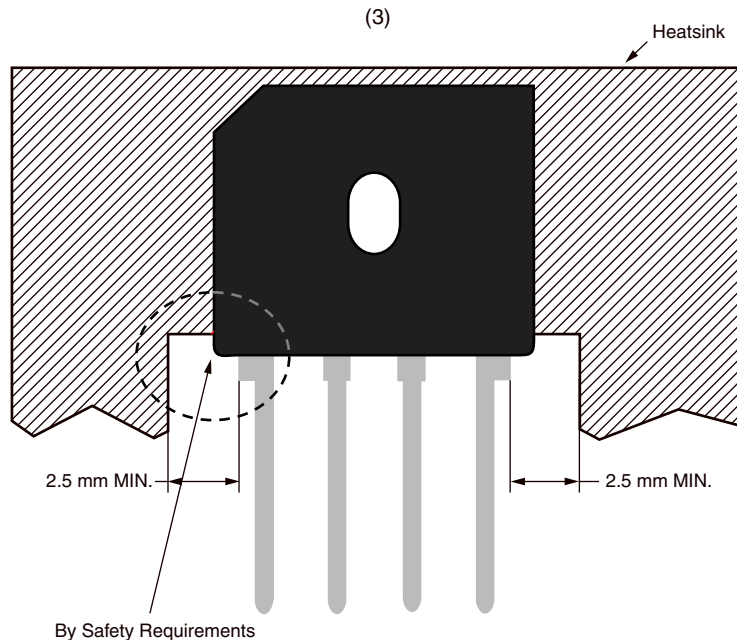


FORMING SPECIFICATION: BU-5S in inches (millimeters)



APPLICATION NOTE

- (1) Device UL approved for safety use dielectric strength of 1500 V.
- (2) If device is mounted in Floating Ground (F. G.) application, insulator is recommended to use to meet safety requirement.
- (3) Heat sink shape recommendation:





Disclaimer

ALL PRODUCT, PRODUCT SPECIFICATIONS AND DATA ARE SUBJECT TO CHANGE WITHOUT NOTICE TO IMPROVE RELIABILITY, FUNCTION OR DESIGN OR OTHERWISE.

Vishay Intertechnology, Inc., its affiliates, agents, and employees, and all persons acting on its or their behalf (collectively, "Vishay"), disclaim any and all liability for any errors, inaccuracies or incompleteness contained in any datasheet or in any other disclosure relating to any product.

Vishay makes no warranty, representation or guarantee regarding the suitability of the products for any particular purpose or the continuing production of any product. To the maximum extent permitted by applicable law, Vishay disclaims (i) any and all liability arising out of the application or use of any product, (ii) any and all liability, including without limitation special, consequential or incidental damages, and (iii) any and all implied warranties, including warranties of fitness for particular purpose, non-infringement and merchantability.

Statements regarding the suitability of products for certain types of applications are based on Vishay's knowledge of typical requirements that are often placed on Vishay products in generic applications. Such statements are not binding statements about the suitability of products for a particular application. It is the customer's responsibility to validate that a particular product with the properties described in the product specification is suitable for use in a particular application. Parameters provided in datasheets and/or specifications may vary in different applications and performance may vary over time. All operating parameters, including typical parameters, must be validated for each customer application by the customer's technical experts. Product specifications do not expand or otherwise modify Vishay's terms and conditions of purchase, including but not limited to the warranty expressed therein.

Except as expressly indicated in writing, Vishay products are not designed for use in medical, life-saving, or life-sustaining applications or for any other application in which the failure of the Vishay product could result in personal injury or death. Customers using or selling Vishay products not expressly indicated for use in such applications do so at their own risk. Please contact authorized Vishay personnel to obtain written terms and conditions regarding products designed for such applications.

No license, express or implied, by estoppel or otherwise, to any intellectual property rights is granted by this document or by any conduct of Vishay. Product names and markings noted herein may be trademarks of their respective owners.

Material Category Policy

Vishay Intertechnology, Inc. hereby certifies that all its products that are identified as RoHS-Compliant fulfill the definitions and restrictions defined under Directive 2011/65/EU of The European Parliament and of the Council of June 8, 2011 on the restriction of the use of certain hazardous substances in electrical and electronic equipment (EEE) - recast, unless otherwise specified as non-compliant.

Please note that some Vishay documentation may still make reference to RoHS Directive 2002/95/EC. We confirm that all the products identified as being compliant to Directive 2002/95/EC conform to Directive 2011/65/EU.

Vishay Intertechnology, Inc. hereby certifies that all its products that are identified as Halogen-Free follow Halogen-Free requirements as per JEDEC JS709A standards. Please note that some Vishay documentation may still make reference to the IEC 61249-2-21 definition. We confirm that all the products identified as being compliant to IEC 61249-2-21 conform to JEDEC JS709A standards.