

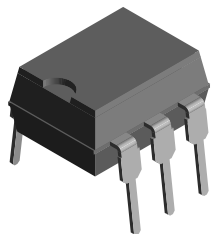

Optocoupler, Phototransistor Output, with Base Connection

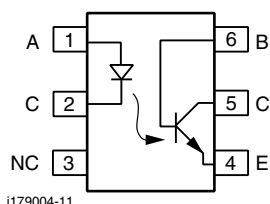

i179004-3



i179004-11

RoHS
COMPLIANT

FEATURES

- Isolation test voltage (1.0 s), 5300 V_{RMS}
- V_{CEsat} 0.25 (≤ 0.4) V, I_F = 10 mA, I_C = 2.5 mA
- Built to conform to VDE requirements
- Highest quality premium device
- Long term stability
- Storage temperature, - 55 ° to + 150 °C
- Material categorization: For definitions of compliance please see www.vishay.com/doc?99912

DESCRIPTION

The SFH601 is an optocoupler with a gallium arsenide LED emitter which is optically coupled with a silicon planar phototransistor detector. The component is packaged in a plastic plug-in case 20 AB DIN 41866.

The coupler transmits signals between two electrically isolated circuits.

AGENCY APPROVALS

- UL1577, file no. E52744 system code H or J, double protection
- DIN EN 60747-5-5 (VDE 0884-5) available with option 1
- CSA 93751
- BSI IEC 60950; IEC 60065

ORDERING INFORMATION

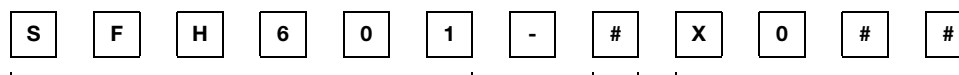

PART NUMBER

CTR
BIN

PACKAGE OPTION

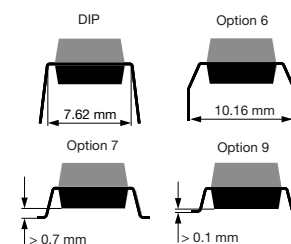

AGENCY CERTIFIED/PACKAGE	CTR (%)			
	40 to 80	63 to 125	100 to 200	160 to 320
UL, BSI, CSA				
DIP-6	SFH601-1	SFH601-2	SFH601-3	SFH601-4
DIP-6, 400 mil, option 6	SFH601-1X006	SFH601-2X006	SFH601-3X006	SFH601-4X006
SMD-6, option 7	SFH601-1X007	SFH601-2X007T	SFH601-3X007(T)	SFH601-4X007(T)
SMD-6, option 9	SFH601-1X009T	SFH601-2X009	SFH601-3X009	SFH601-4X009(T)
VDE, cUL, UL, BSI				
DIP-6, option 1	SFH601-1X001	SFH601-2X001	-	SFH601-4X001
DIP-6, 400 mil, option 6	SFH601-1X016	-	SFH601-3X016	SFH601-4X016
SMD-6, option 7	SFH601-1X017	SFH601-2X017(T)	SFH601-3X017(T)	-
SMD-6, option 9	-	-	SFH601-3X019(T)	-

Note

- For additional information on the available options refer to option information.

ABSOLUTE MAXIMUM RATINGS (T_{amb} = 25 °C, unless otherwise specified)

PARAMETER	TEST CONDITION	SYMBOL	VALUE	UNIT
INPUT				
Reverse voltage		V _R	6	V
DC forward current		I _F	60	mA
Surge forward current	t = 10 μs	I _{FSM}	2.5	A
Total power dissipation		P _{diss}	100	mW



ABSOLUTE MAXIMUM RATINGS ($T_{amb} = 25\text{ }^{\circ}\text{C}$, unless otherwise specified)				
PARAMETER	TEST CONDITION	SYMBOL	VALUE	UNIT
OUTPUT				
Collector emitter voltage		V_{CEO}	100	V
Emitter base voltage		V_{EBO}	7	V
Collector current		I_C	50	mA
	$t = 1.0\text{ ms}$	I_C	100	mA
Power dissipation		P_{diss}	150	mW
COUPLER				
Isolation test voltage between emitter and detector	$t = 1.0\text{ s}$	V_{ISO}	5300	V_{RMS}
Isolation resistance	$V_{IO} = 500\text{ V}, T_{amb} = 25\text{ }^{\circ}\text{C}$	R_{IO}	$\geq 10^{12}$	Ω
	$V_{IO} = 500\text{ V}, T_{amb} = 100\text{ }^{\circ}\text{C}$	R_{IO}	$\geq 10^{11}$	Ω
Storage temperature range		T_{stg}	- 55 to + 150	$^{\circ}\text{C}$
Ambient temperature range		T_{amb}	- 55 to +100	$^{\circ}\text{C}$
Junction temperature		T_j	100	$^{\circ}\text{C}$
Soldering temperature ⁽¹⁾	max. 10 s, dip soldering: distance to seating plane $\geq 1.5\text{ mm}$	T_{sld}	260	$^{\circ}\text{C}$

Notes

- Stresses in excess of the absolute maximum ratings can cause permanent damage to the device. Functional operation of the device is not implied at these or any other conditions in excess of those given in the operational sections of this document. Exposure to absolute maximum ratings for extended periods of the time can adversely affect reliability.

⁽¹⁾ Refer to reflow profile for soldering conditions for surface mounted devices (SMD). Refer to wave profile for soldering conditions for through hole devices (DIP).

ELECTRICAL CHARACTERISTICS ($T_{amb} = 25\text{ }^{\circ}\text{C}$, unless otherwise specified)							
PARAMETER	TEST CONDITION	PART	SYMBOL	MIN.	TYP.	MAX.	UNIT
INPUT							
Forward voltage	$I_F = 60\text{ mA}$		V_F		1.25	1.65	V
Breakdown voltage	$I_R = 10\text{ }\mu\text{A}$		V_{BR}	6			V
Reverse current	$V_R = 6\text{ V}$		I_R		0.01	10	μA
Capacitance	$V_F = 0\text{ V}, f = 1\text{ MHz}$		C_O		25		pF
Thermal resistance			R_{thja}		750		K/W
OUTPUT							
Collector emitter capacitance	$f = 1\text{ MHz}, V_{CE} = 5\text{ V}$		C_{CE}		6.8		pF
Collector base capacitance	$f = 1\text{ MHz}, V_{CB} = 5\text{ V}$		C_{CB}		8.5		pF
Emitter base capacitance	$f = 1\text{ MHz}, V_{EB} = 5\text{ V}$		C_{EB}		11		pF
Thermal resistance			R_{thja}		500		K/W
Collector emitter leakage current	$V_{CE} = 10\text{ V}$	SFH601-1	I_{CEO}		2	50	nA
		SFH601-2	I_{CEO}		2	50	nA
		SFH601-3	I_{CEO}		5	100	nA
		SFH601-4	I_{CEO}		5	100	nA
COUPLER							
Saturation voltage collector emitter	$I_F = 10\text{ mA}, I_C = 2.5\text{ mA}$		V_{CEsat}		0.25	0.4	V
Capacitance (input to output)	$V_{I-O} = 0, f = 1\text{ MHz}$		C_{IO}		0.6		pF

Note

- Minimum and maximum values are testing requirements. Typical values are characteristics of the device and are the result of engineering evaluation. Typical values are for information only and are not part of the testing requirements.



CURRENT TRANSFER RATIO							
PARAMETER	TEST CONDITION	PART	SYMBOL	MIN.	TYP.	MAX.	UNIT
I_C/I_F at $V_{CE} = 5.0\text{ V}$	$I_F = 10\text{ mA}$	SFH601-1	CTR	40		80	%
		SFH601-2	CTR	63		125	%
		SFH601-3	CTR	100		200	%
		SFH601-4	CTR	160		320	%
	$I_F = 1\text{ mA}$	SFH601-1	CTR	13	30		%
		SFH601-2	CTR	22	45		%
		SFH601-3	CTR	34	70		%
		SFH601-4	CTR	56	90		%

Note

- Current transfer ratio and collector emitter leakage current by dash number.

SWITCHING CHARACTERISTICS							
PARAMETER	TEST CONDITION	PART	SYMBOL	MIN.	TYP.	MAX.	UNIT
NON-SATURATED							
Current	$V_{CC} = 5\text{ V}, R_L = 75\ \Omega$		I_F		10		mA
Rise time	$V_{CC} = 5\text{ V}, R_L = 75\ \Omega$		t_r		2		μs
Fall time	$V_{CC} = 5\text{ V}, R_L = 75\ \Omega$		t_f		2		μs
Turn-on time	$V_{CC} = 5\text{ V}, R_L = 75\ \Omega$		t_{on}		3		μs
Turn-off time	$V_{CC} = 5\text{ V}, R_L = 75\ \Omega$		t_{off}		2.3		μs
SATURATED							
Current		SFH601-1	I_F		20		mA
		SFH601-2	I_F		10		mA
		SFH601-3	I_F		10		mA
		SFH601-4	I_F		0.5		mA
Rise time		SFH601-1	t_r		2		μs
		SFH601-2	t_r		3		μs
		SFH601-3	t_r		3		μs
		SFH601-4	t_r		4.6		μs
Fall time		SFH601-1	t_f		11		μs
		SFH601-2	t_f		14		μs
		SFH601-3	t_f		14		μs
		SFH601-4	t_f		15		μs
Turn-on time		SFH601-1	t_{on}		3		μs
		SFH601-2	t_{on}		4.2		μs
		SFH601-3	t_{on}		4.2		μs
		SFH601-4	t_{on}		6		μs
Turn-off time		SFH601-1	t_{off}		18		μs
		SFH601-2	t_{off}		23		μs
		SFH601-3	t_{off}		23		μs
		SFH601-4	t_{off}		25		μs

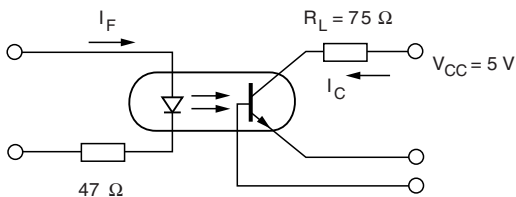

isth601_01

Fig. 1 - Linear Operation (without Saturation)

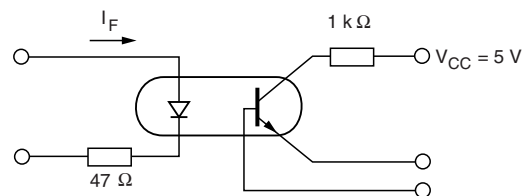

isth601_02

Fig. 2 - Switching Operation (with Saturation)



SAFETY AND INSULATION RATINGS						
PARAMETER	TEST CONDITION	SYMBOL	MIN.	TYP.	MAX.	UNIT
Climatic classification	according to IEC 68 part 1			55/100/21		
Comparative tracking index		CTI	175		399	
V _{IOTM}			8000			V
V _{IORM}			890			V
P _{SO}					700	mW
I _{SI}					400	mA
T _{SI}					175	°C
Creepage distance	standard DIP-6		7			mm
Clearance distance	standard DIP-6		7			mm
Creepage distance	400 mil DIP-6		8			mm
Clearance distance	400 mil DIP-6		8			mm
Insulation thickness, reinforced rated	per IEC 60950 2.10.5.1		0.4			mm

Note

- As per IEC 60747-5-2, § 7.4.3.8.1, this optocoupler is suitable for “safe electrical insulation” only within the safety ratings. Compliance with the safety ratings shall be ensured by means of protective circuits.

TYPICAL CHARACTERISTICS (T_{amb} = 25 °C, unless otherwise specified)

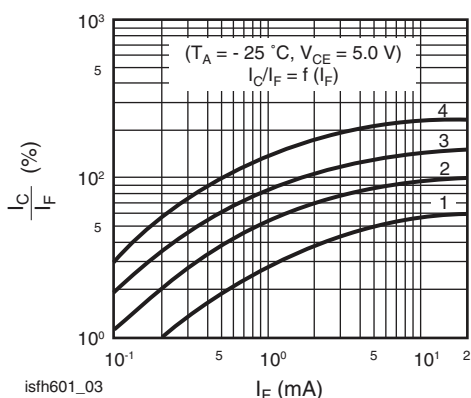

Fig. 3 - Current Transfer Ratio vs. Diode Current

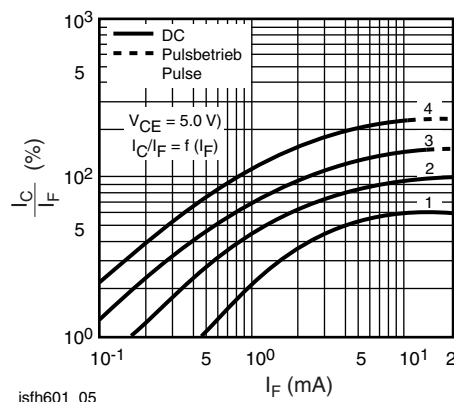

Fig. 5 - Current Transfer Ratio vs. Diode Current

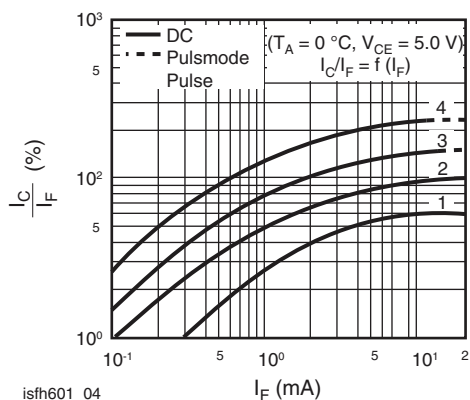

Fig. 4 - Current Transfer Ratio vs. Diode Current

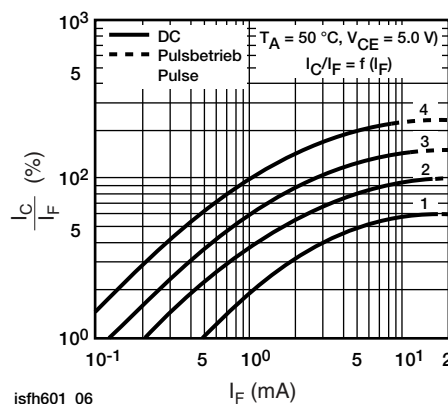

Fig. 6 - Current Transfer Ratio vs. Diode Current

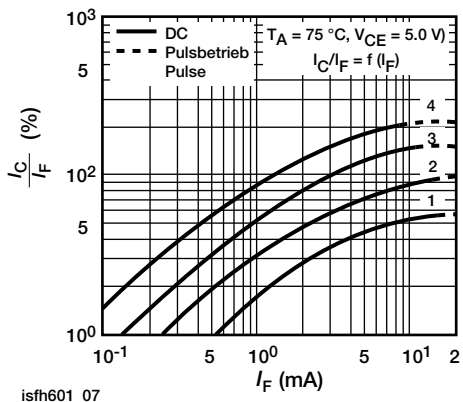

Fig. 7 - Current Transfer Ratio vs. Diode Current

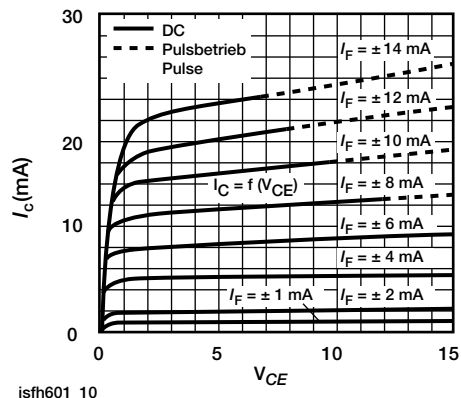

Fig. 10 - Output Characteristics

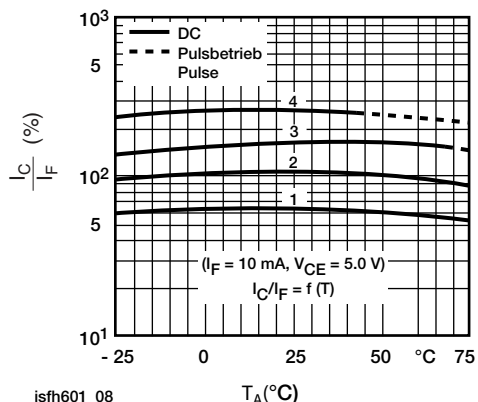

Fig. 8 - Current Transfer Ratio vs. Diode Current

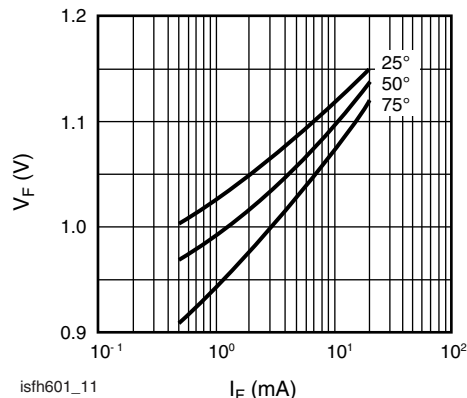

Fig. 11 - Forward Voltage

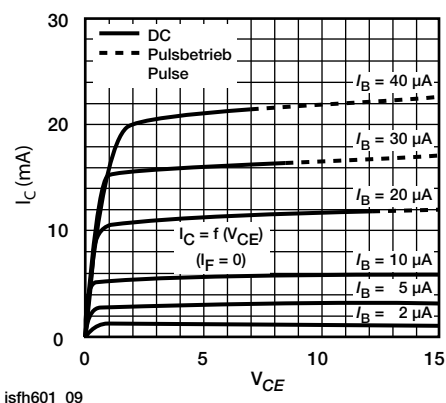

Fig. 9 - Transistor Characteristics

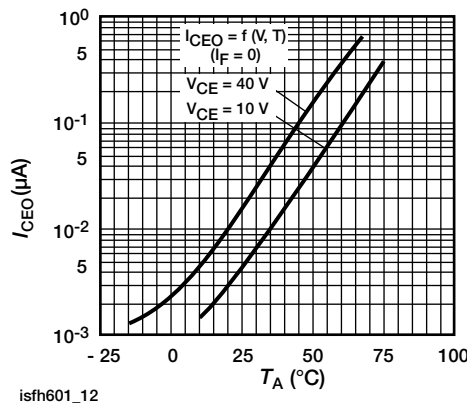

Fig. 12 - Collector Emitter Off-state Current

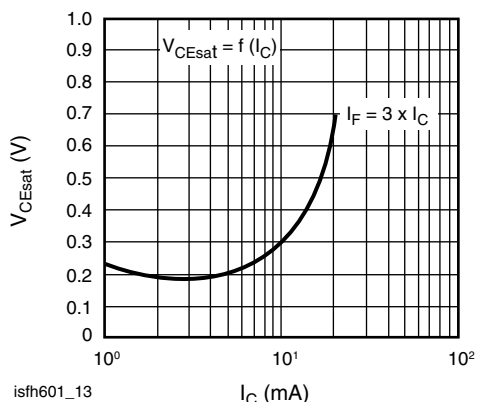

Fig. 13 - Saturation Voltage vs. Collector Current and Modulation Depth SFH601-1

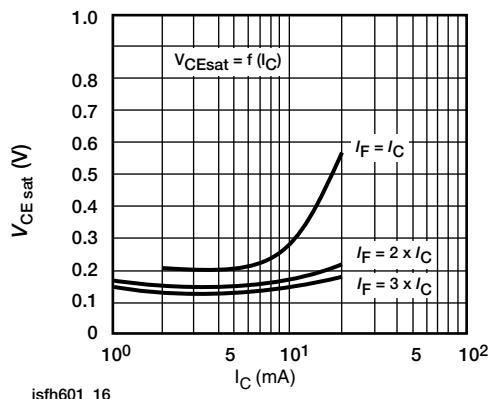

Fig. 16 - Saturation Voltage vs. Collector Current and Modulation Depth SFH601-4

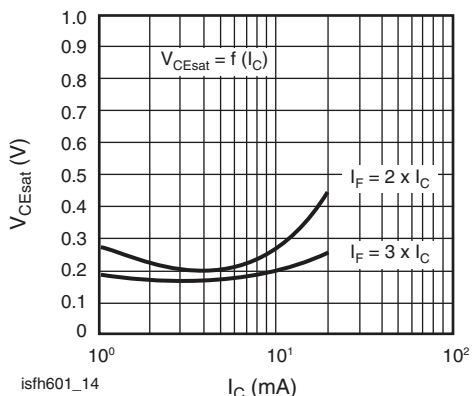

Fig. 14 - Saturation Voltage vs. Collector Current and Modulation Depth SFH601-2

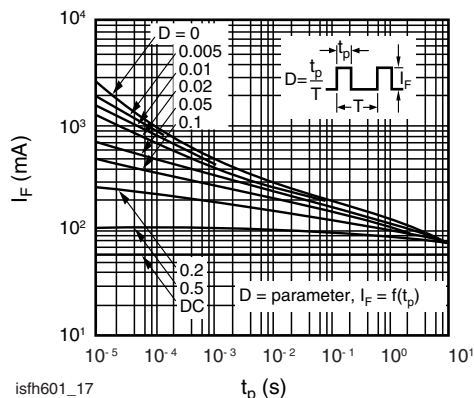

Fig. 17 - Permissible Pulse Load

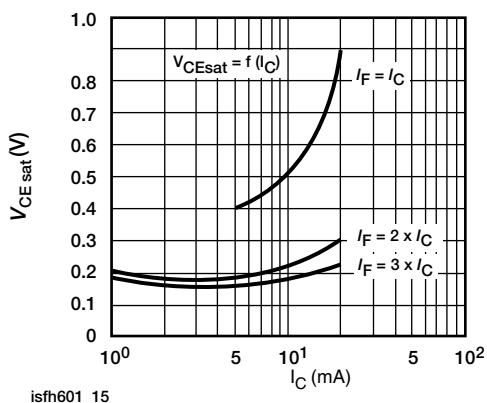

Fig. 15 - Saturation Voltage vs. Collector Current and Modulation Depth SFH601-3

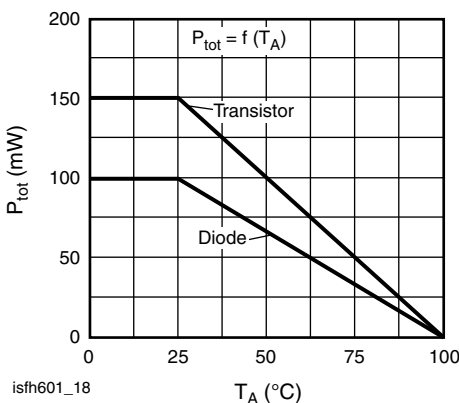
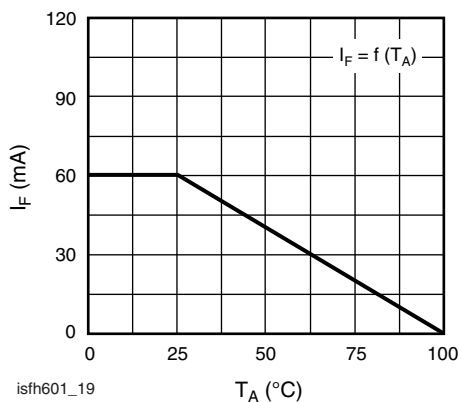
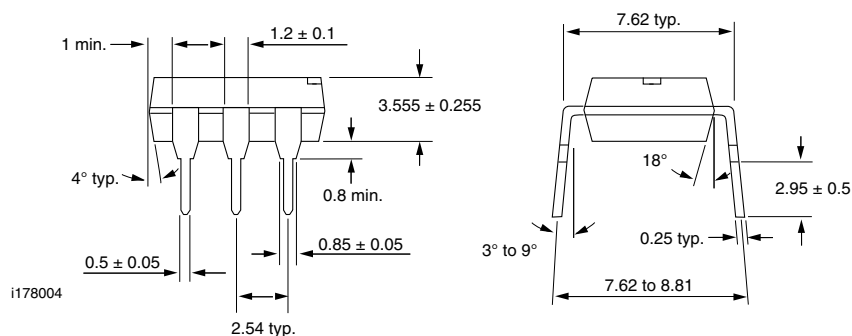
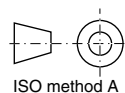
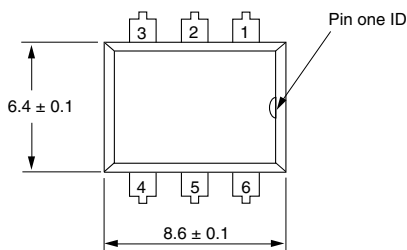

Fig. 18 - Permissible Power Dissipation for Transistor and Diode



isfh601_19
Fig. 19 - Permissible Forward Current Diode

PACKAGE DIMENSIONS in inches (millimeters)



Option 6

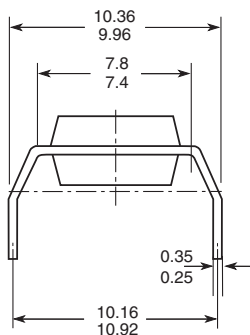

Option 7

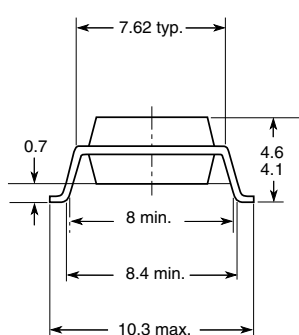

Option 9

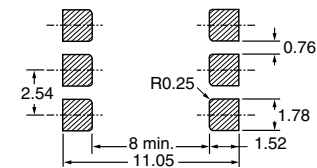
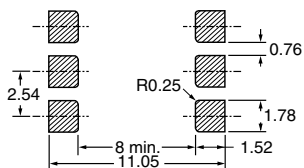
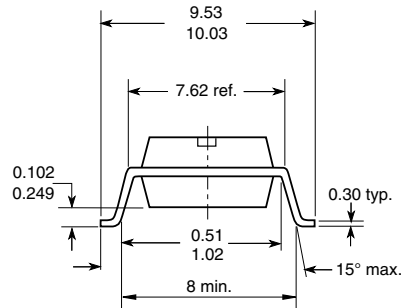

18450-16



DIP-6A

Package Dimensions in Inches (mm)

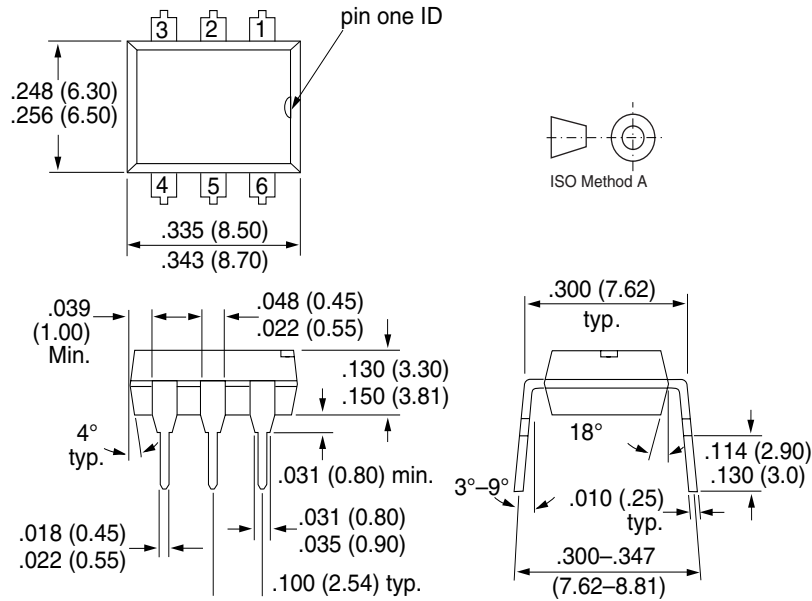

i178004

Ozone Depleting Substances Policy Statement

It is the policy of **Vishay Semiconductor GmbH** to

1. Meet all present and future national and international statutory requirements.
2. Regularly and continuously improve the performance of our products, processes, distribution and operating systems with respect to their impact on the health and safety of our employees and the public, as well as their impact on the environment.

It is particular concern to control or eliminate releases of those substances into the atmosphere which are known as ozone depleting substances (ODSs).

The Montreal Protocol (1987) and its London Amendments (1990) intend to severely restrict the use of ODSs and forbid their use within the next ten years. Various national and international initiatives are pressing for an earlier ban on these substances.

Vishay Semiconductor GmbH has been able to use its policy of continuous improvements to eliminate the use of ODSs listed in the following documents.

1. Annex A, B and list of transitional substances of the Montreal Protocol and the London Amendments respectively
2. Class I and II ozone depleting substances in the Clean Air Act Amendments of 1990 by the Environmental Protection Agency (EPA) in the USA
3. Council Decision 88/540/EEC and 91/690/EEC Annex A, B and C (transitional substances) respectively.

Vishay Semiconductor GmbH can certify that our semiconductors are not manufactured with ozone depleting substances and do not contain such substances.

**We reserve the right to make changes to improve technical design
and may do so without further notice.**

Parameters can vary in different applications. All operating parameters must be validated for each customer application by the customer. Should the buyer use Vishay Semiconductors products for any unintended or unauthorized application, the buyer shall indemnify Vishay Semiconductors against all claims, costs, damages, and expenses, arising out of, directly or indirectly, any claim of personal damage, injury or death associated with such unintended or unauthorized use.

Vishay Semiconductor GmbH, P.O.B. 3535, D-74025 Heilbronn, Germany
Telephone: 49 (0)7131 67 2831, Fax number: 49 (0)7131 67 2423



Disclaimer

ALL PRODUCT, PRODUCT SPECIFICATIONS AND DATA ARE SUBJECT TO CHANGE WITHOUT NOTICE TO IMPROVE RELIABILITY, FUNCTION OR DESIGN OR OTHERWISE.

Vishay Intertechnology, Inc., its affiliates, agents, and employees, and all persons acting on its or their behalf (collectively, "Vishay"), disclaim any and all liability for any errors, inaccuracies or incompleteness contained in any datasheet or in any other disclosure relating to any product.

Vishay makes no warranty, representation or guarantee regarding the suitability of the products for any particular purpose or the continuing production of any product. To the maximum extent permitted by applicable law, Vishay disclaims (i) any and all liability arising out of the application or use of any product, (ii) any and all liability, including without limitation special, consequential or incidental damages, and (iii) any and all implied warranties, including warranties of fitness for particular purpose, non-infringement and merchantability.

Statements regarding the suitability of products for certain types of applications are based on Vishay's knowledge of typical requirements that are often placed on Vishay products in generic applications. Such statements are not binding statements about the suitability of products for a particular application. It is the customer's responsibility to validate that a particular product with the properties described in the product specification is suitable for use in a particular application. Parameters provided in datasheets and/or specifications may vary in different applications and performance may vary over time. All operating parameters, including typical parameters, must be validated for each customer application by the customer's technical experts. Product specifications do not expand or otherwise modify Vishay's terms and conditions of purchase, including but not limited to the warranty expressed therein.

Except as expressly indicated in writing, Vishay products are not designed for use in medical, life-saving, or life-sustaining applications or for any other application in which the failure of the Vishay product could result in personal injury or death. Customers using or selling Vishay products not expressly indicated for use in such applications do so at their own risk. Please contact authorized Vishay personnel to obtain written terms and conditions regarding products designed for such applications.

No license, express or implied, by estoppel or otherwise, to any intellectual property rights is granted by this document or by any conduct of Vishay. Product names and markings noted herein may be trademarks of their respective owners.

Material Category Policy

Vishay Intertechnology, Inc. hereby certifies that all its products that are identified as RoHS-Compliant fulfill the definitions and restrictions defined under Directive 2011/65/EU of The European Parliament and of the Council of June 8, 2011 on the restriction of the use of certain hazardous substances in electrical and electronic equipment (EEE) - recast, unless otherwise specified as non-compliant.

Please note that some Vishay documentation may still make reference to RoHS Directive 2002/95/EC. We confirm that all the products identified as being compliant to Directive 2002/95/EC conform to Directive 2011/65/EU.

Vishay Intertechnology, Inc. hereby certifies that all its products that are identified as Halogen-Free follow Halogen-Free requirements as per JEDEC JS709A standards. Please note that some Vishay documentation may still make reference to the IEC 61249-2-21 definition. We confirm that all the products identified as being compliant to IEC 61249-2-21 conform to JEDEC JS709A standards.