

Cree® PLCC4 3 in 1 RGB SMD LED CLMVB-FKA



PRODUCT DESCRIPTION

The CLMVB-FKA full-color RGB LED offers a high-intensity light output and a wide viewing angle. The compact 2mm x 2mm package allows for a very high resolution screen and is designed to work in a wide array of environmental conditions. Cree PLCC full-color RGB LEDs are suited for indoor video screen, decorative lighting and amusement applications.

FEATURES

- Size (mm): 2.0x 2.0
- Dominant Wavelength:
Red (619 - 624nm)
Green (520 - 540nm)
Blue (460 - 480nm)
- Luminous Intensity (mcd)
Red (224 - 450)@ 20mA
Green (180 - 450)@10mA
Blue (56 - 140)@ 10mA
- Lead-Free
- RoHS Compliant

APPLICATIONS

- Full-Color Video Screen
- Decorative lighting
- Amusement

ABSOLUTE MAXIMUM RATINGS ($T_A = 25^\circ\text{C}$)

Items	Symbol	Absolute Maximum Rating			Unit
		R	G	B	
Forward Current ^{Note 1}	I_F	25	17	17	mA
Peak Forward Current ^{Note 2}	I_{FP}	100	70	70	mA
Reverse Voltage	V_R	5	5	5	V
Power Dissipation	P_D	65	65	65	mW
Operation Temperature	T_{opr}	-40 ~ +100			$^\circ\text{C}$
Storage Temperature	T_{stg}	-40 ~ +100			$^\circ\text{C}$
Junction Temperature	T_j	110	110	110	$^\circ\text{C}$
Junction/ambient 1 chip on	R_{THJA}	450	400	450	$^\circ\text{C}/\text{W}$
Junction/ambient 3 chips on	R_{THJA}	650	580	680	$^\circ\text{C}/\text{W}$
Junction/solder point 1 chip on	R_{THJS}	300	280	300	$^\circ\text{C}/\text{W}$
Junction/solder point 3 chips on	R_{THJS}	450	430	480	$^\circ\text{C}/\text{W}$

Note: 1.Single-color light.
2.Pulse width ≤ 0.1 msec, duty $\leq 1/10$.

TYPICAL ELECTRICAL & OPTICAL CHARACTERISTICS ($T_A = 25^\circ\text{C}$)

Characteristics	Condition	Symbol	Values			Unit
			R	G	B	
Dominant Wavelength	$I_F = 20 \text{ mA(R)}$ $I_F = 10 \text{ mA(B,G)}$	λ_{DOM}	619~624	520~540	460~480	nm
Spectral bandwidth at 50% I_{REL} max	$I_F = 20 \text{ mA(R)}$ $I_F = 10 \text{ mA(B,G)}$	$\Delta \lambda$	24	38	28	nm
Viewing Angle at 50% I_V	$I_F = 20 \text{ mA(R)}$ $I_F = 10 \text{ mA(B,G)}$	$2\theta_{1/2}$	110	110	110	deg
Forward Voltage	$I_F = 20 \text{ mA(R)}$ $I_F = 10 \text{ mA(B,G)}$	$V_{F(avg)}$	2.0	3.0	3.0	V
		$V_{F(max)}$	2.6	3.8	3.8	V
Luminous Intensity	$I_F = 20 \text{ mA(R)}$ $I_F = 10 \text{ mA(B,G)}$	$I_{V(min)}$	224	180	56	mcd
		$I_{V(avg)}$	280	260	81	mcd
Reverse Current (max)	$V_R = 5 \text{ V}$	I_R	10	10	10	μA

INTENSITY BIN LIMIT (RED $I_F = 20$ mA, GREEN & BLUE $I_F = 10$ mA)

Red

Bin Code	Min.(mcd)	Max.(mcd)
F	224	280
de	252	318
G	280	355
fg	318	403
H	355	450

Green

Bin Code	Min.(mcd)	Max.(mcd)
E	180	224
bc	202	252
F	224	280
de	252	318
G	280	355
fg	318	403
H	355	450

Blue

Bin Code	Min.(mcd)	Max.(mcd)
L	56	71
3c3b	64	81
A	71	90
3a4	81	101
B	90	112
56	101	126
C	112	140

Tolerance of measurement of luminous intensity is $\pm 10\%$.

COLOR BIN LIMIT (RED $I_F = 20$ mA, GREEN & BLUE $I_F = 10$ mA)

Red

Bin Code	Min.(nm)	Max.(nm)
RB	619	624

Green

Bin Code	Min.(nm)	Max.(nm)
G7	520	525
G23	522.5	527.5
G8	525	530
G45	527.5	532.5
G9	530	535
G67	532.5	537.5
Ga	535	540

Blue

Bin Code	Min.(nm)	Max.(nm)
B3	460	465
B23	462.5	467.5
B4	465	470
B45	467.5	472.5
B5	470	475
B67	472.5	477.5
B6	475	480

Tolerance of measurement of dominant wavelength is ± 1 nm.

ORDER CODE TABLE*

Kit Number	Color	Luminous Intensity (mcd)		Dominant Wavelength (nm)				Package
		Min.	Max.	Color Bin	Min. (nm)	Color Bin	Max. (nm)	
CLMVB-FKA-CFHEHLCBB7a363	Red	224	450	RB	619	RB	624	Reel
	Green	180	450	G7	520	Ga	540	Reel
	Blue	56	140	B3	460	B6	480	Reel
CLMVB-FKA-CF1E1L1BB7R3R3	Red	Any 1 Intensity bin from F(224) - G(355)		RB	619	RB	624	Reel
	Green	Any 1 Intensity bin from E(180) - G(355)		Any 1 hue bin from G7(520) - Ga(540)				Reel
	Blue	Any 1 Intensity bin from L(56) - B(112)		Any 1 hue bin from B3(460) - B6(480)				Reel
CLMVB-FKA-CG1F1A1BB8S3S3	Red	Any 1 Intensity bin from G(355) - H(450)		RB	619	RB	624	Reel
	Green	Any 1 Intensity bin from F(224) - H(450)		Any 1 hue bin from G8(525) - Ga(540)				Reel
	Blue	Any 1 Intensity bin from A(71) - C(140)		Any 1 hue bin from B3(460) - B5(475)				Reel

Notes:

1. The above kit numbers represent the order codes which include multiple intensity-bin and color-bin codes. Only one intensity-bin code and one color-bin code will be shipped on each reel. Single intensity-bin code and single color-bin code will be orderable in certain quantities.
2. For example, any 1 intensity-bin from F - H means only 1 intensity-bin (F or G or H) will be shipped by Cree.
3. For example, any 1 color-bin from G7 - Ga means only 1 color-bin (G7 or G8 or G9 or Ga) will be shipped by Cree.
4. Please refer to the "Cree LED Lamp Reliability Test Standards" document for reliability test conditions.
5. Please refer to the "Cree LED Lamp Soldering & Handling" document for information about how to use this LED product safely.

GRAPHS

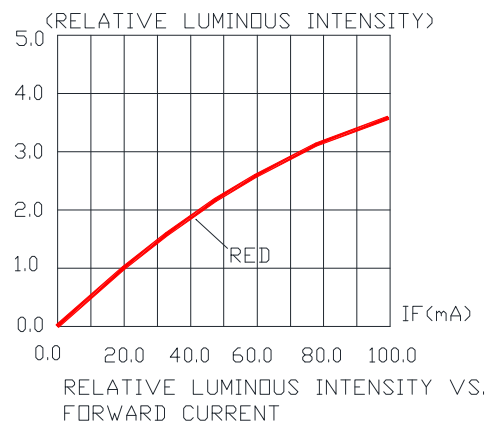
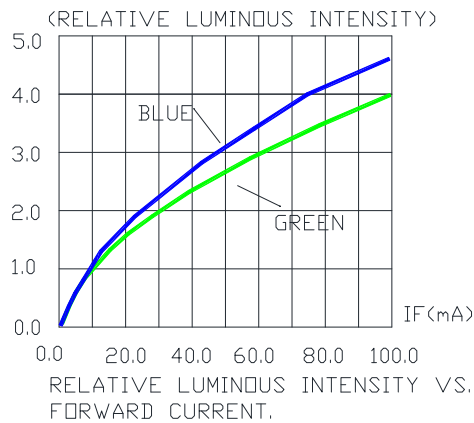
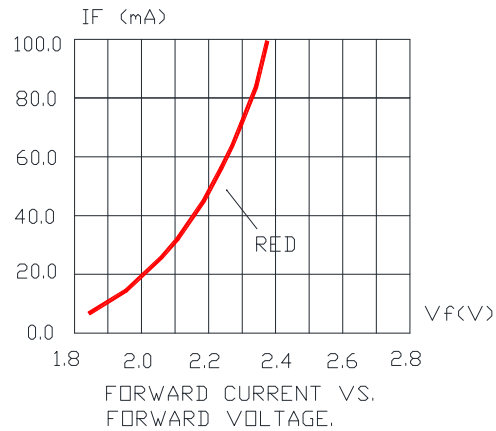
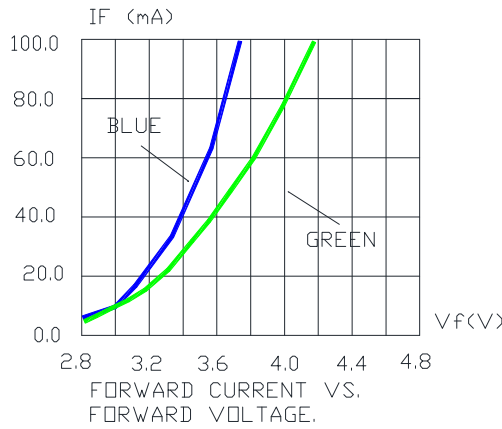
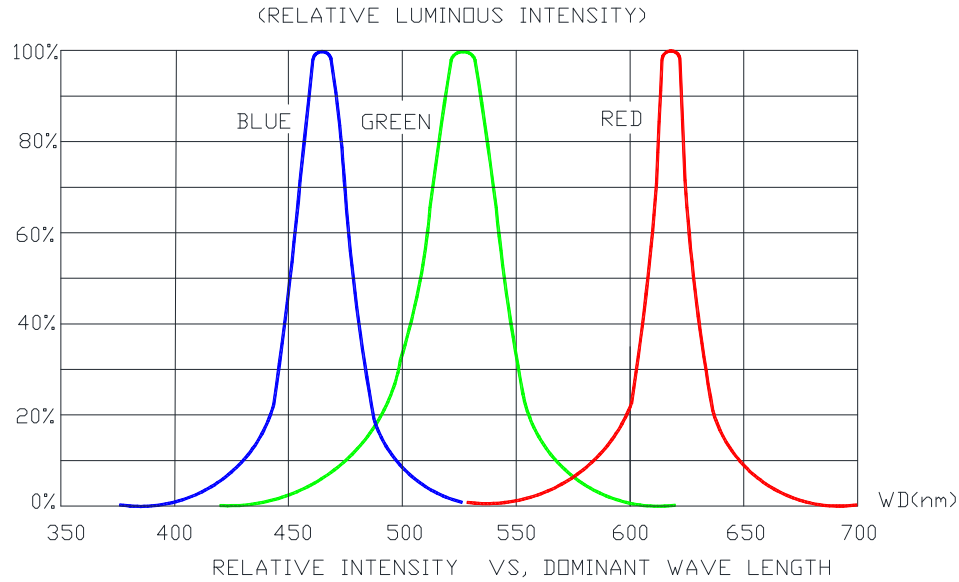

The above data are collected from statistical figures that do not necessarily correspond to the actual parameters of each single LED. Hence, these data will be changed without further notice.

GRAPHS

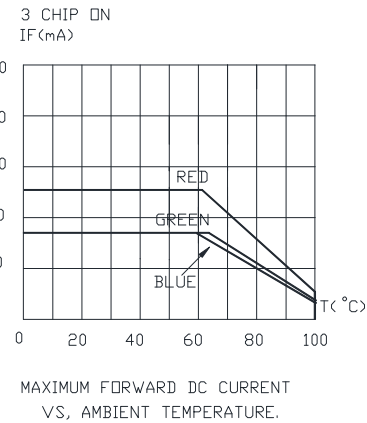
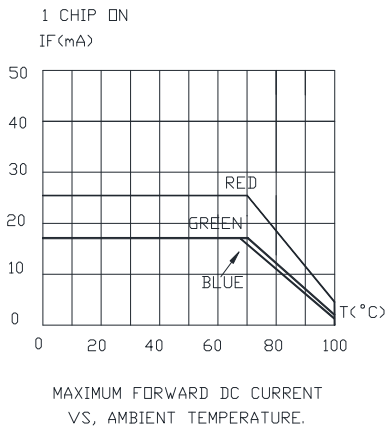
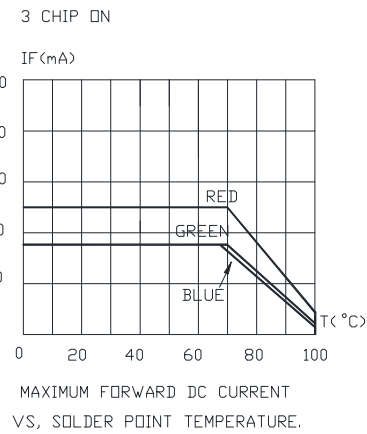
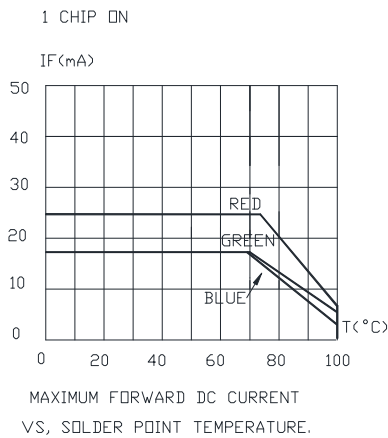
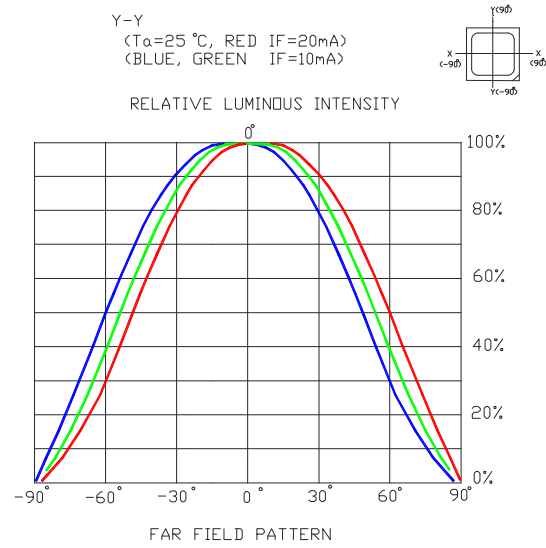
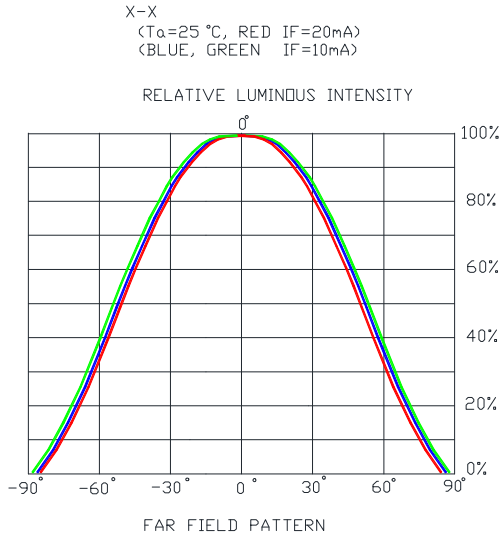

The above data are collected from statistical figures that do not necessarily correspond to the actual parameters of each single LED. Hence, these data will be changed without further notice.

MECHANICAL DIMENSIONS

All dimensions are in mm.

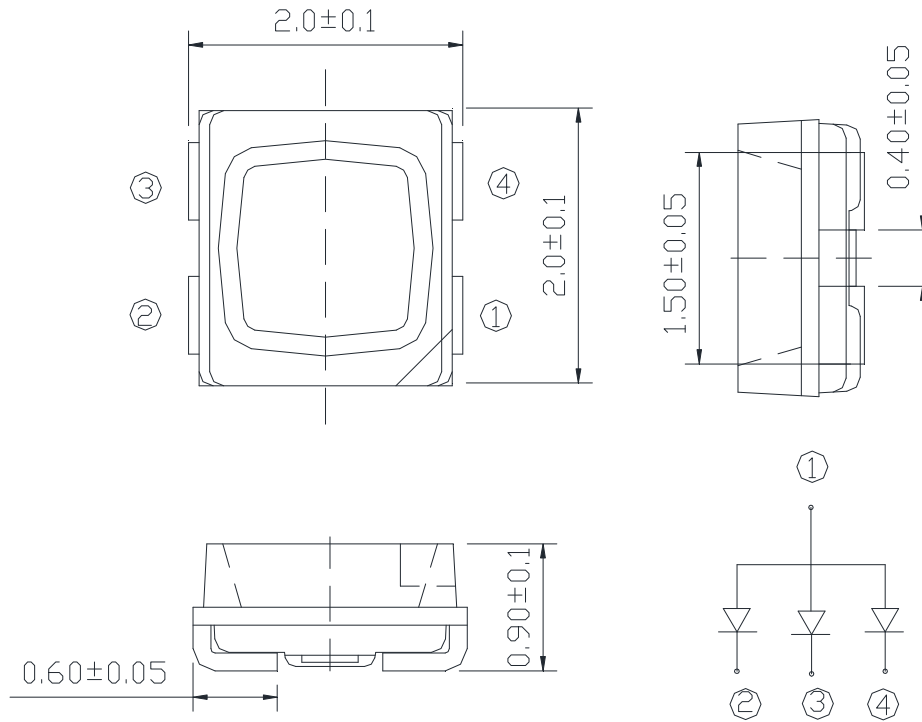

- ① COMMON ANODE
- ② CATHODE FOR BLUE
- ③ CATHODE FOR GREEN
- ④ CATHODE FOR RED

NOTES

RoHS Compliance

The levels of environmentally sensitive, persistent biologically toxic (PBT), persistent organic pollutants (POP), or otherwise restricted materials in this product are below the maximum concentration values (also referred to as the threshold limits) permitted for such substances, or are used in an exempted application, in accordance with EU Directive 2002/95/EC on the restriction of the use of certain hazardous substances in electrical and electronic equipment (RoHS), as amended through April 21, 2006.

Vision Advisory Claim

Users should be cautioned not to stare at the light of this LED product. The bright light can damage the eye.

KIT NUMBER SYSTEM

Cree LED lamps are tested and sorted into performance bins. A bin is specified by ranges of color, forward voltage, and brightness. Sorted LEDs are packaged for shipping in various convenient options. Please refer to the "Cree LED Lamp Packaging Standard" document for more information about shipping and packaging options.

Cree LEDs are sold by order codes in combinations of bins called kits. Order codes are configured in the following manner:

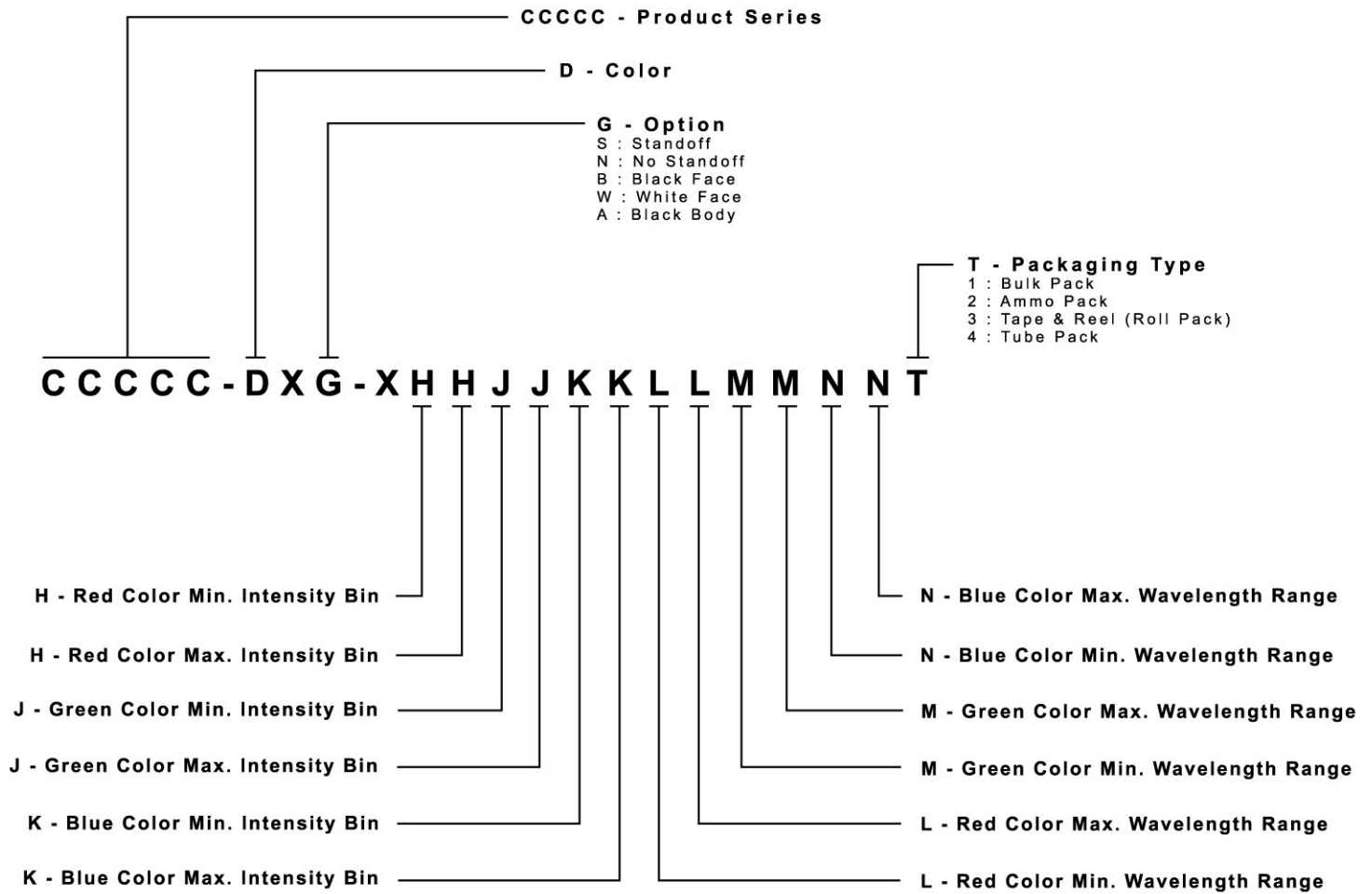

REFLOW SOLDERING

- The CLMVB-FKA is rated as a MSL 5a product.
- The recommended floor life out of bag is 24hrs.
- The best practices suggestion is to bake 24-hour/80°C before use.
- The temperature profile is as below.

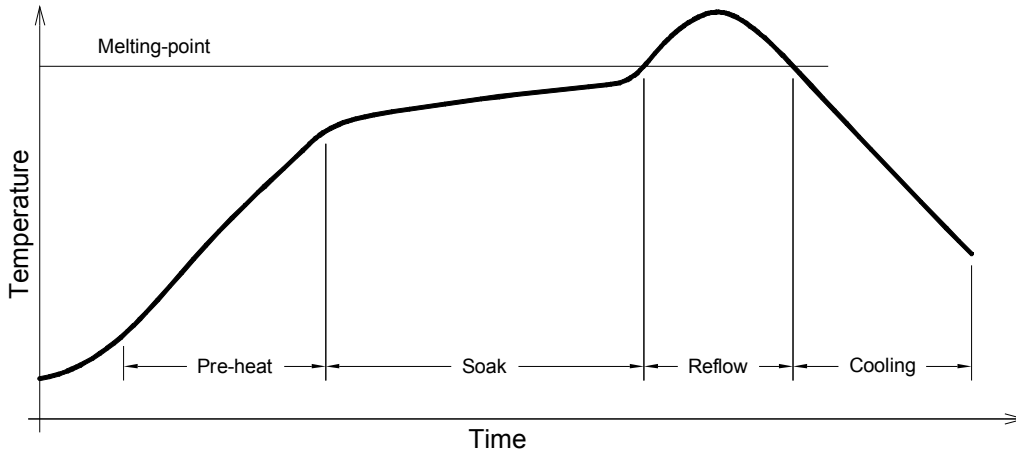

Use only with CLMVB-FKA

Solder = Low Lead-Free
Average ramp-up rate = 4°C/s max
Preheat temperature = 150°C ~200°C
Preheat time = 120s max
Ramp-down rate = 6°C/s max
Peak temperature = 235°C max
Time within 5°C of actual Peak Temperature = 10s max
Duration above 217°C is 45s max

Soldering pad:

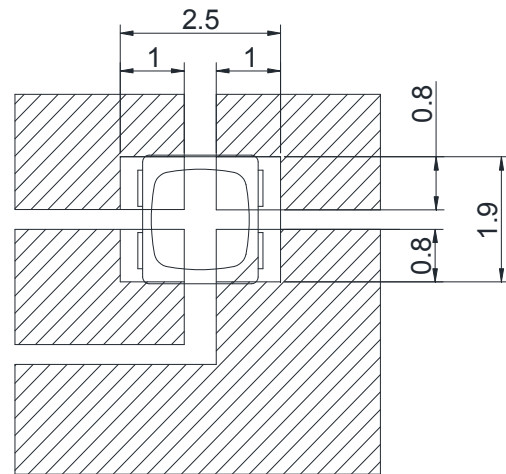

PACKAGING

- The boxes are not water resistant and they must be kept away from water and moisture.
- The LEDs are packed in cardboard boxes after packaging in normal or anti-electrostatic bags.
- Cardboard boxes will be used to protect the LEDs from mechanical shocks during transportation.
- The reel pack is applied in SMD LED.
- Max 3500 pcs per reel.

