

LM34914 Ultra Small 1.25A Step-Down Switching Regulator with Intelligent Current Limit

Check for Samples: [LM34914](#)

FEATURES

- Input Voltage Range: 8V to 40V
- Integrated N-Channel Buck Switch
- Valley Current Limit Varies with V_{IN} and V_{OUT} to Reduce Excessive Inductor Current
- On-time is Reduced when in Current Limit
- Integrated Start-Up Regulator
- No Loop Compensation Required
- Ultra-Fast Transient Response
- Maximum Switching Frequency: 1.3 MHz
- Operating Frequency Remains Nearly Constant with Load Current and Input Voltage Variations
- Programmable Soft-Start
- Precision Internal Reference
- Adjustable Output Voltage
- Thermal Shutdown

TYPICAL APPLICATIONS

- High Efficiency Point-Of-Load (POL) Regulator
- Non-Isolated Buck Regulator
- Secondary High Voltage Post Regulator

DESCRIPTION

The LM34914 Step-Down Switching Regulator features all the functions needed to implement a low cost, efficient, buck bias regulator capable of supplying at least 1.25A to the load. To reduce excessive switch current due to the possibility of a saturating inductor the valley current limit threshold changes with input and output voltages, and the on-time is reduced when current limit is detected. This buck regulator contains a 44V N-Channel Buck Switch, and is available in the thermally enhanced 3 mm x 3 mm WSON-10 package. The feedback regulation scheme requires no loop compensation, results in fast load transient response, and simplifies circuit implementation. The operating frequency remains constant with line and load variations due to the inverse relationship between the input voltage and the on-time. The valley current limit results in a smooth transition from constant voltage to constant current mode when current limit is detected, reducing the frequency and output voltage, without the use of foldback. Additional features include: VCC under-voltage lock-out, thermal shutdown, gate drive under-voltage lock-out, and maximum duty cycle limit.

Package

- WSON-10 (3 mm x 3mm)
- Exposed Thermal Pad For Improved Heat Dissipation

Basic Step Down Regulator

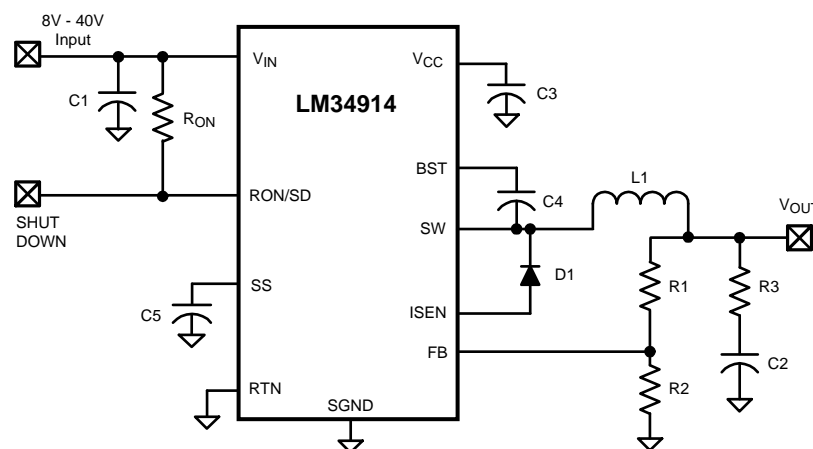

Please be aware that an important notice concerning availability, standard warranty, and use in critical applications of Texas Instruments semiconductor products and disclaimers thereto appears at the end of this data sheet.

All trademarks are the property of their respective owners.

Connection Diagram

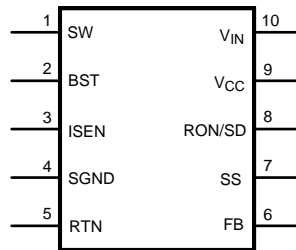

10-Lead WSON

PIN DESCRIPTIONS

Pin Number	Name	Description	Application Information
1	SW	Switching Node	Internally connected to the buck switch source. Connect to the inductor, diode, and bootstrap capacitor.
2	BST	Boost pin for bootstrap capacitor	Connect a 0.022 μ F capacitor from SW to this pin. The capacitor is charged each off-time via an internal diode.
3	ISEN	Current sense	The re-circulating current flows out of this pin to the free-wheeling diode.
4	SGND	Sense Ground	Re-circulating current flows into this pin to the current sense resistor.
5	RTN	Circuit Ground	Ground for all internal circuitry other than the current limit detection.
6	FB	Feedback input from the regulated output	Internally connected to the regulation and over-voltage comparators. The regulation level is 2.5V.
7	SS	Softstart	An internal current source charges an external capacitor to 2.5V, providing the softstart function.
8	RON/SD	On-time control and shutdown	An external resistor from VIN to this pin sets the buck switch on-time. Grounding this pin shuts down the regulator.
9	VCC	Output from the startup regulator	Nominally regulated at 7.0V. Connect a 0.1 μ F capacitor from this pin to RTN. An external voltage (8V to 14V) can be applied to this pin to reduce internal dissipation. An internal diode connects VCC to VIN.
10	VIN	Input supply voltage	Operating input range is 8.0V to 40V.
	EP	Exposed Pad	Exposed metal pad on the underside of the device. It is recommended to connect this pad to the PC board ground plane to aid in heat dissipation.



These devices have limited built-in ESD protection. The leads should be shorted together or the device placed in conductive foam during storage or handling to prevent electrostatic damage to the MOS gates.

Absolute Maximum Ratings⁽¹⁾⁽²⁾

VIN to RTN	44V
BST to RTN	52V
SW to RTN (Steady State)	-1.5V
BST to VCC	44V
VIN to SW	44V
BST to SW	14V
VCC to RTN	14V
SGND to RTN	-0.3V to +0.3V
Current out of ISEN	See text
SS to RTN	-0.3V to 4V
All Other Inputs to RTN	-0.3 to 7V
ESD Rating ⁽³⁾	Human Body Model 2kV
Storage Temperature Range	-65°C to +150°C
Junction Temperature	150°C

- (1) Absolute Maximum Ratings are limits beyond which damage to the device may occur. Operating Ratings are conditions under which operation of the device is intended to be functional. For specifications and test conditions, see [Electrical Characteristics](#).
- (2) If Military/Aerospace specified devices are required, please contact the Texas Instruments Sales Office/Distributors for availability and specifications.
- (3) The human body model is a 100pF capacitor discharged through a 1.5kΩ resistor into each pin.

Operating Ratings⁽¹⁾

VIN Voltage	8.0V to 40V
Junction Temperature	-40°C to +125°C

- (1) Absolute Maximum Ratings are limits beyond which damage to the device may occur. Operating Ratings are conditions under which operation of the device is intended to be functional. For specifications and test conditions, see [Electrical Characteristics](#).

Electrical Characteristics

Limits in standard type are for $T_J = 25^\circ\text{C}$ only; limits in **boldface** type apply over the junction temperature (T_J) range of -40°C to $+125^\circ\text{C}$. Minimum and Maximum limits are specified through test, design, or statistical correlation. Typical values represent the most likely parametric norm at $T_J = 25^\circ\text{C}$, and are provided for reference purposes only. Unless otherwise stated the following conditions apply: $V_{IN} = 12\text{V}$, $R_{ON} = 200\text{k}\Omega$ ⁽¹⁾⁽²⁾.

Symbol	Parameter	Conditions	Min	Typ	Max	Units
Start-Up Regulator, V_{CC}						
V _{CC} Reg	V _{CC} regulated output	V _{in} > 9V	6.6	7.0	7.4	V
	V _{IN} -V _{CC} dropout voltage	I _{CC} = 0 mA, V _{CC} = UVLO _{VCC} + 250 mV		1.3		V
	V _{CC} output impedance (0 mA ≤ I _{CC} ≤ 5 mA)	V _{IN} = 8V		155		Ω
		V _{IN} = 40V		0.16		
	V _{CC} current limit ⁽³⁾	V _{CC} = 0V		11		mA
UVLO _{VCC}	V _{CC} under-voltage lockout threshold	V _{CC} increasing		5.7		V
	UVLO _{VCC} hysteresis	V _{CC} decreasing		150		mV
	UVLO _{VCC} filter delay	100 mV overdrive		3		μs
	I _{IN} operating current	Non-switching, FB = 3V		0.57	0.85	mA
	I _{IN} shutdown current	RON/SD = 0V		80	160	μA

- (1) For detailed information on soldering plastic WSON packages, visit www.ti.com/packaging.
- (2) Typical specifications represent the most likely parametric norm at 25°C operation.
- (3) V_{CC} provides self bias for the internal gate drive and control circuits. Device thermal limitations limit external loading

Electrical Characteristics (continued)

Limits in standard type are for $T_J = 25^\circ\text{C}$ only; limits in **boldface** type apply over the junction temperature (T_J) range of -40°C to $+125^\circ\text{C}$. Minimum and Maximum limits are specified through test, design, or statistical correlation. Typical values represent the most likely parametric norm at $T_J = 25^\circ\text{C}$, and are provided for reference purposes only. Unless otherwise stated the following conditions apply: $V_{IN} = 12\text{V}$, $R_{ON} = 200\text{k}\Omega^{(1)(2)}$.

Symbol	Parameter	Conditions	Min	Typ	Max	Units
Switch Characteristics						
$R_{ds(on)}$	Buck Switch $R_{ds(on)}$	$I_{TEST} = 200\text{ mA}$		0.33	0.7	Ω
$UVLO_{GD}$	Gate Drive UVLO	$V_{BST} - V_{SW}$ Increasing	3.0	4.2	5.5	V
	$UVLO_{GD}$ hysteresis			470		mV
Softstart Pin						
V_{SS}	Pull-up voltage			2.5		V
I_{SS}	Internal current source			12.5		μA
Current Limit						
I_{LIM}	Threshold	$V_{IN} = 8\text{V}$, $V_{FB} = 2.4\text{V}$	1.0	1.2	1.4	A
		$V_{IN} = 30\text{V}$, $V_{FB} = 2.4\text{V}$	0.9	1.1	1.3	
		$V_{IN} = 30\text{V}$, $V_{FB} = 1.0\text{V}$	0.85	1.05	1.25	
	Response time			150		ns
On Timer						
t_{ON-1}	On-time (normal operation)	$V_{IN} = 10\text{V}$, $R_{ON} = 200\text{ k}\Omega$	2.1	2.8	3.4	μs
t_{ON-2}	On-time (normal operation)	$V_{IN} = 40\text{V}$, $R_{ON} = 200\text{ k}\Omega$		655		ns
t_{ON-3}	On-time (current limit)	$V_{IN} = 10\text{V}$, $R_{ON} = 200\text{ k}\Omega$		1.13		μs
	Shutdown threshold at R_{ON}/SD	Voltage at R_{ON}/SD rising	0.4	0.8	1.2	V
	Shutdown Threshold hysteresis	Voltage at R_{ON}/SD falling		32		mV
Off Timer						
t_{OFF}	Minimum Off-time			265		ns
Regulation and Over-Voltage Comparators (FB Pin)						
V_{REF}	FB regulation threshold	SS pin = steady state	2.445	2.50	2.550	V
	FB over-voltage threshold			2.9		V
	FB bias current			15		nA
Thermal Shutdown						
T_{SD}	Thermal shutdown temperature	Junction temperature rising		175		$^\circ\text{C}$
	Thermal shutdown hysteresis			20		$^\circ\text{C}$
Thermal Resistance						
θ_{JA}	Junction to Ambient 0 LFPM Air Flow ⁽⁴⁾			30		$^\circ\text{C}/\text{W}$
θ_{JC}	Junction to Case ⁽⁴⁾			8		$^\circ\text{C}/\text{W}$

(4) Value shown assumes a 4-layer PC board and 4 vias to conduct heat from beneath the package.

Typical Performance Characteristics

Unless otherwise specified the following conditions apply: $T_J = 25^\circ\text{C}$

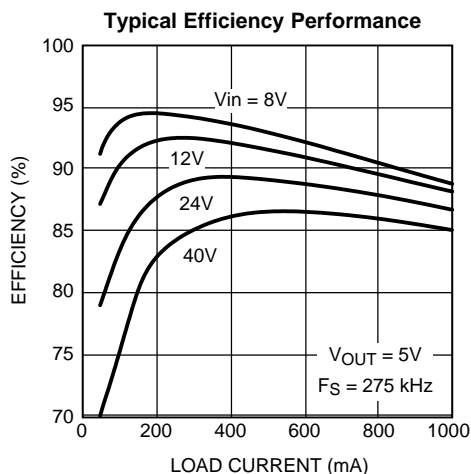

Figure 1.

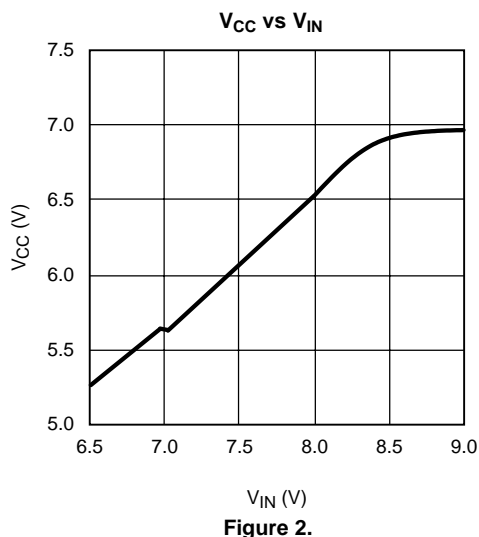

Figure 2.

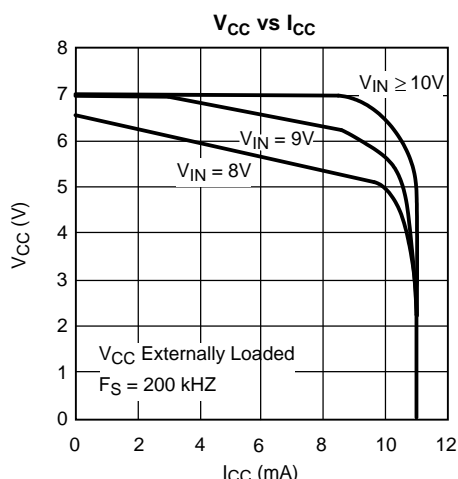

Figure 3.

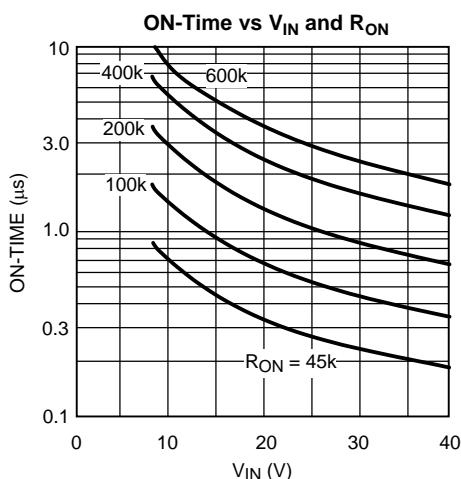

Figure 4.

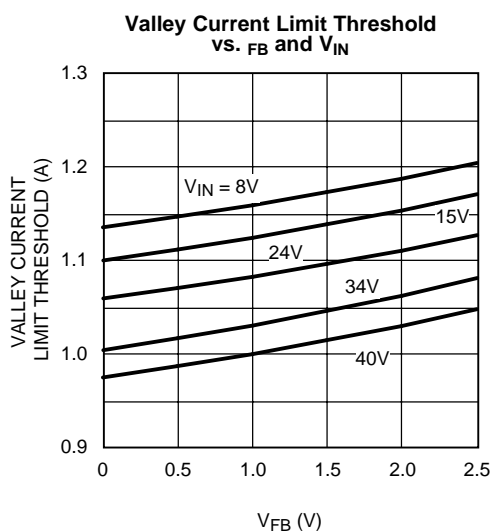

Figure 5.

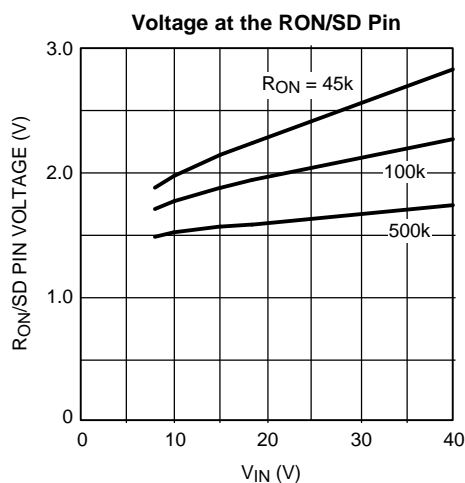
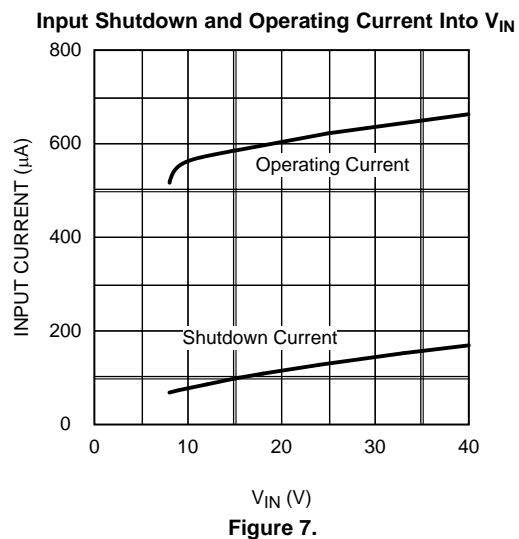
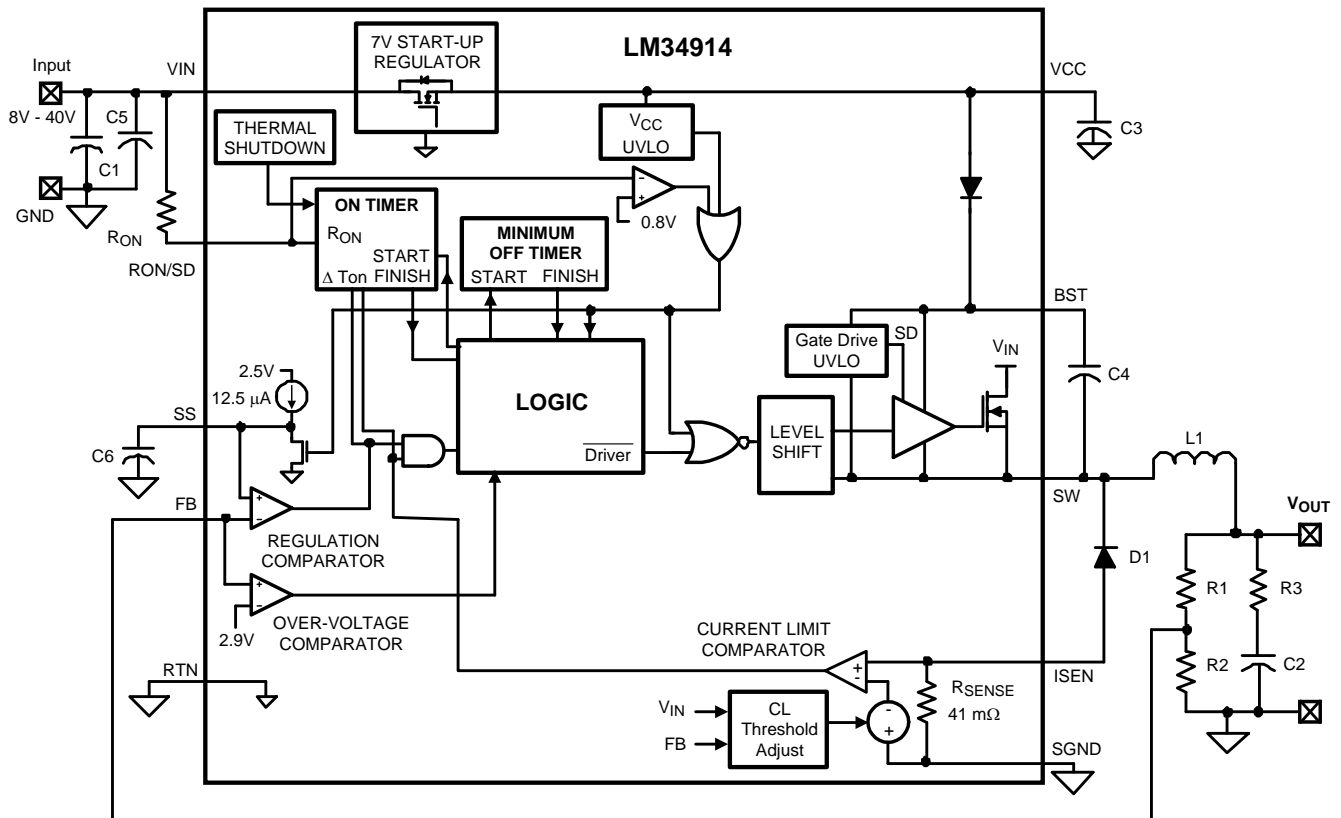

Figure 6.

Typical Performance Characteristics (continued)Unless otherwise specified the following conditions apply: $T_J = 25^\circ\text{C}$ 

Typical Application Circuit and Block Diagram



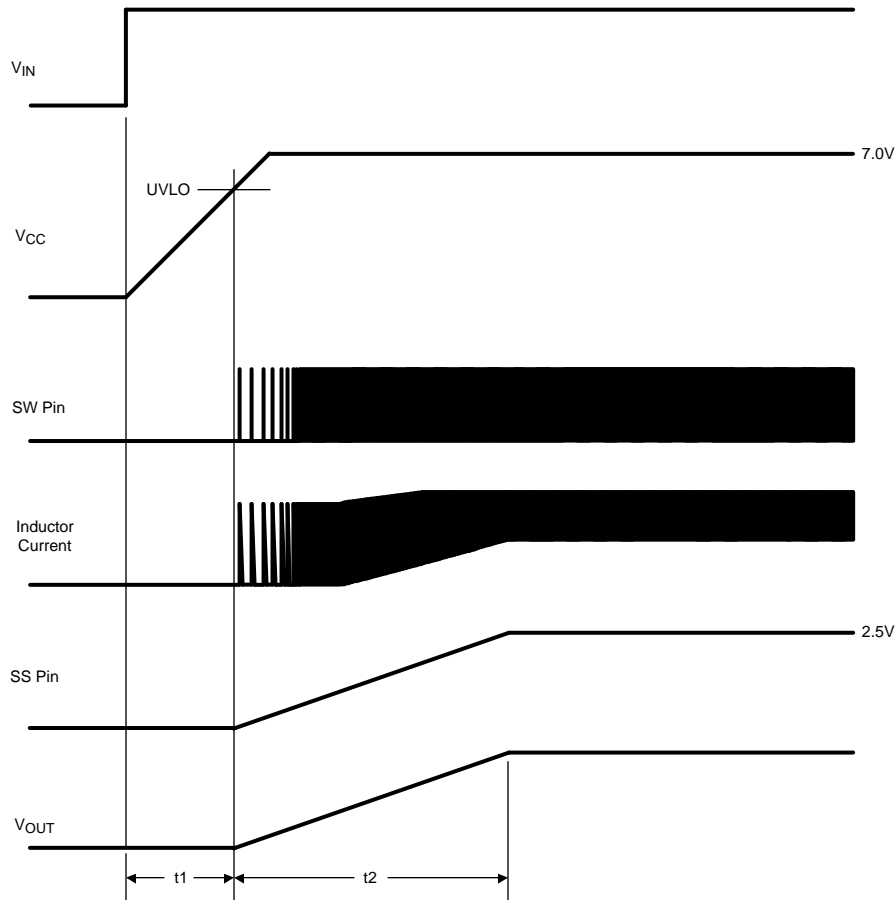

Figure 8. Startup Sequence

Functional Description

The LM34914 Step Down Switching Regulator features all the functions needed to implement a low cost, efficient buck bias power converter capable of supplying at least 1.25A to the load. This high voltage regulator contains an N-Channel buck switch, is easy to implement, and is available in the thermally enhanced 3mm x 3mm WSON-10 package. The regulator's operation is based on a constant on-time control scheme where the on-time is determined by V_{IN} . This feature results in the operating frequency remaining relatively constant with load and input voltage variations. The feedback control scheme requires no loop compensation resulting in very fast load transient response. The valley current limit scheme protects against excessively high currents if the output is short circuited when V_{IN} is high. To aid in controlling excessive switch current due to a possible saturating inductor the valley current limit threshold changes with input and output voltages, and the on-time is reduced by approximately 50% when current limit is detected. The LM34914 can be applied in numerous applications to efficiently regulate down higher voltages. Additional features include: Thermal shutdown, V_{CC} under-voltage lock-out, gate drive under-voltage lock-out, and maximum duty cycle limit.

Control Circuit Overview

The LM34914 buck DC-DC regulator employs a control scheme based on a comparator and a one-shot on-timer, with the output voltage feedback (FB) compared to an internal reference (2.5V). If the FB voltage is below the reference the buck switch is switched on for a time period determined by the input voltage and a programming resistor (R_{ON}). Following the on-time the switch remains off until the FB voltage falls below the reference, but not less than the minimum off-time forced by the LM34914. The buck switch is then turned on for another on-time period.

When in regulation, the LM34914 operates in continuous conduction mode at heavy load currents and discontinuous conduction mode at light load currents. In continuous conduction mode the inductor's current is always greater than zero, and the operating frequency remains relatively constant with load and line variations. The minimum load current for continuous conduction mode is one-half the inductor's ripple current amplitude. The approximate operating frequency is calculated as follows:

$$F_S = \frac{V_{OUT} \times (V_{IN} - 1.5)}{1.15 \times 10^{-10} \times (R_{ON} + 1.4k) \times V_{IN}} \quad (1)$$

The buck switch duty cycle is equal to:

$$DC = \frac{t_{ON}}{t_{ON} + t_{OFF}} = t_{ON} \times F_S = \frac{V_{OUT}}{V_{IN}} \quad (2)$$

In discontinuous conduction mode, where the inductor's current reaches zero during the off-time forcing a longer-than-normal off-time, the operating frequency is lower than in continuous conduction mode, and varies with load current. Conversion efficiency is maintained at light loads since the switching losses decrease with the reduction in load and frequency. The approximate discontinuous operating frequency can be calculated as follows:

$$F_S = \frac{V_{OUT}^2 \times L1 \times 1.5 \times 10^{20}}{R_L \times R_{ON}^2} \quad (3)$$

where R_L = the load resistance, and L1 is the circuit's inductor.

The output voltage is set by the two feedback resistors (R1, R2 in the [Block Diagram](#)). The regulated output voltage is calculated as follows:

$$V_{OUT} = 2.5 \times (R1 + R2) / R2 \quad (4)$$

Output voltage regulation is based on supplying ripple voltage to the feedback input (FB pin), normally obtained from the output voltage ripple through the feedback resistors. The LM34914 requires a minimum of 25 mVp-p of ripple voltage at the FB pin, requiring the ripple voltage at V_{OUT} be higher by the gain factor of the feedback resistor ratio. The output ripple voltage is created by the inductor's ripple current passing through R3 which is in series with the output capacitor. For applications where reduced ripple is required at V_{OUT} , see [Applications Information](#).

If the voltage at FB rises above 2.9V, due to a transient at V_{OUT} or excessive inductor current which creates higher than normal ripple at V_{OUT} , the internal over-voltage comparator immediately shuts off the internal buck switch. The next on-time starts when the voltage FB falls below 2.5V and the inductor current falls below the current limit threshold.

ON-Time Timer

The on-time for the LM34914 is determined by the R_{ON} resistor and the input voltage (V_{IN}), calculated from:

$$t_{ON} = \frac{1.15 \times 10^{-10} \times (R_{ON} + 1.4k)}{(V_{IN} - 1.5)} + 50 \text{ ns} \quad (5)$$

The inverse relationship with V_{IN} results in a nearly constant frequency as V_{IN} is varied. To set a specific continuous conduction mode switching frequency (F_S), the R_{ON} resistor is determined from the following:

$$R_{ON} = \frac{V_{OUT} \times (V_{IN} - 1.5)}{F_S \times 1.15 \times 10^{-10} \times V_{IN}} - 1.4k \quad (6)$$

[Equation 1](#), [Equation 5](#), and [Equation 6](#) are valid only during normal operation - i.e., the circuit is not in current limit. When the LM34914 operates in current limit, the on-time is reduced by approximately 50%. This feature reduces the peak inductor current which may be excessively high if the load current and the input voltage are simultaneously high. This feature operates on a cycle-by-cycle basis until the load current is reduced and the output voltage resumes its normal regulated value.

Shutdown

The LM34914 can be remotely shut down by taking the RON/SD pin below 0.8V. See [Figure 9](#). In this mode the SS pin is internally grounded, the on-timer is disabled, and bias currents are reduced. Releasing the RON/SD pin allows the circuit to resume operation. The voltage at the RON/SD pin is normally between 1.5V and 3.0V, depending on V_{IN} and the R_{ON} resistor.

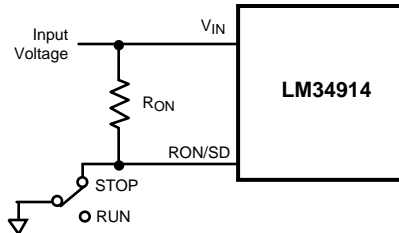

Figure 9. Shutdown Implementation

Current Limit

Current limit detection occurs during the off-time by monitoring the recirculating current flowing out of the ISEN pin. Referring to the [Typical Application Circuit and Block Diagram](#), during the off-time the inductor current flows through the load, into SGND, through the internal sense resistor, out of ISEN and through D1 to the inductor. If that current exceeds the current limit threshold the current limit comparator output delays the start of the next on-time period. The next on-time starts when the current out of ISEN is below the threshold **and** the voltage at FB falls below 2.5V. The operating frequency is typically lower due to longer-than-normal off-times.

The valley current limit threshold is a function of the input voltage (V_{IN}) and the output voltage sensed at FB, as shown in the graph “Valley Current Limit Threshold vs. V_{FB} and V_{IN} ”. This feature reduces the inductor current’s peak value at high line and load. To further reduce the inductor’s peak current, the next cycle’s on-time is reduced by approximately 50% if the voltage at FB is below its threshold when the inductor current reduces to the current limit threshold (V_{OUT} is low due to current limiting).

[Figure 10](#) illustrates the inductor current waveform during normal operation and in current limit. During the first “Normal Operation” the load current is I_{OUT1} , the average of the ripple waveform. As the load resistance is reduced, the inductor current increases until it exceeds the current limit threshold. During the “Current Limited” portion of [Figure 10](#), the current limit threshold lowers since the high load current causes V_{OUT} (and the voltage at FB) to reduce. The on-time is reduced by approximately 50%, resulting in lower ripple amplitude for the inductor’s current. During this time the LM34914 is in a constant current mode, with an average load current equal to the current limit threshold + $\Delta I/2$ (I_{OUT2}). Normal operation resumes when the load current is reduced to I_{OUT3} , allowing V_{OUT} , the current limit threshold, and the on-time to return to their normal values. Note that in the second period of “Normal Operation”, even though the inductor’s peak current exceeds the current limit threshold during part of each cycle, the circuit is not in current limit since the current falls below the threshold before the feedback voltage reduces to its threshold.

The peak current allowed through the buck switch, and the ISEN pin, is 2A, and the maximum allowed average current is 1.5A.

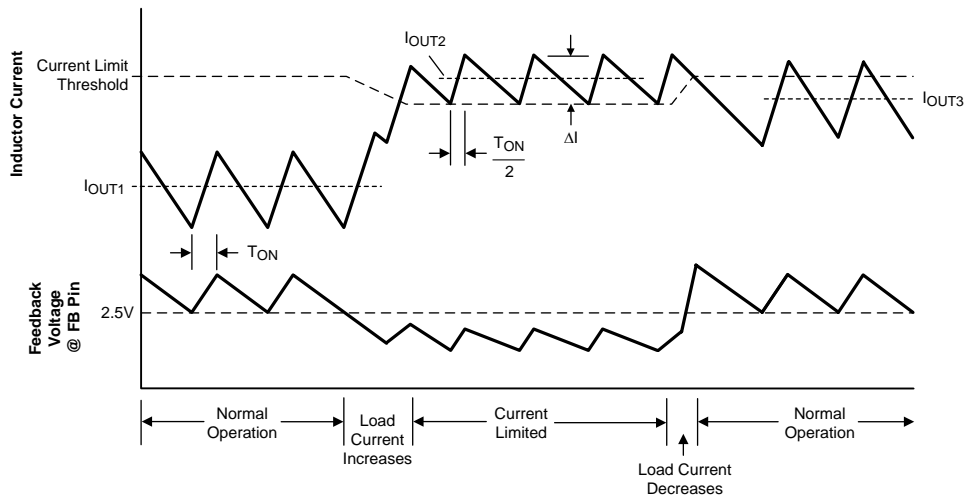

Figure 10. Inductor Current - Normal and Current Limit Operation

N - Channel Buck Switch and Driver

The LM34914 integrates an N-Channel buck switch and associated floating high voltage gate driver. The gate driver circuit works in conjunction with an external bootstrap capacitor and an internal high voltage diode. A 0.022 μF capacitor (C4) connected between BST and SW provides the voltage to the driver during the on-time. During each off-time, the SW pin is at approximately -1V, and C4 is recharged for the next on-time from V_{CC} through the internal diode. The minimum off-time ensures a minimum time each cycle to recharge the bootstrap capacitor.

Softstart

The softstart feature allows the converter to gradually reach a steady state operating point, thereby reducing start-up stresses and current surges. Upon turn-on, after V_{CC} reaches the under-voltage threshold, an internal 12.5 μA current source charges up the external capacitor at the SS pin to 2.5V (t_2 in Figure 8). The ramping voltage at SS (and the non-inverting input of the regulation comparator) ramps up the output voltage in a controlled manner.

An internal switch grounds the SS pin if V_{CC} is below the under-voltage lockout threshold, or if the RON/SD pin is grounded.

Thermal Shutdown

The LM34914 should be operated so the junction temperature does not exceed 125°C. If the junction temperature increases above that, an internal Thermal Shutdown circuit activates (typically) at 175°C, taking the controller to a low power reset state by disabling the buck switch and the on-timer. This feature helps prevent catastrophic failures from accidental device overheating. When the junction temperature reduces below 155°C (typical hysteresis = 20°C), normal operation resumes.

APPLICATIONS INFORMATION

EXTERNAL COMPONENTS

The following guidelines can be used to select the external components (see the [Block Diagram](#)). First determine the following operating parameters:

- Output voltage (V_{OUT})
- Minimum and maximum input voltage ($V_{IN(min)}$ and $V_{IN(max)}$)
- Minimum and maximum load current ($I_{OUT(min)}$ and $I_{OUT(max)}$)
- Switching Frequency (F_S)

R1 and R2: These resistors set the output voltage. The ratio of these resistors is calculated from:

$$R1/R2 = (V_{OUT}/2.5V) - 1 \quad (7)$$

R1 and R2 should be chosen from standard value resistors in the range of 1.0 k Ω - 10 k Ω which satisfy the above ratio.

R_{ON}: The resistor sets the on-time, and consequently, the switching frequency. Its value can be determined using [Equation 6](#) based on the frequency, or [Equation 5](#) if a specific on-time is required. The minimum allowed value for R_{ON} is calculated from:

$$R_{ON} \geq \frac{100 \text{ ns} \times (V_{IN(MAX)} - 1.5V)}{1.15 \times 10^{-10}} - 1.4 \text{ k}\Omega \quad (8)$$

L1: The main parameter affected by the inductor is the output current ripple amplitude (I_{OR}). The minimum load current is used to determine the maximum allowable ripple. In order to maintain continuous conduction mode the valley should not reach 0 mA. This is not a requirement of the LM34914, but serves as a guideline for selecting L1. For this case, the maximum ripple current is:

$$I_{OR(MAX)} = 2 \times I_{OUT(min)} \quad (9)$$

If the minimum load current is zero, use 20% of $I_{OUT(max)}$ for $I_{OUT(min)}$ in [Equation 9](#). The ripple calculated in [Equation 6](#) is then used in the following equation:

$$L1 = \frac{V_{OUT} \times (V_{IN(max)} - V_{OUT})}{I_{OR(max)} \times F_S \times V_{IN(max)}} \quad (10)$$

where F_S is the switching frequency. This provides a minimum value for L1. The next larger standard value should be used, and L1 should be rated for the peak current level, equal to $I_{OUT(max)} + I_{OR(max)}/2$.

C2 and R3: Since the LM34914 requires a minimum of 25 mVp-p of ripple at the FB pin for proper operation, the required ripple at V_{OUT} is increased by R1 and R2. This necessary ripple is created by the inductor ripple current flowing through R3, and to a lesser extent by C2 and its ESR. The minimum inductor ripple current is calculated using [Equation 10](#), rearranged to solve for I_{OR} at minimum V_{IN} .

$$I_{OR(min)} = \frac{V_{OUT} \times (V_{IN(min)} - V_{OUT})}{L1 \times F_S \times V_{IN(min)}} \quad (11)$$

The minimum value for R3 is then equal to:

$$R3_{(min)} = \frac{25 \text{ mV} \times (R1 + R2)}{R2 \times I_{OR(min)}} \quad (12)$$

Typically R3 is less than 5 Ω . C2 should generally be no smaller than 3.3 μ F, although that is dependent on the frequency and the desired output characteristics. C2 should be a low ESR good quality ceramic capacitor. Experimentation is usually necessary to determine the minimum value for C2, as the nature of the load may require a larger value. A load which creates significant transients requires a larger value for C2 than a non-varying load.

D1: A Schottky diode is recommended. Ultra-fast recovery diodes are not recommended as the high speed transitions at the SW pin may inadvertently affect the IC's operation through external or internal EMI. The diode should be rated for the maximum input voltage ($V_{IN(max)}$), the maximum load current ($I_{OUT(max)}$), and the peak current which occurs when the current limit and maximum ripple current are reached simultaneously. The diode's average power dissipation is calculated from:

$$P_{D1} = V_F \times I_{OUT} \times (1-D) \quad (13)$$

where V_F is the diode's forward voltage drop, and D is the duty cycle.

C1 and C5: C1's purpose is to supply most of the switch current during the on-time, and limit the voltage ripple at V_{IN} , on the assumption that the voltage source feeding V_{IN} has an output impedance greater than zero. If the source's dynamic impedance is high (effectively a current source), it supplies the average input current, but not the ripple current.

At maximum load current, when the buck switch turns on, the current into V_{IN} suddenly increases to the lower peak of the inductor's ripple current, ramps up to the upper peak, then drop to zero at turn-off. The average current during the on-time is the load current. For a worst case calculation, C1 must supply this average load current during the maximum on-time. C1 is calculated from:

$$C1 = \frac{I_{OUT(max)} \times t_{ON}}{\Delta V} \quad (14)$$

where t_{ON} is the maximum on-time, and ΔV is the allowable ripple voltage at V_{IN} . C5's purpose is to help avoid transients and ringing due to long lead inductance leading to the V_{IN} pin. A low ESR, 0.1 μF ceramic chip capacitor is recommended, and **must** be located close to the V_{IN} and RTN pins.

C3: The capacitor at the V_{CC} output provides not only noise filtering and stability, but also prevents false triggering of the V_{CC} UVLO at the buck switch on/off transitions. C3 should be no smaller than 0.1 μF , and should be a good quality, low ESR, ceramic capacitor. C3's value, and the V_{CC} current limit, determine a portion of the turn-on-time ($t1$ in [Figure 8](#)).

C4: The recommended value for C4 is 0.022 μF . A high quality ceramic capacitor with low ESR is recommended as C4 supplies a surge current to charge the buck switch gate at turn-on. A low ESR also helps ensure a complete recharge during each off-time.

C6: The capacitor at the SS pin determines the softstart time, i.e. the time for the output voltage, to reach its final value ($t2$ in [Figure 8](#)). The capacitor value is determined from the following:

$$C6 = \frac{t_2 \times 12.5 \mu A}{2.5V} \quad (15)$$

PC BOARD LAYOUT

The LM34914 regulation, over-voltage, and current limit comparators are very fast, and respond to short duration noise pulses. Layout considerations are therefore critical for optimum performance. The layout must be as neat and compact as possible, and all of the components must be as close as possible to their associated pins. The current loop formed by D1, L1, C2 and the SGND and ISEN pins should be as small as possible. The ground connection from SGND and RTN to C1 should be as short and direct as possible.

If it is expected that the internal dissipation of the LM34914 will produce excessive junction temperatures during normal operation, good use of the PC board's ground plane can help to dissipate heat. The exposed pad on the bottom of the IC package can be soldered to a ground plane, and that plane should extend out from beneath the IC, and be connected to ground plane on the board's other side with several vias, to help dissipate the heat. The exposed pad is internally connected to the IC substrate. Additionally the use of wide PC board traces, where possible, can help conduct heat away from the IC. Judicious positioning of the PC board within the end product, along with the use of any available air flow (forced or natural convection) can help reduce the junction temperatures.

LOW OUTPUT RIPPLE CONFIGURATIONS

For applications where low output ripple is required, the following options can be used to reduce or nearly eliminate the ripple.

a) Reduced ripple configuration: In Figure 11, Cff is added across R1 to AC-couple the ripple at V_{OUT} directly to the FB pin. This allows the ripple at V_{OUT} to be reduced to a minimum of 25 mVp-p by reducing R3, since the ripple at V_{OUT} is not attenuated by the feedback resistors. The minimum value for Cff is determined from:

$$C_{ff} = \frac{t_{ON(max)}}{(R1/R2)} \quad (16)$$

where t_{ON(max)} is the maximum on-time, which occurs at V_{IN(min)}. The next larger standard value capacitor should be used for Cff. R1 and R2 should each be towards the upper end of the 1kΩ to 10kΩ range.

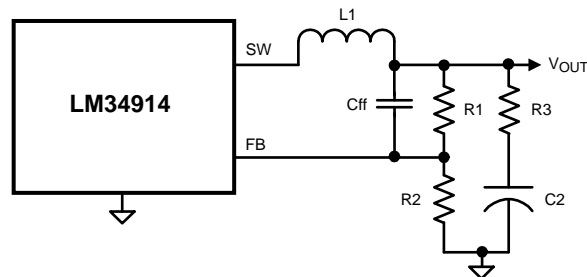

Figure 11. Reduced Ripple Configuration

b) Minimum ripple configuration: If the application requires a lower value of ripple (<10 mVp-p), the circuit of Figure 12 can be used. R3 is removed, and the resulting output ripple voltage is determined by the inductor's ripple current and C2's characteristics. RA and CA are chosen to generate a sawtooth waveform at their junction, and that voltage is AC-coupled to the FB pin via CB. To determine the values for RA, CA and CB, use the following procedure:

$$\text{Calculate } V_A = V_{OUT} - (V_{SW} \times (1 - (V_{OUT}/V_{IN(min)}))) \quad (17)$$

where V_{SW} is the absolute value of the voltage at the SW pin during the off-time (typically 1V). V_A is the DC voltage at the RA/CA junction, and is used in the next equation.

$$\text{Calculate } RA \times CA = (V_{IN(min)} - V_A) \times t_{ON}/\Delta V \quad (18)$$

where t_{ON} is the maximum on-time (at minimum input voltage), and ΔV is the desired ripple amplitude at the RA/CA junction (typically 40-50 mV). RA and CA are then chosen from standard value components to satisfy the above product. Typically CA is 1000 pF to 5000 pF, and RA is 100kΩ to 300 kΩ. CB is then chosen large compared to CA, typically 0.1 μF. R1 and R2 should each be towards the upper end of the 1kΩ to 10kΩ range.

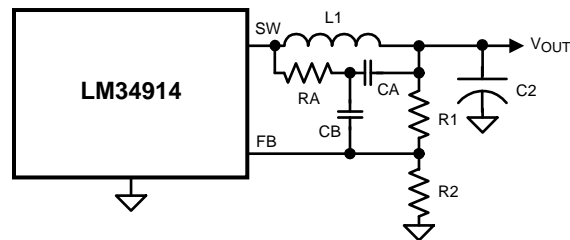

Figure 12. Minimum Output Ripple Using Ripple Injection

c) Alternate minimum ripple configuration: The circuit in [Figure 13](#) is the same as that in the [Block Diagram](#), except the output voltage is taken from the junction of R3 and C2. The ripple at V_{OUT} is determined by the inductor's ripple current and C2's characteristics. However, R3 slightly degrades the load regulation. This circuit may be suitable if the load current is fairly constant.

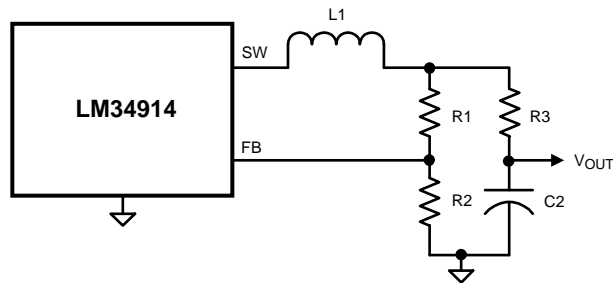

Figure 13. Alternate Minimum Output Ripple

REVISION HISTORY

Changes from Revision A (March 2013) to Revision B	Page
• Changed layout of National Data Sheet to TI format	15

PACKAGING INFORMATION

Orderable Device	Status (1)	Package Type	Package Drawing	Pins	Package Qty	Eco Plan (2)	Lead/Ball Finish	MSL Peak Temp (3)	Op Temp (°C)	Device Marking (4/5)	Samples
LM34914SD/NOPB	ACTIVE	WSON	DSC	10	1000	Green (RoHS & no Sb/Br)	CU SN	Level-1-260C-UNLIM	-40 to 125	34914	Samples
LM34914SDX/NOPB	ACTIVE	WSON	DSC	10	4500	Green (RoHS & no Sb/Br)	CU SN	Level-1-260C-UNLIM	-40 to 125	34914	Samples

(1) The marketing status values are defined as follows:

ACTIVE: Product device recommended for new designs.

LIFEBUY: TI has announced that the device will be discontinued, and a lifetime-buy period is in effect.

NRND: Not recommended for new designs. Device is in production to support existing customers, but TI does not recommend using this part in a new design.

PREVIEW: Device has been announced but is not in production. Samples may or may not be available.

OBSOLETE: TI has discontinued the production of the device.

(2) Eco Plan - The planned eco-friendly classification: Pb-Free (RoHS), Pb-Free (RoHS Exempt), or Green (RoHS & no Sb/Br) - please check <http://www.ti.com/productcontent> for the latest availability information and additional product content details.

TBD: The Pb-Free/Green conversion plan has not been defined.

Pb-Free (RoHS): TI's terms "Lead-Free" or "Pb-Free" mean semiconductor products that are compatible with the current RoHS requirements for all 6 substances, including the requirement that lead not exceed 0.1% by weight in homogeneous materials. Where designed to be soldered at high temperatures, TI Pb-Free products are suitable for use in specified lead-free processes.

Pb-Free (RoHS Exempt): This component has a RoHS exemption for either 1) lead-based flip-chip solder bumps used between the die and package, or 2) lead-based die adhesive used between the die and leadframe. The component is otherwise considered Pb-Free (RoHS compatible) as defined above.

Green (RoHS & no Sb/Br): TI defines "Green" to mean Pb-Free (RoHS compatible), and free of Bromine (Br) and Antimony (Sb) based flame retardants (Br or Sb do not exceed 0.1% by weight in homogeneous material)

(3) MSL, Peak Temp. -- The Moisture Sensitivity Level rating according to the JEDEC industry standard classifications, and peak solder temperature.

(4) There may be additional marking, which relates to the logo, the lot trace code information, or the environmental category on the device.

(5) Multiple Device Markings will be inside parentheses. Only one Device Marking contained in parentheses and separated by a "~" will appear on a device. If a line is indented then it is a continuation of the previous line and the two combined represent the entire Device Marking for that device.

Important Information and Disclaimer: The information provided on this page represents TI's knowledge and belief as of the date that it is provided. TI bases its knowledge and belief on information provided by third parties, and makes no representation or warranty as to the accuracy of such information. Efforts are underway to better integrate information from third parties. TI has taken and continues to take reasonable steps to provide representative and accurate information but may not have conducted destructive testing or chemical analysis on incoming materials and chemicals. TI and TI suppliers consider certain information to be proprietary, and thus CAS numbers and other limited information may not be available for release.

In no event shall TI's liability arising out of such information exceed the total purchase price of the TI part(s) at issue in this document sold by TI to Customer on an annual basis.

TAPE AND REEL INFORMATION

QUADRANT ASSIGNMENTS FOR PIN 1 ORIENTATION IN TAPE

*All dimensions are nominal

Device	Package Type	Package Drawing	Pins	SPQ	Reel Diameter (mm)	Reel Width W1 (mm)	A0 (mm)	B0 (mm)	K0 (mm)	P1 (mm)	W (mm)	Pin1 Quadrant
LM34914SD/NOPB	WSON	DSC	10	1000	178.0	12.4	3.3	3.3	1.0	8.0	12.0	Q1
LM34914SDX/NOPB	WSON	DSC	10	4500	330.0	12.4	3.3	3.3	1.0	8.0	12.0	Q1

TAPE AND REEL BOX DIMENSIONS

*All dimensions are nominal

Device	Package Type	Package Drawing	Pins	SPQ	Length (mm)	Width (mm)	Height (mm)
LM34914SD/NOPB	WSON	DSC	10	1000	210.0	185.0	35.0
LM34914SDX/NOPB	WSON	DSC	10	4500	367.0	367.0	35.0

IMPORTANT NOTICE

Texas Instruments Incorporated and its subsidiaries (TI) reserve the right to make corrections, enhancements, improvements and other changes to its semiconductor products and services per JESD46, latest issue, and to discontinue any product or service per JESD48, latest issue. Buyers should obtain the latest relevant information before placing orders and should verify that such information is current and complete. All semiconductor products (also referred to herein as "components") are sold subject to TI's terms and conditions of sale supplied at the time of order acknowledgment.

TI warrants performance of its components to the specifications applicable at the time of sale, in accordance with the warranty in TI's terms and conditions of sale of semiconductor products. Testing and other quality control techniques are used to the extent TI deems necessary to support this warranty. Except where mandated by applicable law, testing of all parameters of each component is not necessarily performed.

TI assumes no liability for applications assistance or the design of Buyers' products. Buyers are responsible for their products and applications using TI components. To minimize the risks associated with Buyers' products and applications, Buyers should provide adequate design and operating safeguards.

TI does not warrant or represent that any license, either express or implied, is granted under any patent right, copyright, mask work right, or other intellectual property right relating to any combination, machine, or process in which TI components or services are used. Information published by TI regarding third-party products or services does not constitute a license to use such products or services or a warranty or endorsement thereof. Use of such information may require a license from a third party under the patents or other intellectual property of the third party, or a license from TI under the patents or other intellectual property of TI.

Reproduction of significant portions of TI information in TI data books or data sheets is permissible only if reproduction is without alteration and is accompanied by all associated warranties, conditions, limitations, and notices. TI is not responsible or liable for such altered documentation. Information of third parties may be subject to additional restrictions.

Resale of TI components or services with statements different from or beyond the parameters stated by TI for that component or service voids all express and any implied warranties for the associated TI component or service and is an unfair and deceptive business practice. TI is not responsible or liable for any such statements.

Buyer acknowledges and agrees that it is solely responsible for compliance with all legal, regulatory and safety-related requirements concerning its products, and any use of TI components in its applications, notwithstanding any applications-related information or support that may be provided by TI. Buyer represents and agrees that it has all the necessary expertise to create and implement safeguards which anticipate dangerous consequences of failures, monitor failures and their consequences, lessen the likelihood of failures that might cause harm and take appropriate remedial actions. Buyer will fully indemnify TI and its representatives against any damages arising out of the use of any TI components in safety-critical applications.

In some cases, TI components may be promoted specifically to facilitate safety-related applications. With such components, TI's goal is to help enable customers to design and create their own end-product solutions that meet applicable functional safety standards and requirements. Nonetheless, such components are subject to these terms.

No TI components are authorized for use in FDA Class III (or similar life-critical medical equipment) unless authorized officers of the parties have executed a special agreement specifically governing such use.

Only those TI components which TI has specifically designated as military grade or "enhanced plastic" are designed and intended for use in military/aerospace applications or environments. Buyer acknowledges and agrees that any military or aerospace use of TI components which have **not** been so designated is solely at the Buyer's risk, and that Buyer is solely responsible for compliance with all legal and regulatory requirements in connection with such use.

TI has specifically designated certain components as meeting ISO/TS16949 requirements, mainly for automotive use. In any case of use of non-designated products, TI will not be responsible for any failure to meet ISO/TS16949.

Products

Audio	www.ti.com/audio
Amplifiers	amplifier.ti.com
Data Converters	dataconverter.ti.com
DLP® Products	www.dlp.com
DSP	dsp.ti.com
Clocks and Timers	www.ti.com/clocks
Interface	interface.ti.com
Logic	logic.ti.com
Power Mgmt	power.ti.com
Microcontrollers	microcontroller.ti.com
RFID	www.ti-rfid.com
OMAP Applications Processors	www.ti.com/omap
Wireless Connectivity	www.ti.com/wirelessconnectivity

Applications

Automotive and Transportation	www.ti.com/automotive
Communications and Telecom	www.ti.com/communications
Computers and Peripherals	www.ti.com/computers
Consumer Electronics	www.ti.com/consumer-apps
Energy and Lighting	www.ti.com/energy
Industrial	www.ti.com/industrial
Medical	www.ti.com/medical
Security	www.ti.com/security
Space, Avionics and Defense	www.ti.com/space-avionics-defense
Video and Imaging	www.ti.com/video

TI E2E Community

e2e.ti.com