

Overview

The KEMET SS Coils, SS17HB Type AC line filters are offered in a wide variety of sizes and specifications.

Applications

- Consumer Electronics
- Common mode choke

Benefits

- Wide variety of sizes and specifications
- Inductances up to 30 mH
- Rated Currents up to 1.7 A
- DC Resistances as low as 0.10 Ω



Part Number System

SS	17	HB-	R	13	020
Series	Core Size (mm)	Core Orientation	Core Type	Rated Current (A)	Minimum Inductance (mH)
SS	17 = 17.0	HB- = Horizontal	Blank = Standard R = High permeability	0x = 0.x A (e.g., 04 = 0.4 A) xx = x.x A (e.g., 13 = 1.3 A)	00x = 0.x mH (e.g., 008 = 0.8 mH) 0xx = x.x mH (e.g., 020 = 2.0 mH) xxx = xx.x mH (e.g., 125 = 12.5 mH) Note: Code 018 = 1.5 mH

Dimensions – Millimeters

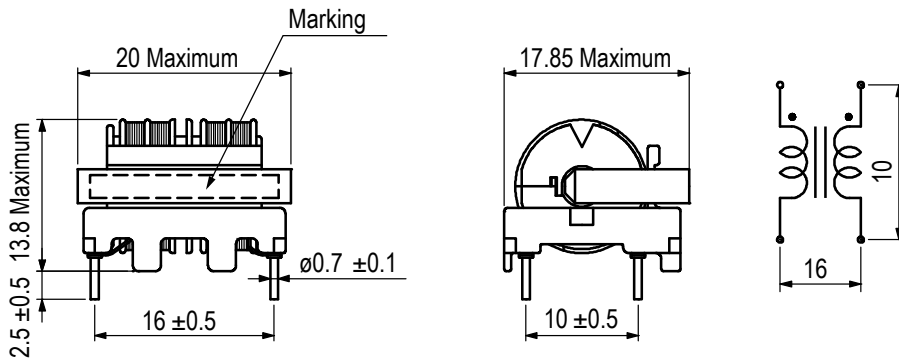

Environmental Compliance

All KEMET AC Line Filters are RoHS Compliant.



RoHS Compliant

Table 1 – Ratings & Part Number Reference

Part Number	Rated Current AC (A)	Inductance (mH) Minimum	DC Resistance/ Line (Ω) Maximum	Temperature Rise (K) Maximum	Wire Diameter (mm)	Marking	Weight (g) Approximate
SS17HB-03225	0.3	22.5	2.60	48	0.20	03 Lot No.	5.9
SS17HB-04125	0.4	12.5	1.40	53	0.23	04 Lot No.	6.5
SS17HB-05100	0.5	10.0	1.10	55	0.25	05 Lot No.	6.4
SS17HB-06085	0.6	8.5	0.84	45	0.28	06 Lot No.	6.0
SS17HB-07065	0.7	6.5	0.70	50	0.30	07 Lot No.	6.0
SS17HB-08050	0.8	5.0	0.45	58	0.30	08 Lot No.	5.9
SS17HB-10025	1.0	2.5	0.38	50	0.37	10 Lot No.	6.3
SS17HB-11020	1.1	2.0	0.24	65	0.37	11 Lot No.	6.3
SS17HB-13018	1.3	1.5	0.18	55	0.40	13 Lot No.	6.2
SS17HB-17008	1.7	0.8	0.12	55	0.45	17 Lot No.	6.1
SS17HB-R03300	0.3	30.0	2.60	48	0.20	R03 Lot No.	5.9
SS17HB-R04170	0.4	17.0	1.40	53	0.23	R04 Lot No.	6.5
SS17HB-R05140	0.5	14.0	1.10	55	0.25	R05 Lot No.	6.4
SS17HB-R06120	0.6	12.0	0.84	45	0.28	R06 Lot No.	6.0
SS17HB-R07090	0.7	9.0	0.70	50	0.30	R07 Lot No.	6.0
SS17HB-R08070	0.8	7.0	0.45	58	0.30	R08 Lot No.	5.9
SS17HB-R10035	1.0	3.5	0.38	50	0.37	R10 Lot No.	6.3
SS17HB-R11025	1.1	2.5	0.24	65	0.37	R11 Lot No.	6.3
SS17HB-R13020	1.3	2.0	0.18	55	0.40	R13 Lot No.	6.2
SS17HB-R17010	1.7	1.0	0.12	55	0.45	R17 Lot No.	6.1

Specifications

Item	SS17HB
Rated Voltage	250 VAC
Withstanding Voltage	2400 VAC (2 seconds, between lines)
Thermal Class	E (120°C)
Operating Temperature Range	-25°C to T (T = 120 - temperature rise)
Inductance Measurement Condition	1 kHz, 1 V, KC530 or equivalent

Frequency Characteristics

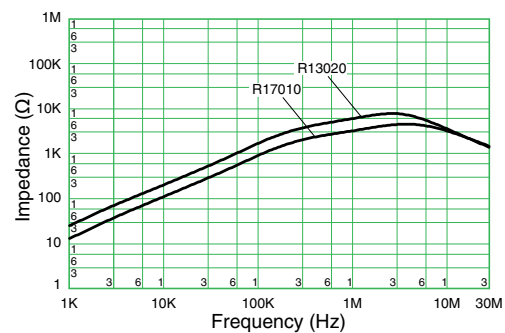
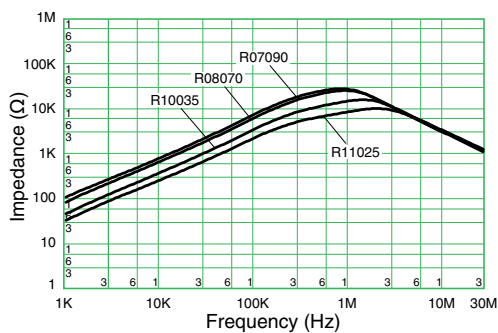
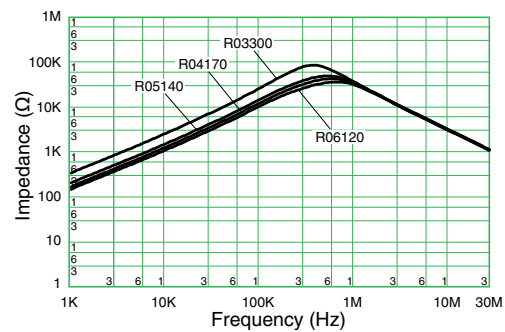
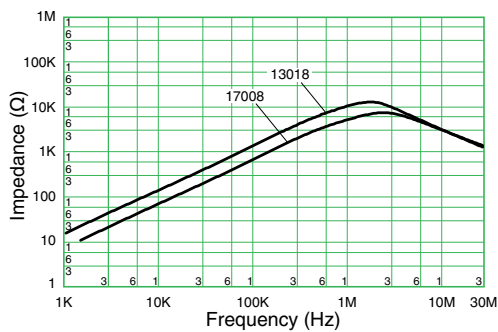
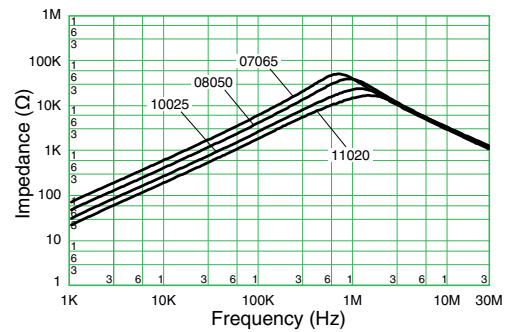
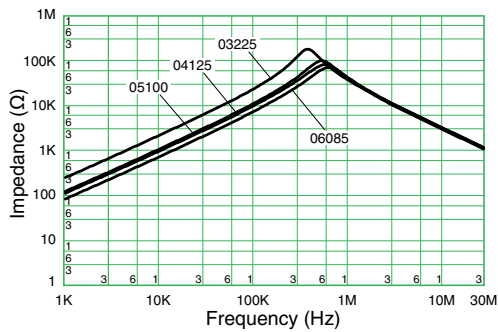

Frequency Characteristics Comparison

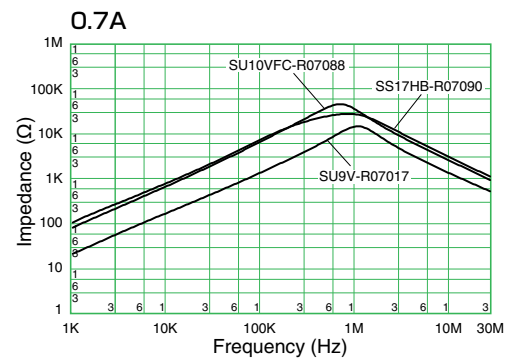
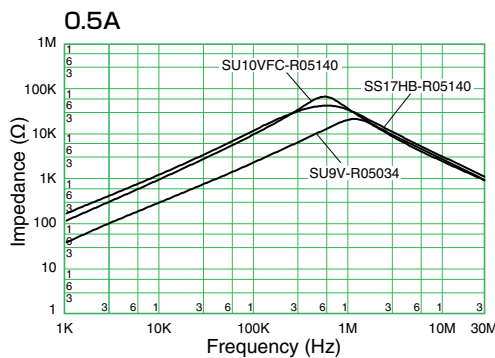
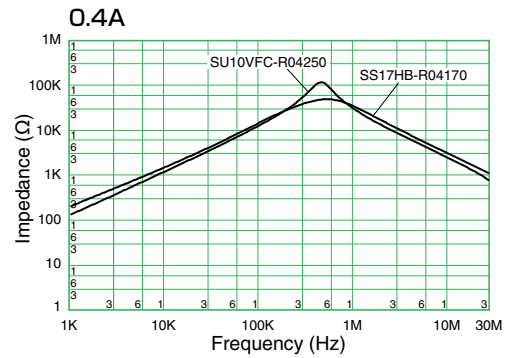
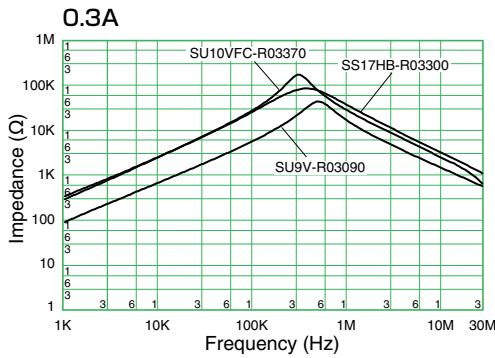
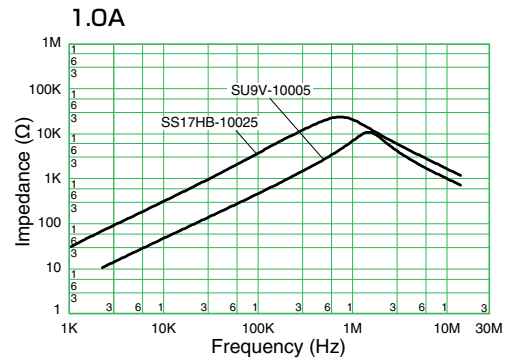
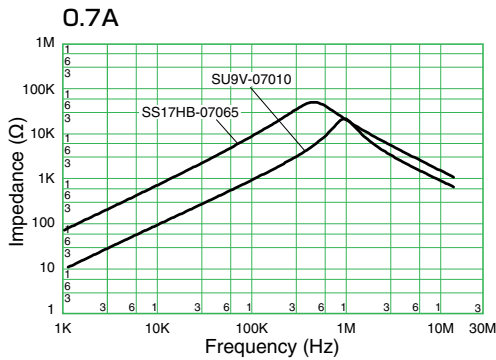
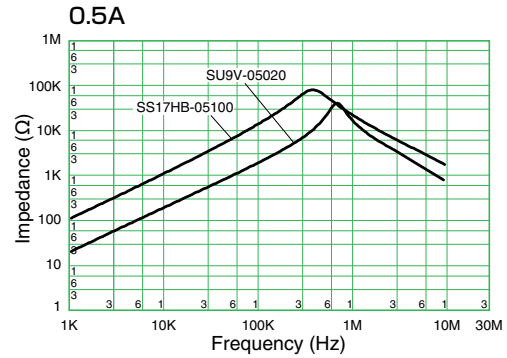
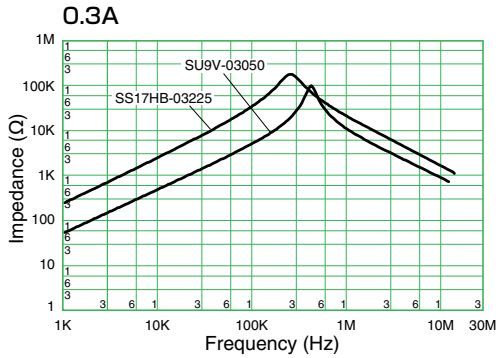

Frequency Characteristics Comparison Cont'd

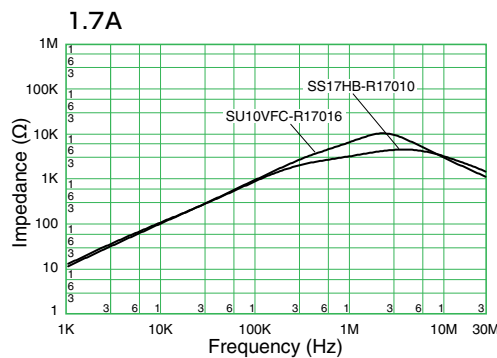
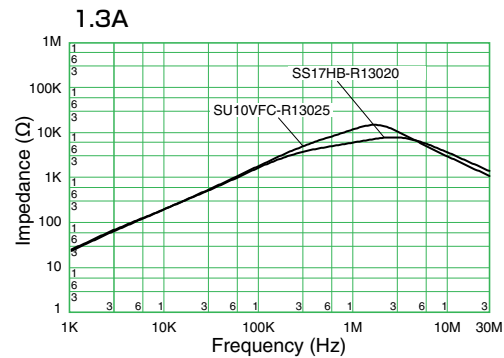
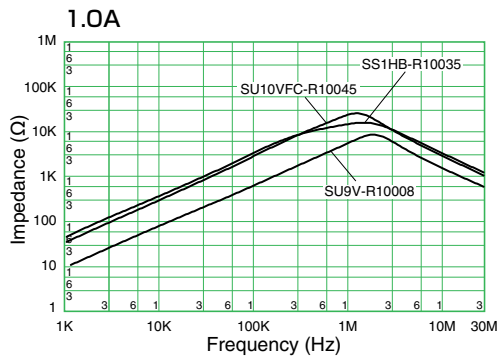

Notes on Use

Shelf Life

- Use within 6 months. If the product is used after a storage period of 6 months or longer, confirm its solderability before use.

Storage Condition

- Avoid storage in high temperature and high humidity environment, as such condition may deteriorate the solderability of external electrode.
- Avoid storage in atmosphere containing toxic gases or acid (e.g., sulphur and chlorine), as such gas may deteriorate the solderability of external electrode.
- Avoid storage near strong magnetic field, as such condition may magnetize the product.

KEMET Corporation World Headquarters

2835 KEMET Way
Simpsonville, SC 29681

Mailing Address:
P.O. Box 5928
Greenville, SC 29606

www.kemet.com
Tel: 864-963-6300
Fax: 864-963-6521

Corporate Offices
Fort Lauderdale, FL
Tel: 954-766-2800

North America

Southeast
Lake Mary, FL
Tel: 407-855-8886

Northeast
Wilmington, MA
Tel: 978-658-1663

Central
Novi, MI
Tel: 248-994-1030

West
Milpitas, CA
Tel: 408-433-9950

Mexico
Guadalajara, Jalisco
Tel: 52-33-3123-2141

Europe

Southern Europe
Paris, France
Tel: 33-1-4646-1006

Sasso Marconi, Italy
Tel: 39-051-939111

Central Europe
Landsberg, Germany
Tel: 49-8191-3350800

Kamen, Germany
Tel: 49-2307-438110

Northern Europe
Bishop's Stortford, United Kingdom
Tel: 44-1279-460122

Espoo, Finland
Tel: 358-9-5406-5000

Asia

Northeast Asia
Hong Kong
Tel: 852-2305-1168

Shenzhen, China
Tel: 86-755-2518-1306

Beijing, China
Tel: 86-10-5829-1711

Shanghai, China
Tel: 86-21-6447-0707

Taipei, Taiwan
Tel: 886-2-27528585

Southeast Asia
Singapore
Tel: 65-6586-1900

Penang, Malaysia
Tel: 60-4-6430200

Bangalore, India
Tel: 91-806-53-76817

Note: KEMET reserves the right to modify minor details of internal and external construction at any time in the interest of product improvement. KEMET does not assume any responsibility for infringement that might result from the use of KEMET Capacitors in potential circuit designs. KEMET is a registered trademark of KEMET Electronics Corporation.

Disclaimer

This product has been made available through a Private Label Agreement and a Development and Cross-Licensing Agreement between KEMET and NEC TOKIN to expand market and product offerings for both companies and their respective customers. For more information, please visit <http://www.kemet.com/nectokin>.

All product specifications, statements, information and data (collectively, the "Information") in this datasheet are subject to change. The customer is responsible for checking and verifying the extent to which the Information contained in this publication is applicable to an order at the time the order is placed.

All Information given herein is believed to be accurate and reliable, but it is presented without guarantee, warranty, or responsibility of any kind, expressed or implied.

Statements of suitability for certain applications are based on KEMET Electronics Corporation's ("KEMET") knowledge of typical operating conditions for such applications, but are not intended to constitute – and KEMET specifically disclaims – any warranty concerning suitability for a specific customer application or use. The Information is intended for use only by customers who have the requisite experience and capability to determine the correct products for their application. Any technical advice inferred from this Information or otherwise provided by KEMET with reference to the use of KEMET's products is given gratis, and KEMET assumes no obligation or liability for the advice given or results obtained.

Although KEMET designs and manufactures its products to the most stringent quality and safety standards, given the current state of the art, isolated component failures may still occur. Accordingly, customer applications which require a high degree of reliability or safety should employ suitable designs or other safeguards (such as installation of protective circuitry or redundancies) in order to ensure that the failure of an electrical component does not result in a risk of personal injury or property damage.

Although all product-related warnings, cautions and notes must be observed, the customer should not assume that all safety measures are indicated or that other measures may not be required.