

Overview

The KEMET ESD-R-B Series solid toroidal cores with snail-shaped case are designed for use on round cable. The wide range of MnZn and NiZn options allows for targeting of specific frequency ranges.

Benefits

- MnZn (≤ 100 MHz, AM band range) and NiZn (≤ 300 MHz, FM band range) options available
- Solid construction
- Case flame resistant rating: UL94V-2

Applications

- Consumer electronics



Turns and Impedance Characteristics

When the desired performance of an EMI core cannot be obtained with a single pass through the core, the impedance characteristics can be changed with multiple turns.

A turn is counted by the number of lead-wire windings which pass through the inner hole of the core. Windings on the outside of the core do not count. See Figure 1 for examples of one, two, and three turns.

Adding turns will result in higher impedance while also lowering the effective frequency range. See Figure 2 for an example.

Core Material and Effective Frequency Range

There are two ferrite material options for KEMET EMI Cores: Nickel-Zinc (Ni-Zn) and Manganese-Zinc (Mn-Zn). Each core material has a different resistance and effective frequency range. The Mn-Zn core material has lower resistance compared to the Ni-Zn; therefore, be sure to provide adequate insulation before use.

For reference, the Ni-Zn core material is typically effective for the frequencies in the MHz band range such as the FM-band, while the Mn-Zn core material is typically effective for the kHz band range such as the AM-band. See Figure 3.

It is recommended to verify actual effectiveness in the target application with measurements.

Figure 1 – How to count turns

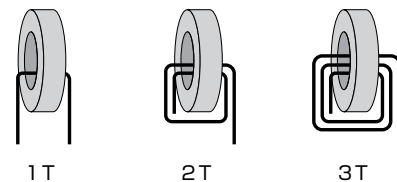

Figure 2 – Relationship between impedance and turn count. (Representative example: ESD-R-16C)

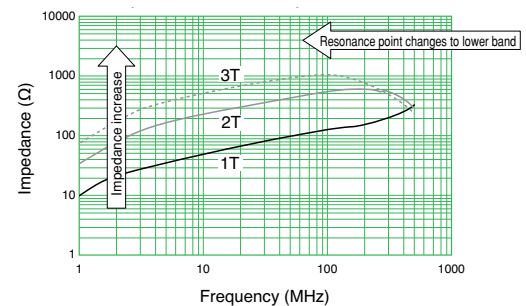
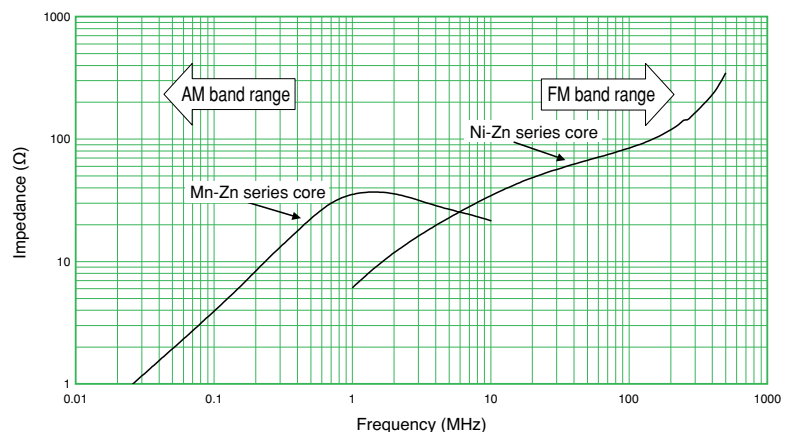
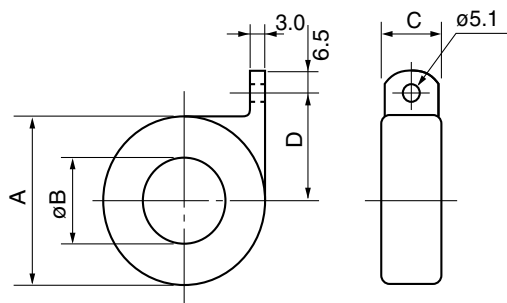

Figure 3 – Effective band range of Mn-Zn and Ni-Zn ferrite core material. (Representative example, measured with same-dimension ring core)



Dimensions – Millimeters



See Table 1 for dimensions

Environmental Compliance

All KEMET EMI cores are RoHS Compliant.



RoHS Compliant

Table 1 – Ratings & Part Number Reference

Part Number	Dimensions (mm)				Frequency Range ¹		Case Color	Compatible Toroidal Core (Bare Type)
	A	B	C	D	≤ 100 MHz (AM band range)	≤ 300 MHz (FM band range)		
ESD-R-19B	21.5	8.8	13.0	18.5	X		White	ESD-R-19S
ESD-R-19D-B	21.5	8.8	13.0	18.5		X	Black	ESD-R-19SD
ESD-R-25B	29.3	13.9	15.0	23.0	X		White	ESD-R-25S
ESD-R-25D-B	29.3	13.9	15.0	23.0		X	Black	ESD-R-25SD
ESD-R-38B	42.4	17.9	16.0	28.0	X		White	ESD-R-38D
ESD-R-38D-B	42.4	17.9	16.0	28.0		X	Black	—
ESD-R-47B	51.5	25.5	17.5	34.0	X		White	—
ESD-R-47D-B	51.5	25.5	17.5	34.0		X	Black	—

¹ Above frequency range is for reference only. Please test with actual device before use.

Impedance vs. Frequency

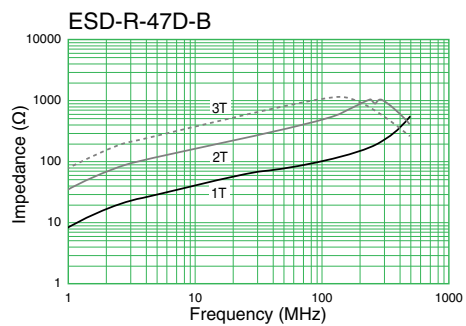
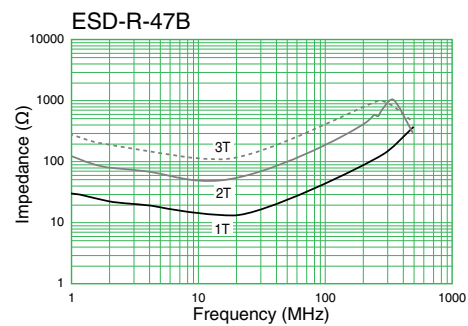
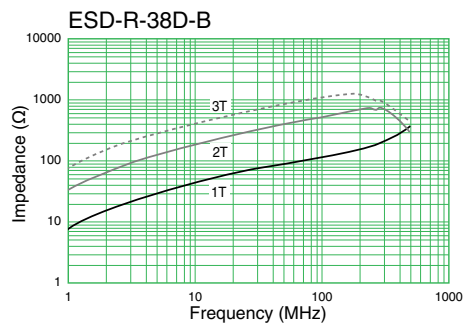
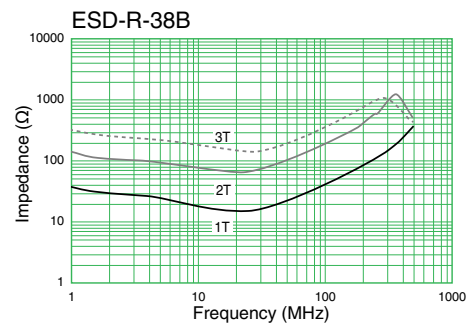
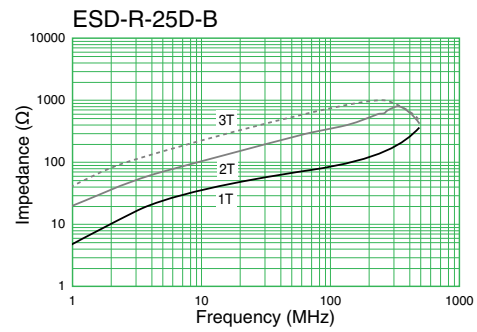
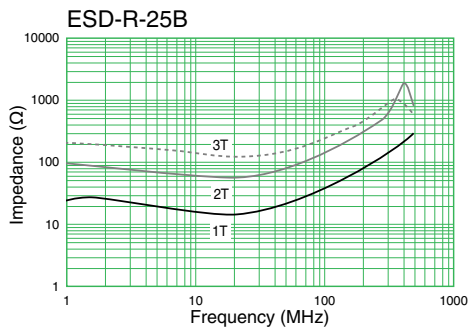
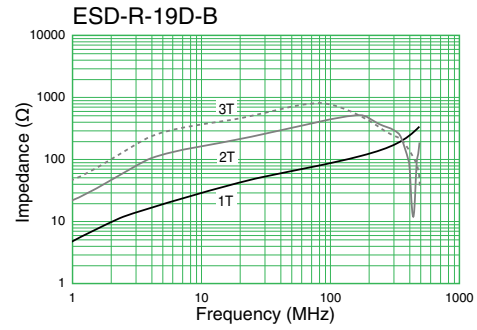
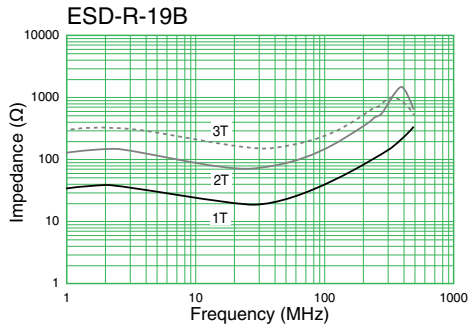

KEMET Corporation World Headquarters

2835 KEMET Way
Simpsonville, SC 29681

Mailing Address:
P.O. Box 5928
Greenville, SC 29606

www.kemet.com
Tel: 864-963-6300
Fax: 864-963-6521

Corporate Offices
Fort Lauderdale, FL
Tel: 954-766-2800

North America

Southeast
Lake Mary, FL
Tel: 407-855-8886

Northeast
Wilmington, MA
Tel: 978-658-1663

Central
Novi, MI
Tel: 248-994-1030

West
Milpitas, CA
Tel: 408-433-9950

Mexico
Guadalajara, Jalisco
Tel: 52-33-3123-2141

Europe

Southern Europe
Paris, France
Tel: 33-1-4646-1006

Sasso Marconi, Italy
Tel: 39-051-939111

Central Europe
Landsberg, Germany
Tel: 49-8191-3350800

Kamen, Germany
Tel: 49-2307-438110

Northern Europe
Bishop's Stortford, United Kingdom
Tel: 44-1279-460122

Espoo, Finland
Tel: 358-9-5406-5000

Asia

Northeast Asia
Hong Kong
Tel: 852-2305-1168

Shenzhen, China
Tel: 86-755-2518-1306

Beijing, China
Tel: 86-10-5829-1711

Shanghai, China
Tel: 86-21-6447-0707

Taipei, Taiwan
Tel: 886-2-27528585

Southeast Asia
Singapore
Tel: 65-6586-1900

Penang, Malaysia
Tel: 60-4-6430200

Bangalore, India
Tel: 91-806-53-76817

Note: KEMET reserves the right to modify minor details of internal and external construction at any time in the interest of product improvement. KEMET does not assume any responsibility for infringement that might result from the use of KEMET Capacitors in potential circuit designs. KEMET is a registered trademark of KEMET Electronics Corporation.

Disclaimer

This product has been made available through a Private Label Agreement and a Development and Cross-Licensing Agreement between KEMET and NEC TOKIN to expand market and product offerings for both companies and their respective customers. For more information, please visit <http://www.kemet.com/nectokin>.

All product specifications, statements, information and data (collectively, the "Information") in this datasheet are subject to change. The customer is responsible for checking and verifying the extent to which the Information contained in this publication is applicable to an order at the time the order is placed.

All Information given herein is believed to be accurate and reliable, but it is presented without guarantee, warranty, or responsibility of any kind, expressed or implied.

Statements of suitability for certain applications are based on KEMET Electronics Corporation's ("KEMET") knowledge of typical operating conditions for such applications, but are not intended to constitute – and KEMET specifically disclaims – any warranty concerning suitability for a specific customer application or use. The Information is intended for use only by customers who have the requisite experience and capability to determine the correct products for their application. Any technical advice inferred from this Information or otherwise provided by KEMET with reference to the use of KEMET's products is given gratis, and KEMET assumes no obligation or liability for the advice given or results obtained.

Although KEMET designs and manufactures its products to the most stringent quality and safety standards, given the current state of the art, isolated component failures may still occur. Accordingly, customer applications which require a high degree of reliability or safety should employ suitable designs or other safeguards (such as installation of protective circuitry or redundancies) in order to ensure that the failure of an electrical component does not result in a risk of personal injury or property damage.

Although all product-related warnings, cautions and notes must be observed, the customer should not assume that all safety measures are indicted or that other measures may not be required.