

# 1890 MHz low power downconverter with 110 MHz I.F.

## Application report

### 1890 MHz LOW POWER DOWNCONVERTER WITH 110 MHz I.F.

#### Introduction

This application note describes the performance of a 1890 MHz low voltage (3 volt) downconverter intended for wireless applications like DECT, PHP and other 1.8-2 GHz applications. The main intention is to demonstrate the superior performance of the new Philips fourth generation RF wideband bipolar transistors used as an RF preamplifier and mixer. In addition, a buffer and oscillator circuit are also included in this design to make it convenient in assessing overall performance. The designs of the RF preamplifier and mixer were treated as more important while that of the oscillator and buffer were not the primary focus.

In determining the performance of a downconverter, several specs are important and the best trade-off between these will depend on the importance of these in the system. The system designer will decide which are the more important: signal handling (linearity), sensitivity (noise figure), supply power (efficiency). This application note includes the design for only one configuration for a cordless telephone (DECT); however other downconverter designs can be derived from this basic design to satisfy the other system requirements.

#### Circuit Design Requirements

The converter block diagram (see fig. 1, next page) is the typical block diagram for a converter suitable in general for any of these systems. A particular system other than DECT may require something different, but the concepts are basically the same.

#### Preselect Filter Requirements

In the block diagram (fig. 1) between A and B and between C and D are the preselect filters, which are included in this design to improve image rejection; to reject out of band signals (such as coming from the transmitter); and to increase isolation from VCO to antenna (necessary for the LO radiation spec to be met). The most frequently used RF filters are made with high dielectric constant ceramic material with low loss tangent. They can be very small in size while maintaining low insertion loss, very important since the loss at the input adds directly to degrade the overall noise figure. The insertion loss of the SMD filters appeared to be around 2 dB. When 1 dB insertion loss filters are used in this application, the overall noise Figure will improve by about 1.5 dB. (Another application board, with low-loss but larger dimension filters is available upon request.)

The number of poles used in the filtering in this design is 4; two 2-pole filters with 1 in front of the RF preamplifier and 1 in the interstage between the RF preamplifier and the mixer. This gives a better trade-off between noise and intermodulation. The input filter might in practice be part of a diplexer between transmitter and receiver or a RF-switch might be included in case of a TDMA system.

The number of poles necessary to get sufficient image rejection depends, of course, very much on the chosen intermediate frequency. The lower the IF, the more selective the filters need to be.



**RF preamplifier Requirements**

The preamplifier (between B and C) is required to improve the downconverter noise figure as the mixer Noise Figure on its own is too high. The preamplifier also helps to improve isolation from VCO to antenna and adds some gain. The amplifier needs to be matched to 50 Ohms, since the bandpass filters require a 50 ohm load for correct functionality.

**Mixer Requirements**

Any of various mixer configurations could be considered. The mixer should provide a linear mixing conversion, i.e. provide an output level at the IF which is in proportion to the RF input signal level. In addition the choice is based on the most important requirements: the isolation required between the LO and the RF input (or points D and E); and the Noise Figure and linearity requirements. Linearity may be expressed by specifying  $IP_3$  (third order intercept point) and/or F.R.S. (first repeated spot) specification; the latter being a measure of inband 2nd order distortion. (This specification is important when the receive band is wide) The mixer should also give sufficient gain so that an additional IF-amplifier would not be required (between G and H).

**VCO and Buffer Requirements**

The VCO should provide a signal with high spectral purity (low phase noise) in order not to degrade receiver sensitivity when strong signals are present in adjacent channels. Requirements for the VCO include a predefined tuning slope and tuning range, and a reproducibility of the center frequency without the requirement for tuning or trimming in production. Also the output level should be sufficient to drive the mixer or buffer while operating at a low current. When the mixer isolation or VCO buffering is not sufficient (causing, either or both, too much leak through of the LO to the antenna and oscillator pulling), a buffer amplifier is necessary. VCO frequency-pulling can be improved considerably by using a well designed buffer amplifier.

1890 MHz low power downconverter with  
 110 MHz I.F.

## Application report

## MAIN SYSTEM CHARACTERISTICS

 $F_{in}$  = 1890 MHz  $F_{out}$  = 110 MHz (FLO = 1780 MHz tuned by means of Vtune)

CHARACTERISTIC	VALUE	REMARKS
CONVERSION POWER GAIN	typ. 20 dB	includes filter losses
NOISE FIGURE	< 9 dB typ. 7 dB	includes losses depends on filters
IP3	typ. -15 dBm	at input
1 dB COMPRESSION	typ. -3 dBm	at output
LO RADIATION	< 1 nW	on RF input
FREQUENCY PULLING	< 50 kHz shift LO	RF input > 12 dBm
IMAGE REJECTION	typ. > 60 dB	imagefreq = 1670 MHz
SUPPLY VOLTAGE	typ. 3.3 V	Vcc1 = Vcc2
SUPPLY CURRENT	typ. 11 mA	mixer/pre = 4 mA LO/ buff = 7 mA
VCO CNR@100 kHz (phase noise)	typ -105 dBcHz	not optimised
REPRODUCABILITY	GAIN +/- 0.5 dB (*)	no alignments
BOARD SIZE	28x16x6 mm 15x23x2 mm	preamp + mix + filt. LO + buffer
PCB material	epoxy FR4 h = 0.5 mm	Er = 4.6
input impedance	50 Ohm	@ 1890 MHz
load impedance	50 Ohm	@ 110 MHz

(\*) with parts of +/- 5% tolerance (filter tolerances not included)

See also the graphs in the appendix.

### Circuit Design

The circuit was built with the following sub-blocks:

1. RF Preamplifier and filters
2. Mixer, IF-Matching
3. VCO and Buffer amp

The circuit diagram is shown in fig. 2

#### **RF preamplifier Design**

The RF preamplifier is designed with the BFG505/x, which is gain optimized for low current in the range 1 to 5 mA. this transistor, in the SOT143 package style, has an  $F_T$  of 9 GHz, a maximum Gain of more than 13 dB at 1900 MHz, and a minimum noise Figure of 1.9 dB at 1900 MHz and 2 mA.

In order to fix the operating point, the choice must be made for the bias current setting to get a certain amount of minimum gain combined with an adequate low noise figure. Once the mixer Noise Figure has been determined (normally between 6 and 10 dB), the best trade-off between gain and noise figure for the preamplifier can also be determined. While, on the one hand, higher preamplifier gain will lower the overall intercept point due to higher mixer drive, more attention is given to a low noise figure for the RF preamplifier, with more attention to high intercept point given to the mixer design.

The DC bias point stabilization is provided with a low cost PNP transistor, which eliminates the influence of  $h_{FE}$  on the bias current setting without using a capacitance bypassed resistor in the emitter lead. At this frequency capacitor bypassing tends towards instability so it is to be avoided. With the PNP transistor biasing method the circuit is unconditionally stable. The preselect filters are mounted on the bottom side of the PCB. When parts count is a critical factor the biasing method can be simplified, yield analysis to predict gain variation is necessary, however.

1890 MHz low power downconverter with  
110 MHz I.F.

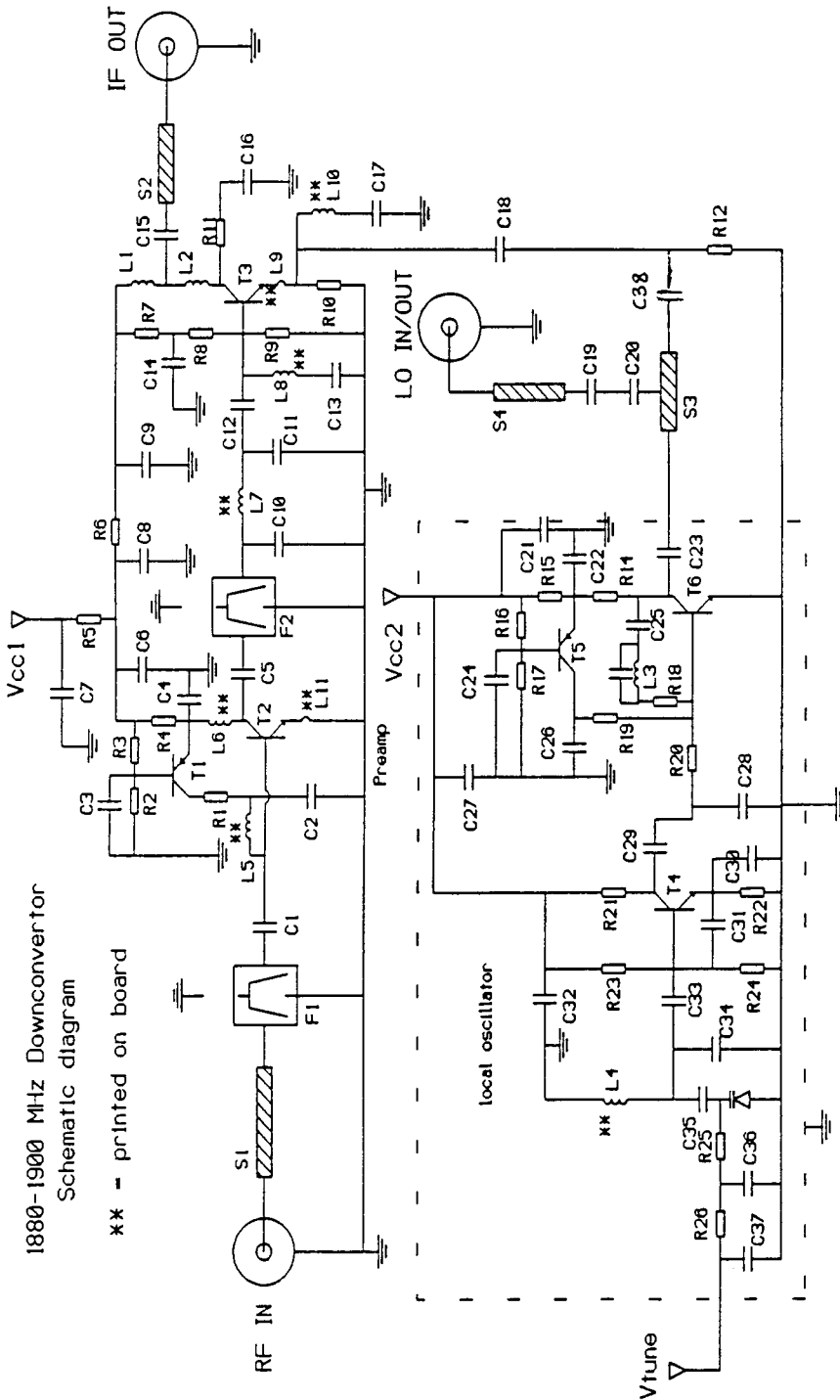

Fig 2. Schematic diagram complete downconverter 107

### Mixer Circuit

A single transistor solution, in this case the BFG505, was chosen for the mixer design with RF input connected to the base and LO to the emitter. This was done to simplify matching, but other configurations would also give comparable performance. (For example, RF and LO both connected to the base terminal). Circuit optimization was done using large-signal CAD analysis based on SPICE modelling. Critical aspects are:

- matching RF port/LO port
- isolation
- instability
- linearity

Matching to the RF is done with a pi-section C6-L7-C8. The LO-port is not matched but by means of a resistors (R12) a properly defined LO drive impedance is made. When another VCO is used, matching to the mixer can easily be achieved with a 3-resistor attenuator. When driven from a 50 ohm source, output impedance of this attenuator should be around 20 Ohms for highest Conversion Gain. For intermediate frequency both base and emitter are capacitive loaded to give highest conversion gain. The value of the emitter decoupling capacitor (C15) should be chosen carefully (could make the circuit unstable, if the wrong value is chosen); resistive feedback is used for DC stabilization. The IF match (L1, L2, C16, C17) transforms the 50 Ohm load impedance into a high impedance. This high impedance at the collector results in a significant gain contribution since the output impedance of the transistor is almost a perfect current source at IF.

If the impedance has to be transformed down to a low load impedance (50 ohms) to the IF output or filter from the high collector impedance, more than one LC sections might be needed, otherwise the bandwidth becomes too narrow and the sensitivity towards component spread high. Gain limitation can be caused by the component tolerance spread, if alignment has to be avoided. A transformation factor of about 30 can be reached with 5% tolerance value components and a double LC section. In this way the 50 Ohm load was transformed into 1.5 kOhm at the collector of the mixer transistor. A 50 Ohm match might be a somewhat unrealistic value for intermediate frequency filters but this theory holds also for other transformation factors. Typically, X-tal filters have a high impedance (1-2 kOhm) and this considerably reduces component count since the double LC-match is not necessary in this case. DECT IF filters are typically SAW filters, and those filters have a 50 Ohm impedance.

Favourably the collector impedance should be ohmic at very high frequencies. This is done by means of R11/C16. A too inductive load here can lead towards instability. This method also eliminates gain variations caused by the parasitic impedances of the SMD coils at 1900 MHz. Observe the specifications of the mixer on the next page. The mixer design was optimized using CAD tools for a DC-current of 1.8 mA.

# 1890 MHz low power downconverter with 110 MHz I.F.

## Application report

Measured characteristics of this mixer amp

CONVERSION POWER GAIN	12 dB	
IP3	-5 dBm	input, LO=-4 dBm
SSB NOISE FIGURE	9 dB	LO=-4 dBm
DC-current	2.0 mA	
load imp. collector	1.5 kOhm	transf. factor =30
LO source impedance	50 Ohm	

### Local Oscillator and buffer

The bufferamp is designed to have 0 dB of gain, to act also as limiter and to have high isolation. The isolation is important to improve the frequency pulling and also to improve the intercept point of the downconverter. If the isolation of the buffer amp is too low this can cause modulation of the oscillator by the RF input spectrum, and the resulting FM-sidebands will be seen as linearity reduction. To increase the isolation of the buffer a neutralizing coil (L4) was added which tunes out the feedback capacitance of the RF transistor. This improves the buffer isolation by as much as 15 dB without making it unstable. Another solution that may work better is the use of a cascoded transistor stage as the buffer. A small coil (L3) is used for better match between buffer and mixer transistor. This coil can also be printed on board due to its low value (12 nH) but in the application a SMD coil was used.

The VCO design used is a straightforward common collector (colpitts) design. The BFG505/X transistor was used as the VCO as its low capacitances assure high frequency operation. Even with the small size printed coil on FR4 used as resonator a phase noise of -105 dBcHz at 100 kHz offset was obtained, which is satisfactory for most digital systems. When a better phase noise is required, using the BFG520 transistor together with a high Q resonator is advised.

### Testing Mixer/Preamplifier

In order to measure the performance of the mixer/preamp separately, it is necessary to remove the jumper on the PCB and to change C20 into 8p2 (was 1p0). The LO output (normally intended for prescaler/synthesizer) can be used as the input. Some matching has to be applied since the LO-input is not matched to 50 Ohm, disturbing the LO-signal because of reflections when fed from an external source. A three resistor attenuator can be applied. The oscillator should be turned off by means of removing the 10 Ohm resistor between Vcc1 and Vcc2.

A supply of 3.3 Volt should be connected to Vcc1. When the converter is used in a TDMA system, the capacitors of 10 nF can be replaced by 1 nF to enhance supply switching time. Results of measurements and board layout are in the appendices



**Appendices:**

**Appendix A1: Board layout total, backside**

**Appendix A2: " " preamp + mixer (detail)**

**Appendix A3: " " VCO + buffer (detail)**

**Appendix B : components list**

**Appendix C : typical measurements results**

Appendix A1 Board layout total (Backside)

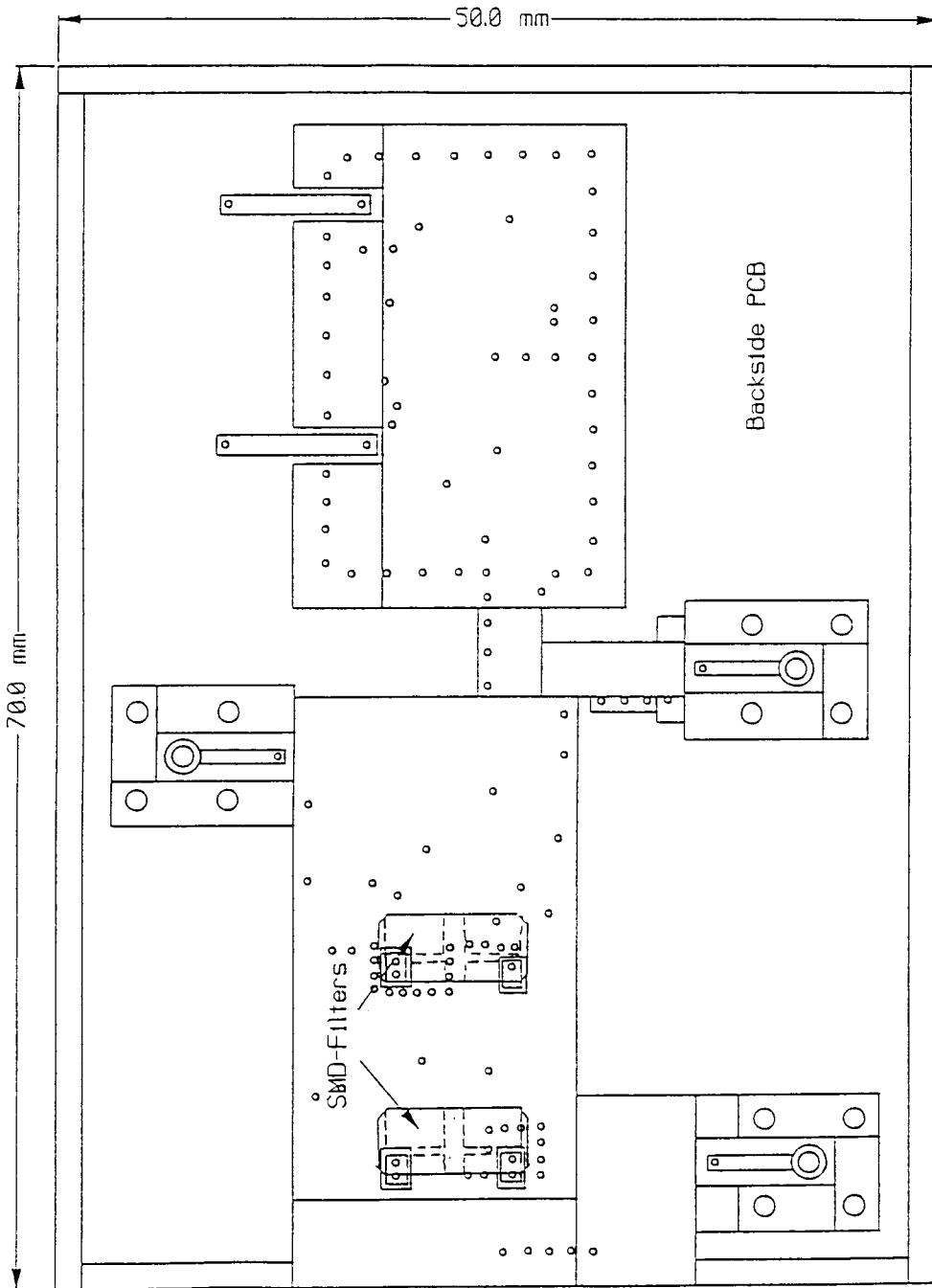

1890 MHz low power downconverter with  
110 MHz I.F.

Application report

Appendix A2 Board layout preamp + mixer (detail)

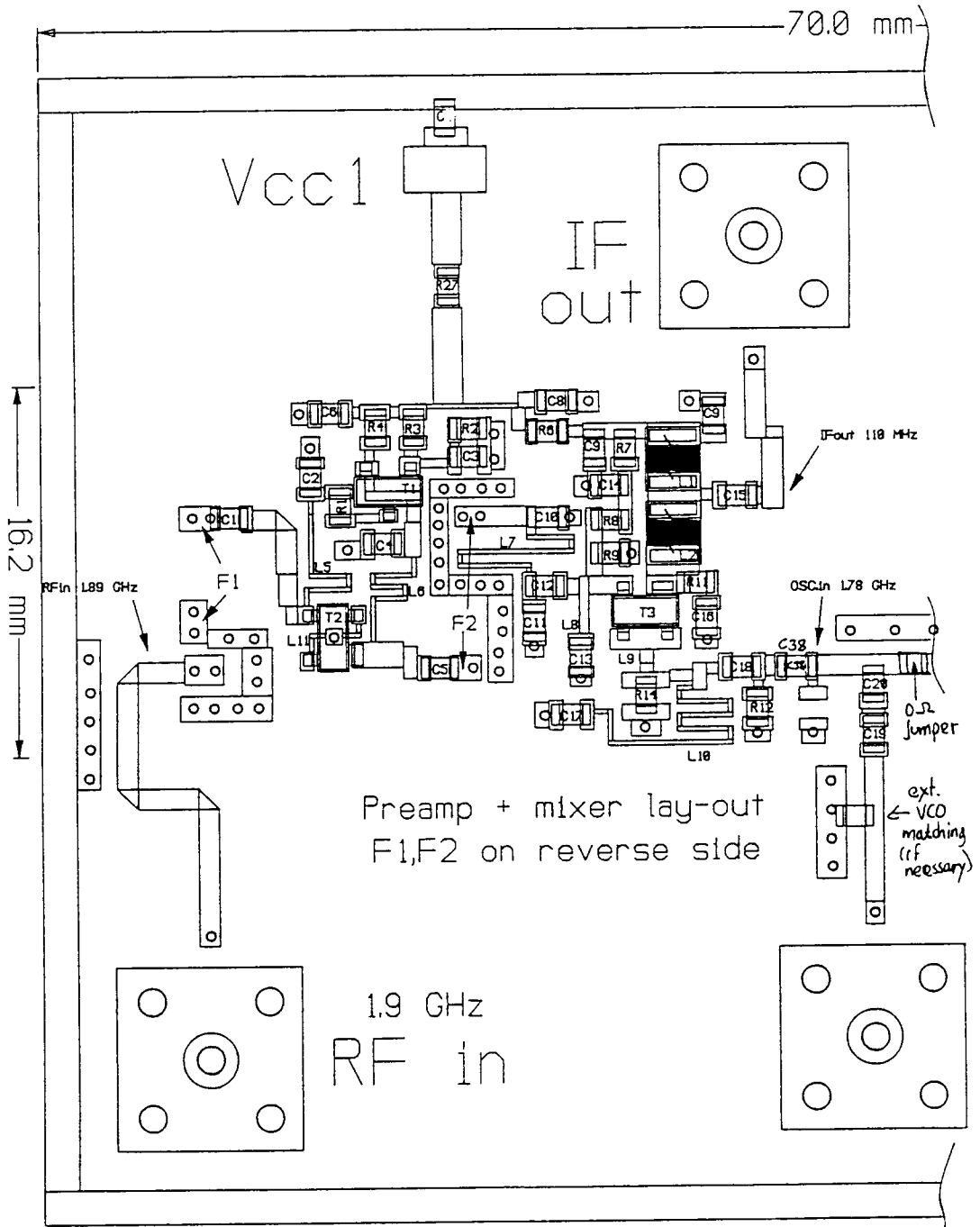

1890 MHz low power downconverter with  
110 MHz I.F.

Application report

Appendix A3 Board layout VCO + buffer (detail)

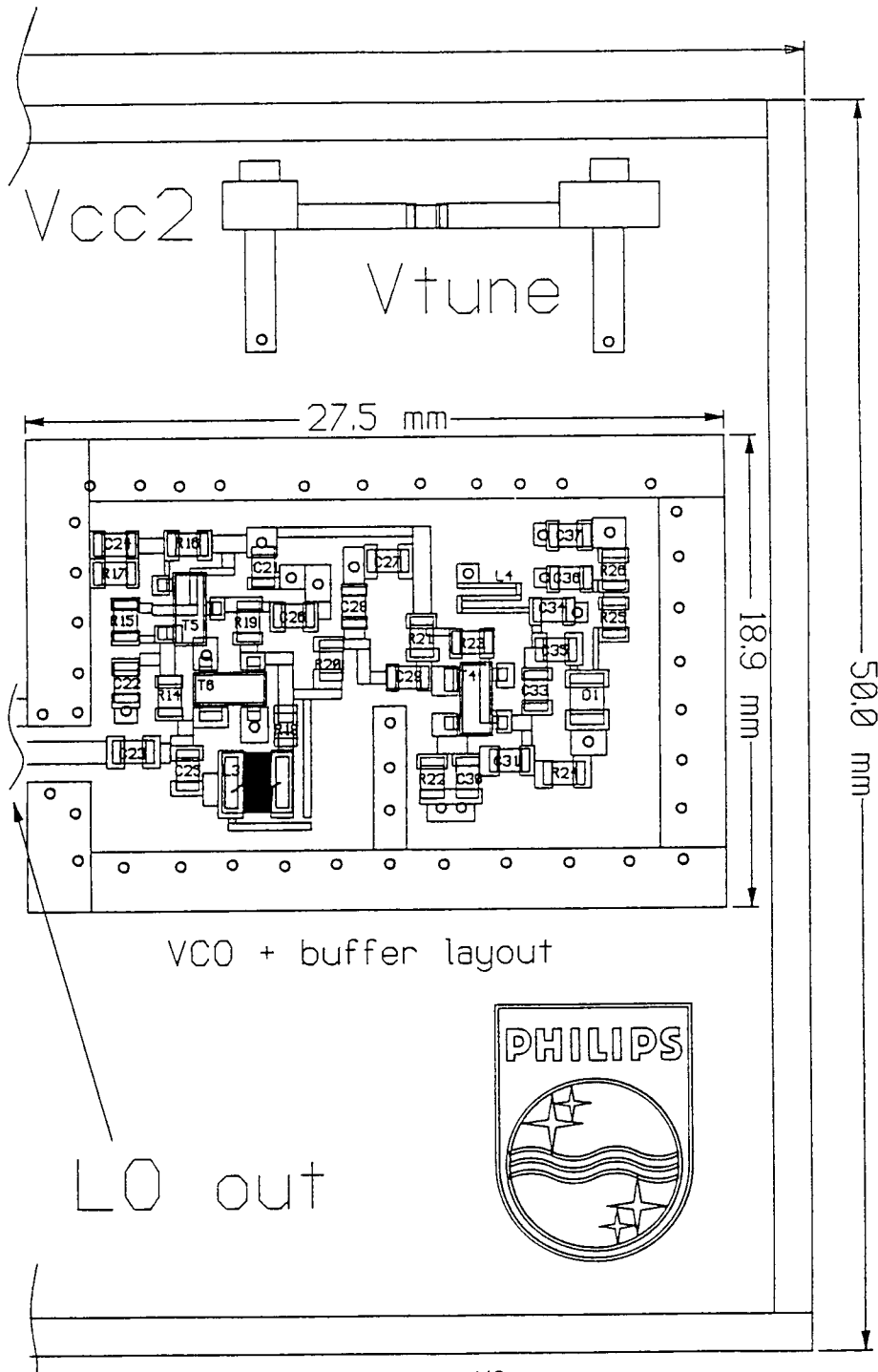

# 1890 MHz low power downconverter with 110 MHz I.F.

## Application report

### Appendix B Components list

#### Capacitors

C3, C6, C7, C8, C9, C14, C21, C22,	
C24, C26, C27, C32, C36, C37.....	10nF
C1, C5, C38.....	2p2
C2, C4, C12, C19.....	8p2
C10.....	0p56
C29, C11.....	1p5
C17.....	82pF
C15, C16.....	4p7
C20, C33.....	1p0
C23, C38.....	10pF
C30.....	1P0
C31.....	0P56
C33.....	1p2
C34.....	omitted
C35.....	0p82
C37.....	3p9
C18.....	2p7
C25, C28, C13.....	1 nF

#### Resistors

R1, R2, R9.....	5k6
R3, R11, R19.....	2k7
R4.....	390
R5.....	27
R6.....	22
R7.....	1k8
R8, R24, R23.....	8k2
R10, R15, R22.....	220
R12.....	47
R14.....	330
R16.....	1k8
R17.....	3k3
R18.....	15
R20.....	12
R21.....	180
R25.....	2k7
R26.....	100k

#### Coils, filters

L1.....	270 nH SMD 1008		
L2.....	1000 nH SMD 1008		
L3.....	18 nH SMD 0805		
L4-L11.....	on PCB		
(L4=5 nH; L5=5.5 nH; L6=5 nH; L7=8 nH L8=2 nH; L9=0.7nH; L10=12nH; L11=0.5 nH)			
F1, F2.....	Siemens	2-pole	SMD
(Siemens type B69812-N1897-A320)			

#### Semiconductors

T1, T5.....	BC807	(5DP)
T2, T4, T6.....	BFG505X	(N39)
T3.....	BFG505	(N33)
D1.....	BB131	

Appendix C

Conv. Gain vs. RF frequency  
Fixed IF Frequency- 110 MHz

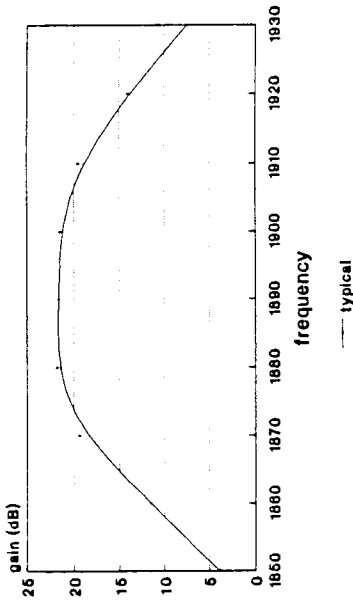

Vcc=3.30 Volt (L.O. tuned)

Conv. Gain vs. input power  
Fixed RF Frequency- 1890 MHz

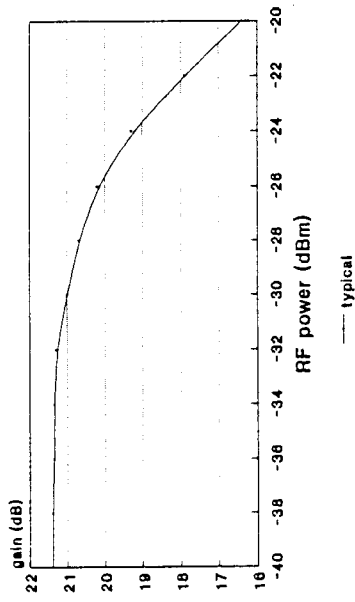

Vcc=3.30 Volt

Conv. Gain vs. IF frequency  
Fixed RF Frequency- 1890 MHz

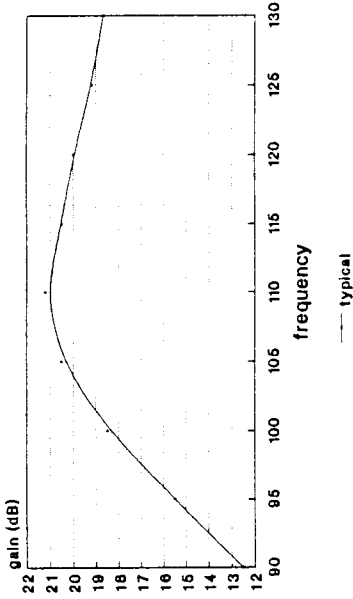

Vcc=3.30 Volt (L.O. tuned)

NOISE FIGURE vs. RF frequency  
Fixed IF Frequency- 110 MHz

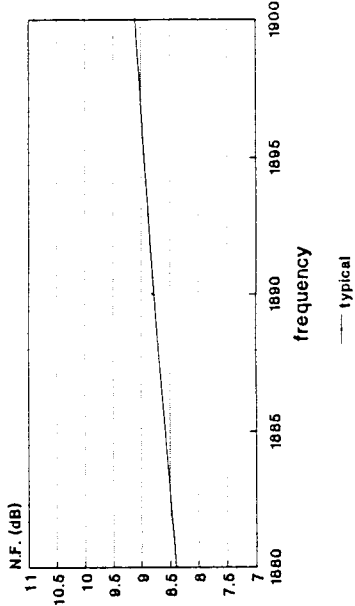

Vcc=3.30 Volt HP6970B