

**ebm-papst St. Georgen GmbH & Co. KG**

Hermann-Papst-Straße 1

D-78112 St. Georgen

Phone +49 7724 81-0

Fax +49 7724 81-1309

info2@de.ebmpapst.com

www.ebmpapst.com

Nominal data

Type	612 NHH-118	
Nominal voltage	VDC	12
Nominal voltage range	VDC	8 .. 15
Speed	min ⁻¹	6800
Power input	W	2.9
Min. ambient temperature	°C	-20
Max. ambient temperature	°C	70
Air flow	m ³ /h	56
Sound power level	B	5.7
Sound pressure level	dB(A)	41

ml = max. load · me = max. efficiency · fa = running at free air · cs = customer specs · cu = customer unit
 Subject to alterations

Technical features

General description	<p>Particular design features: Ball bearings and sleeve bearings available. Some models suitable for use at high ambient temperatures up to 85 °C.</p> <p>General features: Material: fibreglass-reinforced plastic. Impeller PA, housing PBT. Electronic commutation completely integrated. Protected against reverse polarity and locking. Connection via single strands AWG 22, TR 64, bared and tin-plated. Air exhaust over bars. Rotational direction clockwise looking at rotor. Mass: 66 g.</p>
Mass	0.066 kg
Dimensions	60 x 60 x 25 mm
Material of impeller	Fiberglass-reinforced PA plastic
Housing material	Fiberglass-reinforced PBTP plastic
Direction of air flow	Air exhaust over bars
Direction of rotation	Right, looking at rotor
Bearing	Ball bearings
Lifetime L10 at 40 °C	60000 h
Lifetime L10 at maximum temperature	30000 h
Connection line	Single strands AWG 22, TR 64, bared and tin-plated.
Motor protection	Protected against reverse polarity and locking.
Locked-rotor protection	With electronic blocking and overload protection
Approval	VDE, CSA, UL, CE

Product drawing

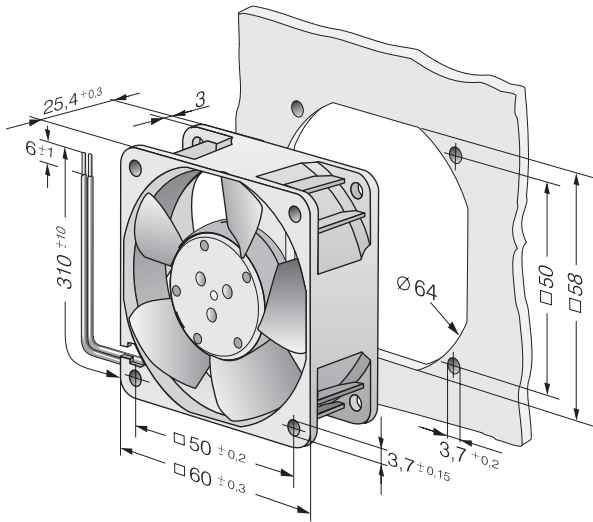

Charts: Air flow

