

### Main product characteristics

$I_{F(AV)}$	15 A
$V_{RRM}$	45 V
$T_j$ (max)	175° C
$V_F$ (max)	0.57 V

### Features and Benefits

- Very small conduction losses
- Negligible switching losses
- Extremely fast switching
- Insulated package: TO-220FPAC  
insulating voltage = 2000V DC  
capacitance = 12 pF
- Avalanche capability specified

### Description

Single chip Schottky rectifier suited for Switch Mode Power Supply and high frequency DC to DC converters.

Packaged in TO-220AC, TO-220FPAC, I<sup>2</sup>PAK or D<sup>2</sup>PAK, this device is intended for use in low voltage, high frequency inverters, free wheeling and polarity protection applications.

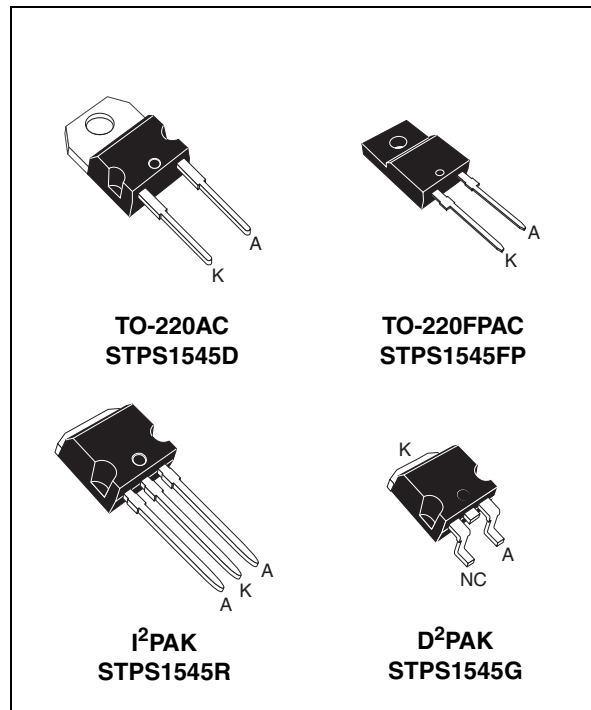

# 1 Characteristics

**Table 1. Absolute Ratings (limiting values)**

Symbol	Parameter		Value	Unit
V <sub>RRM</sub>	Repetitive peak reverse voltage		45	V
I <sub>F(RMS)</sub>	RMS forward voltage		30	A
I <sub>F(AV)</sub>	Average forward current δ = 0.5	TO-220AC I <sup>2</sup> PAK, D <sup>2</sup> PAK	15	A
I <sub>FSM</sub>	Surge non repetitive forward current	t <sub>p</sub> = 10 ms Sinusoidal	220	A
I <sub>RRM</sub>	Peak repetitive reverse current	t <sub>p</sub> = 2 μs square F = 1 kHz	1	A
I <sub>RSM</sub>	Non repetitive peak reverse current	t <sub>p</sub> = 100 μs square	3	A
P <sub>ARM</sub>	Repetitive peak avalanche power	t <sub>p</sub> = 1 μs T <sub>j</sub> = 25°C	6000	W
T <sub>stg</sub>	Storage temperature range		-65 to + 175	°C
T <sub>j</sub>	Maximum operating junction temperature <sup>(1)</sup>		175	°C
dV/dt	Critical rate of rise of reverse voltage		10000	V/μs

1.  $\frac{dP_{tot}}{dT_j} < \frac{1}{R_{th(j-a)}}$  thermal runaway condition for a diode on its own heatsink

**Table 2. Thermal resistances**

Symbol	Parameter		Value	Unit
R <sub>th(j-c)</sub>	Junction to case	TO-220AC, I <sup>2</sup> PAK, D <sup>2</sup> PAK	1.6	°C/W
		TO-220FPAC	4.0	

**Table 3. Static electrical characteristics (per diode)**

Symbol	Parameter	Test Conditions		Min.	Typ.	Max.	Unit
I <sub>R</sub> <sup>(1)</sup>	Reverse leakage current	T <sub>j</sub> = 25°C	V <sub>R</sub> = V <sub>RRM</sub>			200	μA
		T <sub>j</sub> = 125°C			11	40	mA
V <sub>F</sub> <sup>(1)</sup>	Forward voltage drop	T <sub>j</sub> = 125°C	I <sub>F</sub> = 15 A		0.5	0.57	V
		T <sub>j</sub> = 25°C	I <sub>F</sub> = 30 A			0.84	
		T <sub>j</sub> = 125°C	I <sub>F</sub> = 30 A		0.65	0.72	

1. Pulse test: t<sub>p</sub> = 380 μs, δ < 2%

To evaluate the conduction losses use the following equation:

$$P = 0.42 \times I_{F(AV)} + 0.01 I_{F(RMS)}^2$$

**Figure 1. Average forward power dissipation versus average forward current**

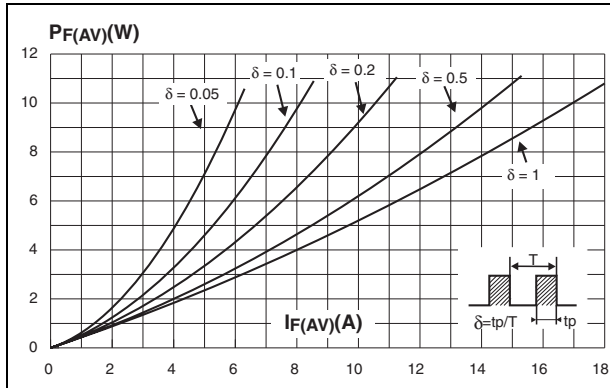

**Figure 2. Average forward current versus ambient temperature ( $\delta = 0.5$ )**

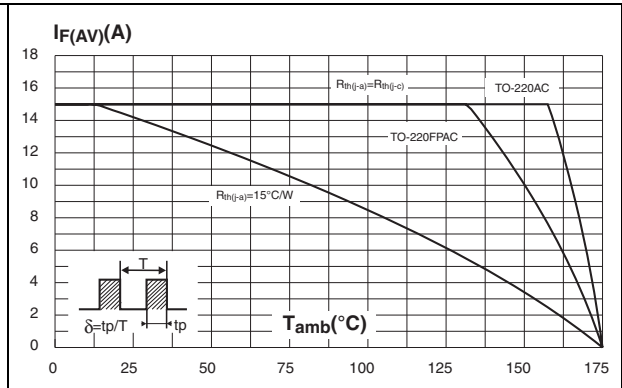

**Figure 3. Normalized avalanche power derating versus pulse duration**

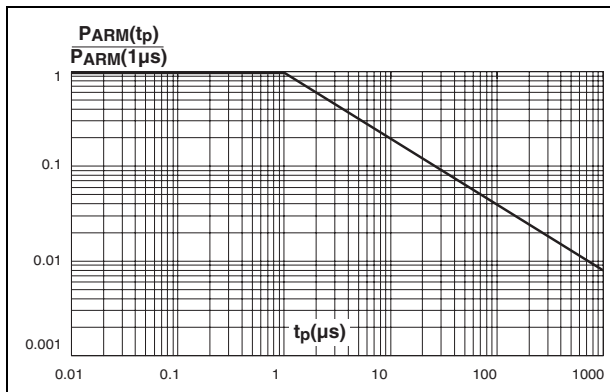

**Figure 4. Normalized avalanche power derating versus junction temperature**

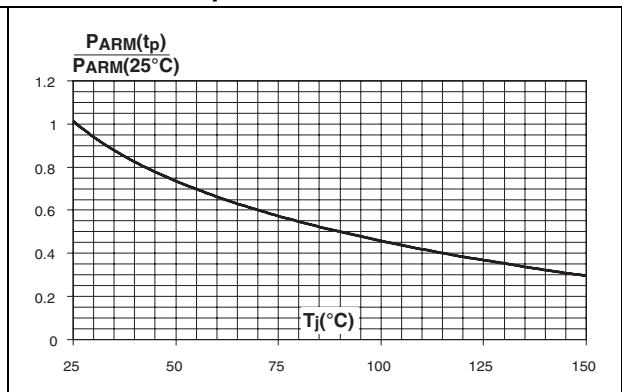

**Figure 5. Non repetitive surge peak forward current versus overload duration (maximum values) (TO-220AC, I<sup>2</sup>PAK D<sup>2</sup>PAK)**

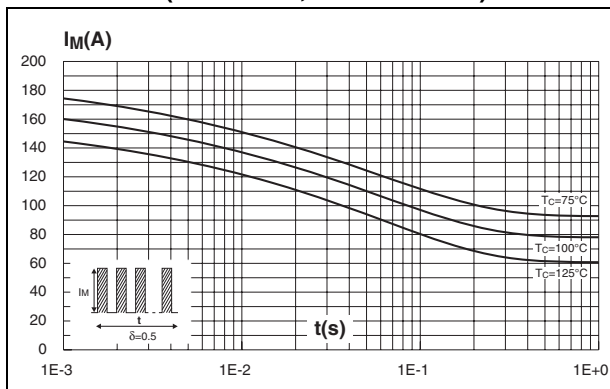

**Figure 6. Non repetitive surge peak forward current versus overload duration (maximum values) (TO-220FPAC)**

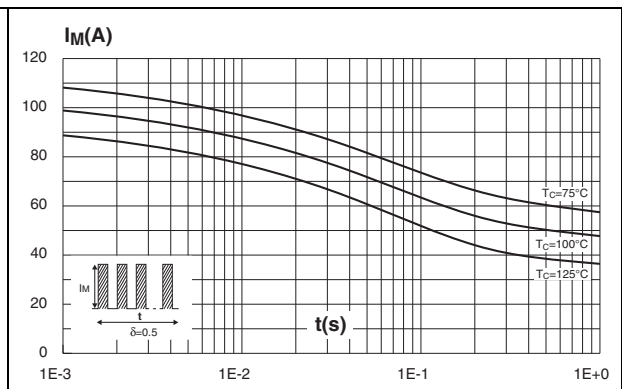

**Figure 7. Relative variation of thermal impedance junction to case versus pulse duration (TO-220AC, I<sup>2</sup>PAK D<sup>2</sup>PAK)**

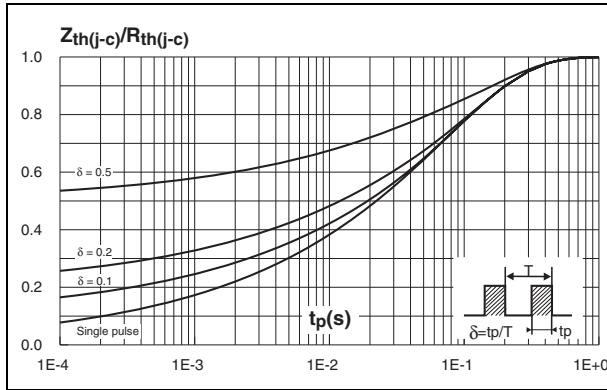

**Figure 8. Relative variation of thermal impedance junction to case versus pulse duration (TO-220FPAC)**

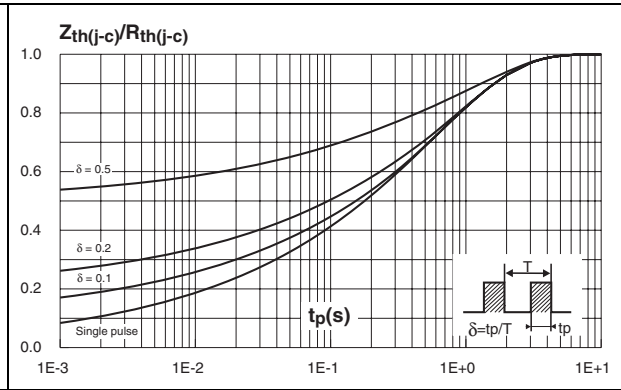

**Figure 9. Reverse leakage current versus reverse voltage applied (typical values)**

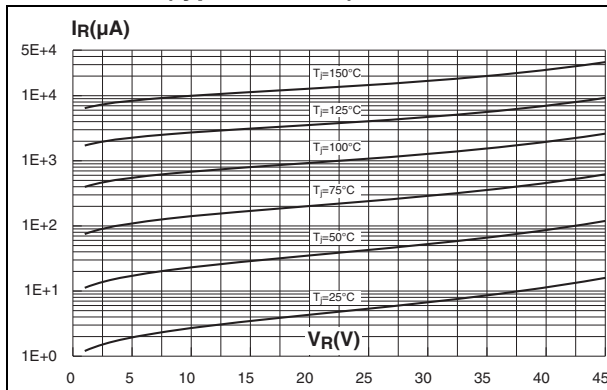

**Figure 10. Junction capacitance versus reverse voltage applied (typical values)**

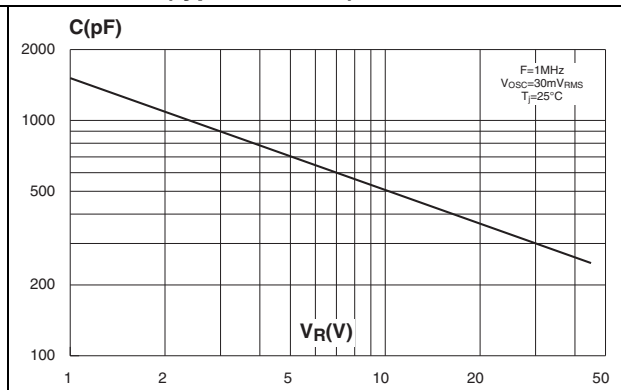

**Figure 11. Forward voltage drop versus forward current (maximum values)**

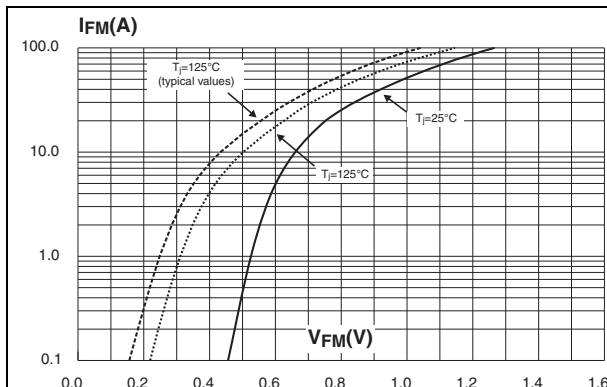

**Figure 12. Thermal resistance junction to ambient versus copper surface under tab (Epoxy printed circuit board FR4, Cu=35  $\mu m$ ) (D<sup>2</sup>PAK)**

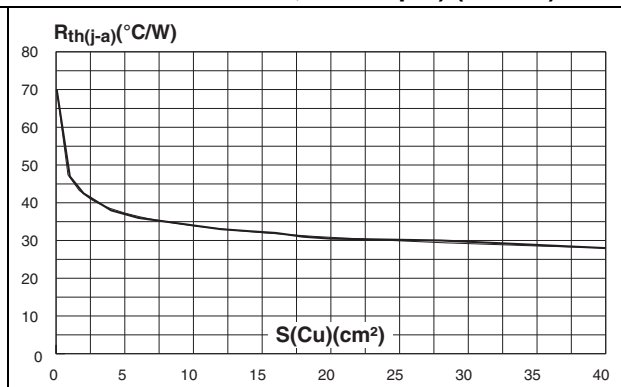

## 2 Package Information

- Epoxy meets UL94, V0
- Cooling method: by conduction (C)
- Recommended torque value: 0.55 Nm
- Maximum torque value: 0.7 Nm

**Table 4. TO-220FPAC dimensions**

Ref	Dimensions			
	Millimeters		Inches	
	Min.	Max.	Min.	Max.
A	4.4	4.6	0.173	0.181
B	2.5	2.7	0.098	0.106
D	2.5	2.75	0.098	0.108
E	0.45	0.70	0.018	0.027
F	0.75	1	0.030	0.039
F1	1.15	1.70	0.045	0.067
F2	1.15	1.70	0.045	0.067
G	4.95	5.20	0.195	0.205
G1	2.4	2.7	0.094	0.106
H	10	10.4	0.393	0.409
L2	16 Typ.		0.63 Typ.	
L3	28.6	30.6	1.126	1.205
L4	9.8	10.6	0.386	0.417
L5	2.9	3.6	0.114	0.142
L6	15.9	16.4	0.626	0.646
L7	9.00	9.30	0.354	0.366
Dia.	3.00	3.20	0.118	0.126

Table 5. I<sup>2</sup>PAK dimensions

Ref	Dimensions			
	Millimeters		Inches	
	Min.	Max.	Min.	Max.
A	4.40	4.60	0.173	0.181
A1	2.49	2.69	0.098	0.106
b	0.70	0.93	0.028	0.037
b1	1.14	1.17	0.044	0.046
b2	1.14	1.17	0.044	0.046
c	0.45	0.60	0.018	0.024
c2	1.23	1.36	0.048	0.054
D	8.95	9.35	0.352	0.368
e	2.40	2.70	0.094	0.106
E	10.0	10.4	0.394	0.409
L	13.1	13.6	0.516	0.535
L1	3.48	3.78	0.137	0.149
L2	1.27	1.40	0.050	0.055

Table 6. D<sup>2</sup>PAK Package dimensions

Ref	Dimensions			
	Millimeters		Inches	
	Min.	Max.	Min.	Max.
A	4.40	4.60	0.173	0.181
A1	2.49	2.69	0.098	0.106
A2	0.03	0.23	0.001	0.009
B	0.70	0.93	0.027	0.037
B2	1.14	1.70	0.045	0.067
C	0.45	0.60	0.017	0.024
C2	1.23	1.36	0.048	0.054
D	8.95	9.35	0.352	0.368
E	10.00	10.40	0.393	0.409
G	4.88	5.28	0.192	0.208
L	15.00	15.85	0.590	0.624
L2	1.27	1.40	0.050	0.055
L3	1.40	1.75	0.055	0.069
M	2.40	3.20	0.094	0.126
R	0.40 typ.		0.016 typ.	

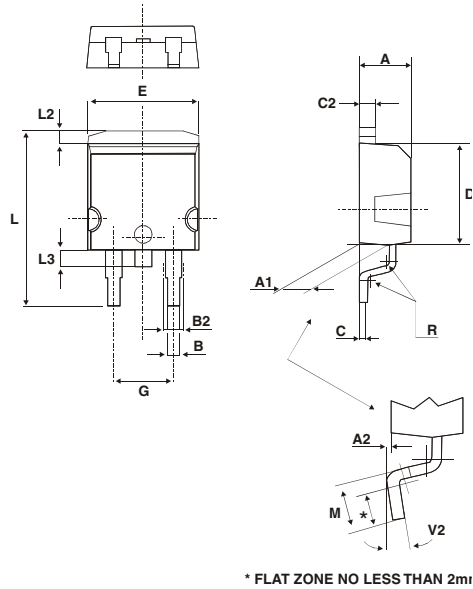

Figure 13. Footprint (dimensions in millimeters)

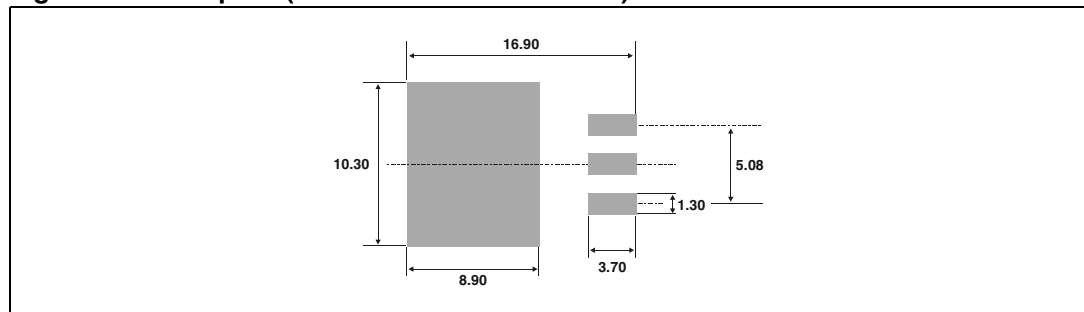

Table 7. TO-220AC dimensions

Ref	Dimensions			
	Millimeters		Inches	
	Min.	Max.	Min.	Max.
A	4.40	4.60	0.173	0.181
C	1.23	1.32	0.048	0.051
D	2.40	2.72	0.094	0.107
E	0.49	0.70	0.019	0.027
F	0.61	0.88	0.024	0.034
F1	1.14	1.70	0.044	0.066
F2	1.14	1.70	0.044	0.066
G	4.95	5.15	0.194	0.202
G1	2.40	2.70	0.094	0.106
H2	10	10.40	0.393	0.409
L2	16.4 typ.		0.645 typ.	
L4	13	14	0.511	0.551
L5	2.65	2.95	0.104	0.116
L6	15.25	15.75	0.600	0.620
L7	6.20	6.60	0.244	0.259
L9	3.50	3.93	0.137	0.154
M	2.6 typ.		0.102 typ.	
Diam.	3.75	3.85	0.147	0.151

In order to meet environmental requirements, ST offers these devices in ECOPACK® packages. These packages have a lead-free second level interconnect. The category of second level interconnect is marked on the package and on the inner box label, in compliance with JEDEC Standard JESD97. The maximum ratings related to soldering conditions are also marked on the inner box label. ECOPACK is an ST trademark. ECOPACK specifications are available at: [www.st.com](http://www.st.com).



### 3 Ordering Information

Ordering type	Marking	Package	Weight	Base qty	Delivery mode
STPS1545D	STPS1545D	TO-220AC	1.86 g	50	Tube
STPS1545FP	STPS1545FP	TO-220FPAC	1.9 g	50	Tube
STPS1545R	STPS1545R	I <sup>2</sup> PAK	1.7 g	50	Tube
STPS1545G	STPS1545G	D <sup>2</sup> PAK	1.48 g	50	Tube
STPS1545G-TR	STPS1545G	D <sup>2</sup> PAK	1.48 g	1000	Tape & Reel

### 4 Revision history

Date	Revision	Description of Changes
Jul-2003	5F	Last release.
21-Mar-2007	6	Removed ISOWATT package.

**Please Read Carefully:**

Information in this document is provided solely in connection with ST products. STMicroelectronics NV and its subsidiaries ("ST") reserve the right to make changes, corrections, modifications or improvements, to this document, and the products and services described herein at any time, without notice.

All ST products are sold pursuant to ST's terms and conditions of sale.

Purchasers are solely responsible for the choice, selection and use of the ST products and services described herein, and ST assumes no liability whatsoever relating to the choice, selection or use of the ST products and services described herein.

No license, express or implied, by estoppel or otherwise, to any intellectual property rights is granted under this document. If any part of this document refers to any third party products or services it shall not be deemed a license grant by ST for the use of such third party products or services, or any intellectual property contained therein or considered as a warranty covering the use in any manner whatsoever of such third party products or services or any intellectual property contained therein.

**UNLESS OTHERWISE SET FORTH IN ST'S TERMS AND CONDITIONS OF SALE ST DISCLAIMS ANY EXPRESS OR IMPLIED WARRANTY WITH RESPECT TO THE USE AND/OR SALE OF ST PRODUCTS INCLUDING WITHOUT LIMITATION IMPLIED WARRANTIES OF MERCHANTABILITY, FITNESS FOR A PARTICULAR PURPOSE (AND THEIR EQUIVALENTS UNDER THE LAWS OF ANY JURISDICTION), OR INFRINGEMENT OF ANY PATENT, COPYRIGHT OR OTHER INTELLECTUAL PROPERTY RIGHT.**

**UNLESS EXPRESSLY APPROVED IN WRITING BY AN AUTHORIZED ST REPRESENTATIVE, ST PRODUCTS ARE NOT RECOMMENDED, AUTHORIZED OR WARRANTED FOR USE IN MILITARY, AIR CRAFT, SPACE, LIFE SAVING, OR LIFE SUSTAINING APPLICATIONS, NOR IN PRODUCTS OR SYSTEMS WHERE FAILURE OR MALFUNCTION MAY RESULT IN PERSONAL INJURY, DEATH, OR SEVERE PROPERTY OR ENVIRONMENTAL DAMAGE. ST PRODUCTS WHICH ARE NOT SPECIFIED AS "AUTOMOTIVE GRADE" MAY ONLY BE USED IN AUTOMOTIVE APPLICATIONS AT USER'S OWN RISK.**

Resale of ST products with provisions different from the statements and/or technical features set forth in this document shall immediately void any warranty granted by ST for the ST product or service described herein and shall not create or extend in any manner whatsoever, any liability of ST.

ST and the ST logo are trademarks or registered trademarks of ST in various countries.

Information in this document supersedes and replaces all information previously supplied.

The ST logo is a registered trademark of STMicroelectronics. All other names are the property of their respective owners.

© 2007 STMicroelectronics - All rights reserved

STMicroelectronics group of companies

Australia - Belgium - Brazil - Canada - China - Czech Republic - Finland - France - Germany - Hong Kong - India - Israel - Italy - Japan - Malaysia - Malta - Morocco - Singapore - Spain - Sweden - Switzerland - United Kingdom - United States of America

[www.st.com](http://www.st.com)