

## Features

- Input Voltage Range: 36V to 75V
- 20W Rated
- 82% Efficiency
- 1500 VDC Isolation
- Low Profile (8.5 mm)
- Small Footprint: 1.52in x 1.73in
- Remote On/Off
- Short Circuit Protection
- Over Temperature Shutdown
- Under-Voltage Lockout
- UL1950 Recognized
- CSA 22.2 950 Certified
- EN60950 Approved
- 4x10<sup>6</sup> Hrs MTBF

## Description

The PT4120 power modules are a series of isolated DC/DC converters housed a low-profile package. Rated for 20 watts or 5A, the series includes standard output voltages ranging from as low as 1.5VDC to 15VDC. The output may be adjusted  $\pm 10\%$  of nominal. These converters are ideal for Telecom, Industrial, Computer, and other distributed power applications that require input-to-output isolation.

Using multiple PT4120 modules, system designers can implement a complete custom power supply solution. The flexibility of full isolation also allows the input or output to be configured for negative voltage operation.

The PT4120 series requires no additional components for proper operation.

## Ordering Information

PT4121□	=	3.3V/5A	(16.5W)
PT4122□	=	5.0V/4A	
PT4123□	=	12.0V/1.6A	
PT4124□	=	15.0V/1.3A	
PT4125□	=	5.2V/3.8A	
PT4126□	=	1.5V/5A	(7.5W)
PT4127□	=	1.8V/5A	(9W)
PT4128□	=	2.5V/5A	(12.5W)
PT4129□	=	1.65V/5A	(8.25W)

## Pin-Out Information

Pin	Function
1	Remote On/Off †
2	-V <sub>IN</sub>
3	+V <sub>IN</sub>
4	-V <sub>OUT</sub>
5	+V <sub>OUT</sub>
6	V <sub>OUT</sub> Adjust †

† For further information, see application notes.

## PT Series Suffix (PT1234x)

Case/Pin Configuration	Order Suffix	Package Code *
Horizontal	<b>A</b>	(EGD)
SMD	<b>C</b>	(EGE)

\* Previously known as package style 710.

(Reference the applicable package code drawing for the dimensions and PC board layout)

## Standard Application

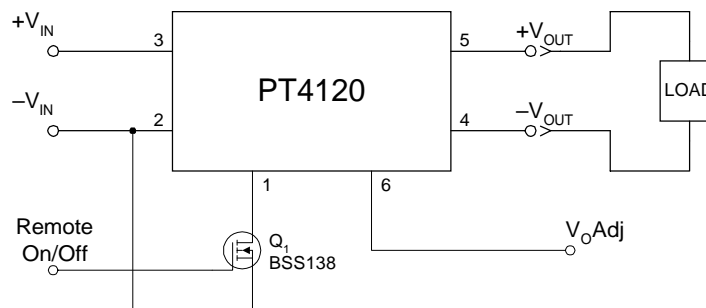

# PT4120 Series

## 20-W 48-V Input Isolated DC/DC Converter

### Specifications (Unless otherwise stated, $T_a = 25^\circ\text{C}$ , $V_{in} = 48\text{V}$ , $C_{out} = 0\mu\text{F}$ , and $I_o = I_{o,max}$ )

Characteristic	Symbol	Conditions	PT4120 SERIES			Units	
			Min	Typ	Max		
Output Current	$I_o$	Over $V_{in}$ range	$V_o = 15\text{V}$	0.1 <sup>(1)</sup>	—	1.3	A
			$V_o = 12\text{V}$	0.1 <sup>(1)</sup>	—	1.6	
			$V_o = 5.0\text{V}$	0.1 <sup>(1)</sup>	—	4.0	
			$V_o \leq 3.3\text{V}$	0.1 <sup>(1)</sup>	—	5.0	
Input Voltage Range	$V_{in}$	Over $I_o$ Range	36.0	48.0	75.0	VDC	
Set Point Voltage Tolerance	$V_o\text{tol}$		$V_o \geq 5.0\text{V}$	—	$\pm 1$	$\pm 1.5$	$\%V_o$
			$V_o \leq 3.3\text{V}$	—	—	$\pm 50$	mV
Temperature Variation	$\text{Reg}_{temp}$	$-40^\circ \leq T_a \leq +85^\circ\text{C}$	—	$\pm 0.5$	—	$\%V_o$	
Line Regulation	$\text{Reg}_{line}$	Over $V_{in}$ range	$V_o \geq 5.0\text{V}$	—	$\pm 0.2$	$\pm 1.0$	$\%V_o$
			$V_o \leq 3.3\text{V}$	—	$\pm 7$	$\pm 33$	mV
Load Regulation	$\text{Reg}_{load}$	Over $I_o$ range	$V_o \geq 5.0\text{V}$	—	$\pm 0.4$	$\pm 1.0$	$\%V_o$
			$V_o \leq 3.3\text{V}$	—	$\pm 13$	$\pm 33$	mV
Total Output Voltage Variation	$\Delta V_{o,tot}$	Includes set-point, line load, $-40^\circ \leq T_a \leq +85^\circ\text{C}$	$V_o \geq 5.0\text{V}$	—	$\pm 2$	—	$\%V_o$
			$V_o \leq 3.3\text{V}$	—	$\pm 67$	—	mV
Efficiency	$\eta$		$V_o = 15\text{V}$	—	86	—	%
			$V_o = 12\text{V}$	—	83	—	
			$V_o = 5.0\text{V}$	—	82	—	
			$V_o = 3.3\text{V}$	—	78	—	
			$V_o = 1.8\text{V}$	—	67	—	
$V_o$ Ripple (pk-pk)	$V_r$	20MHz bandwidth	$V_o \geq 5.0\text{V}$	—	0.5	—	$\%V_o$
			$V_o \leq 3.3\text{V}$	—	15	—	mV <sub>pp</sub>
Transient Response	$t_{tr}$	0.1A/ $\mu\text{s}$ , load step 50% to 100% $I_{o,max}$	—	100	—	$\mu\text{s}$	
	$\Delta V_{tr}$	$V_o$ over/undershoot	$V_o \geq 5.0\text{V}$	—	$\pm 3.0$	—	$\%V_o$
			$V_o \leq 3.3\text{V}$	—	$\pm 150$	—	mV
Short Circuit Current	$I_{sc}$		—	$2 \times I_{o,max}$	—	A	
Switching Frequency	$f_s$	Over $V_{in}$ range	$V_o \geq 12.0\text{V}$	600	650	700	kHz
			$V_o \leq 5.2\text{V}$	800	850	900	
Under-Voltage Lockout	UVLO		—	31	—	V	
Remote On/Off (Pin 1)		Referenced to $-V_{in}$ (pin 2)					
Input High Voltage	$V_{IH}$		2.5	—	7.0 <sup>(2)</sup>	V	
Input Low Voltage	$V_{IL}$		-0.2	—	+0.8		
Input Low Current	$I_{IL}$		—	-10	—	$\mu\text{A}$	
Standby Input Current	$I_{in, standby}$	pins 1 & 2 connected	—	7	50	mA	
Internal Input Capacitance	$C_{in}$		—	0.5	—	$\mu\text{F}$	
External Output Capacitance	$C_{out}$	Between $+V_o$ and $-V_o$	0	—	200	$\mu\text{F}$	
Isolation Voltage		Input to output	1500	—	—	V	
Capacitance			—	1100	—	pF	
Resistance			10	—	—	$\text{M}\Omega$	
Operating Temperature Range	$T_a$	Over $V_{in}$ range	-40	—	+85 <sup>(3)</sup>	$^\circ\text{C}$	
Storage Temperature	$T_s$	—	-40	—	+125	$^\circ\text{C}$	
Reliability	MTBF	Per Bellcore TR-332 50% stress, $T_a = 40^\circ\text{C}$ , ground benign	4.0	—	—	$10^6$ Hrs	
Mechanical Shock	—	Per Mil-Std-883D, method 2002.3, 1mS, half-sine, mounted to a fixture	—	500	—	G's	
Mechanical Vibration	—	Per Mil-Std-883D, method 2007.2, 20-2000Hz, soldered in a PC board	—	15	—	G's	
Weight	—	—	—	23	—	grams	
Flammability	—	Materials meet UL 94V-0	—	—	—	—	

**Notes:** (1) The DC/DC converter will operate at no load with reduced specifications.

(2) The Remote On/Off (pin 1) has an internal pull-up, and if it is left open circuit the PT4120 will operate when input power is applied. Refer to the application notes for interface considerations.

(3) See Safe Operating Area curves or contact the factory for the appropriate derating.

**PT4121, 3.3 VDC** (See Note A)

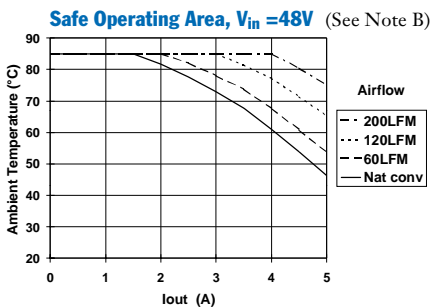
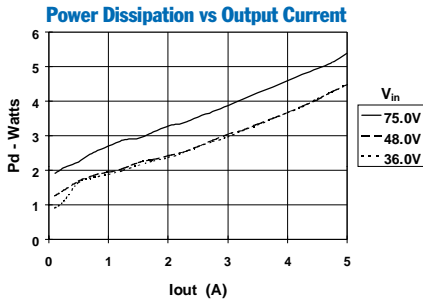
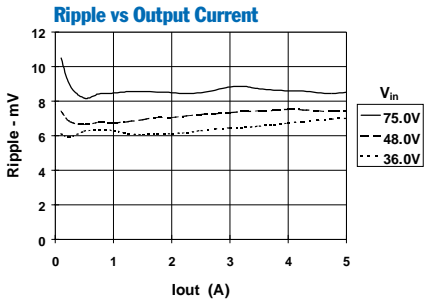
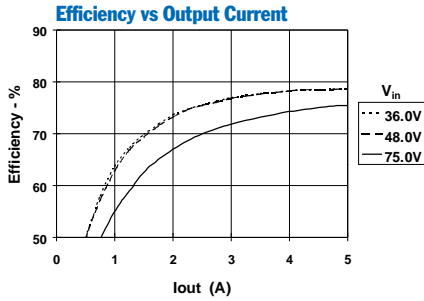

**PT4122, 5.0 VDC** (See Note A)

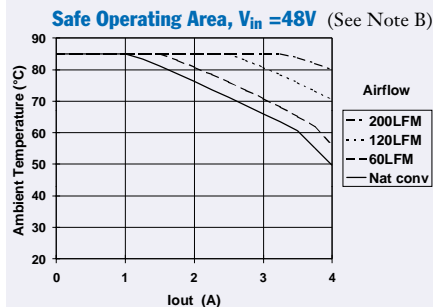
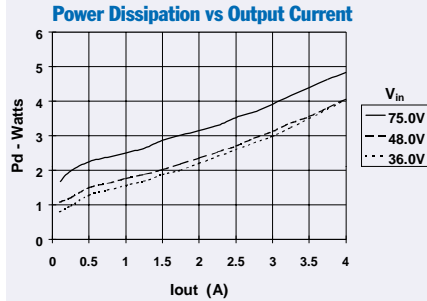
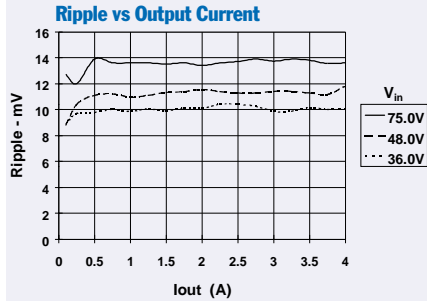
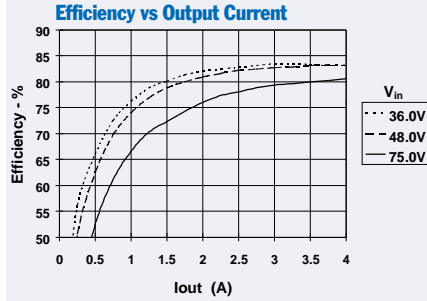

**PT4123, 12.0 VDC** (See Note A)

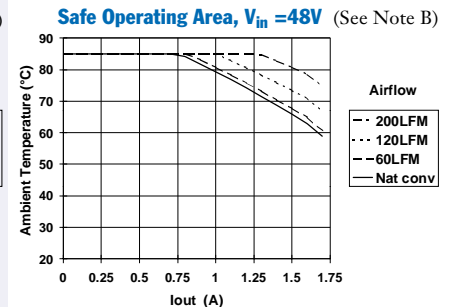
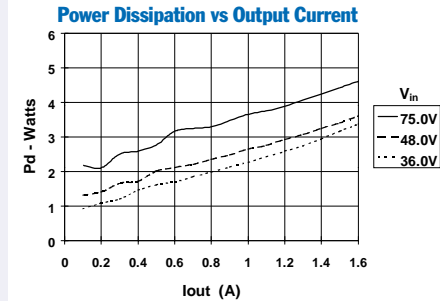
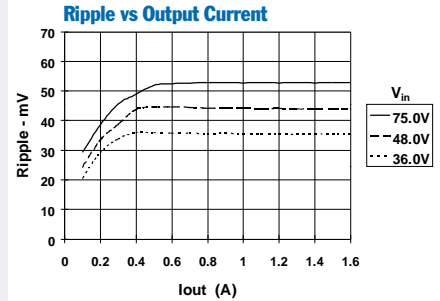
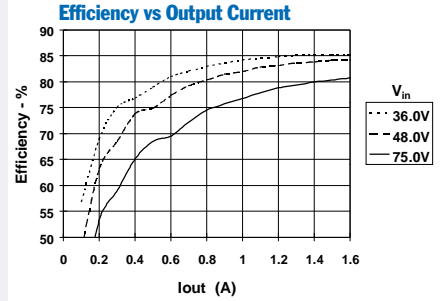

**Note A:** Characteristic data has been developed from actual products tested at 25°C. This data is considered typical data for the Converter.  
**Note B:** SOA curves represent the conditions at which internal components are at or below the manufacturer's maximum operating temperatures

## Using the Remote On/Off Function on the PT4120/PT4140 Series of Isolated DC/DC Converters

For applications requiring output voltage on/off control, the PT4120/4140 series of DC/DC converters incorporate a remote on/off function. This function may be used in applications that require battery conservation, power-up/shutdown sequencing, and/or to co-ordinate the power-up of the regulator for active in-rush current control. (See the related application note, AN21).

This function is provided by the *Remote On/Off* control, pin1. If pin 1 is left open-circuit, the converter provides a regulated output whenever a valid source voltage<sup>3</sup> is applied between +V<sub>in</sub>(pin 3), and -V<sub>in</sub> (pin 2). Applying a low-level ground signal<sup>1</sup> to pin 1 will disable the regulator output<sup>5</sup>.

Table 1 provides details of the threshold requirements for the *Remote On/Off* pin. Figure 1 shows how a discrete MOSFET (Q<sub>1</sub>)<sup>4</sup>, may be referenced to the negative input voltage rail and used with this control input.

**Table 1 Inhibit Control Thresholds**

Parameter	min	max
Enable (V <sub>IH</sub> )	2.5V	(Open Circuit) <sup>2,4</sup>
Disable (V <sub>IL</sub> )	-0.3V	0.8V

**Notes:**

1. The on/off control uses -V<sub>in</sub> (pin 2), the primary side of the converter as its ground reference. All voltages specified are with respect to -V<sub>in</sub>.
2. The on/off control internal circuitry is a high impedance 10µA current source. The open-circuit voltage may be as high as 8.3Vdc.
3. The PT4120/40 series incorporates an “Under Voltage Lockout” (UVLO) function. This function automatically inhibits the converter output until there is sufficient input voltage for the converter to produce a regulated output. Table 2 gives the applicable UVLO thresholds.

**Table 2 UVLO Thresholds**

Series	UVLO Threshold	V <sub>in</sub> Range
PT4120	31V Typical	36 – 75V
PT4140	15V Typical	18 – 40V

4. The *Remote On/Off* input of the PT4120/40 series regulators must be controlled with an open-collector (or open-drain) discrete transistor or MOSFET. *Do not* use a pull-up resistor.
5. When the converter output is disabled, the current drawn from the input supply is typically reduced to 8mA (16mA maximum).

6. Keep the on/off transition to less than 1ms. This prevents erratic operation of the ISR, whereby the output voltage may drift un-regulated between 0V and the rated output during power-up.

**Figure 1**

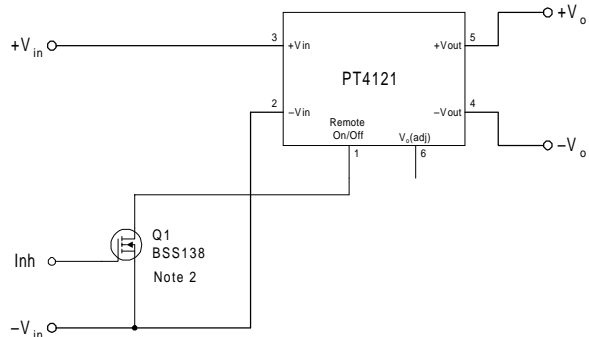

**Turn-On Time:** The converter typically produces a fully regulated output voltage within 50ms after the application of power, or the removal of the low voltage signal<sup>6</sup> from the *Remote On/Off* pin. The actual turn-on time will vary with the input voltage, output load, and the total amount of capacitance connected to the output. Using the circuit of Figure 1, Figure 2 shows the output voltage and input current waveforms of a PT4121 after Q<sub>1</sub> is turned off. The turn off of Q<sub>1</sub> corresponds to the drop in Q<sub>1</sub> V<sub>gs</sub> voltage. The waveforms were measured with a 48Vdc input voltage, and 2.75-A resistive load.

**Figure 2**

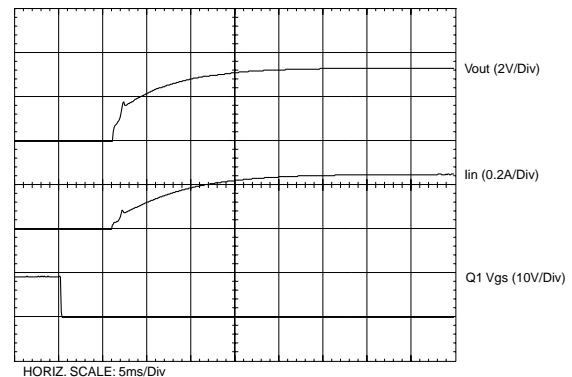

## Adjusting the Output Voltage of the PT4120/PT4140 Series of Isolated DC/DC Converters

The factory pre-set output voltage of Power Trends' PT4120 and PT4140 series of isolated DC/DC converters may be adjusted within  $\pm 10\%$  of nominal. Adjustment is made from the secondary side of the regulator<sup>1</sup> with a single external resistor. For the input voltage range specified in the data sheet Table 1 gives the allowable adjustment range for each model, as  $V_o$  (min) and  $V_o$  (max).

**Adjust Up:** An increase in the output voltage is obtained by adding a resistor,  $R_2$  between pin 6 ( $V_o$  adjust), and pin 4 ( $-V_{out}$ ).

**Adjust Down:** Add a resistor ( $R_1$ ), between pin 6 ( $V_o$  adjust) and pin 5 ( $+V_{out}$ ).

Refer to Figure 1 and Table 2 for both the placement and value of the required resistor, ( $R_1$ ) or  $R_2$ .

### Notes:

- The PT4120 and PT4140 series of DC/DC converters incorporate isolation between the  $V_{in}$  and  $V_o$  terminals. Adjustment of the output voltage is made to the regulation circuit on the secondary or output side of the converter.
- The maximum rated output power for this series is 20W. An increase in the output voltage may therefore require a corresponding reduction in the maximum output current (see Table 1). The revised maximum output current must be determined as follows:-

$$I_o(\max) = \frac{20}{V_a} \text{ A, or } 5\text{A, whichever is less.}$$

Where  $V_a$  is the adjusted output voltage.

- Use only a single 1% resistor in either the ( $R_1$ ) or  $R_2$  location. Place the resistor as close to the ISR as possible.

- Never connect capacitors to  $V_o$  adjust. Any capacitance added to the  $V_o$  adjust control pin will affect the stability of the ISR.

The values of ( $R_1$ ) [adjust down], and  $R_2$  [adjust up], can also be calculated using the following formulas.

$$(R_1) = \frac{K_o (V_a - V_r)}{V_r (V_o - V_a)} - R_s \quad \text{k}\Omega$$

$$R_2 = \frac{K_o}{(V_a - V_o)} - R_s \quad \text{k}\Omega$$

Where  $V_o$  = Original output voltage  
 $V_a$  = Adjusted output voltage  
 $V_r$  = Reference voltage (Table 1)  
 $K_o$  = Multiplier constant (Table 1)  
 $R_s$  = Internal series resistance (Table 1)

Figure 1

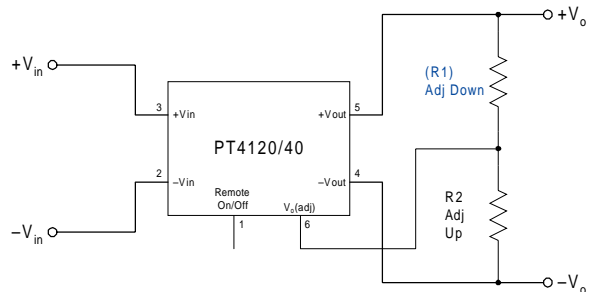

Table 1

### DC/DC CONVERTER ADJUSTMENT RANGE AND FORMULA PARAMETERS

Series Pt #	PT4126	PT4129	PT4127	PT4128	PT4121	PT4122	PT4125	PT4123	PT4124
48V Bus	PT4126	PT4129	PT4127	PT4128	PT4121	PT4122	PT4125	PT4123	PT4124
24V Bus	PT4146	PT4147	PT4148	PT4141	PT4142	PT4143	PT4144		
Max Current <sup>2</sup>	5A	5A	5A	5A	5A	4A	3.8A	1.6A	1.3A
$V_o$ (nom)	1.5	1.65	1.8	2.5	3.3	5.0	5.2V	12.0	15.0
$V_a$ (min)	1.35	1.49	1.62	2.25	2.95	4.5	4.75	10.8	13.5
$V_a$ (max)	1.65	1.81	1.98	2.75	3.65	5.5	5.75	13.2	16.5
$V_r$	1.225	1.225	1.225	1.225	1.225	2.5	2.5	2.5	2.5
$K_o$ (V·k $\Omega$ )	67.07	63.9	69.7	64.2	69.3	125.2	134.7	139.8	137.6
$R_s$ (k $\Omega$ )	43.2	66.5	110.0	187.0	187.0	187.0	243.0	110.0	90.9

PT4120/4140 Series

**Table 2**

**DC/DC CONVERTER SERIES ADJUSTMENT RESISTOR VALUES**

Series Pt #	48V Bus				24V Bus		12.0Vdc		15.0Vdc	
	PT4126	PT4127	PT4128	PT4121	PT4122	PT4142	PT4123	PT4143	PT4124	PT4144
V <sub>o</sub> (nom)	1.5Vdc	1.8Vdc	2.5Vdc	3.3Vdc	5.0Vdc		12.0Vdc		15.0Vdc	
V <sub>a</sub> (req'd)	V <sub>a</sub> (req'd)				V <sub>a</sub> (req'd)		V <sub>a</sub> (req'd)		V <sub>a</sub> (req'd)	
1.35	(2.8)kΩ				4.5	(12.6)kΩ	10.8	(276.0)kΩ		
1.4	(53.2)kΩ				4.55	(40.3)kΩ	11.0	(365.0)kΩ		
1.45	(204.0)kΩ				4.6	(75.0)kΩ	11.2	(497.0)kΩ		
1.5					4.65	(120.0)kΩ	11.4	(719.0)kΩ		
1.55	1.3MΩ				4.7	(179.0)kΩ	11.6	(1.16)MΩ		
1.6	627.0kΩ				4.75	(262.0)kΩ	11.8			
1.65	404.0kΩ	(51.7)kΩ			4.8	(387.0)kΩ	12.0			
1.7		(161.0)kΩ			4.85	(595.0)kΩ	12.2	588.0kΩ		
1.75		(489.0)kΩ			4.9	(1.01)MΩ	12.4	239.0kΩ		
1.8					4.95		12.6	123.0kΩ		
1.85		1.28MΩ			5.0		12.8	64.6kΩ		
1.9		587.0kΩ			5.05		13.0	29.7kΩ		
1.95		355.0kΩ			5.1	1.06MΩ	13.2	6.4kΩ		
2.25			(26.5)kΩ		5.15	645.0kΩ	13.5		(312.0)kΩ	
2.3			(92.9)kΩ		5.2	437.0kΩ	13.6		(345.0)kΩ	
2.35			(203.0)kΩ		5.25	312.0kΩ	13.8		(427.0)kΩ	
2.4			(425.0)kΩ		5.3	229.0kΩ	14.0		(542.0)kΩ	
2.45			(1.09)MΩ		5.35	169.0kΩ	14.2		(713.0)kΩ	
2.5					5.4	125.0kΩ	14.4		(1.0)MΩ	
2.55			1.09MΩ		5.45	90.2kΩ	14.6		(1.57)MΩ	
2.6			450.0kΩ		5.5	62.4kΩ	14.8			
2.65			237.0kΩ				15.0			
2.7			131.0kΩ				15.2		597.0kΩ	
2.75			67.7kΩ				15.4		253.0kΩ	
2.95				(90.7)kΩ			15.6		138.0kΩ	
3.0				(146.0)kΩ			15.8		81.0kΩ	
3.05				(224.0)kΩ			16.0		46.6kΩ	
3.1				(341.0)kΩ			16.5		0.8kΩ	
3.15				(536.0)kΩ						
3.2				(926.0)kΩ						
3.25				(2.09)MΩ						
3.3										
3.35				1.19MΩ						
3.4				502.0kΩ						
3.45				272.0kΩ						
3.5				158.0kΩ						
3.55				88.7kΩ						
3.6				42.7kΩ						
3.65				9.9kΩ						

R<sub>1</sub> = (Blue)      R<sub>2</sub> = Black

**PACKAGING INFORMATION**

Orderable Device	Status (1)	Package Type	Package Drawing	Pins	Package Qty	Eco Plan (2)	Lead/Ball Finish	MSL Peak Temp (3)	Op Temp (°C)	Top-Side Markings (4)	Samples
PT4121C	LIFEBUY	DIP MODULE	EGE	6	16	Pb-Free (RoHS)	Call TI	Level-1-215C-UNLIM	-40 to 85		
PT4122A	LIFEBUY	DIP MODULE	EGD	6	16	Pb-Free (RoHS)	Call TI	N / A for Pkg Type	-40 to 85		
PT4122C	LIFEBUY	DIP MODULE	EGE	6	16	Pb-Free (RoHS)	Call TI	Level-1-215C-UNLIM	-40 to 85		
PT4123A	LIFEBUY	DIP MODULE	EGD	6	16	Pb-Free (RoHS)	Call TI	N / A for Pkg Type	-40 to 85		
PT4124A	LIFEBUY	DIP MODULE	EGD	6	16	Pb-Free (RoHS)	Call TI	N / A for Pkg Type	-40 to 85		
PT4124C	LIFEBUY	DIP MODULE	EGE	6	16	Pb-Free (RoHS)	Call TI	Level-1-215C-UNLIM	-40 to 85		
PT4126A	LIFEBUY	DIP MODULE	EGD	6	16	Pb-Free (RoHS)	Call TI	N / A for Pkg Type	-40 to 85		

(1) The marketing status values are defined as follows:

**ACTIVE:** Product device recommended for new designs.

**LIFEBUY:** TI has announced that the device will be discontinued, and a lifetime-buy period is in effect.

**NRND:** Not recommended for new designs. Device is in production to support existing customers, but TI does not recommend using this part in a new design.

**PREVIEW:** Device has been announced but is not in production. Samples may or may not be available.

**OBSOLETE:** TI has discontinued the production of the device.

(2) Eco Plan - The planned eco-friendly classification: Pb-Free (RoHS), Pb-Free (RoHS Exempt), or Green (RoHS & no Sb/Br) - please check <http://www.ti.com/productcontent> for the latest availability information and additional product content details.

**TBD:** The Pb-Free/Green conversion plan has not been defined.

**Pb-Free (RoHS):** TI's terms "Lead-Free" or "Pb-Free" mean semiconductor products that are compatible with the current RoHS requirements for all 6 substances, including the requirement that lead not exceed 0.1% by weight in homogeneous materials. Where designed to be soldered at high temperatures, TI Pb-Free products are suitable for use in specified lead-free processes.

**Pb-Free (RoHS Exempt):** This component has a RoHS exemption for either 1) lead-based flip-chip solder bumps used between the die and package, or 2) lead-based die adhesive used between the die and leadframe. The component is otherwise considered Pb-Free (RoHS compatible) as defined above.

**Green (RoHS & no Sb/Br):** TI defines "Green" to mean Pb-Free (RoHS compatible), and free of Bromine (Br) and Antimony (Sb) based flame retardants (Br or Sb do not exceed 0.1% by weight in homogeneous material)

(3) MSL, Peak Temp. -- The Moisture Sensitivity Level rating according to the JEDEC industry standard classifications, and peak solder temperature.

(4) Multiple Top-Side Markings will be inside parentheses. Only one Top-Side Marking contained in parentheses and separated by a "~" will appear on a device. If a line is indented then it is a continuation of the previous line and the two combined represent the entire Top-Side Marking for that device.

**Important Information and Disclaimer:** The information provided on this page represents TI's knowledge and belief as of the date that it is provided. TI bases its knowledge and belief on information provided by third parties, and makes no representation or warranty as to the accuracy of such information. Efforts are underway to better integrate information from third parties. TI has taken and continues to take reasonable steps to provide representative and accurate information but may not have conducted destructive testing or chemical analysis on incoming materials and chemicals. TI and TI suppliers consider certain information to be proprietary, and thus CAS numbers and other limited information may not be available for release.

In no event shall TI's liability arising out of such information exceed the total purchase price of the TI part(s) at issue in this document sold by TI to Customer on an annual basis.



## IMPORTANT NOTICE

Texas Instruments Incorporated and its subsidiaries (TI) reserve the right to make corrections, enhancements, improvements and other changes to its semiconductor products and services per JESD46, latest issue, and to discontinue any product or service per JESD48, latest issue. Buyers should obtain the latest relevant information before placing orders and should verify that such information is current and complete. All semiconductor products (also referred to herein as "components") are sold subject to TI's terms and conditions of sale supplied at the time of order acknowledgment.

TI warrants performance of its components to the specifications applicable at the time of sale, in accordance with the warranty in TI's terms and conditions of sale of semiconductor products. Testing and other quality control techniques are used to the extent TI deems necessary to support this warranty. Except where mandated by applicable law, testing of all parameters of each component is not necessarily performed.

TI assumes no liability for applications assistance or the design of Buyers' products. Buyers are responsible for their products and applications using TI components. To minimize the risks associated with Buyers' products and applications, Buyers should provide adequate design and operating safeguards.

TI does not warrant or represent that any license, either express or implied, is granted under any patent right, copyright, mask work right, or other intellectual property right relating to any combination, machine, or process in which TI components or services are used. Information published by TI regarding third-party products or services does not constitute a license to use such products or services or a warranty or endorsement thereof. Use of such information may require a license from a third party under the patents or other intellectual property of the third party, or a license from TI under the patents or other intellectual property of TI.

Reproduction of significant portions of TI information in TI data books or data sheets is permissible only if reproduction is without alteration and is accompanied by all associated warranties, conditions, limitations, and notices. TI is not responsible or liable for such altered documentation. Information of third parties may be subject to additional restrictions.

Resale of TI components or services with statements different from or beyond the parameters stated by TI for that component or service voids all express and any implied warranties for the associated TI component or service and is an unfair and deceptive business practice. TI is not responsible or liable for any such statements.

Buyer acknowledges and agrees that it is solely responsible for compliance with all legal, regulatory and safety-related requirements concerning its products, and any use of TI components in its applications, notwithstanding any applications-related information or support that may be provided by TI. Buyer represents and agrees that it has all the necessary expertise to create and implement safeguards which anticipate dangerous consequences of failures, monitor failures and their consequences, lessen the likelihood of failures that might cause harm and take appropriate remedial actions. Buyer will fully indemnify TI and its representatives against any damages arising out of the use of any TI components in safety-critical applications.

In some cases, TI components may be promoted specifically to facilitate safety-related applications. With such components, TI's goal is to help enable customers to design and create their own end-product solutions that meet applicable functional safety standards and requirements. Nonetheless, such components are subject to these terms.

No TI components are authorized for use in FDA Class III (or similar life-critical medical equipment) unless authorized officers of the parties have executed a special agreement specifically governing such use.

Only those TI components which TI has specifically designated as military grade or "enhanced plastic" are designed and intended for use in military/aerospace applications or environments. Buyer acknowledges and agrees that any military or aerospace use of TI components which have **not** been so designated is solely at the Buyer's risk, and that Buyer is solely responsible for compliance with all legal and regulatory requirements in connection with such use.

TI has specifically designated certain components as meeting ISO/TS16949 requirements, mainly for automotive use. In any case of use of non-designated products, TI will not be responsible for any failure to meet ISO/TS16949.

### Products

Audio	<a href="http://www.ti.com/audio">www.ti.com/audio</a>
Amplifiers	<a href="http://amplifier.ti.com">amplifier.ti.com</a>
Data Converters	<a href="http://dataconverter.ti.com">dataconverter.ti.com</a>
DLP® Products	<a href="http://www.dlp.com">www.dlp.com</a>
DSP	<a href="http://dsp.ti.com">dsp.ti.com</a>
Clocks and Timers	<a href="http://www.ti.com/clocks">www.ti.com/clocks</a>
Interface	<a href="http://interface.ti.com">interface.ti.com</a>
Logic	<a href="http://logic.ti.com">logic.ti.com</a>
Power Mgmt	<a href="http://power.ti.com">power.ti.com</a>
Microcontrollers	<a href="http://microcontroller.ti.com">microcontroller.ti.com</a>
RFID	<a href="http://www.ti-rfid.com">www.ti-rfid.com</a>
OMAP Applications Processors	<a href="http://www.ti.com/omap">www.ti.com/omap</a>
Wireless Connectivity	<a href="http://www.ti.com/wirelessconnectivity">www.ti.com/wirelessconnectivity</a>

### Applications

Automotive and Transportation	<a href="http://www.ti.com/automotive">www.ti.com/automotive</a>
Communications and Telecom	<a href="http://www.ti.com/communications">www.ti.com/communications</a>
Computers and Peripherals	<a href="http://www.ti.com/computers">www.ti.com/computers</a>
Consumer Electronics	<a href="http://www.ti.com/consumer-apps">www.ti.com/consumer-apps</a>
Energy and Lighting	<a href="http://www.ti.com/energy">www.ti.com/energy</a>
Industrial	<a href="http://www.ti.com/industrial">www.ti.com/industrial</a>
Medical	<a href="http://www.ti.com/medical">www.ti.com/medical</a>
Security	<a href="http://www.ti.com/security">www.ti.com/security</a>
Space, Avionics and Defense	<a href="http://www.ti.com/space-avionics-defense">www.ti.com/space-avionics-defense</a>
Video and Imaging	<a href="http://www.ti.com/video">www.ti.com/video</a>

### TI E2E Community

[e2e.ti.com](http://e2e.ti.com)