

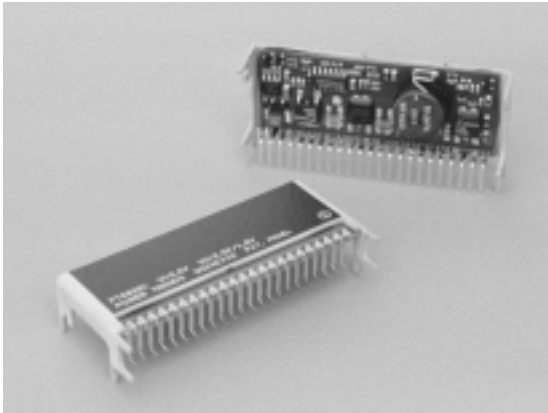

### Features

- Dual Outputs  
(See *Ordering Information*)
- 5V/3.3V Input
- Outputs Adjustable
- Remote Sensing ( $V_{O1}$  &  $V_{O2}$ )
- Standby Function
- Soft-Start
- Internal Sequencing
- Short Circuit Protection
- 23-pin Space-Saving Package
- Solderable Copper Case
- Ideal Power Source for DSPs



### Description

The PT6935 Excalibur™ series of power modules are dual output integrated switching regulators (ISRs) designed to power the latest mixed signal ICs. The dual output provides power for both the digital I/O logic and a DSP core from a single module. Both output voltages are internally sequenced during power-up and power-down to comply with the requirements of the latest DSP chips. Each output is independently adjustable or can be set to at least one alternative bus voltage with a simple pin-strap. The modules are made available in a space-saving solderable case. Features include an output current limit and short-circuit protection.

### Ordering Information

- PT6935□ = +2.5/1.8 Volts
- PT6936□ = +3.3/2.5 Volts
- PT6937□ = +3.3/1.8 Volts
- PT6938□ = +3.3/1.2 Volts
- PT6939□ = +2.5/1.2 Volts

### PT Series Suffix (PT1234x)

Case/Pin Configuration	Order Suffix	Package Code
Vertical	<b>N</b>	(ELF)
Horizontal	<b>A</b>	(ELG)
SMD	<b>C</b>	(ELH)

(Reference the applicable package code drawing for the dimensions and PC layout)

### Pin-Out Information

Pin	Function	Pin	Function
1	$V_{O1}$ Sense	13	$V_{O1}$
2	No Connect	14	$V_{O1}$
3	STBY	15	$V_{O1}$
4	$V_{in}$	16	$V_{O1}$ Adjust*
5	$V_{in}$	17	No Connect
6	$V_{in}$	18	$V_{O2}$
7	GND	19	$V_{O2}$
8	GND	20	$V_{O2}$
9	GND	21	$V_{O2}$
10	GND	22	$V_{O2}$ Sense
11	GND	23	$V_{O2}$ Adjust*
12	$V_{O1}$		

\*  $V_{O1}$  and  $V_{O2}$  can be pin-strapped to another voltage. See application note on output voltage adjustment.

### Standard Application

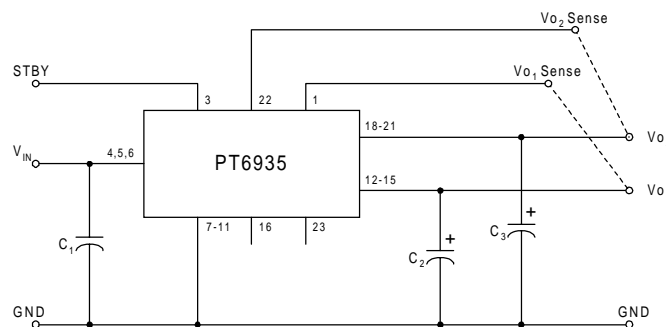

- $C_1$  = Req'd 330 $\mu$ F \* electrolytic
- $C_2$  = Req'd 330 $\mu$ F \* electrolytic
- $C_3$  = Optional 100 $\mu$ F electrolytic

\* 300 $\mu$ F for Oscon® or low ESR tantalum -see notes

## 11-A 5V/3.3V-Input Dual Output Integrated Switching Regulator

General Specifications (Unless otherwise stated,  $T_a = 25^\circ\text{C}$ ,  $V_{in} = 5\text{V}$ )

Characteristic	Symbol	Conditions	PT6935 Series			Units
			Min	Typ	Max	
Short Circuit Current	$I_{sc}$	$Io_1 + Io_2$ combined	—	17	—	A
Switching Frequency	$f_o$	Over $V_{in}$ range	300	350	400	kHz
Standby (Pin 3)		Referenced to GND (pin 7)				
Input High Voltage	$V_{IH}$		—	—	Open <sup>(1)</sup>	V
Input Low Voltage	$V_{IL}$		-0.1	—	+0.4	
Input Low Current	$I_{IL}$		—	-0.5	—	mA
Standby Input Current	$I_{in, standby}$	pin 3 to GND	—	7	25	mA
External Output Capacitance	$C_2$ $C_3$		330 <sup>(2)</sup> 0	—	3,300 <sup>(2)</sup> 330	$\mu\text{F}$
Maximum Operating Temperature Range	$T_a$	Over $V_{in}$ Range	-40 <sup>(3)</sup>	—	+85 <sup>(4)</sup>	$^\circ\text{C}$
Storage Temperature	$T_s$	—	-40	—	+125	$^\circ\text{C}$
Mechanical Shock		Per Mil-STD-883D, Method 2002.3 1 msec, ½ Sine, mounted	—	500	—	G's
Mechanical Vibration		Per Mil-STD-883D, Method 2007.2 20-2000 Hz, Soldered in a PC board	—	15 <sup>(5)</sup>	—	G's
Weight	—	Vertical/Horizontal	—	26	—	grams
Flammability	—	Meets UL 94V-O	—	—	—	—

- Notes:**
- (1) The Standby (pin 3) has an internal pull-up, and if it is left open circuit the module will operate when input power is applied. The open-circuit voltage is less than 15V. Refer to the application notes for interface considerations.
  - (2) A value of 300 $\mu\text{F}$  is sufficient if Oscon® or low ESR tantalum type capacitors are used. The total combined ESR of all output capacitance at 100kHz must be (greater than)  $>12\text{ m}\Omega$ , and (less or equal to)  $\leq 150\text{ m}\Omega$ .
  - (3) For operating temperatures below  $0^\circ\text{C}$ ,  $C_{in}$  and  $C_{out}$  must have stable characteristics. Use either tantalum or Oscon® capacitors.
  - (4) See Safe Operating Area curves for the specific output voltage combination, or contact the factory for the appropriate derating.
  - (5) Only the case pins on through-hole pin configurations (N & A) must be soldered. For more information see the applicable package outline drawing.

**Input/Output Capacitors:** The PT6935 series requires a 330 $\mu\text{F}$  electrolytic capacitor at both the input and output for proper operation (300 $\mu\text{F}$  for Oscon® or low ESR tantalum). In addition, the input capacitance must be rated for a minimum of 1.0Arms ripple current. For transient or dynamic load applications, additional capacitance may be required. Refer to the application notes for more information.

Power-up Sequencing and  $Vo_1/Vo_2$  Loading

## Power-up Sequencing

The PT6935 series of regulators provide two output voltages,  $Vo_1$  and  $Vo_2$ . Each of the output voltage combinations offered by the PT6935 series provides power for both a low-voltage processor core, and the associated digital support circuitry. In addition, each output is internally sequenced during power-up and power-down to comply with the requirements of most DSP and  $\mu\text{P}$  IC's, and their accompanying chipsets. Figure 1 shows the typical waveforms of the output voltages,  $Vo_1$  and  $Vo_2$ , from the instance that either input power is applied or the module is enabled via the Standby pin. Following a delay of about 10 to 15 milli-secs, the voltages at  $Vo_1$  and  $Vo_2$  rise together until  $Vo_2$  reaches its set-point. Then  $Vo_1$  continues to rise until both output voltages have reached full voltage.

Figure 1; PT6935 Series Power-up

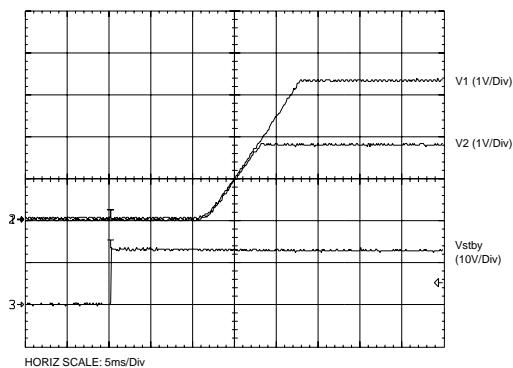
 $Vo_1/Vo_2$  Loading

The output voltages from the PT6935 series regulators are independently regulated. The voltage at  $Vo_1$  is produced by a highly efficient switching regulator. The lower output voltage,  $Vo_2$ , is derived from  $Vo_1$ . The regulation method used for  $Vo_2$  also provides control of this output voltage during power-down.  $Vo_2$  will sink current if the voltage at  $Vo_1$  attempts to fall below it.

The load specifications for each model of the PT6935 series gives both a 'Typical' (Typ) and 'Maximum' (Max) load current for each output. For operation within the product's rating, the load currents at  $Vo_1$  and  $Vo_2$  must comply with the following limits:-

- $Io_2$  must be less than  $Io_2(\text{max})$ .
- The sum-total current from both outputs ( $Io_1 + Io_2$ ) must not exceed  $Io_1(\text{max})$ .

In the case that either  $Vo_1$  or  $Vo_2$  are adjusted to some other value than the default output voltage, the absolute maximum load current for  $Io_2$  must be revised to comply with the following equation.

$$Io_2(\text{max}) = \frac{2.5}{Vo_1 - Vo_2} \text{ Adc}$$

Consult the specification table for each model of the series for the actual numeric values.

11 Amp 5V/3.3V-Input Dual Output Integrated Switching Regulator

**PT6935 Performance Specifications** (Unless otherwise stated,  $T_a = 25^\circ\text{C}$ ,  $V_{in} = 5\text{V}$ ,  $C_1 = 330\mu\text{F}$ ,  $C_2 = 330\mu\text{F}$ ,  $I_{O1} = I_{O1typ}$ , and  $I_{O2} = I_{O2typ}$ )

Characteristic	Symbol	Conditions	PT6935 (2.5V/1.8V)			Units	
			Min	Typ	Max		
Output Current	$I_{O1}$	$T_a = 25^\circ\text{C}$ , natural convection	$V_{O1}$ (2.5V)	0.1 (i)	7 (ii)	9.5 (iii)	A
	$I_{O2}$		$V_{O2}$ (1.8V)	0	2.5 (ii)	3.5 (iii)	
	$I_{O1}$	$T_a = 60^\circ\text{C}$ , 200LFM airflow	$V_{O1}$ (2.5V)	0.1 (i)	7 (ii)	10 (iii)	A
	$I_{O2}$		$V_{O2}$ (1.8V)	0	2.5 (ii)	3.5 (iii)	
Input Voltage Range	$V_{in}$	Over $I_o$ Range		3.1	—	5.5	VDC
Set Point Voltage Tolerance	$V_o$ tol		$V_{O1}$	—	$\pm 12$	$\pm 38$	mV
			$V_{O2}$	—	$\pm 9$	$\pm 27$	
Temperature Variation	$Reg_{temp}$	$-40^\circ > T_a > +85^\circ\text{C}$		—	$\pm 0.5$	—	$\%V_o$
Line Regulation	$Reg_{line}$	Over $V_{in}$ range	$V_{O1}$	—	$\pm 5$	$\pm 10$	mV
			$V_{O2}$	—	$\pm 2$	$\pm 5$	
Load Regulation	$Reg_{load}$	Over $I_o$ range	$V_{O1}$	—	$\pm 5$	$\pm 10$	mV
			$V_{O2}$	—	$\pm 5$	$\pm 10$	
Total Output Voltage Variation	$\Delta V_{otot}$	Includes set-point, line, load, $-40^\circ > T_a > +85^\circ\text{C}$	$V_{O1}$	—	$\pm 34$	—	mV
			$V_{O2}$	—	$\pm 25$	—	
Efficiency	$\eta$			—	79	—	%
$V_o$ Ripple (pk-pk)	$V_r$	20MHz bandwidth	$V_{O1}$	—	3.5	—	mV <sub>pp</sub>
			$V_{O2}$	—	3.5	—	
Transient Response	$t_{tr}$	1A/μs load step, 50% to 100% $I_{Otyp}$		—	60	—	μs
	$\Delta V_{tr}$	$V_o$ over/undershoot	$V_{O1}$	—	$\pm 60$	—	mV
			$V_{O2}$	—	$\pm 60$	—	

**Notes:** (i)  $I_{O1}$  (min) current of 0.1A can be divided between both outputs,  $V_{O1}$  or  $V_{O2}$ . The module will operate at no load with reduced specifications.  
 (ii) The typical current is that which can be drawn simultaneously from both outputs under the stated operating conditions.  
 (iii) The sum of  $I_{O1}$  and  $I_{O2}$  must be less than  $I_{O1max}$ , and  $I_{O2}$  must be less than  $I_{O2max}$ .

**PT6935 Typical Characteristics**

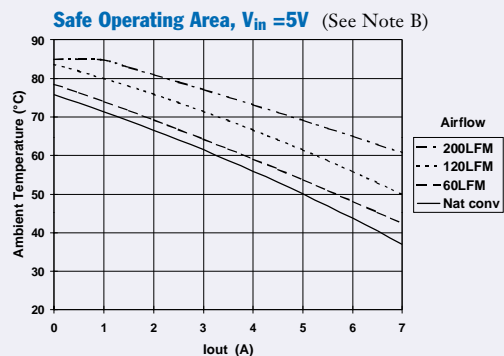
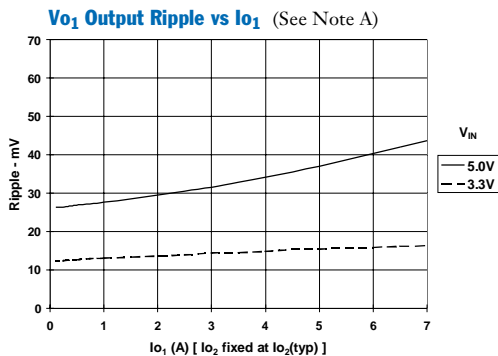
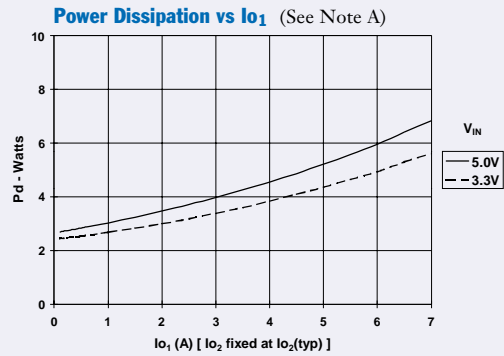
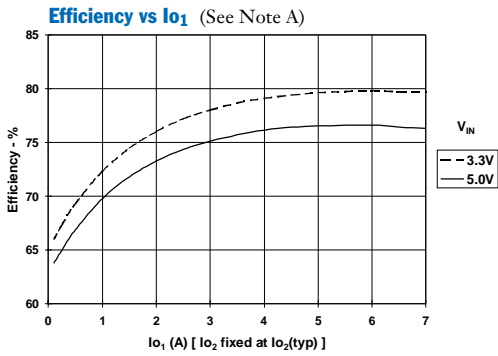

**Note A:** Characteristic data has been developed from actual products tested at  $25^\circ\text{C}$ . This data is considered typical data for the Converter.  
**Note B:** SOA curves represent the conditions at which internal components are at or below the manufacturer's maximum operating temperatures

11 Amp 5V/3.3V-Input Dual Output Integrated Switching Regulator

**PT6936 Performance Specifications** (Unless otherwise stated,  $T_a = 25^\circ\text{C}$ ,  $V_{in} = 5\text{V}$ ,  $C_1 = 330\mu\text{F}$ ,  $C_2 = 330\mu\text{F}$ ,  $I_{O1} = I_{O1typ}$ , and  $I_{O2} = I_{O2typ}$ )

Characteristic	Symbol	Conditions	PT6936 (3.3V/2.5V)			Units	
			Min	Typ	Max		
Output Current	$I_{O1}$	$T_a = 25^\circ\text{C}$ , natural convection	$V_{O1}$ (3.3V)	0.1 (i)	8 (ii)	11 (iii)	A
	$I_{O2}$		$V_{O2}$ (2.5V)	0	3	3	
Input Voltage Range	$V_{in}$	Over $I_O$ Range		4.5	—	5.5	VDC
	Set Point Voltage Tolerance		$V_o$ tol	$V_{O1}$	—	$\pm 16$	
Temperature Variation	$Reg_{temp}$	$-40^\circ > T_a > +85^\circ\text{C}$	$V_{O2}$	—	$\pm 12$	$\pm 38$	
Line Regulation	$Reg_{line}$	Over $V_{in}$ range	$V_{O1}$	—	$\pm 5$	$\pm 10$	mV
Load Regulation	$Reg_{load}$	Over $I_O$ range	$V_{O2}$	—	$\pm 2$	$\pm 5$	
Total Output Voltage Variation	$\Delta V_{otot}$	Includes set-point, line, load, $-40^\circ > T_a > +85^\circ\text{C}$	$V_{O1}$	—	$\pm 5$	$\pm 10$	mV
Efficiency	$\eta$		$V_{O2}$	—	$\pm 5$	$\pm 10$	
$V_o$ Ripple (pk-pk)	$V_r$	20MHz bandwidth		—	81	—	%
Transient Response	$t_{tr}$	1A/μs load step, 50% to 100% $I_{O,typ}$	$V_{O1}$	—	3.5	—	mV <sub>pp</sub>
	$\Delta V_{tr}$	$V_o$ over/undershoot	$V_{O2}$	—	3.5	—	
			$V_{O1}$	—	60	—	μs
			$V_{O2}$	—	$\pm 60$	—	mV

**Notes:** (i)  $I_{O1}$  (min) current of 0.1A can be divided between both outputs,  $V_{O1}$  or  $V_{O2}$ . The module will operate at no load with reduced specifications.  
 (ii) The typical current is that which can be drawn simultaneously from both outputs under the stated operating conditions.  
 (iii) The sum of  $I_{O1}$  and  $I_{O2}$  must be less than  $I_{O1max}$ , and  $I_{O2}$  must be less than  $I_{O2max}$ .

**PT6936 Typical Characteristics**

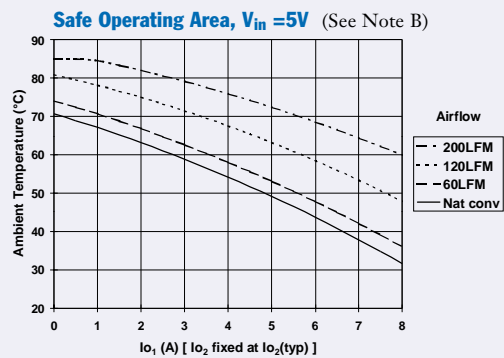
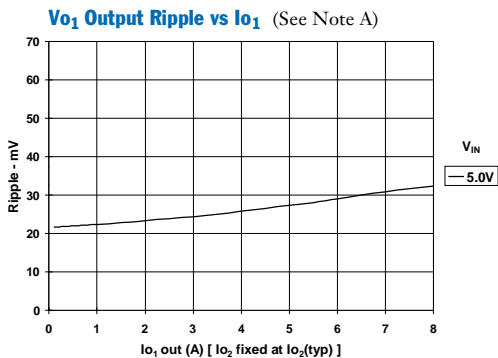
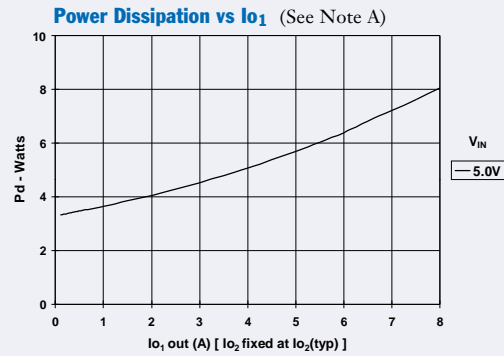
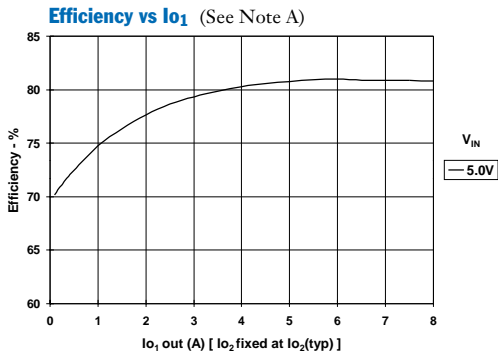

**Note A:** Characteristic data has been developed from actual products tested at  $25^\circ\text{C}$ . This data is considered typical data for the Converter.  
**Note B:** SOA curves represent the conditions at which internal components are at or below the manufacturer's maximum operating temperatures

11 Amp 5V/3.3V-Input Dual Output Integrated Switching Regulator

**PT6937 Performance Specifications** (Unless otherwise stated,  $T_a = 25^\circ\text{C}$ ,  $V_{in} = 5\text{V}$ ,  $C_1 = 330\mu\text{F}$ ,  $C_2 = 330\mu\text{F}$ ,  $I_{O1} = I_{O1typ}$ , and  $I_{O2} = I_{O2typ}$ )

Characteristic	Symbol	Conditions	PT6937 (3.3V/1.8V)			Units	
			Min	Typ	Max		
Output Current	$I_{O1}$	$T_a = 25^\circ\text{C}$ , natural convection	$V_{O1}$ (3.3V)	0.1 (i)	8 (ii)	10 (iii)	A
	$I_{O2}$		$V_{O2}$ (1.8V)	0	2 (ii)	2.25 (iii)	
	$I_{O1}$	$T_a = 60^\circ\text{C}$ , 200LFM airflow	$V_{O1}$ (3.3V)	0.1 (i)	8 (ii)	10 (iii)	A
	$I_{O2}$		$V_{O2}$ (1.8V)	0	2 (ii)	2.25 (iii)	
Input Voltage Range	$V_{in}$	Over $I_o$ Range		4.5	—	5.5	VDC
Set Point Voltage Tolerance	$V_o \text{ tol}$		$V_{O1}$	—	$\pm 16$	$\pm 50$	mV
			$V_{O2}$	—	$\pm 9$	$\pm 27$	
Temperature Variation	$\text{Reg}_{temp}$	$-40^\circ > T_a > +85^\circ\text{C}$		—	$\pm 0.5$	—	$\%V_o$
Line Regulation	$\text{Reg}_{line}$	Over $V_{in}$ range	$V_{O1}$	—	$\pm 5$	$\pm 10$	mV
			$V_{O2}$	—	$\pm 2$	$\pm 5$	
Load Regulation	$\text{Reg}_{load}$	Over $I_o$ range	$V_{O1}$	—	$\pm 5$	$\pm 10$	mV
			$V_{O2}$	—	$\pm 5$	$\pm 10$	
Total Output Voltage Variation	$\Delta V_{otot}$	Includes set-point, line, load, $-40^\circ > T_a > +85^\circ\text{C}$	$V_{O1}$	—	$\pm 29$	—	mV
			$V_{O2}$	—	$\pm 25$	—	
Efficiency	$\eta$			—	81	—	%
$V_o$ Ripple (pk-pk)	$V_r$	20MHz bandwidth	$V_{O1}$	—	3.5	—	mV <sub>pp</sub>
			$V_{O2}$	—	3.5	—	
Transient Response	$t_{tr}$	1A/μs load step, 50% to 100% $I_o$ typ		—	60	—	μs
	$\Delta V_{tr}$	$V_o$ over/undershoot	$V_{O1}$	—	$\pm 60$	—	
			$V_{O2}$	—	$\pm 60$	—	mV

**Notes:** (i)  $I_{O1}$  (min) current of 0.1A can be divided between both outputs,  $V_{O1}$  or  $V_{O2}$ . The module will operate at no load with reduced specifications.  
 (ii) The typical current is that which can be drawn simultaneously from both outputs under the stated operating conditions.  
 (iii) The sum of  $I_{O1}$  and  $I_{O2}$  must be less than  $I_{O1max}$ , and  $I_{O2}$  must be less than  $I_{O2max}$ .

**PT6937 Typical Characteristics**

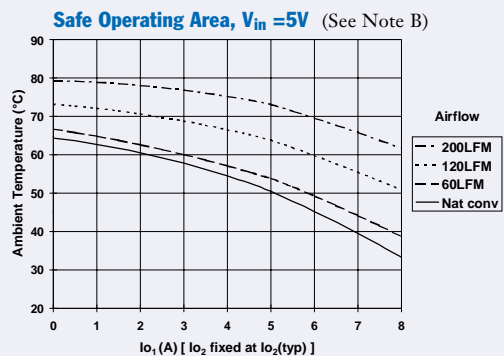
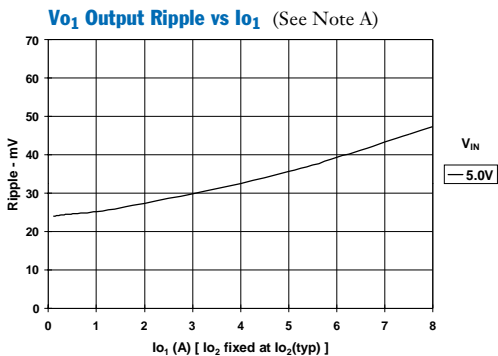
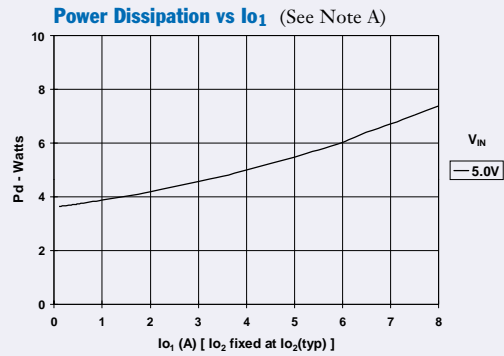
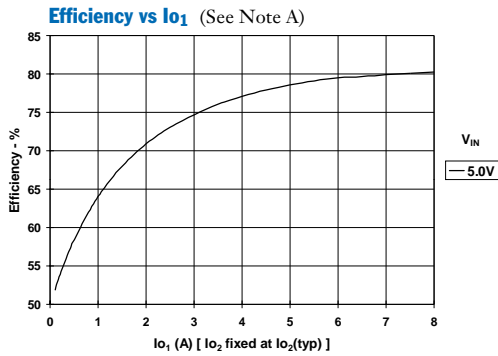

**Note A:** Characteristic data has been developed from actual products tested at  $25^\circ\text{C}$ . This data is considered typical data for the Converter.  
**Note B:** SOA curves represent the conditions at which internal components are at or below the manufacturer's maximum operating temperatures

11 Amp 5V/3.3V-Input Dual Output Integrated Switching Regulator

**PT6938 Performance Specifications** (Unless otherwise stated,  $T_a = 25^\circ\text{C}$ ,  $V_{in} = 5\text{V}$ ,  $C_1 = 330\mu\text{F}$ ,  $C_2 = 330\mu\text{F}$ ,  $I_{O1} = I_{O1typ}$ , and  $I_{O2} = I_{O2typ}$ )

Characteristic	Symbol	Conditions	PT6938 (3.3V/1.2V)			Units	
			Min	Typ	Max		
Output Current	$I_{O1}$	$T_a = 25^\circ\text{C}$ , natural convection	$V_{O1}$ (3.3V)	0.1 (i)	7 (ii)	8.6 (iii)	A
	$I_{O2}$		$V_{O2}$ (1.2V)	0	1.6 (ii)	1.6 (iii)	
	$I_{O1}$	$T_a = 60^\circ\text{C}$ , 200LFM airflow	$V_{O1}$ (3.3V)	0.1 (i)	7 (ii)	8.6 (iii)	A
	$I_{O2}$		$V_{O2}$ (1.2V)	0	1.6 (ii)	1.6 (iii)	
Input Voltage Range	$V_{in}$	Over $I_o$ Range		4.5	—	5.5	VDC
Set Point Voltage Tolerance	$V_o \text{ tol}$		$V_{O1}$	—	$\pm 16$	$\pm 50$	mV
			$V_{O2}$	—	$\pm 6$	$\pm 18$	
Temperature Variation	$\text{Reg}_{temp}$	$-40^\circ > T_a > +85^\circ\text{C}$		—	$\pm 0.5$	—	$\%V_o$
Line Regulation	$\text{Reg}_{line}$	Over $V_{in}$ range	$V_{O1}$	—	$\pm 5$	$\pm 10$	mV
			$V_{O2}$	—	$\pm 2$	$\pm 5$	
Load Regulation	$\text{Reg}_{load}$	Over $I_o$ range	$V_{O1}$	—	$\pm 5$	$\pm 10$	mV
			$V_{O2}$	—	$\pm 5$	$\pm 10$	
Total Output Voltage Variation	$\Delta V_{otot}$	Includes set-point, line, load, $-40^\circ > T_a > +85^\circ\text{C}$	$V_{O1}$	—	$\pm 29$	—	mV
			$V_{O2}$	—	$\pm 19$	—	
Efficiency	$\eta$			—	79	—	%
$V_o$ Ripple (pk-pk)	$V_r$	20MHz bandwidth	$V_{O1}$	—	3.5	—	mV <sub>pp</sub>
			$V_{O2}$	—	3.5	—	
Transient Response	$t_{tr}$	1A/μs load step, 50% to 100% $I_o$ ,typ		—	60	—	μs
	$\Delta V_{tr}$	$V_o$ over/undershoot	$V_{O1}$	—	$\pm 60$	—	mV
			$V_{O2}$	—	$\pm 60$	—	

**Notes:** (i)  $I_{O1}$  (min) current of 0.1A can be divided between both outputs,  $V_{O1}$  or  $V_{O2}$ . The module will operate at no load with reduced specifications.  
 (ii) The typical current is that which can be drawn simultaneously from both outputs under the stated operating conditions.  
 (iii) The sum of  $I_{O1}$  and  $I_{O2}$  must be less than  $I_{O1max}$ , and  $I_{O2}$  must be less than  $I_{O2max}$ .

**PT6938 Typical Characteristics**

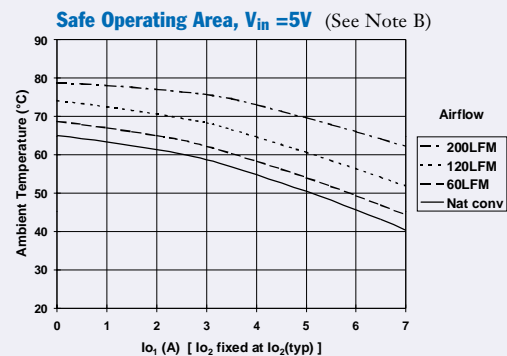
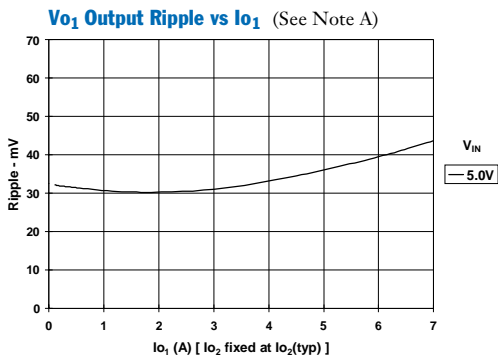
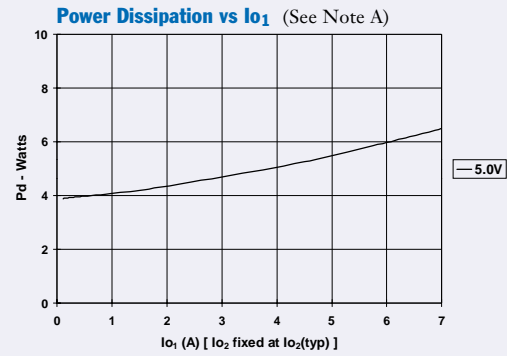
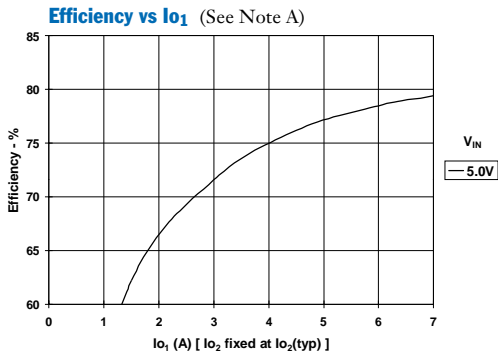

**Note A:** Characteristic data has been developed from actual products tested at  $25^\circ\text{C}$ . This data is considered typical data for the Converter.

**Note B:** SOA curves represent the conditions at which internal components are at or below the manufacturer's maximum operating temperatures

11 Amp 5V/3.3V-Input Dual Output Integrated Switching Regulator

**PT6939 Performance Specifications** (Unless otherwise stated,  $T_a = 25^\circ\text{C}$ ,  $V_{in} = 5\text{V}$ ,  $C_1 = 330\mu\text{F}$ ,  $C_2 = 330\mu\text{F}$ ,  $I_{O1} = I_{O1\text{typ}}$ , and  $I_{O2} = I_{O2\text{typ}}$ )

Characteristic	Symbol	Conditions	PT6939 (2.5V/1.2V)			Units	
			Min	Typ	Max		
Output Current	$I_{O1}$	$T_a = 25^\circ\text{C}$ , natural convection	$V_{O1}$ (2.5V)	0.1 (i)	7 (ii)	9 (iii)	A
	$I_{O2}$		$V_{O2}$ (1.2V)	0	2 (ii)	2.2 (iii)	
	$I_{O1}$	$T_a = 60^\circ\text{C}$ , 200LFM airflow	$V_{O1}$ (2.5V)	0.1 (i)	7 (ii)	9 (iii)	A
	$I_{O2}$		$V_{O2}$ (1.2V)	0	2 (ii)	2.2 (iii)	
Input Voltage Range	$V_{in}$	Over $I_o$ Range		3.1	—	5.5	VDC
Set Point Voltage Tolerance	$V_o \text{ tol}$		$V_{O1}$	—	$\pm 12$	$\pm 38$	mV
			$V_{O2}$	—	$\pm 6$	$\pm 18$	
Temperature Variation	$\text{Reg}_{\text{temp}}$	$-40^\circ > T_a > +85^\circ\text{C}$		—	$\pm 0.5$	—	$\%V_o$
Line Regulation	$\text{Reg}_{\text{line}}$	Over $V_{in}$ range	$V_{O1}$	—	$\pm 5$	$\pm 10$	mV
			$V_{O2}$	—	$\pm 2$	$\pm 5$	
Load Regulation	$\text{Reg}_{\text{load}}$	Over $I_o$ range	$V_{O1}$	—	$\pm 5$	$\pm 10$	mV
			$V_{O2}$	—	$\pm 5$	$\pm 10$	
Total Output Voltage Variation	$\Delta V_{o\text{tot}}$	Includes set-point, line, load, $-40^\circ > T_a > +85^\circ\text{C}$	$V_{O1}$	—	$\pm 34$	—	mV
			$V_{O2}$	—	$\pm 19$	—	
Efficiency	$\eta$			—	75	—	%
$V_o$ Ripple (pk-pk)	$V_r$	20MHz bandwidth	$V_{O1}$	—	3.5	—	mV <sub>pp</sub>
			$V_{O2}$	—	3.5	—	
Transient Response	$t_{tr}$	1A/μs load step, 50% to 100% $I_o\text{typ}$		—	60	—	μs
	$\Delta V_{tr}$	$V_o$ over/undershoot	$V_{O1}$	—	$\pm 60$	—	
			$V_{O2}$	—	$\pm 60$	—	mV

**Notes:** (i)  $I_{O1}$  (min) current of 0.1A can be divided between both outputs,  $V_{O1}$  or  $V_{O2}$ . The module will operate at no load with reduced specifications.  
 (ii) The typical current is that which can be drawn simultaneously from both outputs under the stated operating conditions.  
 (iii) The sum of  $I_{O1}$  and  $I_{O2}$  must be less than  $I_{O1\text{max}}$ , and  $I_{O2}$  must be less than  $I_{O2\text{max}}$ .

**PT6939 Typical Characteristics**

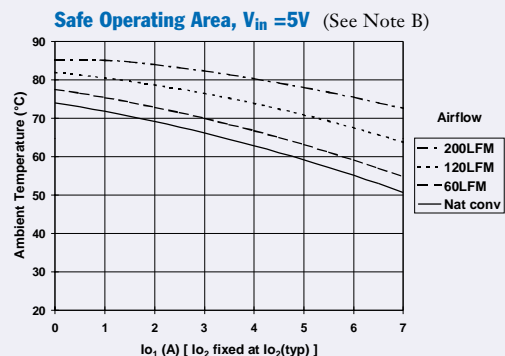
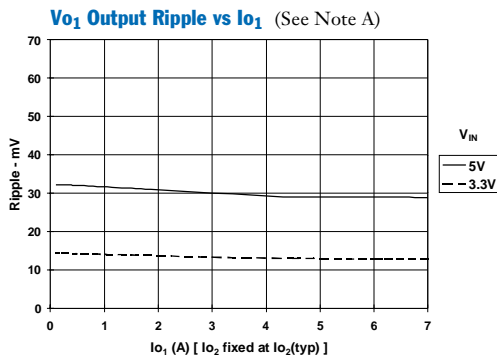
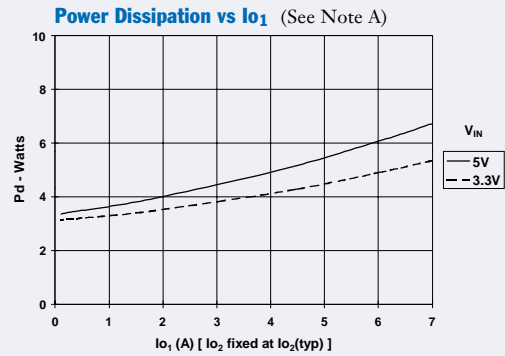
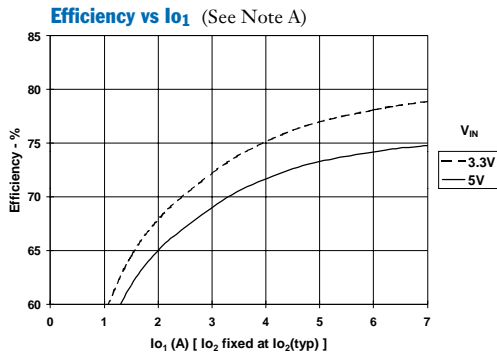

**Note A:** Characteristic data has been developed from actual products tested at  $25^\circ\text{C}$ . This data is considered typical data for the Converter.  
**Note B:** SOA curves represent the conditions at which internal components are at or below the manufacturer's maximum operating temperatures

## Capacitor Recommendations for the Dual-Output PT6935 Regulator Series

### Input Capacitors:

The recommended input capacitance is determined by 1.0 ampere minimum ripple current rating and 330µF minimum capacitance (300µF for Oscon® or low ESR tantalum). Ripple current and <100mΩ equivalent series resistance (ESR) values are the major considerations, along with temperature, when designing with different types of capacitors. Tantalum capacitors have a recommended minimum voltage rating of 2 × the maximum DC voltage + AC ripple. This is necessary to insure reliability for input voltage bus applications

### Output Capacitors: C<sub>2</sub>(Required), C<sub>3</sub>(Optional)

The ESR of the required capacitor (C<sub>2</sub>) must not be greater than 150mΩ. Electrolytic capacitors have poor ripple performance at frequencies greater than 400kHz but excellent low frequency transient response. Above the ripple frequency, ceramic capacitors are necessary to improve the transient response and reduce any high frequency noise components apparent during higher current excursions. Preferred low ESR type capacitor part numbers are identified in Table 1. The optional 100µF capacitor (C<sub>3</sub>) for V<sub>2out</sub> can have an ESR of up to 200mΩ for optimum performance and ripple reduction. (Note: Vendor part numbers for the optional capacitor, C<sub>3</sub>, are not identified in the table. Use the same series selected for C<sub>2</sub>)

### Tantalum Capacitors

Tantalum type capacitors can be used for the output but only the AVX TPS series, Sprague 593D/594/595 series or Kemet T495/T510 series. These capacitors are recommended over many other tantalum types due to their higher rated surge, power dissipation, and ripple current capability. As a caution the TAJ series by AVX is not recommended. This series has considerably higher ESR, reduced power dissipation, and lower ripple current capability. The TAJ series is less reliable than the AVX TPS series when determining power dissipation capability. Tantalum or Oscon® types are recommended for applications where ambient temperatures fall below 0°C.

### Capacitor Table

Table 1 identifies the characteristics of capacitors from a number of vendors with acceptable ESR and ripple current (rms) ratings. The number of capacitors required at both the input and output buses is identified for each capacitor type.

*This is not an extensive capacitor list. Capacitors from other vendors are available with comparable specifications. Those listed are for guidance. The RMS ripple current rating and ESR (Equivalent Series Resistance at 100kHz) are critical parameters necessary to insure both optimum regulator performance and long capacitor life.*

Table 1: Input/Output Capacitors

Capacitor Vendor/ Component Series	Capacitor Characteristics					Quantity		Vendor Number
	Working Voltage	Value(µF)	(ESR) Equivalent Series Resistance	85°C Maximum Ripple Current(Irms)	Physical Size(mm)	Input Bus	Output Bus	
Panasonic FC	25V	560µF	0.0065Ω	1205mA	12.5x15	1	1	EEUFC1E561S
	35V	390µF	0.065Ω	1205mA	12.5x15	2	1	EEUFC1V391S
	35V	330µF	0.117Ω	555mA	8x11.5	N/R	1	EEUFC1C331
United Chemi-Con LXV/FS/LXZ	16V	330µF	0.120Ω	555mA	8x12	N/R	1	LXZ16VB331M8X12LL
	35V	470µF	0.052Ω	1220mA	10x20	1	1	LXZ35VB471M10X20LL
	10V	330µF	0.025Ω	3500mA	10x10.5	1	1	10FS330M
	20V	150µF	0.030+2 Ω	3200mA	10x10.5	2	2	20FS150M
Nichicon PL/ PM	35V	560µF	0.048Ω	1360mA	16x15	1	1	UPL1V561MHH6
	35V	330µF	0.065+2 Ω	1020mA	12.5x15	1	1	UPL1V331MHH6
	50V	470µF	0.046Ω	1470mA	18x15	1	1	UPM1H4711MHH6
Panasonic FC (Surface Mtg)	10V	1000µF	0.043Ω	1205mA	12x16.5	1	1	EEVFC1A102LQ
	35V	330µF	0.065Ω	1205mA	12.5x16	1	1	EEVFC1V331LQ
	16V	330µF	0.150Ω	670mA	10x10.2	N/R	1	EEVFC1C331P
Oscon- SS SV	10V	330µF	0.025Ω	>3500mA	10.0x10.5	1	1	10SS330M
	10V	330µF	0.025Ω	>3800mA	10.3x10.3	1	1	10SV300M
	20V	150µF	0.024+2 Ω	3600mA	10.3x10.3	2	2	20SV150M SV= Surface Mount
AVX Tantalum TPS	10V	330µF	0.100+2 Ω	>2500mA	7.3Lx	2	1	TPSV337M010R0100
	10V	330µF	0.100+2 Ω	>3000mA	4.3Wx	2	1	TPSV337M010R0060
	10V	220µF	0.095Ω	>2000mA	4.1H	2	2	TPSV227M0105R0100
Kemet T510/T495	10V	330µF	0.033Ω	1400mA	7.3Lx5.7W x 4.0H	2	1	T510X337M010AS
	10V	220µF	0.07Ω+2 =0.035Ω	>2000mA		2	2	T495X227M010AS
Sprague 594D	10V	330µF	0.045Ω	2350mA	7.3Lx	2	1	4D337X0010R2T
	10V	220µF	0.065Ω	>2000mA	6.0Wx 4.1H	2	2	594D227X0010D2T

N/R –Not recommended. The voltage rating does not meet the minimum operating limits.



### Adjusting the Output Voltage of the PT6935 Dual Output Voltage ISRs

Each output voltage from the PT6935 series of ISRs can be independently adjusted higher or lower than the factory trimmed pre-set voltage. The voltages,  $V_{O1}$  and  $V_{O2}$  may each be adjusted either up or down using a single external resistor <sup>1</sup>. Table 1 gives the adjustment range for both  $V_{O1}$  and  $V_{O2}$  for each model in the series as  $V_a(\text{min})$  and  $V_a(\text{max})$ . Note that  $V_{O2}$  must always be lower than  $V_{O1}$  <sup>2</sup>.

**Vo<sub>1</sub> Adjust Up:** To increase the output, add a resistor R4 between pin 16 (V<sub>1</sub> Adjust) and pins 7-11 (GND) <sup>1</sup>.

**Vo<sub>1</sub> Adjust Down:** Add a resistor (R3), between pin 16 (Vo<sub>1</sub> Adjust) and pin 1 (Vo<sub>1</sub> Sense) <sup>1</sup>.

**Vo<sub>2</sub> Adjust Up:** Add a resistor R2 between pin 23 (Vo<sub>2</sub> Adjust) and pins 7-11 (GND) <sup>1</sup>.

**Vo<sub>2</sub> Adjust Down:** Add a resistor (R1) between pin 23 (Vo<sub>2</sub> Adjust) and pin 22 (Vo<sub>2</sub> Sense) <sup>1</sup>.

Refer to Figure 1 and Table 2 for both the placement and value of the required resistor.

**Notes:**

1. Use only a single 1% resistor in either the (R3) or R4 location to adjust  $V_{O1}$ , and in the (R1) or R2 location to adjust  $V_{O2}$ . Place the resistor as close to the ISR as possible.
2.  $V_{O2}$  must always be at least 0.2V lower than  $V_{O1}$ .
3. Both the  $V_{O1}$  and  $V_{O2}$  may be adjusted down to an alternative bus voltage by making, (R3) or (R1) respectively, a zero ohm link. Refer to the Table 1 footnotes for guidance.

4. Adjusting the  $V_{O1}$  output voltage of either the PT6935 (2.5V/1.8V model) or PT6939 (2.5V/1.2V) higher than the factory pre-trimmed output voltage, may increase the minimum input voltage specified for the part. These models must comply with the following requirements.

**PT6935/PT6939:**

$$V_{in(\text{min})} = (V_a + 0.6)V \text{ or } 3.1V, \text{ whichever is greater.}$$

5. Never connect capacitors to either the  $V_{O1}$  Adjust or  $V_{O2}$  Adjust pins. Any capacitance added to these control pins will affect the stability of the respective regulated output.
6. Adjusting either voltage ( $V_{O1}$  or  $V_{O2}$ ) may increase the power dissipation in the regulator, and change the maximum current available at either output. Consult the note on p.2 of the data sheet regarding  $V_{O1}/V_{O2}$  loading.

The adjust up and adjust down resistor values can also be calculated using the following formulas. Be sure to select the correct formula parameter from Table 1 for the output and model being adjusted.

$$(R1) \text{ or } (R3) = \frac{10(V_a - V_r)}{V_o - V_a} - R_s \quad \text{k}\Omega$$

$$(R2) \text{ or } (R4) = \frac{10 \cdot V_r}{V_a - V_o} - R_s \quad \text{k}\Omega$$

Where:  $V_o$  = Original output voltage, ( $V_{O1}$  or  $V_{O2}$ )  
 $V_a$  = Adjusted output voltage  
 $V_r$  = The reference voltage from Table 1  
 $R_s$  = The series resistance from Table 1

Figure 1

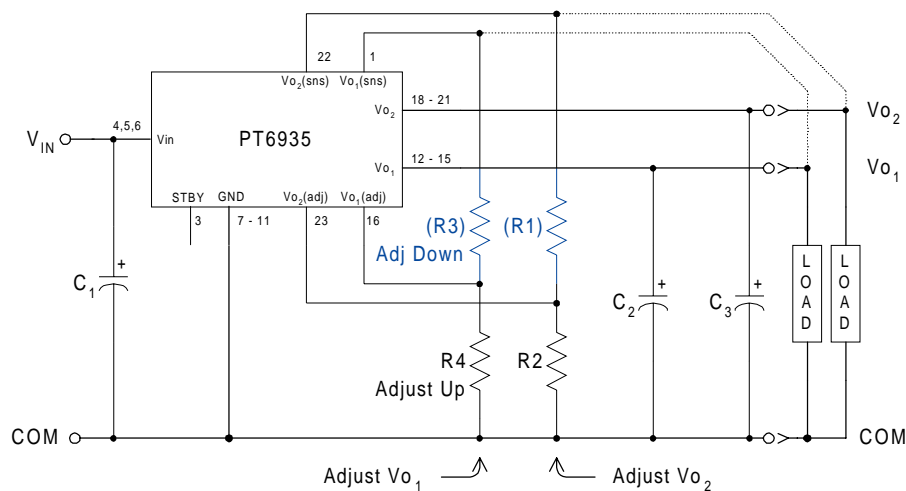

## PT6935 Series

**Table 1**

**ADJUSTMENT RANGE AND FORMULA PARAMETERS**

Vo <sub>1</sub> Bus			Vo <sub>2</sub> Bus (2)		
Series Pt #	PT6935/39	PT6936/37/38	PT6938/39	PT6935/37	PT6936
Adj. Resistor	(R3)/R4	(R3)/R4	(R1)/R2	(R1)/R2	(R1)/R2
V <sub>o</sub> (nom)	2.5V	3.3V	1.2V	1.8V	2.5V
V <sub>a</sub> (min)	1.8V *	2.5V *	1.0V †	1.5V †	1.8V †
V <sub>a</sub> (max)	3.6V (4)	3.6V	1.5V #	2.4V	3.0
V <sub>r</sub>	1.27V	1.27V	0.6125V	1.0V	1.0V
R <sub>s</sub> (kΩ)	7.5	15.4	20.0	16.9	11.5

Ref. Note 3: \* (R3) = Zero-ohm link  
 † (R1) = Zero-ohm link  
 # (R2) = Zero-ohm link

**Table 2**

**ADJUSTMENT RESISTOR VALUES**

Vo <sub>1</sub> Bus			Vo <sub>2</sub> Bus			
Series Pt #	PT6935/39	PT6936/37/38	Series Pt #	PT6938/39	PT6935/37	PT6936
Adj. Resistor	(R3)/R4	(R3)/R4	Adj. Resistor	(R1)/R2	(R1)/R2	(R1)/R2
V <sub>o</sub> (nom)	2.5V	3.3V	V <sub>o</sub> (nom)	1.2V	1.8V	2.5V
V <sub>a</sub> (req'd)			V <sub>a</sub> (req'd)			
1.8	(0.0)		1.0	(0.0)kΩ		
1.85	(1.4)kΩ		1.05	(9.2)kΩ		
1.9	(3.0)kΩ		1.1	(28.8)kΩ		
1.95	(4.9)kΩ		1.15	(87.5)kΩ		
2.0	(7.1)kΩ		1.2			
2.05	(9.8)kΩ		1.25	101.5kΩ		
2.1	(13.3)kΩ		1.3	41.2kΩ		
2.2	(23.5)kΩ		1.35	20.8kΩ		
2.3	(44.0)kΩ		1.4	10.6kΩ		
2.4	(106.0)kΩ		1.45	4.5kΩ		
2.5		(0.0)kΩ	1.5	0.0kΩ	(0.0)kΩ	
2.6	120.0kΩ	(3.6)kΩ	1.55		(5.1)kΩ	
2.7	56.0kΩ	(8.4)kΩ	1.6		(13.1)kΩ	
2.8	34.8kΩ	(15.2)kΩ	1.65		(26.4)kΩ	
2.9	24.3kΩ	(25.4)kΩ	1.7		(53.1)kΩ	
3.0	17.9kΩ	(42.3)kΩ	1.75		(133.0)kΩ	
3.1	13.7kΩ	(76.1)kΩ	1.8			(0.0)kΩ
3.2	10.6kΩ	(178.0)kΩ	1.85		183.0kΩ	(1.6)kΩ
3.3	8.4kΩ		1.9		83.1kΩ	(3.5)kΩ
3.4	6.6kΩ	112.0k	1.95		49.8kΩ	(5.8)kΩ
3.5	5.2kΩ	48.1k	2.0		33.1kΩ	(8.5)kΩ
3.6	4.1kΩ	26.9k	2.05		23.1kΩ	(11.8)kΩ
			2.1		16.4kΩ	(16.0)kΩ
			2.2		8.1kΩ	(28.5)kΩ
			2.3		3.1kΩ	(53.5)kΩ
			2.4		0.0kΩ	(129.0)kΩ
			2.5			
			2.6			88.5kΩ
			2.7			38.5kΩ
			2.8			21.8kΩ
			2.9			13.5kΩ
			3.0			8.5kΩ

R<sub>1</sub>/R<sub>3</sub> = (Blue), R<sub>2</sub>/R<sub>4</sub> = Black

### Using the Standby Function on the PT6935 Series of Dual-Output Voltage Regulators

Both output voltages of the 23-pin PT6935 dual-output converter may be disabled using the regulator's 'Standby' function. This function may be used in applications that require power-up/shutdown sequencing, or wherever there is a requirement to control the output voltage On/Off status with external circuitry.

The standby function is provided by the *STBY*\* control (pin 3). If pin 3 is left open-circuit the regulator operates normally, and provides a regulated output at both  $V_{O1}$  (pins 12–15) and  $V_{O2}$  (pins 18–21) whenever a valid supply voltage is applied to  $V_{in}$  (pins 4, 5, & 6) with respect to GND (pins 7–11). If a low voltage<sup>1</sup> is then applied to pin-3 both regulator outputs will be simultaneously disabled and the input current drawn by the ISR will drop to a typical value of 7mA. The standby control may also be used to hold-off both regulator outputs during the period that input power is applied.

The standby pin is ideally controlled using an open-collector (or open-drain) discrete transistor (See Figure 1). The open-circuit voltage is typically 12.6V. Table 1 gives the circuit parameters for this control input.

**Table 1 Standby Control Parameters**<sup>1, 2</sup>

Parameter	Min	Max
Enable ( $V_{IH}$ )	—	Open circuit
Disable ( $V_{IL}$ )	-0.1V	0.4V <sup>1</sup>
$V_{STBY}$ (open circuit)	12.6V <sup>2</sup>	15V
$I_{STBY}$ ( $I_{IL}$ )	—	-0.5mA

**Notes:**

1. The standby control input is Not compatible with TTL or other devices that incorporate a totem-pole output drive. Use only a true open-collector device, preferably a discrete bipolar transistor (or MOSFET). To ensure the regulator output is disabled, the control pin must be pulled to less than 0.4Vdc with a low-level 0.5mA sink to ground.
2. The standby control input requires no external pull-up resistor. The open-circuit voltage of the *STBY*\* pin is typically 12.6V.
3. When the regulator output is disabled the current drawn from the input source is typically reduced to 7mA.

**Figure 1**

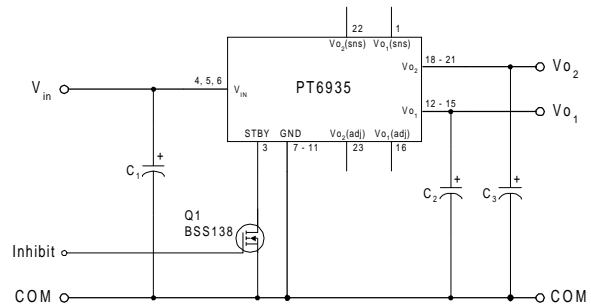

**Turn-On Time:** Turning  $Q_1$  in Figure 1 off removes the low-voltage signal at pin 3 and enables the PT6935 regulator. Following a delay of about 15ms,  $V_{O1}$  and  $V_{O2}$  rise together until the lower voltage,  $V_{O2}$ , reaches its set output.  $V_{O1}$  continues to rise until both outputs reach full regulation voltage. The total power-up time is less than 30ms, and is relatively independent of load, temperature, and output capacitance. Figure 2 shows waveforms of the output voltages,  $V_{O1}$  and  $V_{O2}$ , for a PT6937 (3.3V/1.8V). The turn-off of  $Q_1$  corresponds to the rise in  $V_{STBY}$ . The waveforms were measured with a 5V input voltage, and with resistive loads of 4.5A and 1.9A at the  $V_{O1}$  and  $V_{O2}$  outputs respectively.

**Figure 2**

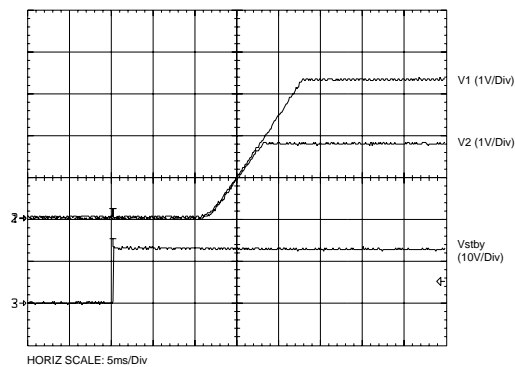

**PACKAGING INFORMATION**

Orderable Device	Status (1)	Package Type	Package Drawing	Pins	Package Qty	Eco Plan (2)	Lead/Ball Finish	MSL Peak Temp (3)	Op Temp (°C)	Top-Side Markings (4)	Samples
PT6936A	LIFEBUY	SIP MODULE	ELG	23	10	Pb-Free (RoHS)	Call TI	N / A for Pkg Type	-40 to 85		
PT6936C	LIFEBUY	SIP MODULE	ELH	23	10	Pb-Free (RoHS)	Call TI	Level-3-215C-168HRS	-40 to 85		
PT6936N	LIFEBUY	SIP MODULE	ELF	23	10	Pb-Free (RoHS)	Call TI	N / A for Pkg Type	-40 to 85		
PT6937A	LIFEBUY	SIP MODULE	ELG	23	10	Pb-Free (RoHS)	Call TI	N / A for Pkg Type	-40 to 85		
PT6937C	LIFEBUY	SIP MODULE	ELH	23	10	Pb-Free (RoHS)	Call TI	Level-3-215C-168HRS	-40 to 85		
PT6938C	LIFEBUY	SIP MODULE	ELH	23	10	Pb-Free (RoHS)	Call TI	Level-3-215C-168HRS			
PT6938N	LIFEBUY	SIP MODULE	ELF	23	10	Pb-Free (RoHS)	Call TI	N / A for Pkg Type			
PT6939A	LIFEBUY	SIP MODULE	ELG	23	10	Pb-Free (RoHS)	Call TI	N / A for Pkg Type			

(1) The marketing status values are defined as follows:

**ACTIVE:** Product device recommended for new designs.

**LIFEBUY:** TI has announced that the device will be discontinued, and a lifetime-buy period is in effect.

**NRND:** Not recommended for new designs. Device is in production to support existing customers, but TI does not recommend using this part in a new design.

**PREVIEW:** Device has been announced but is not in production. Samples may or may not be available.

**OBSOLETE:** TI has discontinued the production of the device.

(2) Eco Plan - The planned eco-friendly classification: Pb-Free (RoHS), Pb-Free (RoHS Exempt), or Green (RoHS & no Sb/Br) - please check <http://www.ti.com/productcontent> for the latest availability information and additional product content details.

**TBD:** The Pb-Free/Green conversion plan has not been defined.

**Pb-Free (RoHS):** TI's terms "Lead-Free" or "Pb-Free" mean semiconductor products that are compatible with the current RoHS requirements for all 6 substances, including the requirement that lead not exceed 0.1% by weight in homogeneous materials. Where designed to be soldered at high temperatures, TI Pb-Free products are suitable for use in specified lead-free processes.

**Pb-Free (RoHS Exempt):** This component has a RoHS exemption for either 1) lead-based flip-chip solder bumps used between the die and package, or 2) lead-based die adhesive used between the die and leadframe. The component is otherwise considered Pb-Free (RoHS compatible) as defined above.

**Green (RoHS & no Sb/Br):** TI defines "Green" to mean Pb-Free (RoHS compatible), and free of Bromine (Br) and Antimony (Sb) based flame retardants (Br or Sb do not exceed 0.1% by weight in homogeneous material)

(3) MSL, Peak Temp. -- The Moisture Sensitivity Level rating according to the JEDEC industry standard classifications, and peak solder temperature.

<sup>(4)</sup> Multiple Top-Side Markings will be inside parentheses. Only one Top-Side Marking contained in parentheses and separated by a "~" will appear on a device. If a line is indented then it is a continuation of the previous line and the two combined represent the entire Top-Side Marking for that device.

**Important Information and Disclaimer:** The information provided on this page represents TI's knowledge and belief as of the date that it is provided. TI bases its knowledge and belief on information provided by third parties, and makes no representation or warranty as to the accuracy of such information. Efforts are underway to better integrate information from third parties. TI has taken and continues to take reasonable steps to provide representative and accurate information but may not have conducted destructive testing or chemical analysis on incoming materials and chemicals. TI and TI suppliers consider certain information to be proprietary, and thus CAS numbers and other limited information may not be available for release.

In no event shall TI's liability arising out of such information exceed the total purchase price of the TI part(s) at issue in this document sold by TI to Customer on an annual basis.

## IMPORTANT NOTICE

Texas Instruments Incorporated and its subsidiaries (TI) reserve the right to make corrections, enhancements, improvements and other changes to its semiconductor products and services per JESD46, latest issue, and to discontinue any product or service per JESD48, latest issue. Buyers should obtain the latest relevant information before placing orders and should verify that such information is current and complete. All semiconductor products (also referred to herein as "components") are sold subject to TI's terms and conditions of sale supplied at the time of order acknowledgment.

TI warrants performance of its components to the specifications applicable at the time of sale, in accordance with the warranty in TI's terms and conditions of sale of semiconductor products. Testing and other quality control techniques are used to the extent TI deems necessary to support this warranty. Except where mandated by applicable law, testing of all parameters of each component is not necessarily performed.

TI assumes no liability for applications assistance or the design of Buyers' products. Buyers are responsible for their products and applications using TI components. To minimize the risks associated with Buyers' products and applications, Buyers should provide adequate design and operating safeguards.

TI does not warrant or represent that any license, either express or implied, is granted under any patent right, copyright, mask work right, or other intellectual property right relating to any combination, machine, or process in which TI components or services are used. Information published by TI regarding third-party products or services does not constitute a license to use such products or services or a warranty or endorsement thereof. Use of such information may require a license from a third party under the patents or other intellectual property of the third party, or a license from TI under the patents or other intellectual property of TI.

Reproduction of significant portions of TI information in TI data books or data sheets is permissible only if reproduction is without alteration and is accompanied by all associated warranties, conditions, limitations, and notices. TI is not responsible or liable for such altered documentation. Information of third parties may be subject to additional restrictions.

Resale of TI components or services with statements different from or beyond the parameters stated by TI for that component or service voids all express and any implied warranties for the associated TI component or service and is an unfair and deceptive business practice. TI is not responsible or liable for any such statements.

Buyer acknowledges and agrees that it is solely responsible for compliance with all legal, regulatory and safety-related requirements concerning its products, and any use of TI components in its applications, notwithstanding any applications-related information or support that may be provided by TI. Buyer represents and agrees that it has all the necessary expertise to create and implement safeguards which anticipate dangerous consequences of failures, monitor failures and their consequences, lessen the likelihood of failures that might cause harm and take appropriate remedial actions. Buyer will fully indemnify TI and its representatives against any damages arising out of the use of any TI components in safety-critical applications.

In some cases, TI components may be promoted specifically to facilitate safety-related applications. With such components, TI's goal is to help enable customers to design and create their own end-product solutions that meet applicable functional safety standards and requirements. Nonetheless, such components are subject to these terms.

No TI components are authorized for use in FDA Class III (or similar life-critical medical equipment) unless authorized officers of the parties have executed a special agreement specifically governing such use.

Only those TI components which TI has specifically designated as military grade or "enhanced plastic" are designed and intended for use in military/aerospace applications or environments. Buyer acknowledges and agrees that any military or aerospace use of TI components which have **not** been so designated is solely at the Buyer's risk, and that Buyer is solely responsible for compliance with all legal and regulatory requirements in connection with such use.

TI has specifically designated certain components as meeting ISO/TS16949 requirements, mainly for automotive use. In any case of use of non-designated products, TI will not be responsible for any failure to meet ISO/TS16949.

### Products

Audio	<a href="http://www.ti.com/audio">www.ti.com/audio</a>
Amplifiers	<a href="http://amplifier.ti.com">amplifier.ti.com</a>
Data Converters	<a href="http://dataconverter.ti.com">dataconverter.ti.com</a>
DLP® Products	<a href="http://www.dlp.com">www.dlp.com</a>
DSP	<a href="http://dsp.ti.com">dsp.ti.com</a>
Clocks and Timers	<a href="http://www.ti.com/clocks">www.ti.com/clocks</a>
Interface	<a href="http://interface.ti.com">interface.ti.com</a>
Logic	<a href="http://logic.ti.com">logic.ti.com</a>
Power Mgmt	<a href="http://power.ti.com">power.ti.com</a>
Microcontrollers	<a href="http://microcontroller.ti.com">microcontroller.ti.com</a>
RFID	<a href="http://www.ti-rfid.com">www.ti-rfid.com</a>
OMAP Applications Processors	<a href="http://www.ti.com/omap">www.ti.com/omap</a>
Wireless Connectivity	<a href="http://www.ti.com/wirelessconnectivity">www.ti.com/wirelessconnectivity</a>

### Applications

Automotive and Transportation	<a href="http://www.ti.com/automotive">www.ti.com/automotive</a>
Communications and Telecom	<a href="http://www.ti.com/communications">www.ti.com/communications</a>
Computers and Peripherals	<a href="http://www.ti.com/computers">www.ti.com/computers</a>
Consumer Electronics	<a href="http://www.ti.com/consumer-apps">www.ti.com/consumer-apps</a>
Energy and Lighting	<a href="http://www.ti.com/energy">www.ti.com/energy</a>
Industrial	<a href="http://www.ti.com/industrial">www.ti.com/industrial</a>
Medical	<a href="http://www.ti.com/medical">www.ti.com/medical</a>
Security	<a href="http://www.ti.com/security">www.ti.com/security</a>
Space, Avionics and Defense	<a href="http://www.ti.com/space-avionics-defense">www.ti.com/space-avionics-defense</a>
Video and Imaging	<a href="http://www.ti.com/video">www.ti.com/video</a>

### TI E2E Community

[e2e.ti.com](http://e2e.ti.com)