

Ordering number FA11905_TINA3-S

Family	Tina3	FWHM	15 degrees
Type	Assembly	Efficiency	86 %
LED	XP-G	cd/lm	6.700
Color	White	Gerber File	Available
Diameter	16.1 mm		
Height	11.4 mm		
Style	Round		
Optic Material	PMMA		
Holder Material	PC		
Fastening	Pin, tape		
Status	On production		

Ordering number FA11824_TINA3-W

Family	Tina3	FWHM	32 degrees
Type	Assembly	Efficiency	93 %
LED	XP-G	cd/lm	1.520
Color	White	Gerber File	Available
Diameter	16.1 mm		
Height	6.9 mm		
Style	Round		
Optic Material	PMMA		
Holder Material	PC		
Fastening	Pin, tape		
Status	On production		

Ordering number CA13043_TINA3-W

Family	Tina3	FWHM	38 degrees
Type	Assembly	Efficiency	93 %
LED	XP-G	cd/lm	1.700
Color	White	Gerber File	Available
Diameter	16.1 mm		
Height	7.29 mm		
Style	Round		
Optic Material	PMMA		
Holder Material	PC		
Fastening	Tape		
Status	On production		

Ordering number FA11825_TINA3-WW

Family	Tina3	FWHM	41 degrees
Type	Assembly	Efficiency	93 %
LED	XP-G	cd/lm	1.000
Color	White	Gerber File	Available
Diameter	16.1 mm		
Height	6.9 mm		
Style	Round		
Optic Material	PMMA		
Holder Material	PC		
Fastening	Pin, tape		
Status	On production		

Ordering number CA12426_TINA3-W

Family	Tina3	FWHM	42 degrees
Type	Assembly	Efficiency	90 %
LED	XP-G	cd/lm	1.700
Color	White	Gerber File	Available
Diameter	16.1 mm		
Height	6.9 mm		
Style	Round		
Optic Material	PMMA		
Holder Material	PC		
Fastening	Pin, tape		
Status	On production		

Ordering number CA13044_TINA3-OO

Family	Tina3	FWHM	48+32 degrees
Type	Assembly	Efficiency	93 %
LED	XP-G	cd/lm	1.400
Color	White	Gerber File	Available
Diameter	16.1 mm		
Height	7.29 mm		
Style	Round		
Optic Material	PMMA		
Holder Material	PC		
Fastening	Tape		
Status	On production		

Ordering number CA12892_TINA3-WW

Family	Tina3	FWHM	50 degrees
Type	Assembly	Efficiency	93 %
LED	XP-G	cd/lm	1.200
Color	White	Gerber File	Available
Diameter	16.1 mm		
Height	7.29 mm		
Style	Round		
Optic Material	PMMA		
Holder Material	PC		
Fastening	Tape		
Status	On production		

Ordering number FA11870_TINA3-OO

Family	Tina3	FWHM	51+39 degrees
Type	Assembly	Efficiency	93 %
LED	XP-G	cd/lm	1.600
Color	White	Gerber File	Available
Diameter	16.3 mm		
Height	6.9 mm		
Style	Round		
Optic Material	PMMA		
Holder Material	PC		
Fastening	Pin, tape		
Status	On production		

Ordering number CA12429_TINA3-OO

Family	Tina3	FWHM	51+35 degrees
Type	Assembly	Efficiency	90 %
LED	XP-G	cd/lm	1.400
Color	White	Gerber File	Available
Diameter	16.1 mm		
Height	6.9 mm		
Style	Round		
Optic Material	PMMA		
Holder Material	PC		
Fastening	Pin, tape		
Status	On production		

Ordering number CA12427_TINA3-WW

Family	Tina3	FWHM	58 degrees
Type	Assembly	Efficiency	89 %
LED	XP-G	cd/lm	1.000
Color	White	Gerber File	Available
Diameter	16.1 mm		
Height	6.9 mm		
Style	Round		
Optic Material	PMMA		
Holder Material	PC		
Fastening	Pin, tape		
Status	On production		

Ordering number CA13045_TINA3-WWW

Family	Tina3	FWHM	60 degrees
Type	Assembly	Efficiency	92 %
LED	XP-G	cd/lm	0.700
Color	White	Gerber File	Available
Diameter	16.1 mm		
Height	7.29 mm		
Style	Round		
Optic Material	PMMA		
Holder Material	PC		
Fastening	Tape		
Status	On production		

Ordering number CA12428_TINA3-WWW

Family	Tina3	FWHM	69 degrees
Type	Assembly	Efficiency	87 %
LED	XP-G	cd/lm	0.700
Color	White	Gerber File	Available
Diameter	16.1 mm		
Height	6.9 mm		
Style	Round		
Optic Material	PMMA		
Holder Material	PC		
Fastening	Pin, tape		
Status	On production		



Ordering number FA11826_TINA3-WWW

Family	Tina3	FWHM	77 degrees
Type	Assembly	Efficiency	92 %
LED	XP-G	cd/lm	0.500
Color	White	Gerber File	Available
Diameter	16.1 mm		
Height	6.9 mm		
Style	Round		
Optic Material	PMMA		
Holder Material	PC		
Fastening	Pin, tape		
Status	On production		

NOTE: The typical divergence will be changed by different color, chip size and chip position tolerance. The typical total divergence is the full angle measured where the luminous intensity is half of the peak value.



PRODUCT DATASHEET

Tina3 series

last update 13/6/2013

GENERAL INFORMATION

- Product series especially designed & optimized for XP-G series of LEDs.
- Special care taken to make light distribution as uniform as possible.
- Lens material optical grade PMMA with high UV and temperature resistance. Allows use of high current and temperature conditions.

Please find more information about used material from below:

http://ledil.fi/sites/default/files/Documents/Technical/Material/PMMA%20N%20UL94_Yellow%20Card.pdf

<http://ledil.fi/sites/default/files/Documents/Technical/Material/PMMA%20N%20PLEXIGLAS-Datasheet.pdf>

- Optic holder molded by high quality PC material (120 degrees of Celcius / 248 degrees of Fahrenheit).

Relative intensity of FA11826_Tina3-WWW-XP-G

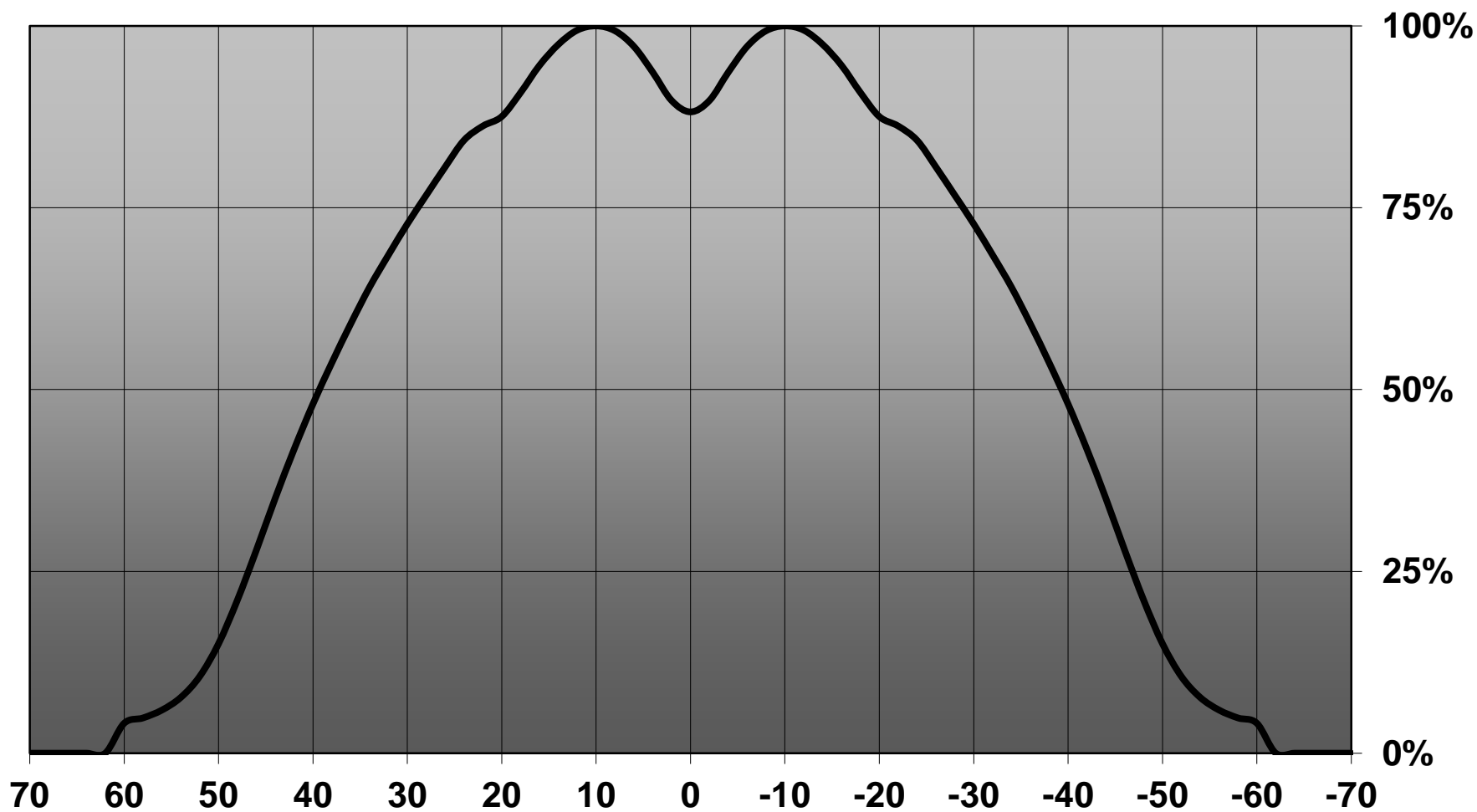

D

C

B

A

4

4

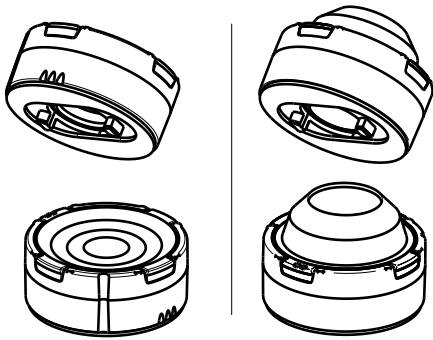

Oval beam direction

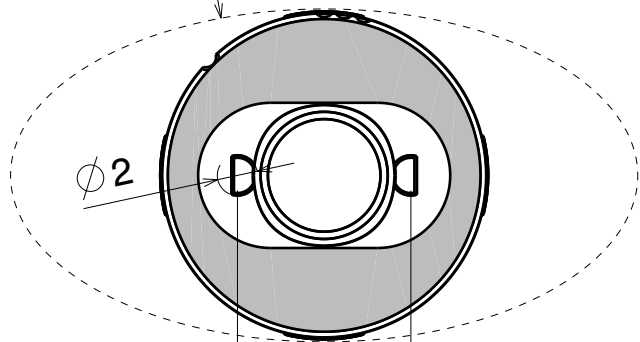

8.6

c / c

3

3

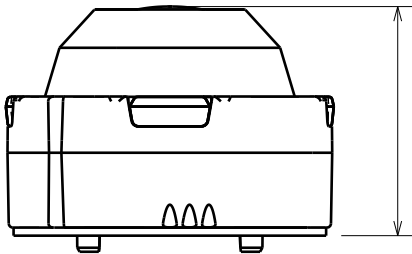

11.4

Spot version height

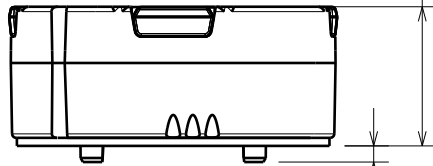

6.9

0.8

2

2

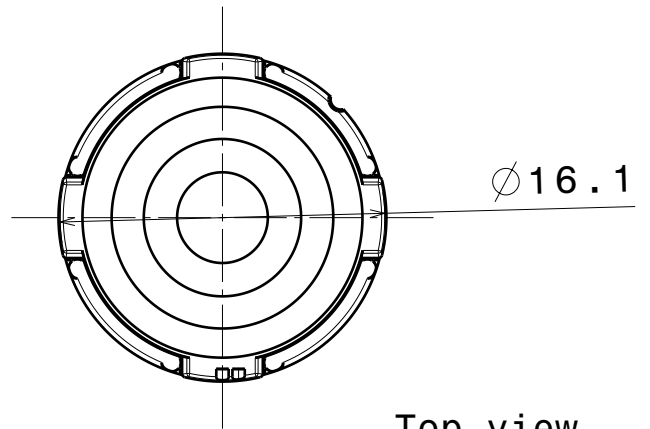

16.1

Top view

Tolerances if not otherwise shown
 According to DIN ISO 2768-1
 Linear measures:
 Up to 30mm class F, otherwise class M.
 According to DIN ISO 2768-2
 Form and position: class K

LEDiL

Ledil Oy
 Salorankatu 10
 FIN 24240 SALO
 Finland

THIRD ANGLE PROJECTION:

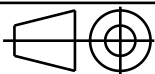

DRAWING TITLE

TINA3 Datasheet

This drawing is the property
 of LEDiL Oy. It may not be
 reproduced, copied or
 communicated without a written
 agreement with LEDiL Oy."

SIZE

A4

PART NUMBER

-

SCALE

4:3

WEIGHT

-

SHEET

1/1

D

A

1

1

Ledil FA11824_Tina3-W-XP-G FA11824_Tina3-W-XP-G / LDC (Linear)

Luminaire: Ledil FA11824_Tina3-W-XP-G FA11824_Tina3-W-XP-G
Lamps: 1 x LED Module

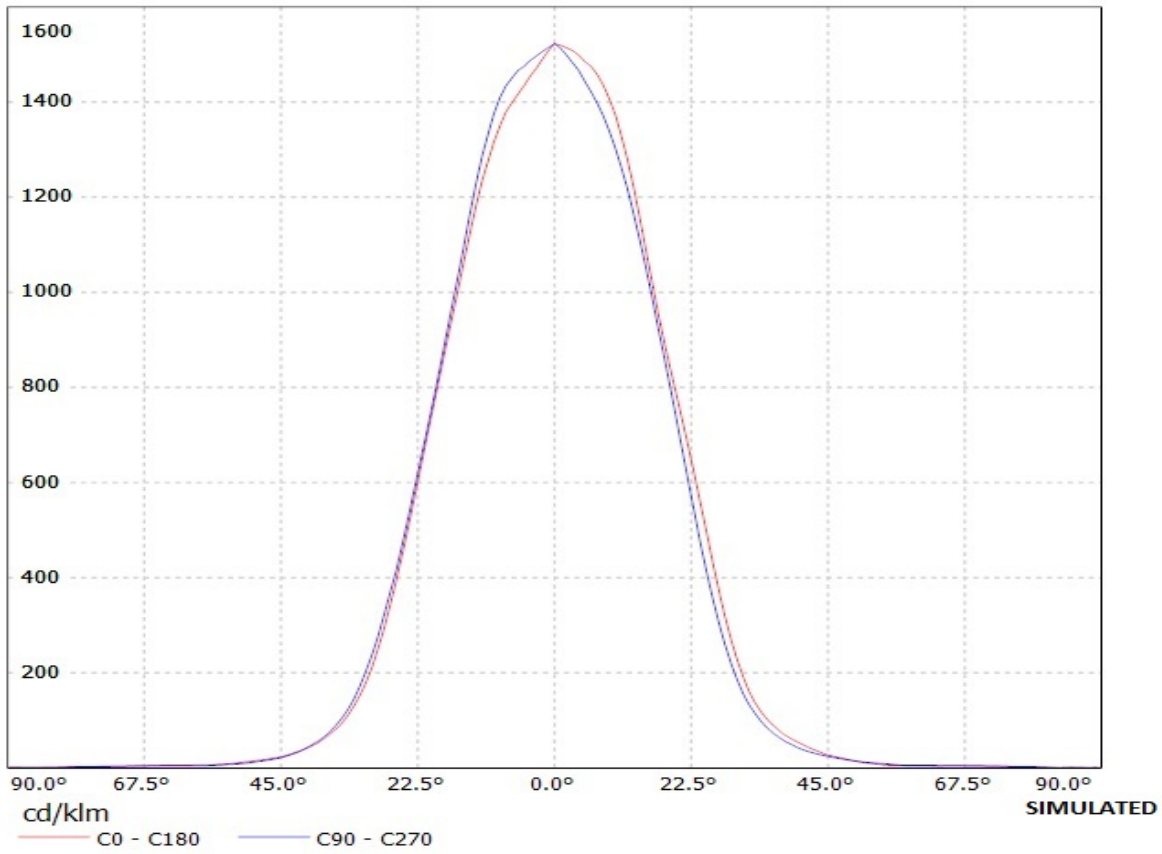

Luminaire: Ledil Oy CA13043_TINA3-W (Cree XP-G 87lm @ 250mA) Efficiency=93%
Lamps: 1 x Cree XP-G 87lm @ 250mA

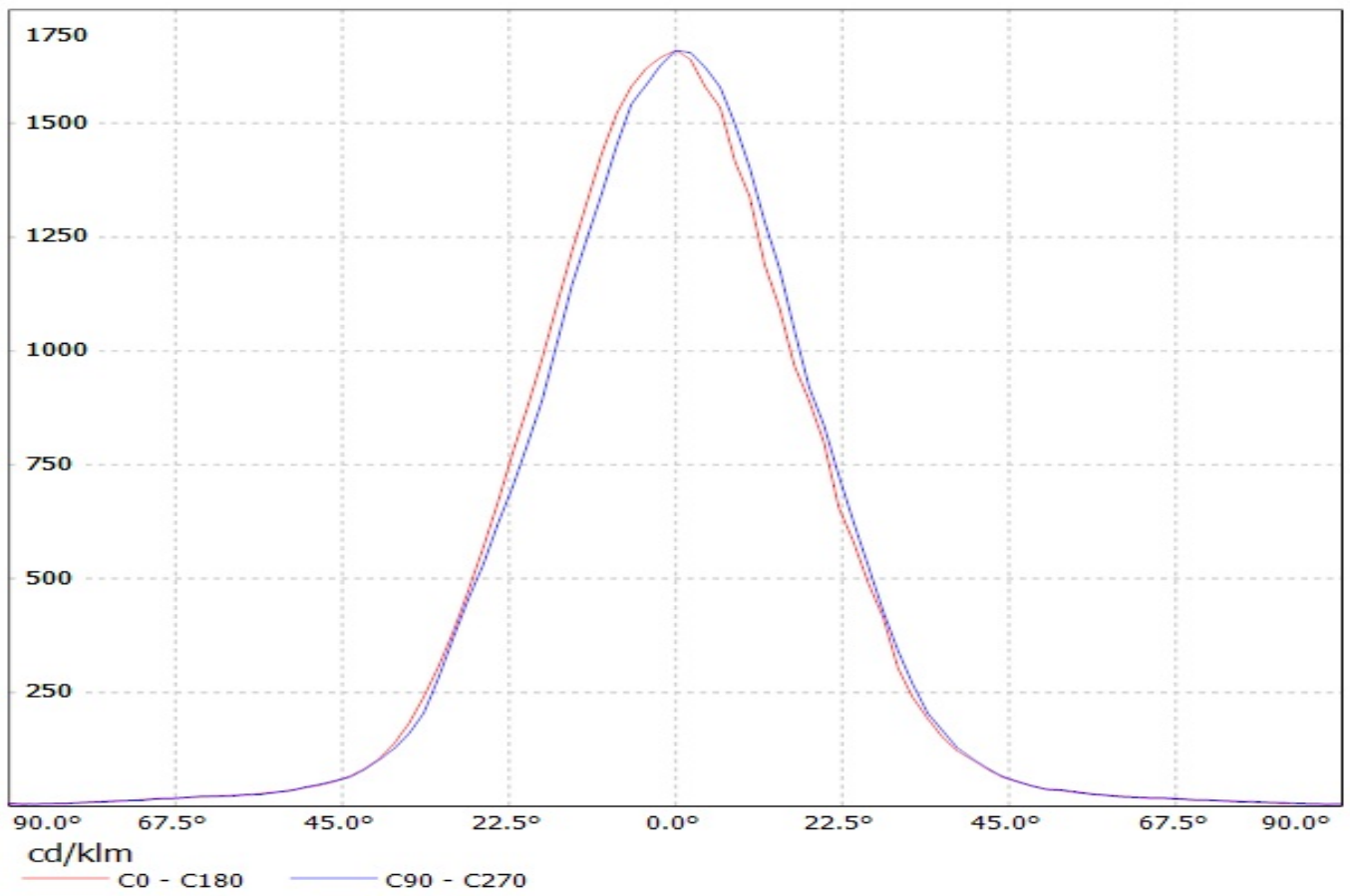

Ledil FA11825_Tina3-WW-XP-G FA11825_Tina3-WW-XP-G / LDC (Linear)

Luminaire: Ledil FA11825_Tina3-WW-XP-G FA11825_Tina3-WW-XP-G
Lamps: 1 x LED Module

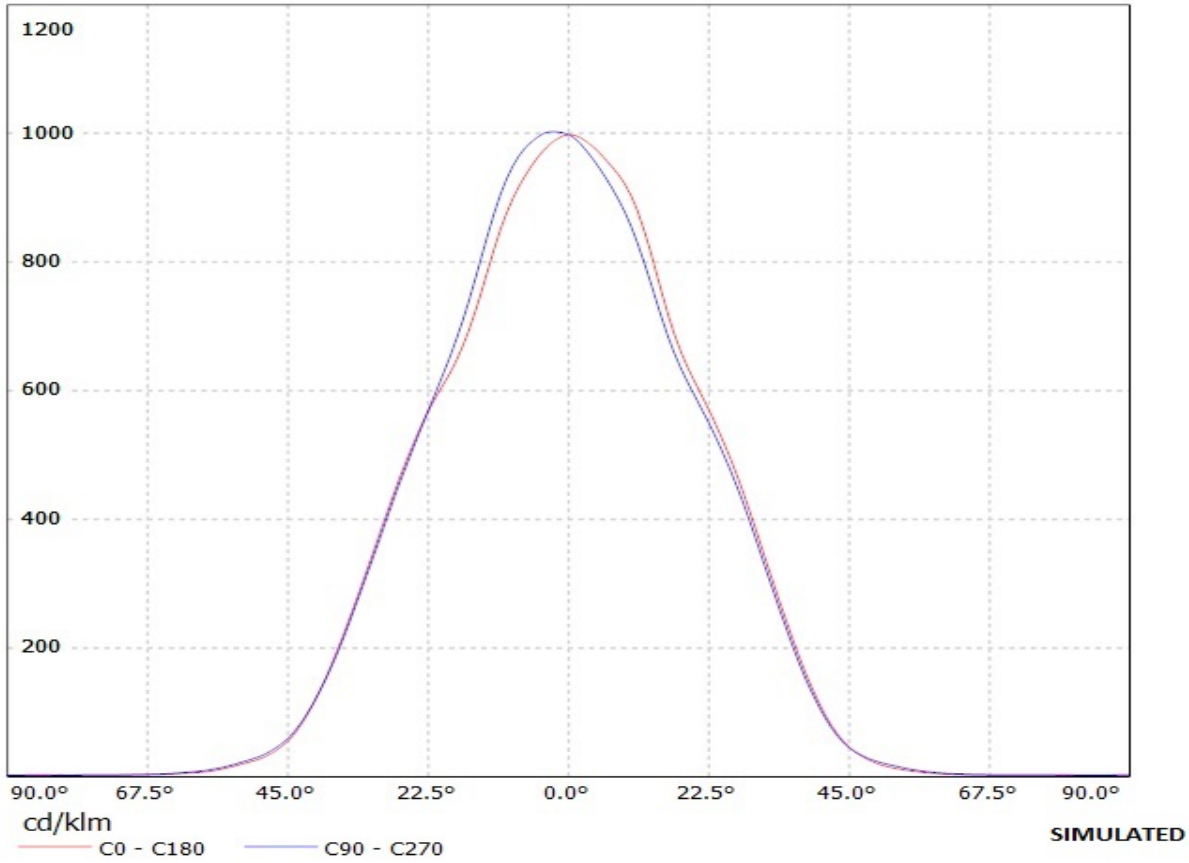

Luminaire: Ledil Oy CA12426_TINA3-W (Cree XP-G 68lm @ 250mA) Efficiency=90%
Lamps: 1 x Cree XP-G 68lm @ 250mA

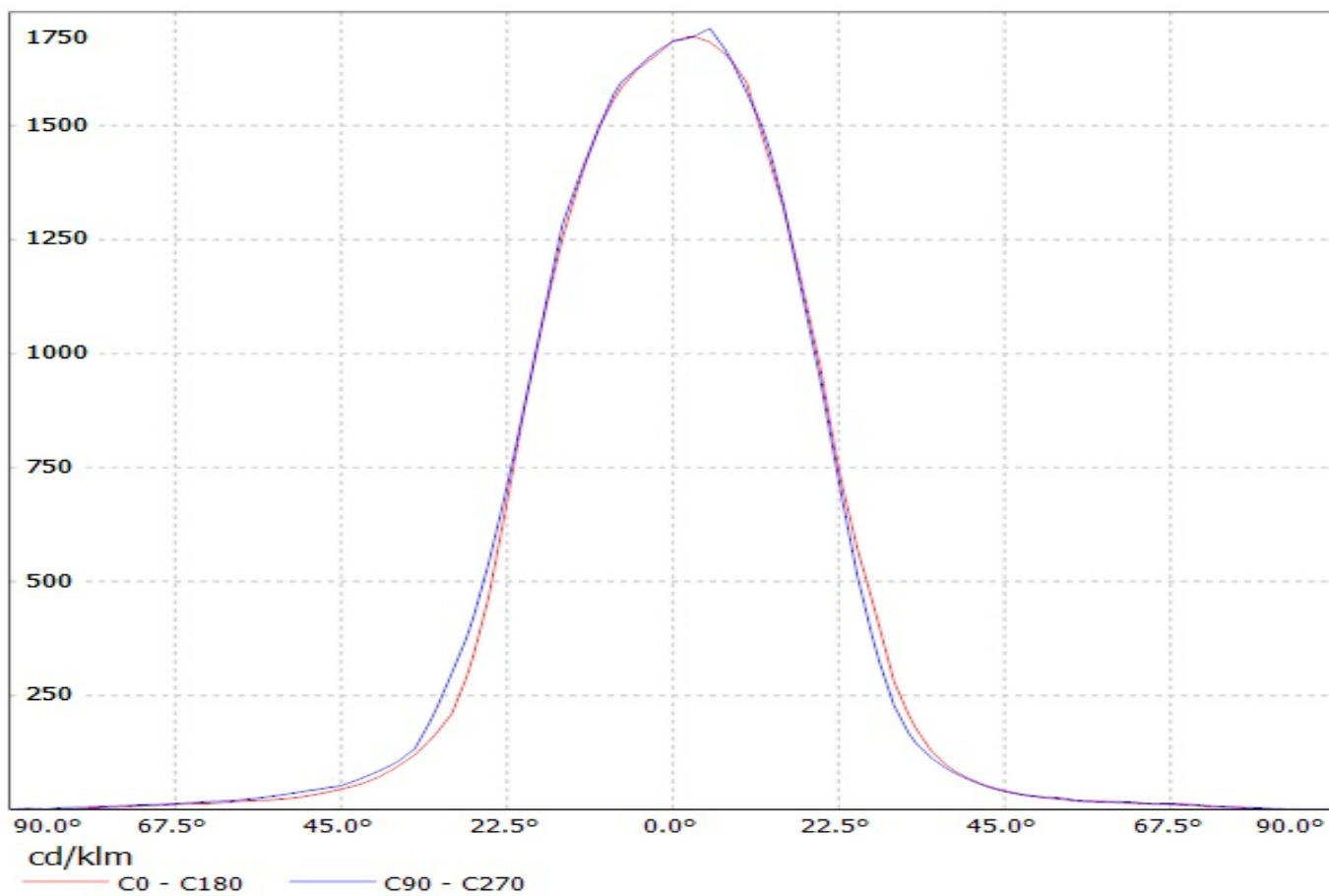

Luminaire: Ledil Oy CA13044_TINA3-00 (Cree XP-G 87lm @ 250mA) Efficiency=93%
Lamps: 1 x Cree XP-G 87lm @ 250mA

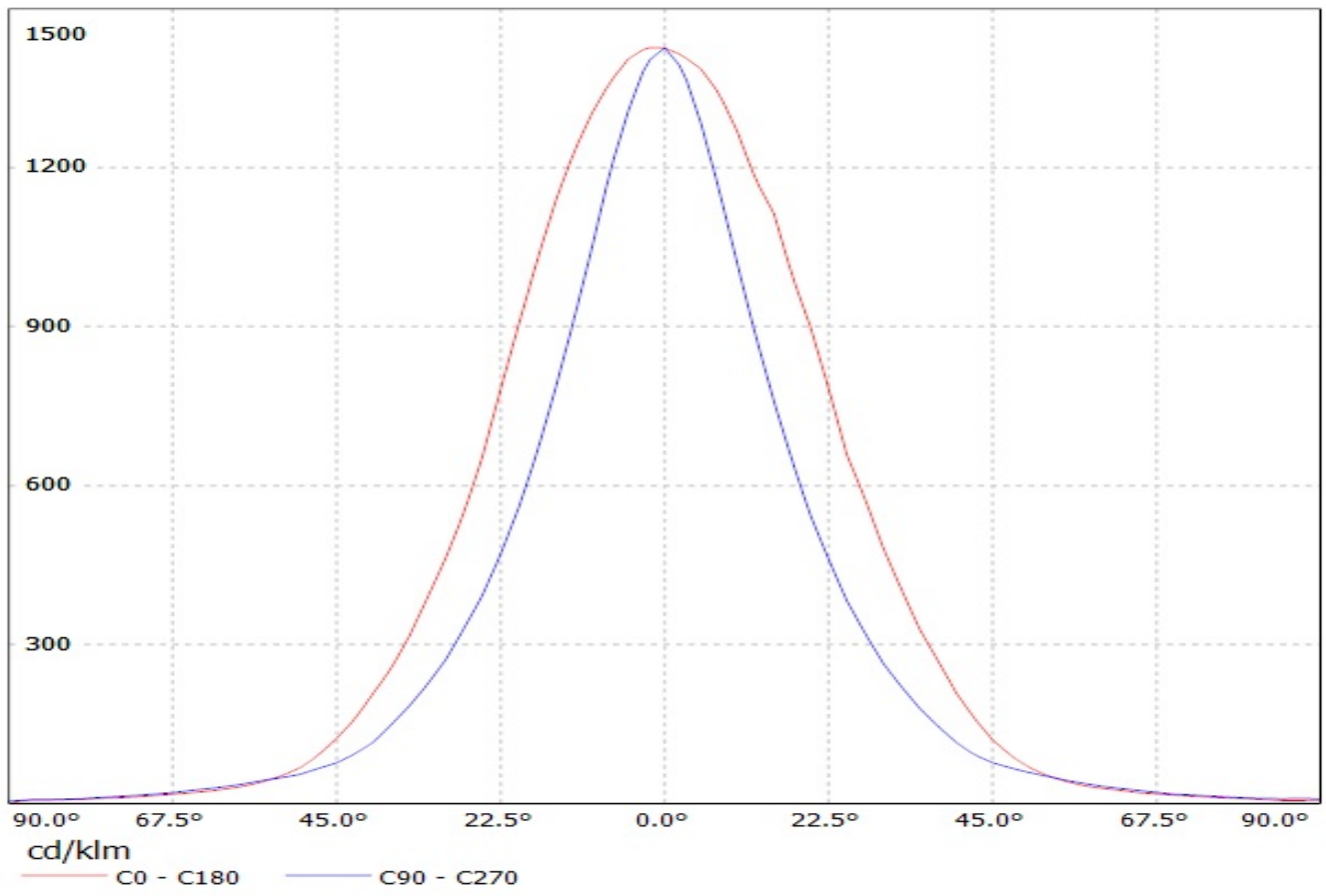

Luminaire: Ledil Oy CA12892_TINA3-WW (Cree XP-G 87lm @ 250mA) Efficiency=93%
Lamps: 1 x Cree XP-G 87lm @ 250mA

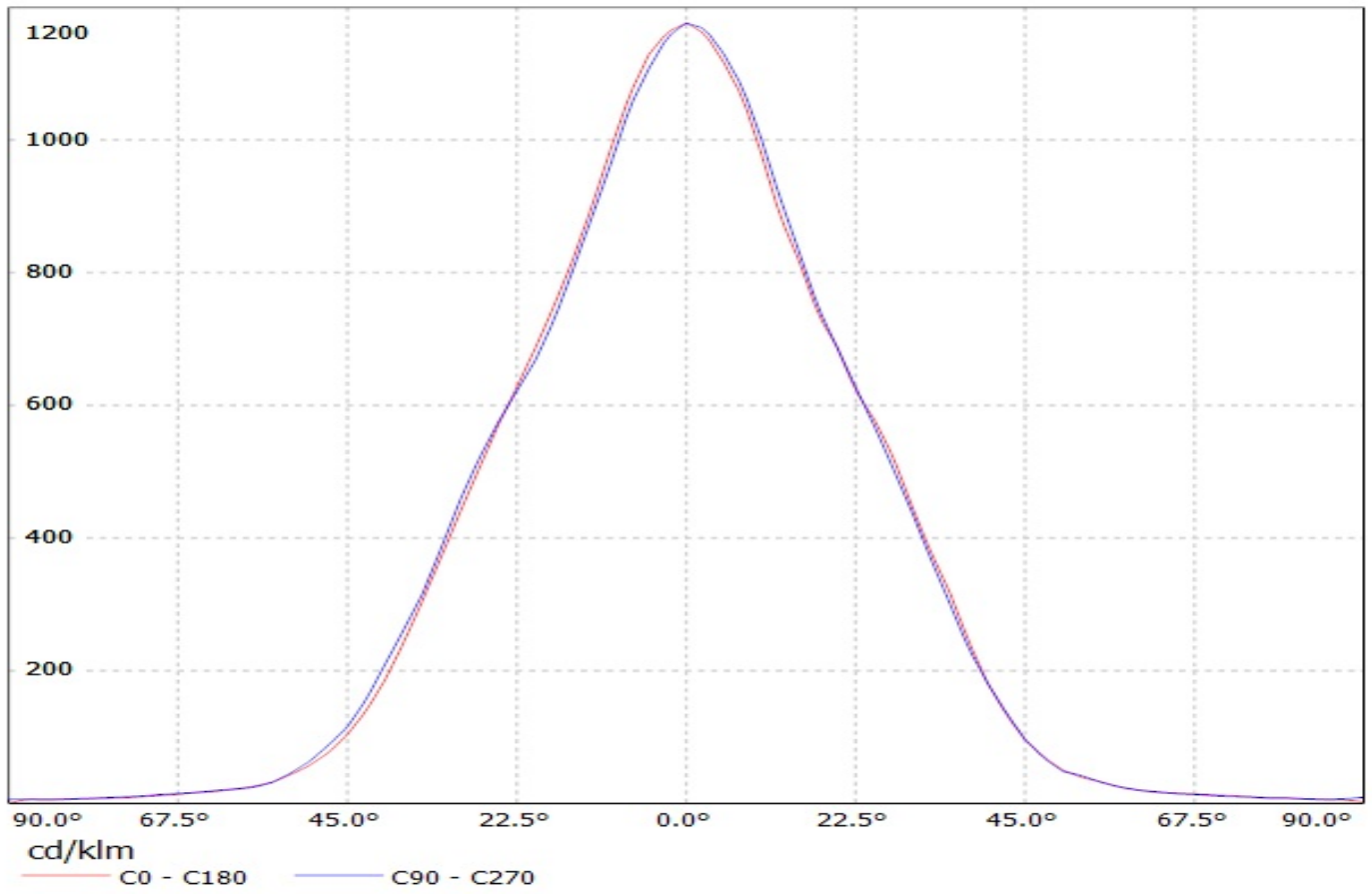

Luminaire: LEDIL OY FA11870-Tina3-OO (XP-G) Efficiency=93%
Lamps: 1 x Cree XP-G (82lm@250mA)

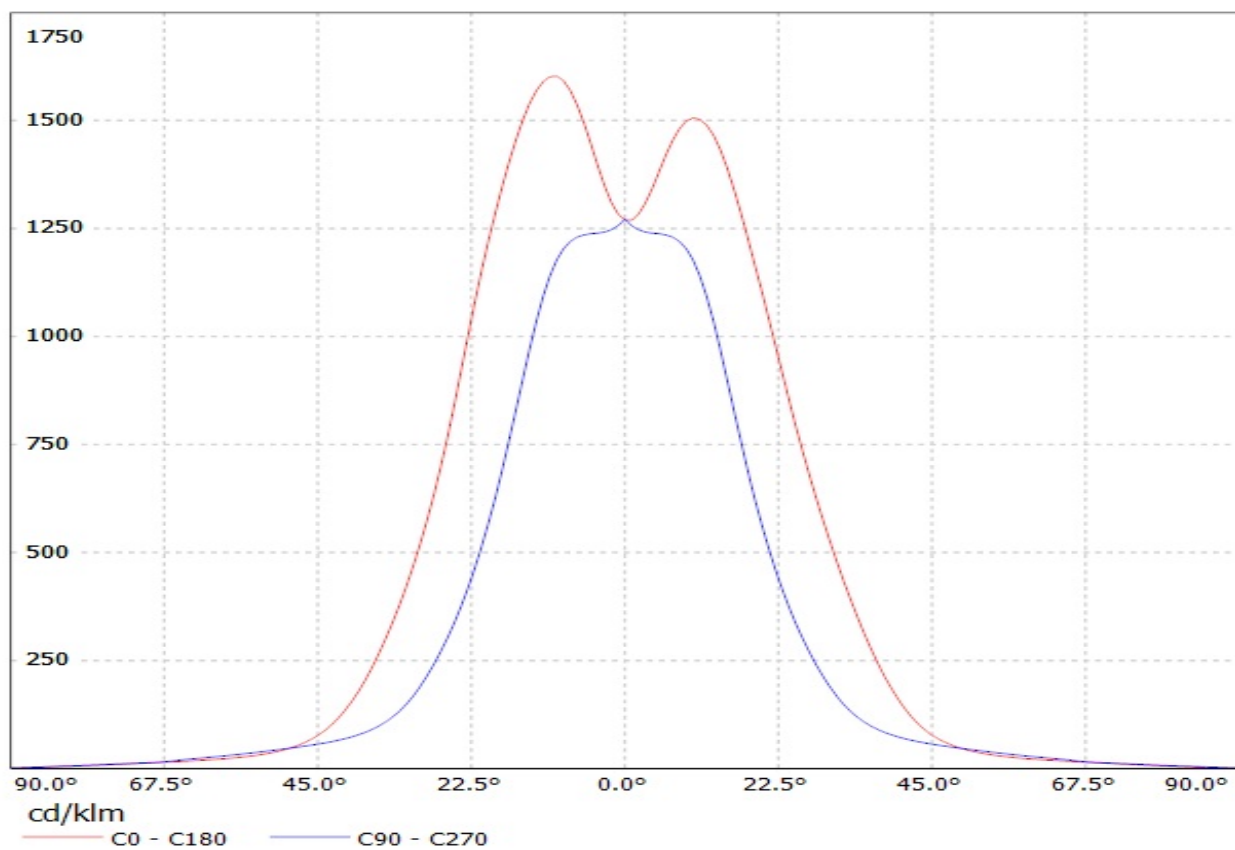

Luminaire: Ledil Oy CA12429_TINA3-00 (Cree XP-G 68lm @ 250mA) Efficiency=90%
Lamps: 1 x Cree XP-G 68lm @ 250mA

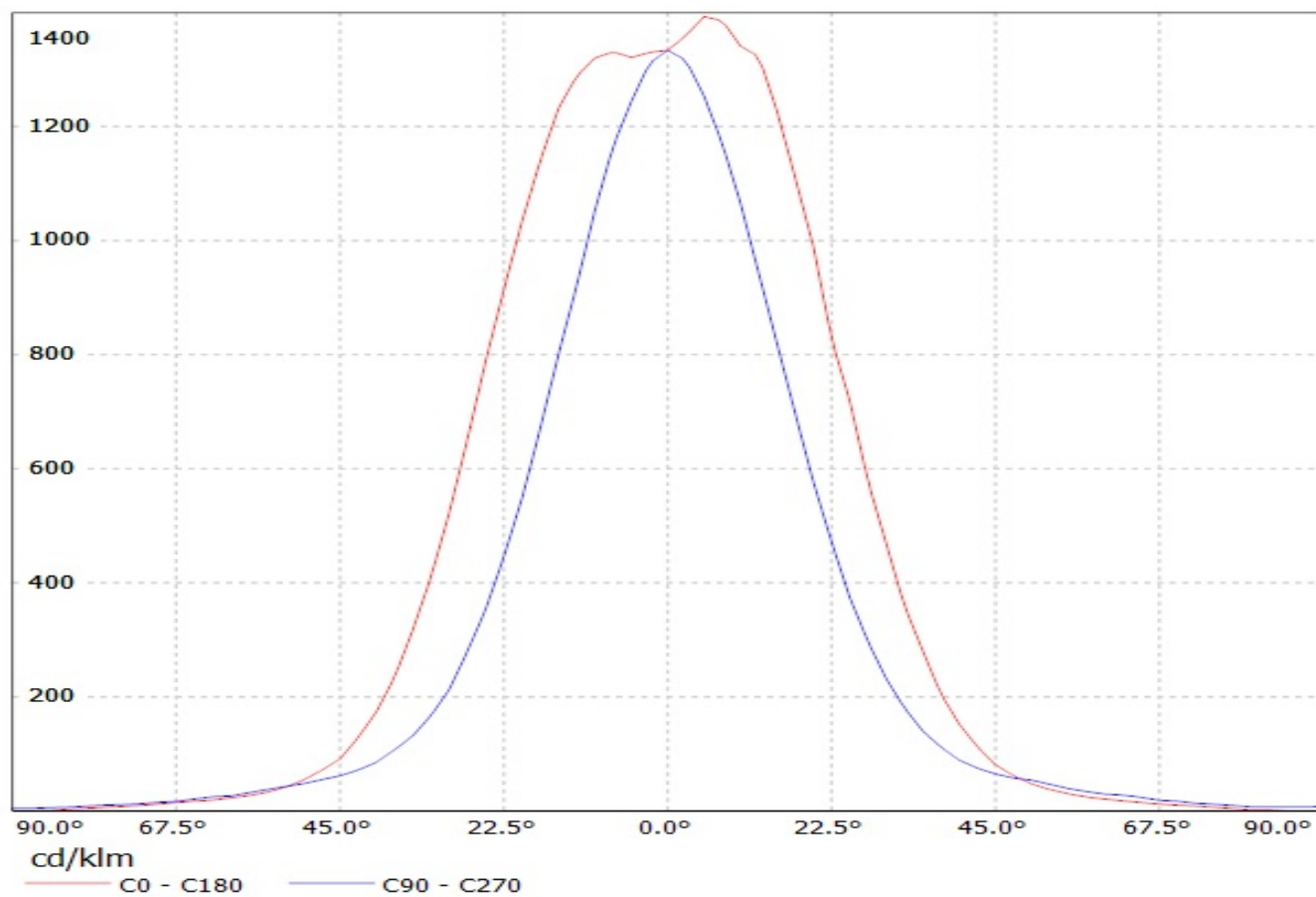

Luminaire: Ledil Oy CA12427_TINA3-WW (Cree XP-G 68lm @ 250mA) Efficiency=89%
Lamps: 1 x Cree XP-G 68lm @ 250mA

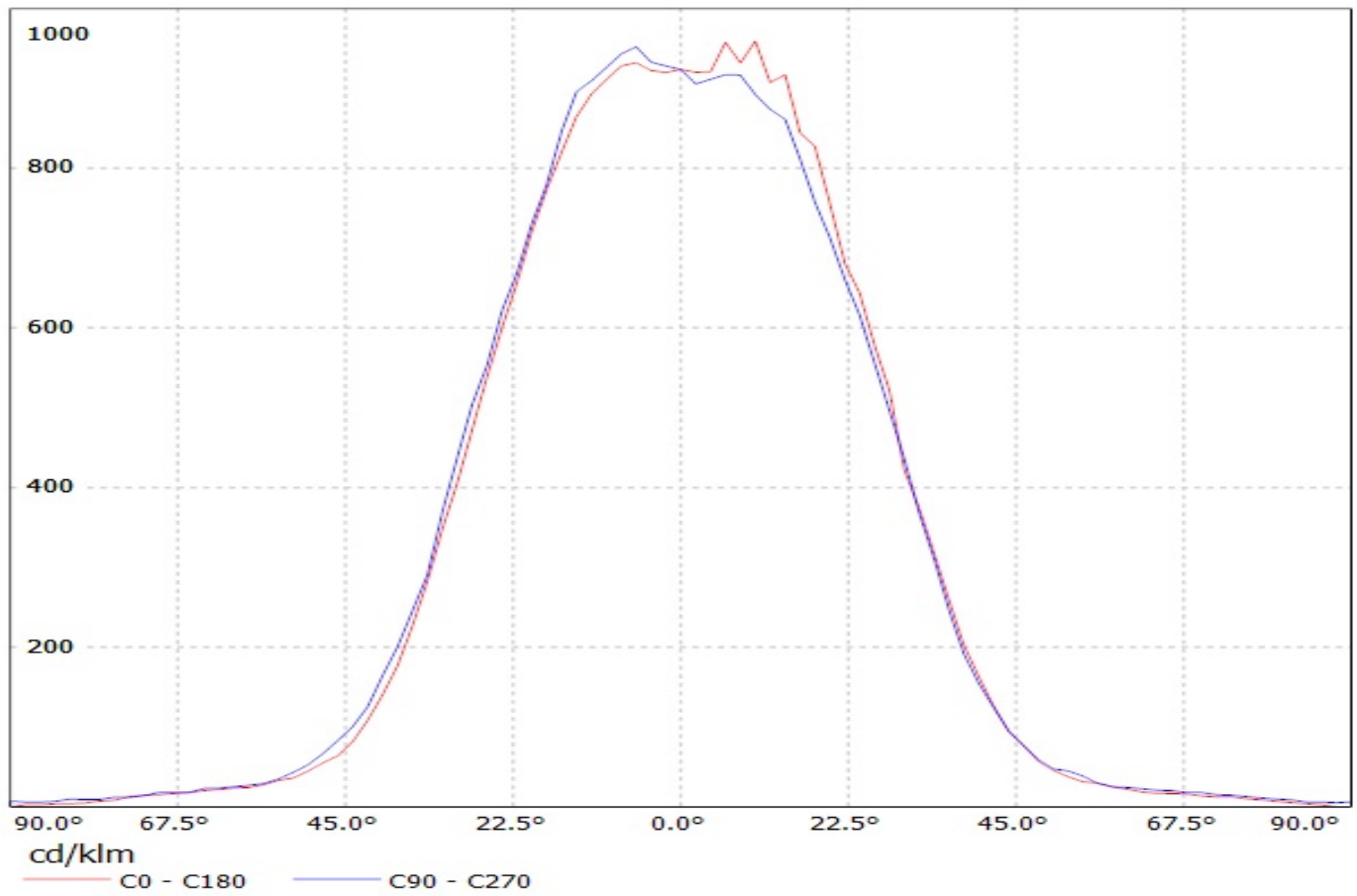

Luminaire: Ledil Oy CA13045_TINA3-WWW (Cree XP-G 87lm @ 250mA) Efficiency=92%
Lamps: 1 x Cree XP-G 87lm @ 250mA

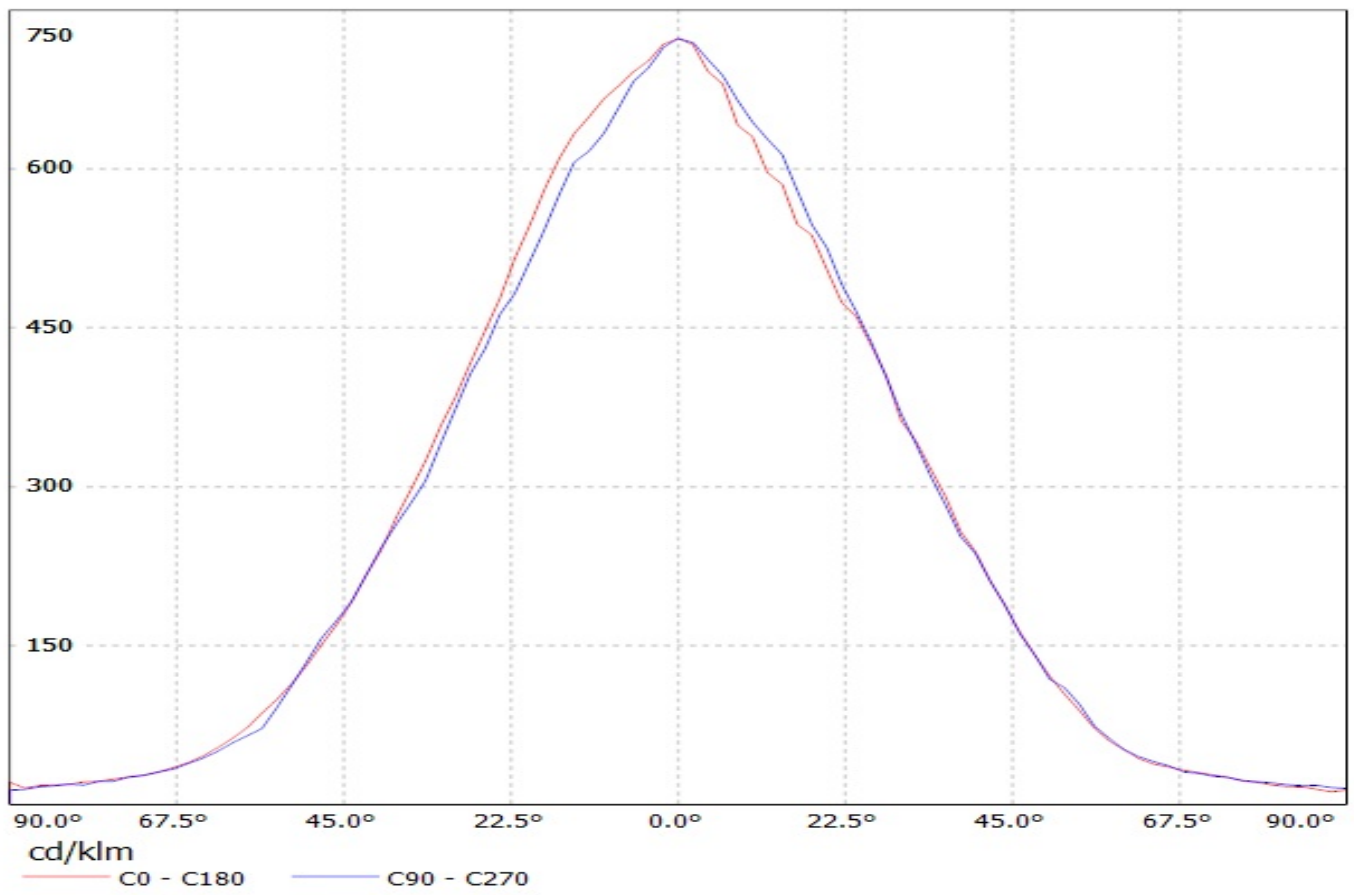

Luminaire: Ledil Oy CA12428_TINA3-WWW (Osram Square EC 68lm @ 250mA) Efficiency=87%
Lamps: 1 x Osram Square EC 68lm @ 250mA

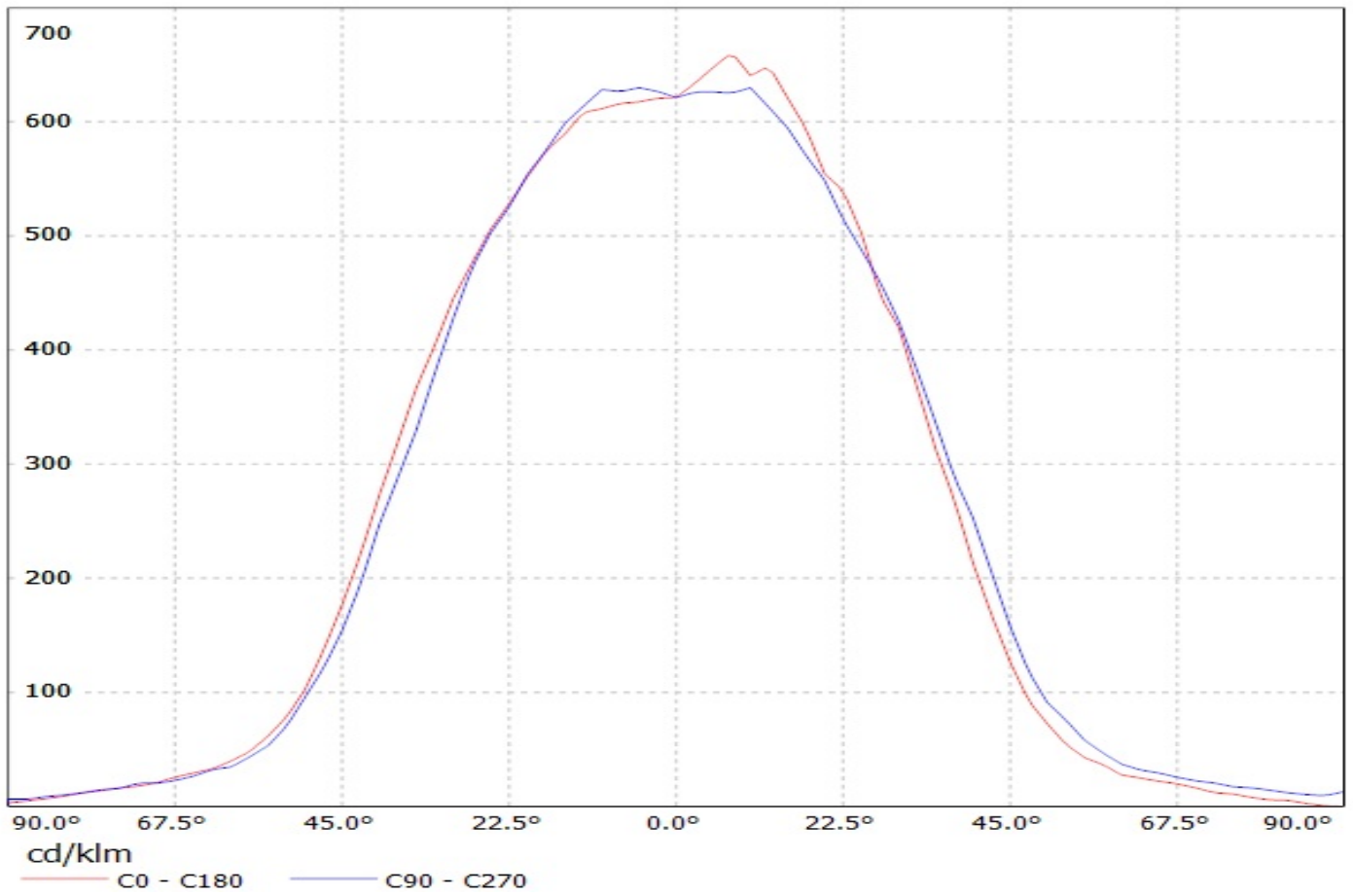

Luminaire: Ledil Oy FA11826_Tina3-WWW-XP-G FA11826_Tina3-WWW-XP-G
Lamps: 1 x Cree XP-G white

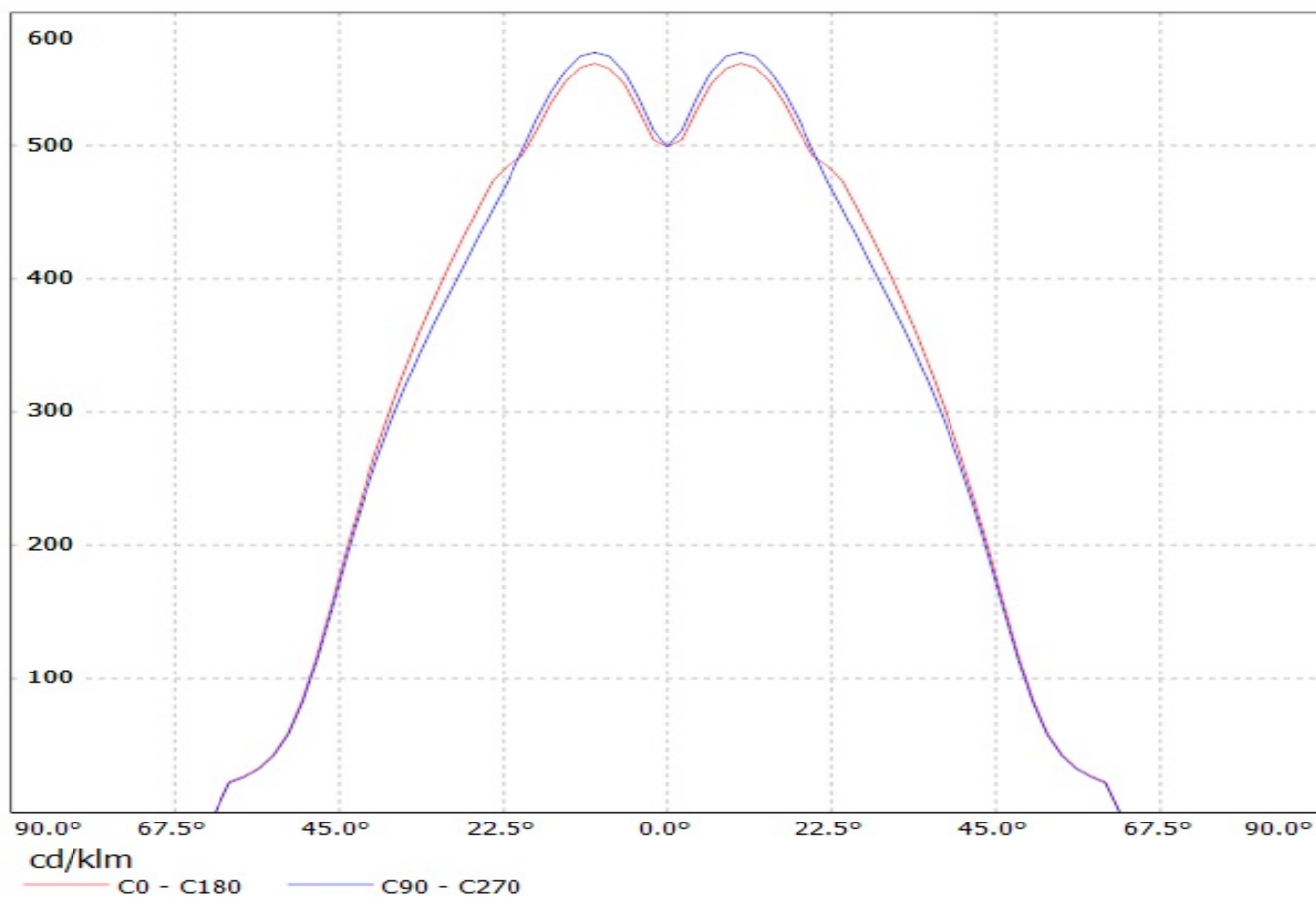

Ledil FA11824_Tina3-W-XP-G FA11824_Tina3-W-XP-G / LDC (Polar)

Luminaire: Ledil FA11824_Tina3-W-XP-G FA11824_Tina3-W-XP-G

Lamps: 1 x LED Module

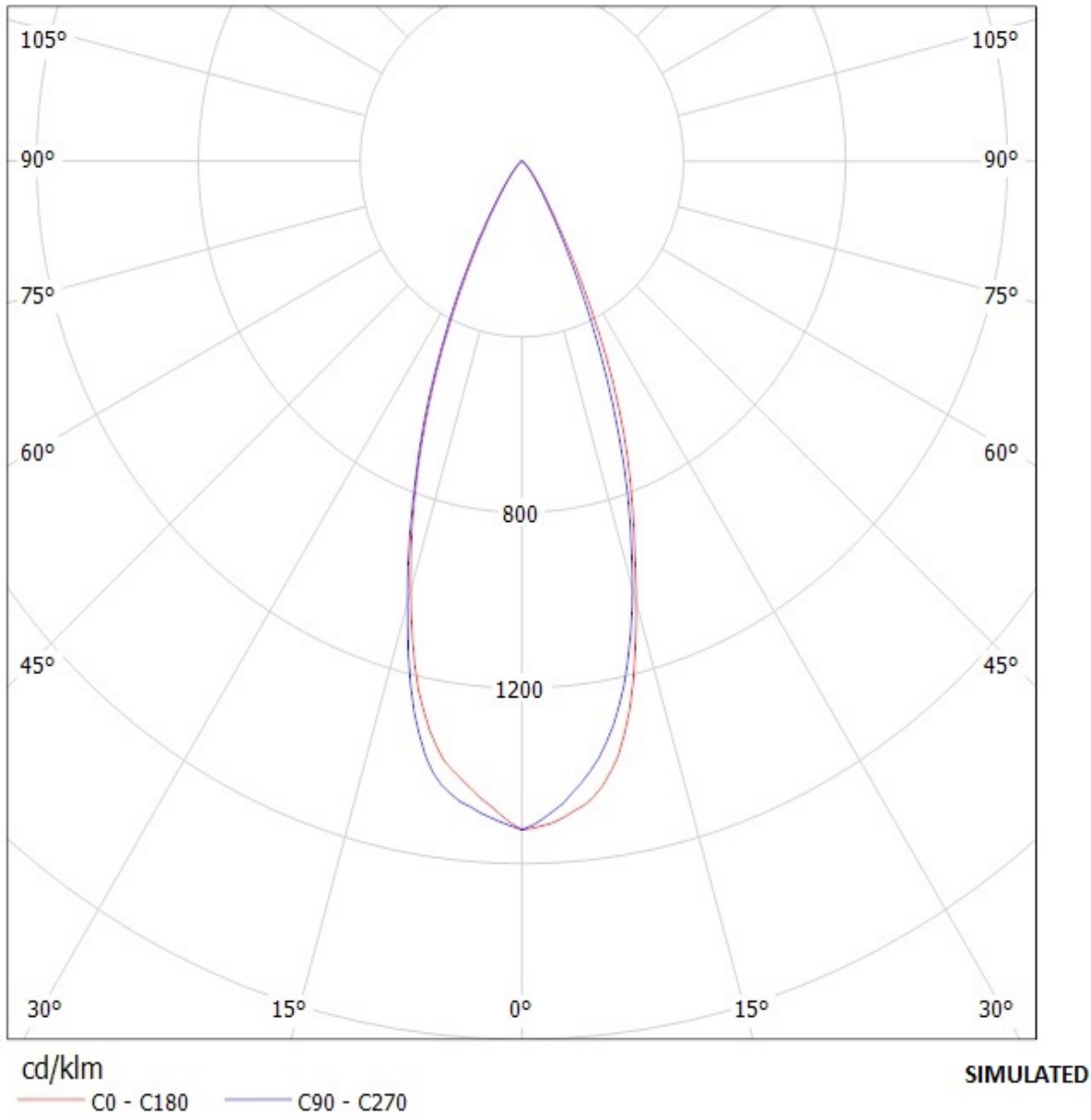

Luminaire: Ledil Oy CA13043_TINA3-W (Cree XP-G 87lm @ 250mA) Efficiency=93%
Lamps: 1 x Cree XP-G 87lm @ 250mA

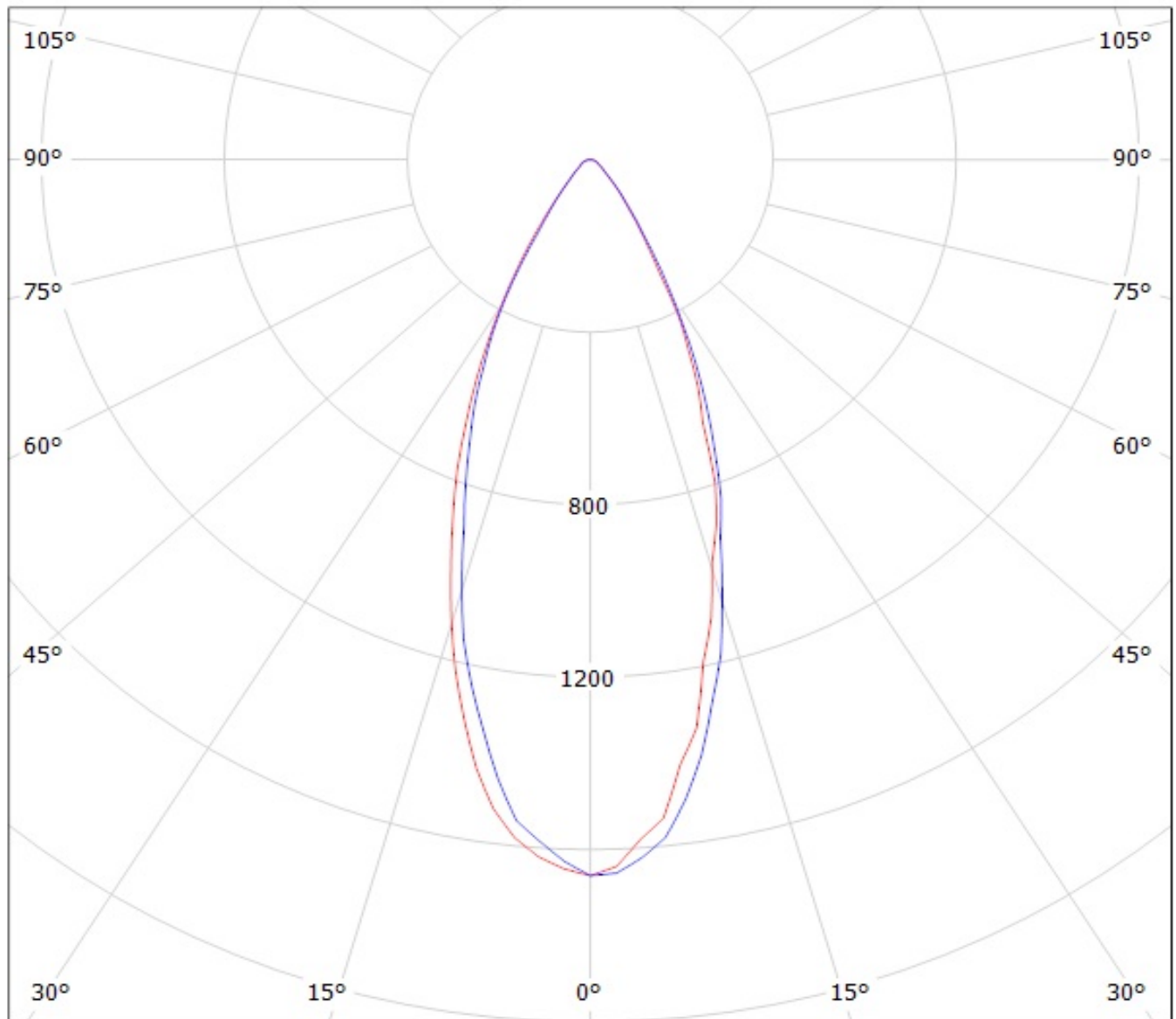

cd/klm

— C0 - C180

— C90 - C270

Ledil FA11825_Tina3-WW-XP-G FA11825_Tina3-WW-XP-G / LDC (Polar)

Luminaire: Ledil FA11825_Tina3-WW-XP-G FA11825_Tina3-WW-XP-G

Lamps: 1 x LED Module

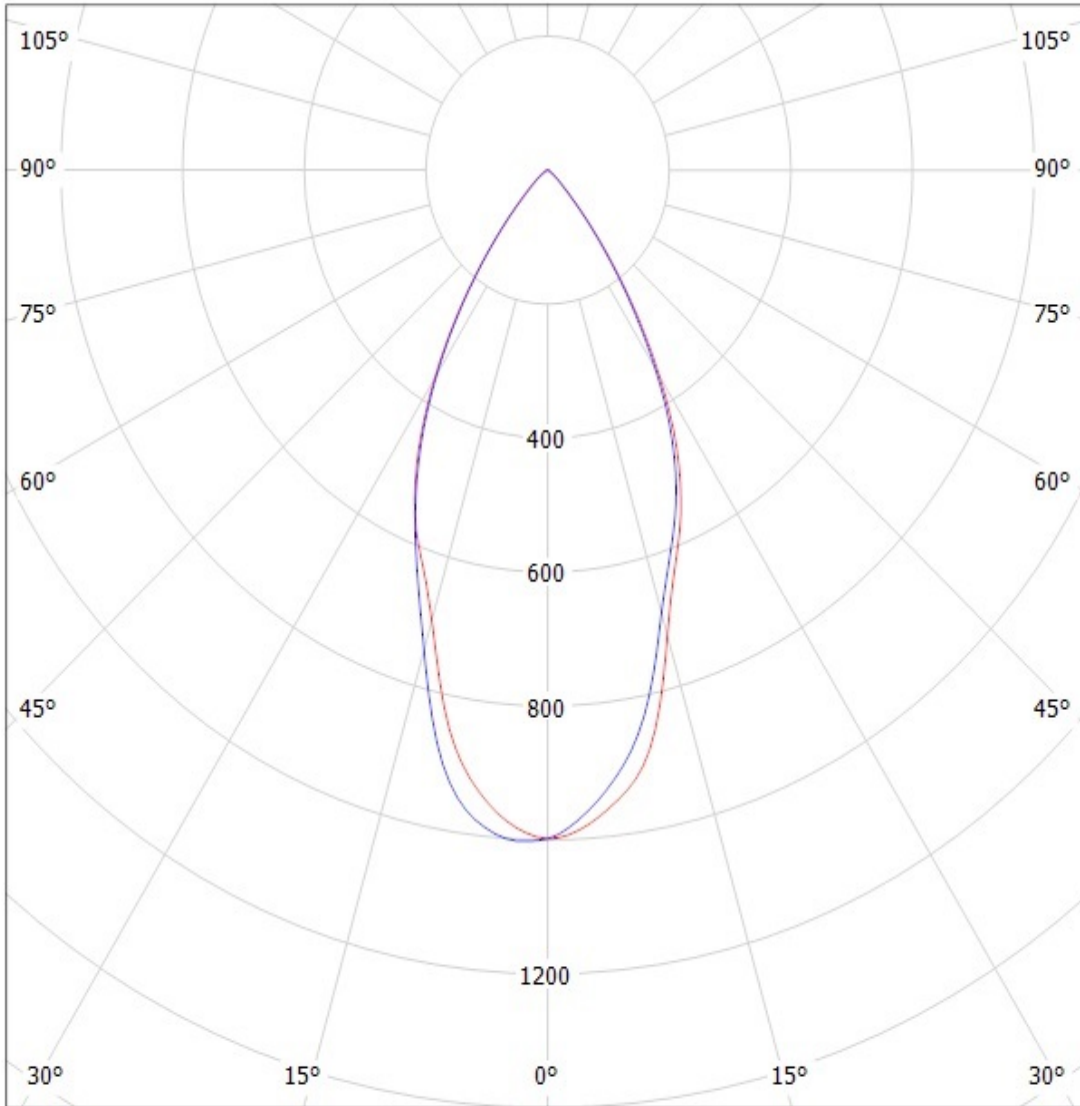

cd/klm

— C0 - C180 — C90 - C270

SIMULATED

Luminaire: Ledil Oy CA12426_TINA3-W (Cree XP-G 68lm @ 250mA) Efficiency=90%
Lamps: 1 x Cree XP-G 68lm @ 250mA

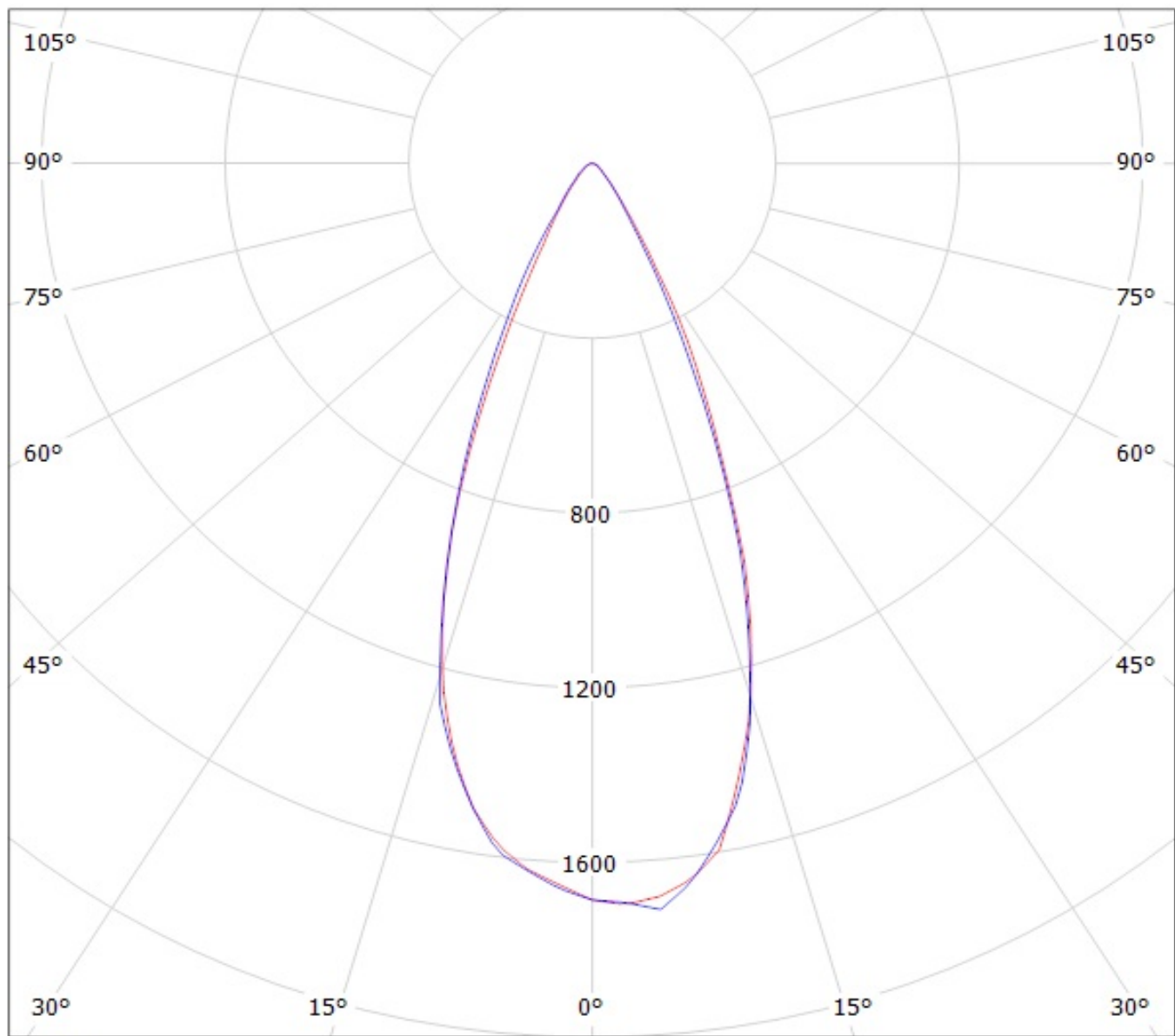

cd/klm
— C0 - C180 — C90 - C270

Luminaire: Ledil Oy CA13044_TINA3-00 (Cree XP-G 87lm @ 250mA) Efficiency=93%
Lamps: 1 x Cree XP-G 87lm @ 250mA

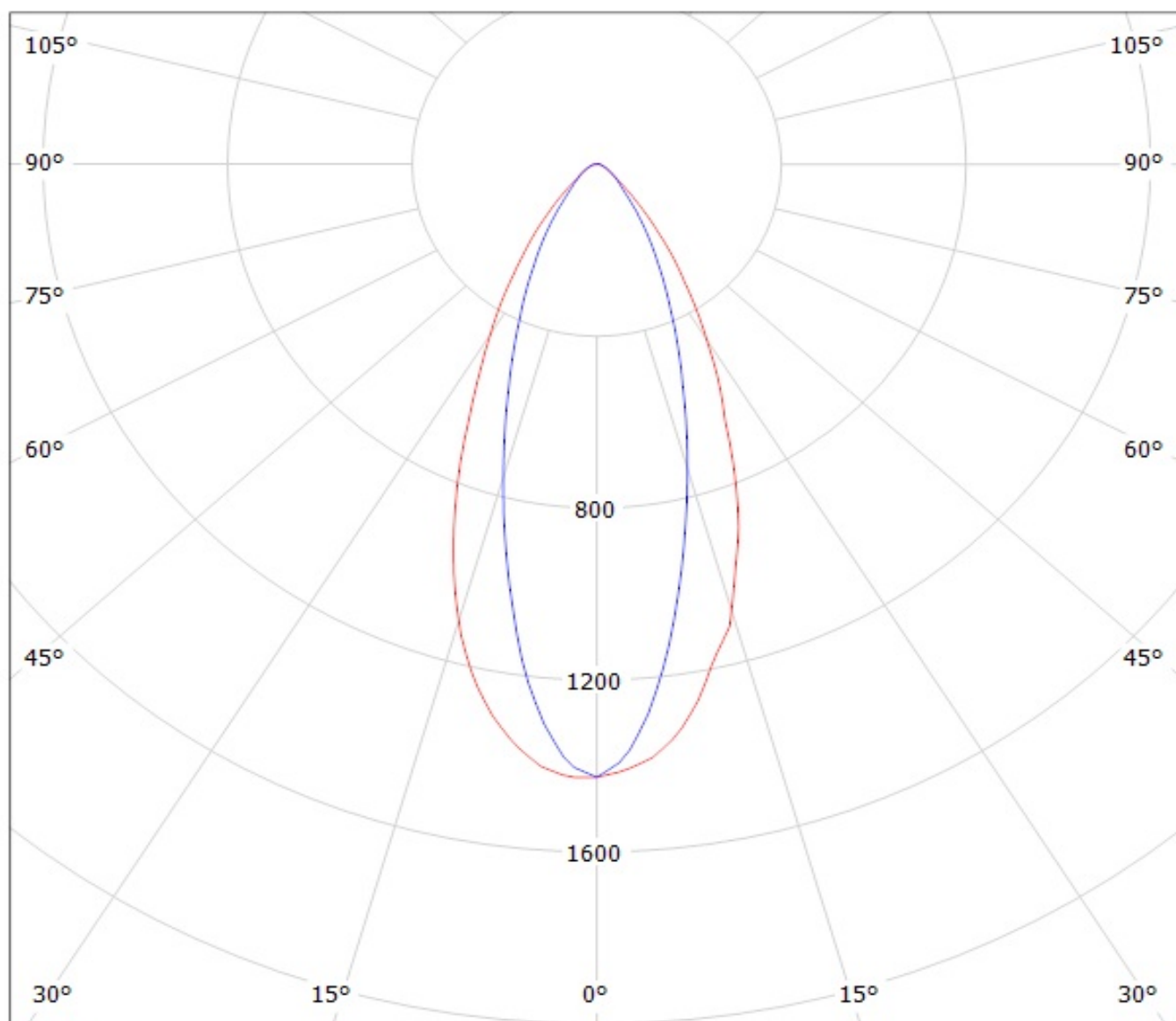

cd/klm

— C0 - C180

— C90 - C270

Luminaire: Ledil Oy CA12892_TINA3-WW (Cree XP-G 87lm @ 250mA) Efficiency=93%
Lamps: 1 x Cree XP-G 87lm @ 250mA

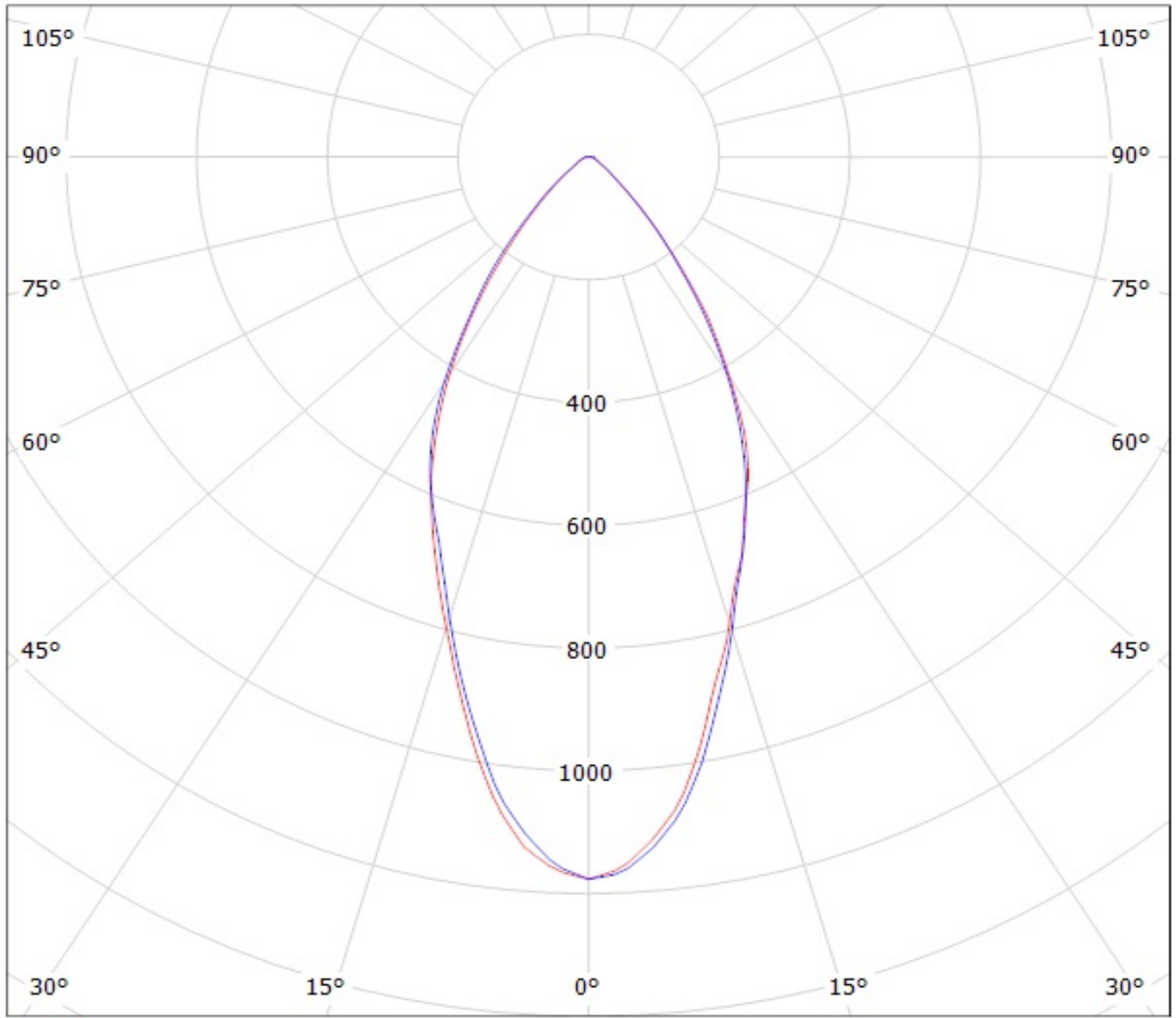

cd/klm

— C0 - C180 — C90 - C270

Luminaire: LEDIL OY FA11870-Tina3-OO (XP-G) Efficiency=93%
Lamps: 1 x Cree XP-G (82lm@250mA)

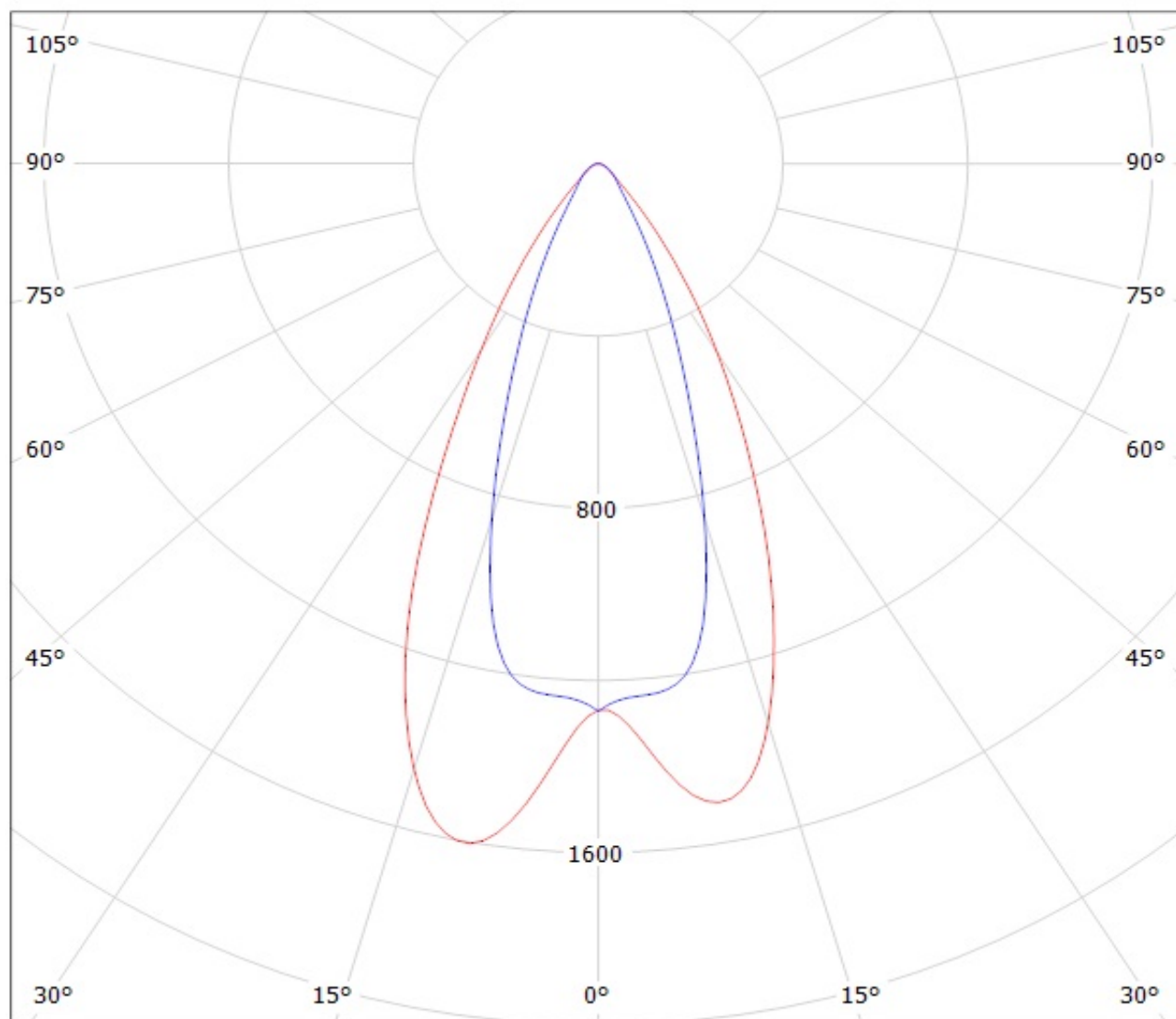

cd/klm

— C0 - C180

— C90 - C270

Luminaire: Ledil Oy CA12429_TINA3-00 (Cree XP-G 68lm @ 250mA) Efficiency=90%
Lamps: 1 x Cree XP-G 68lm @ 250mA

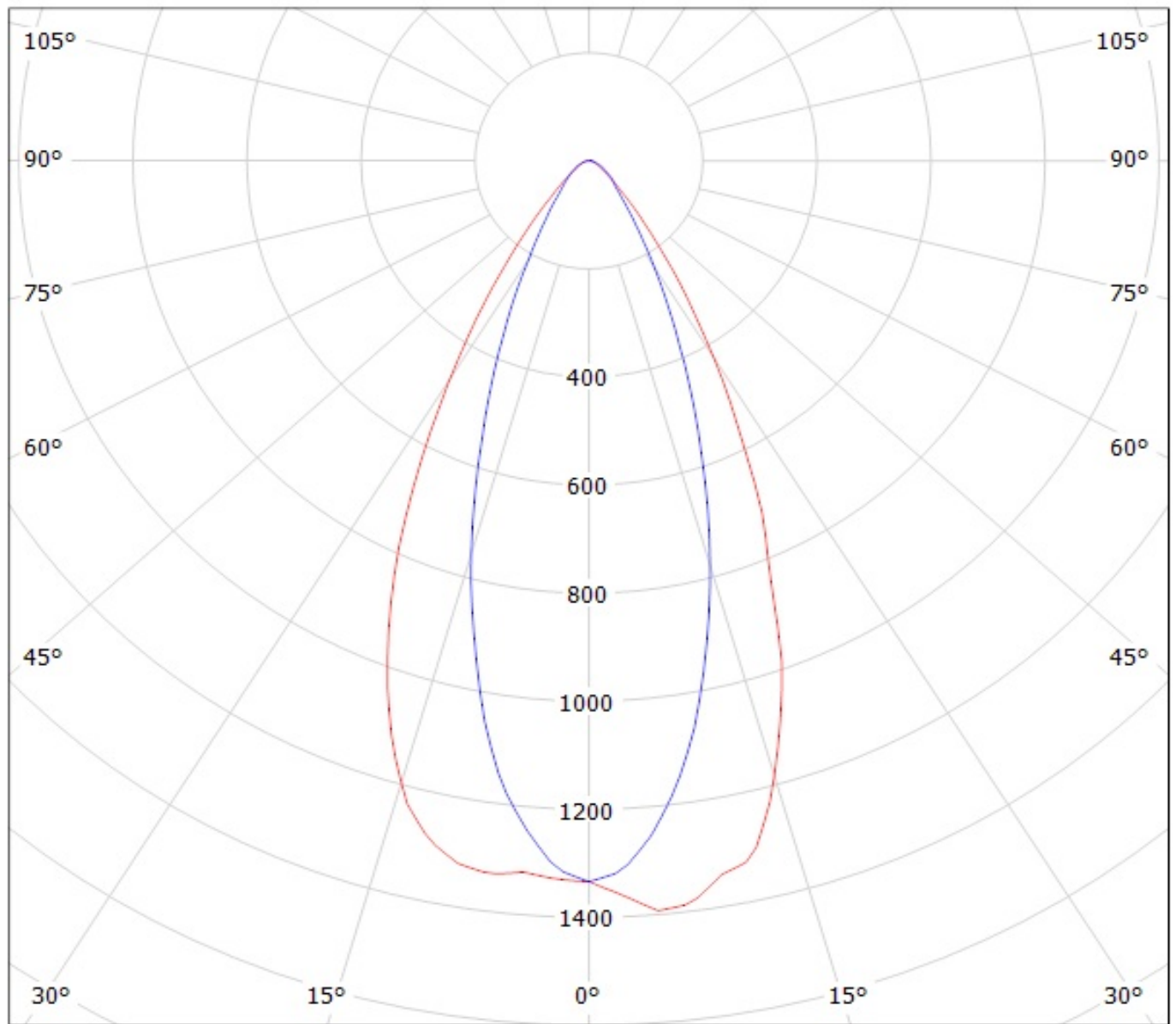

cd/klm

— C0 - C180 — C90 - C270

Luminaire: Ledil Oy CA12427_TINA3-WW (Cree XP-G 68lm @ 250mA) Efficiency=89%
Lamps: 1 x Cree XP-G 68lm @ 250mA

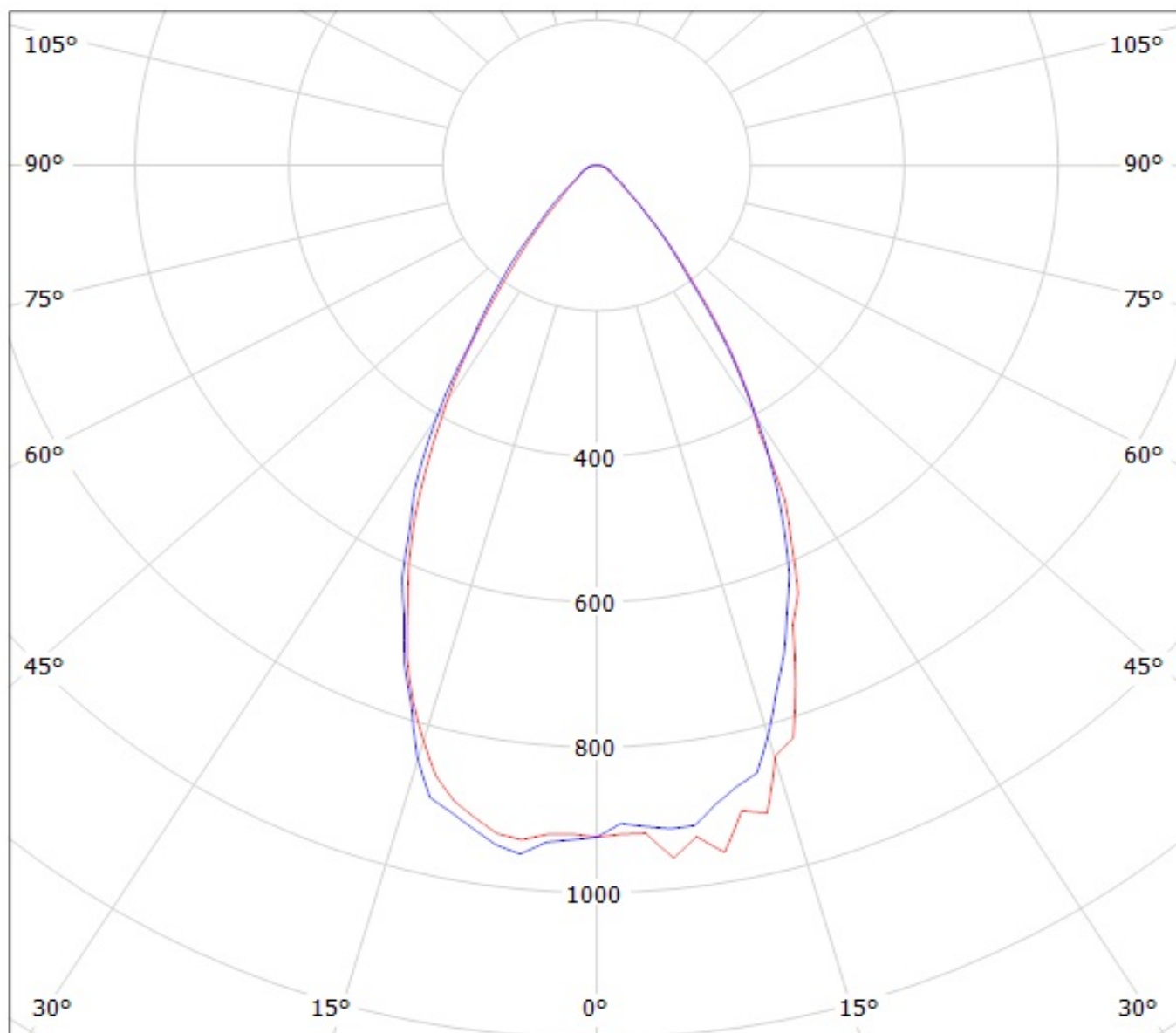

cd/klm

— C0 - C180 — C90 - C270

Luminaire: Ledil Oy CA13045_TINA3-WWW (Cree XP-G 87lm @ 250mA) Efficiency=92%
Lamps: 1 x Cree XP-G 87lm @ 250mA

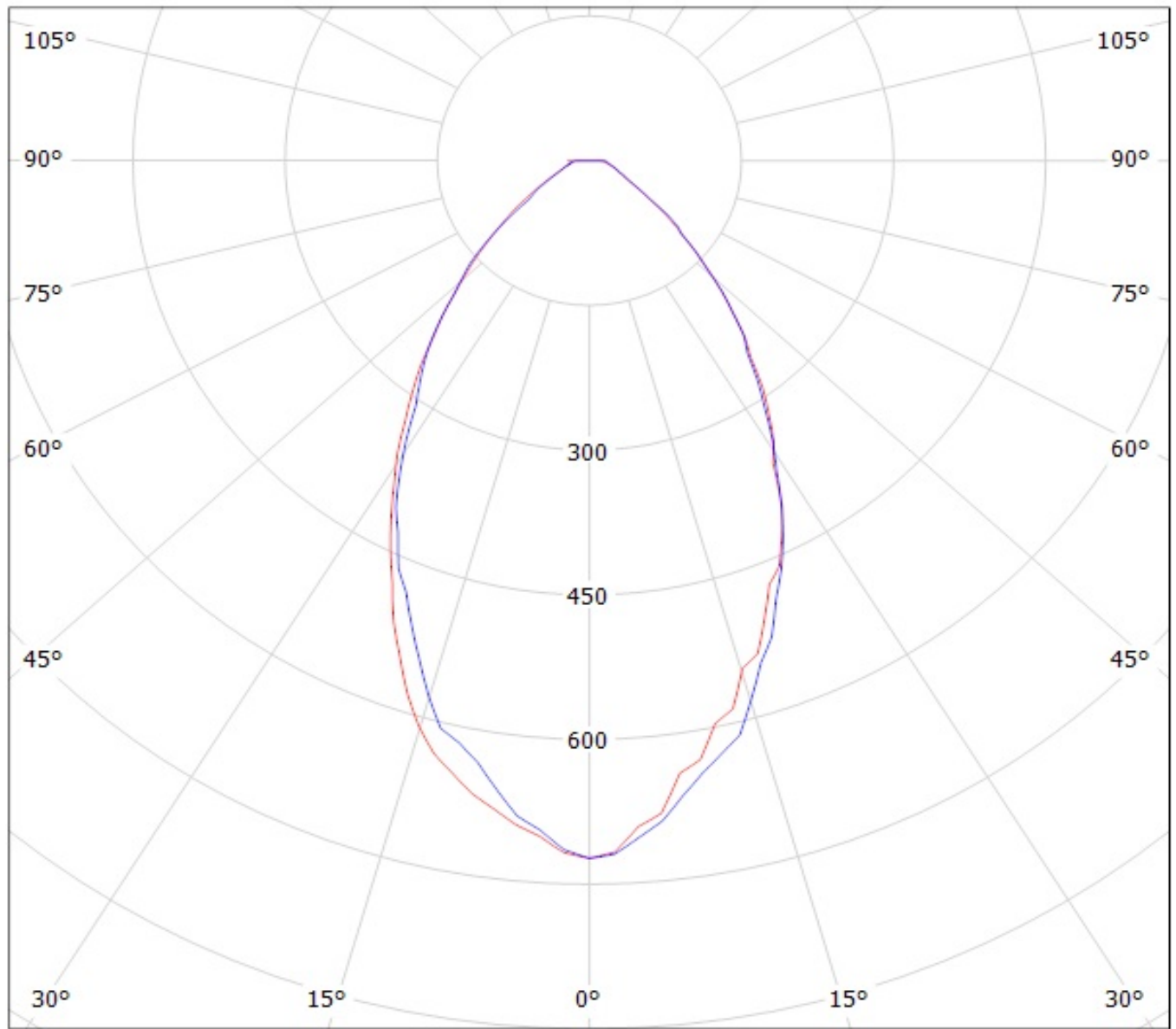

cd/klm

— C0 - C180 — C90 - C270

Luminaire: Ledil Oy CA12428_TINA3-WWW (Osram Square EC 68lm @ 250mA) Efficiency=87%
Lamps: 1 x Osram Square EC 68lm @ 250mA

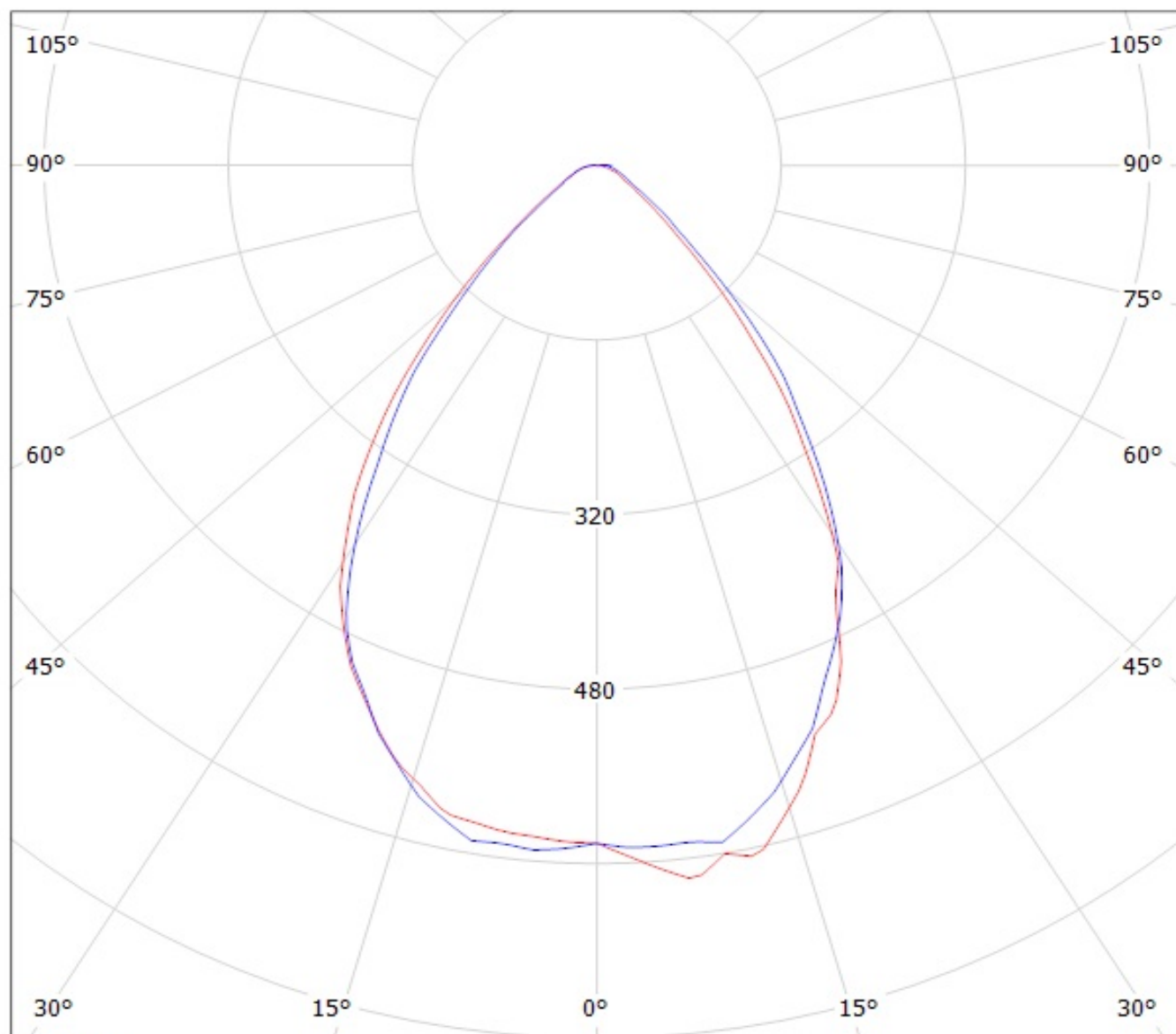

cd/klm

— C0 - C180

— C90 - C270

Luminaire: Ledil Oy FA11826_Tina3-WWW-XP-G FA11826_Tina3-WWW-XP-G
Lamps: 1 x Cree XP-G white

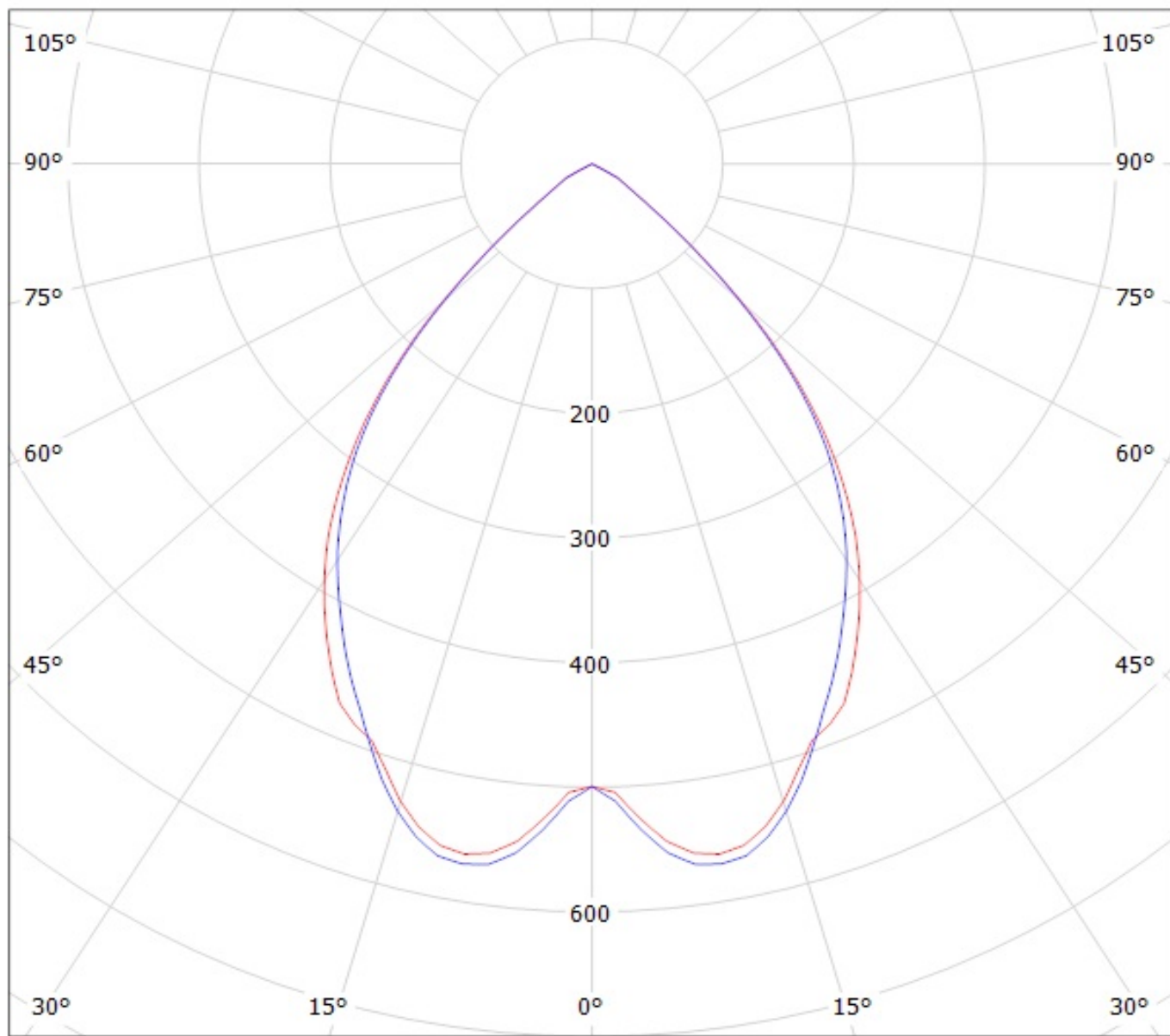

cd/klm

— C0 - C180 — C90 - C270