

LP2954/LP2954A 5V and Adjustable Micropower Low-Dropout Voltage Regulators

 Check for Samples: [LP2954](#), [LP2954A](#)

FEATURES

- 5V Output within 1.2% Over Temperature (A Grade)
- Adjustable 1.23 to 29V Output Voltage Available (LP2954IM and LP2954AIM)
- Ensured 250 mA Output Current
- Extremely Low Quiescent Current
- Low Dropout Voltage
- Reverse Battery Protection
- Extremely Tight Line and Load Regulation
- Very Low Temperature Coefficient
- Current and Thermal Limiting
- Pin Compatible with LM2940 and LM340 (5V Version Only)
- Adjustable Version Adds Error Flag to Warn of Output Drop and a Logic-Controlled Shutdown

APPLICATIONS

- High-Efficiency Linear Regulator
- Low Dropout Battery-Powered Regulator

Package Outline and Ordering Information

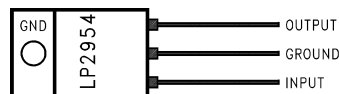

Figure 1. TO-220 3-Lead Plastic Package (Front View)

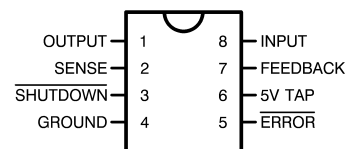

Figure 2. SO-8 Small Outline Surface Mount (Top View)

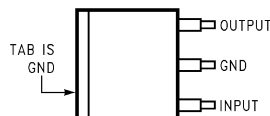

Figure 3. TO-263 3-Lead Plastic Surface-Mount Package (Top View)



Figure 4. TO-263 3-Lead Plastic Surface-Mount Package (Side View)



These devices have limited built-in ESD protection. The leads should be shorted together or the device placed in conductive foam during storage or handling to prevent electrostatic damage to the MOS gates.



Please be aware that an important notice concerning availability, standard warranty, and use in critical applications of Texas Instruments semiconductor products and disclaimers thereto appears at the end of this data sheet.

All trademarks are the property of their respective owners.

Absolute Maximum Ratings⁽¹⁾⁽²⁾

Operating Junction Temperature Range	LP2954AI/LP2954I	-40°C to +125°C
Storage Temperature Range		-65°C to +150°C
Lead Temperature (Soldering, 5 seconds)		260°C
Power Dissipation ⁽³⁾		Internally Limited
Input Supply Voltage		-20V to +30V
ESD Rating ⁽⁴⁾		2 kV

- (1) Absolute maximum ratings indicate limits beyond which damage to the component may occur. Electrical specifications do not apply when operating the device outside of its rated operating conditions.
- (2) If Military/Aerospace specified devices are required, please contact the Texas Instruments Sales Office/Distributors for availability and specifications.
- (3) The maximum allowable power dissipation is a function of the maximum junction temperature, T_J (MAX), the junction-to-ambient thermal resistance, θ_{J-A} , and the ambient temperature, T_A . The maximum allowable power dissipation at any ambient temperature is calculated using:

$$P(\text{MAX}) = \frac{T_J(\text{MAX}) - T_A}{\theta_{J-A}}$$
 Exceeding the maximum allowable power dissipation will result in excessive die temperature, and the regulator will go into thermal shutdown. The junction-to-ambient thermal resistance of the TO-220 (without heatsink) is 60°C/W, 73°C/W for the DDPAK/TO-263, and 160°C/W for the SOIC-8. If the DDPAK/TO-263 package is used, the thermal resistance can be reduced by increasing the P.C. board copper area thermally connected to the package: Using 0.5 square inches of copper area, θ_{JA} is 50°C/W; with 1 square inch of copper area, θ_{JA} is 37°C/W; and with 1.6 or more square inches of copper area, θ_{JA} is 32°C/W. The junction-to-case thermal resistance is 3°C/W. If an external heatsink is used, the effective junction-to-ambient thermal resistance is the sum of the junction-to-case resistance (3°C/W), the specified thermal resistance of the heatsink selected, and the thermal resistance of the interface between the heatsink and the LP2954. Some typical values are listed for interface materials used with TO-220:
- (4) Human body model, 200pF discharged through 1.5kΩ.

Electrical Characteristics

Limits in standard typeface are for $T_J = 25^\circ\text{C}$, **bold typeface applies over the -40°C to $+125^\circ\text{C}$ temperature range**. Limits are specified by production testing or correlation techniques using standard Statistical Quality Control (SQC) methods. Unless otherwise noted: $V_{IN} = 6\text{V}$, $I_L = 1\text{ mA}$, $C_L = 2.2\ \mu\text{F}$.

Symbol	Parameter	Conditions	Typical	2954AI		2954I		Units
				Min	Max	Min	Max	
V_O	Output Voltage ⁽¹⁾		5.0	4.975	5.025	4.950	5.050	V
		$1\text{ mA} \leq I_L \leq 250\text{ mA}$	5.0	4.930	5.070	4.880	5.120	
$\frac{\Delta V_O}{\Delta T}$	Output Voltage Temp. Coefficient ⁽¹⁾	See ⁽²⁾	20		100		150	ppm/°C
$\frac{\Delta V_O}{V_O}$	Line Regulation	$V_{IN} = 6\text{V to }30\text{V}$	0.03		0.10		0.20	%
$\frac{\Delta V_O}{V_O}$	Load Regulation	$I_L = 1\text{ to }250\text{ mA}$ $I_L = 0.1\text{ to }1\text{ mA}$ ⁽³⁾	0.04		0.16		0.20	%
$V_{IN}-V_O$	Dropout Voltage ⁽⁴⁾	$I_L = 1\text{ mA}$	60		100		100	mV
		$I_L = 50\text{ mA}$	240		300		300	
		$I_L = 100\text{ mA}$	310		400		400	
		$I_L = 250\text{ mA}$	470		600		600	
I_{GND}	Ground Pin Current ⁽⁵⁾	$I_L = 1\text{ mA}$	90		150		150	μA
		$I_L = 50\text{ mA}$	1.1		2		2	
		$I_L = 100\text{ mA}$	4.5		6		6	mA
		$I_L = 250\text{ mA}$	21		28		28	
I_{GND}	Ground Pin Current at Dropout ⁽⁵⁾	$V_{IN} = 4.5\text{V}$	120		170		170	μA
I_{LIMIT}	Current Limit	$V_{OUT} = 0\text{V}$	380		500		500	mA
$\frac{\Delta V_O}{\Delta P_d}$	Thermal Regulation	See ⁽⁶⁾	0.05		0.2		0.2	%/W
e_n	Output Noise Voltage (10 Hz to 100 kHz) $I_L = 100\text{ mA}$	$C_L = 2.2\ \mu\text{F}$	400					$\mu\text{V RMS}$
		$C_L = 33\ \mu\text{F}$	260					
		$C_L = 33\ \mu\text{F}$ ⁽⁷⁾	80					

- (1) When used in dual-supply systems where the regulator load is returned to a negative supply, the output voltage must be diode-clamped to ground.
- (2) Output voltage temperature coefficient is defined as the worst case voltage change divided by the total temperature range.
- (3) Regulation is measured at constant junction temperature using low duty cycle pulse testing. Parts are tested separately for load regulation in the load ranges 0.1 mA–1 mA and 1 mA–250 mA. Changes in output voltage due to heating effects are covered by the thermal regulation specification.
- (4) Dropout voltage is defined as the input to output differential at which the output voltage drops 100 mV below the value measured with a 1V differential.
- (5) Ground pin current is the regulator quiescent current. The total current drawn from the source is the sum of the load current plus the ground pin current.
- (6) Thermal regulation is defined as the change in output voltage at a time T after a change in power dissipation is applied, excluding load or line regulation effects. Specifications are for 200 mA load pulse at $V_{IN} = 20\text{V}$ (3W pulse) for $T = 10\text{ ms}$.
- (7) Connect a 0.1 μF capacitor from the output to the feedback pin.

Electrical Characteristics (continued)

Limits in standard typeface are for $T_J = 25^\circ\text{C}$, **bold typeface applies over the -40°C to $+125^\circ\text{C}$ temperature range**. Limits are specified by production testing or correlation techniques using standard Statistical Quality Control (SQC) methods. Unless otherwise noted: $V_{IN} = 6\text{V}$, $I_L = 1\text{ mA}$, $C_L = 2.2\ \mu\text{F}$.

Symbol	Parameter	Conditions	Typical	2954AI		2954I		Units
				Min	Max	Min	Max	
Additional Specifications for the Adjustable Device (LP2954AIM and LP2954IM)								
V_{REF}	Reference Voltage	See ⁽⁸⁾	1.230	1.215 1.205	1.245 1.255	1.205 1.190	1.255 1.270	V
$\frac{\Delta V_{REF}}{V_{REF}}$	Reference Voltage Line Regulation	$V_{IN}=2.5\text{V}$ to $V_O(\text{NOM})+1\text{V}$	0.03		0.1		0.2	%
		$V_{IN}=2.5\text{V}$ to $V_O(\text{NOM})+1\text{V}$ to 30V ⁽⁹⁾			0.2		0.4	%
$\frac{\Delta V_{REF}}{\Delta T}$	Reference Voltage Temperature Coefficient	See ⁽²⁾	20					ppm/°C
$I_B(\text{FB})$	Feedback Pin Bias Current		20		40 60		40 60	nA
I_{GND}	Ground Pin Current at Shutdown ⁽⁵⁾	$V_{SHUTDOWN} \leq 1.1\text{V}$	105		140		140	μA
$I_O(\text{SINK})$	Output "OFF" Pulldown Current	See ⁽¹⁰⁾		30 20		30 20		mA
Dropout Detection Comparator								
I_{OH}	Output "HIGH" Leakage Current	$V_{OH}=30\text{V}$	0.01		1 2		1 2	μA
V_{OL}	Output "LOW" Voltage	$V_{IN}=V_O(\text{NOM})-0.5\text{V}$ $I_O(\text{COMP})=400\ \mu\text{A}$	150		250 400		250 400	mV
$V_{THR}(\text{MAX})$	Upper Threshold Voltage	See ⁽¹¹⁾	-60	-80 -95	-35 -25	-80 -95	-35 -25	mV
$V_{THR}(\text{MIN})$	Lower Threshold Voltage	See ⁽¹²⁾	-85	-110 -160	-55 -40	-110 -160	-55 -40	mV
HYST	Hysteresis	See ⁽¹²⁾	15					mV
Shutdown Input								
V_{OS}	Input Offset Voltage	(Referred to V_{REF})	± 3	-7.5 -10	7.5 10	-7.5 -10	7.5 10	mV
HYST	Hysteresis		6					mV
I_B	Input Bias Current	$V_{IN}(\text{S/D})=0\text{V}$ to 5V	10	-30 -50	30 50	-30 -50	30 50	nA

(8) $V_{REF} \leq V_{OUT} \leq (V_{IN} - 1\text{V})$, $2.3\text{V} \leq V_{IN} \leq 30\text{V}$, $100\ \mu\text{A} \leq I_L \leq 250\text{mA}$.

(9) Two separate tests are performed, one covering $V_{IN}=2.5\text{V}$ to $V_O(\text{NOM})+1\text{V}$ and the other test for $V_{IN}=2.5\text{V}$ to $V_O(\text{NOM})+1\text{V}$ to 30V .

(10) $V_{SHUTDOWN} \leq 1.1\text{V}$, $V_{OUT}=V_O(\text{NOM})$.

(11) Comparator thresholds are expressed in terms of a voltage differential at the Feedback terminal below the nominal reference voltage measured at $V_{IN}=V_O(\text{NOM})+1\text{V}$. To express these thresholds in terms of output voltage change, multiply by the Error amplifier gain, which is $V_{OUT}/V_{REF}=(R1+R2)/R2$.

(12) Comparator thresholds are expressed in terms of a voltage differential at the Feedback terminal below the nominal reference voltage measured at $V_{IN}=V_O(\text{NOM})+1\text{V}$. To express these thresholds in terms of output voltage change, multiply by the Error amplifier gain, which is $V_{OUT}/V_{REF}=(R1+R2)/R2$.

Table 1. Typical Values of Case-to-Heatsink Thermal Resistance (°C/W) (Data from AAVID Eng.)

Silicone grease	1.0
Dry interface	1.3
Mica with grease	1.4

Table 2. Typical Values of Case-to-Heatsink Thermal Resistance (°C/W) (Data from Thermalloy)

Thermasil III	1.3
Thermasil II	1.5
Thermalfilm (0.002) with grease	2.2

Typical Performance Characteristics

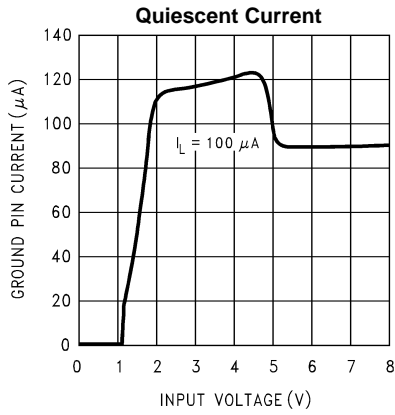

Figure 5.

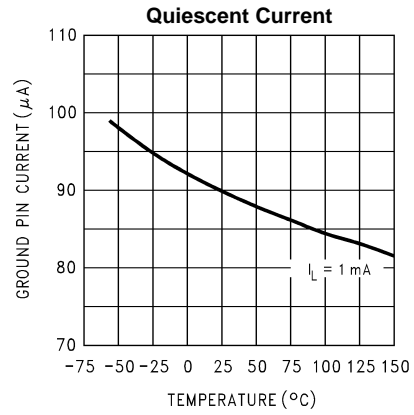

Figure 6.

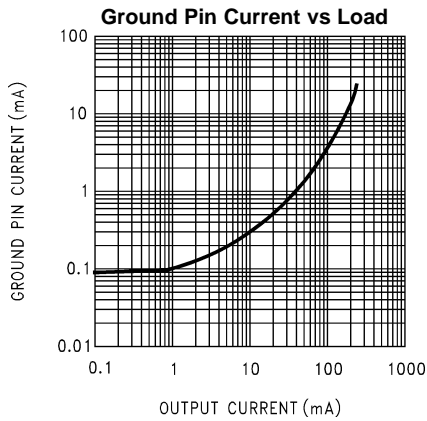

Figure 7.

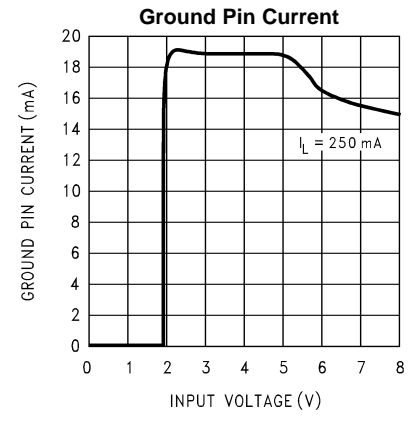

Figure 8.

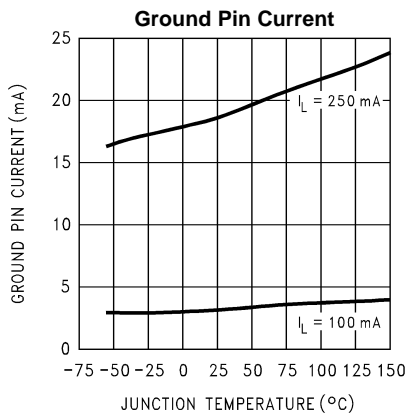

Figure 9.

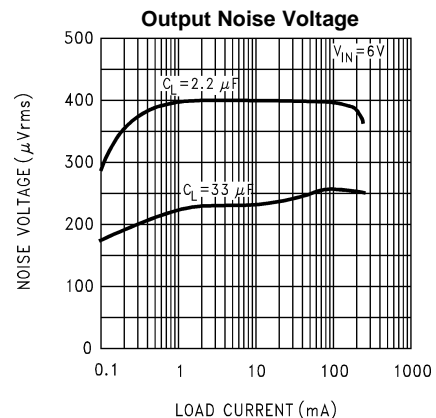

Figure 10.

Typical Performance Characteristics (continued)

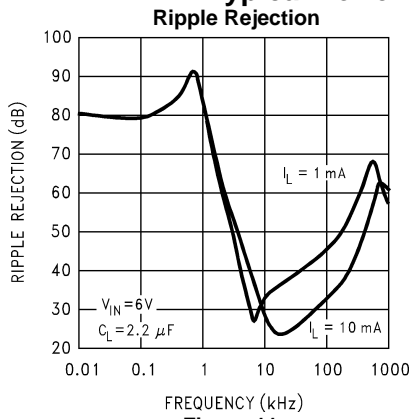

Figure 11.

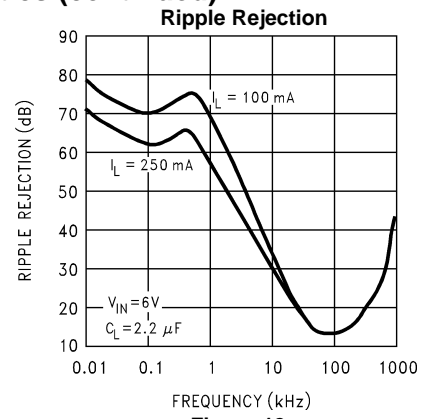

Figure 12.

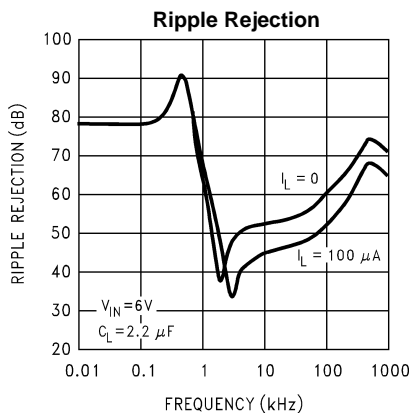

Figure 13.

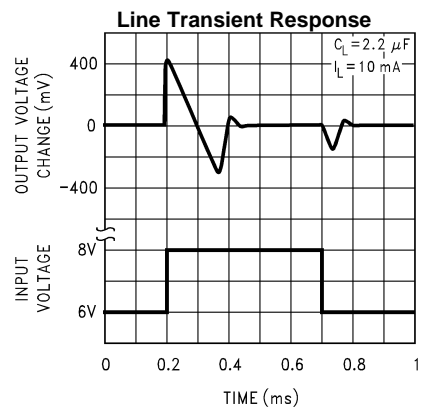

Figure 14.

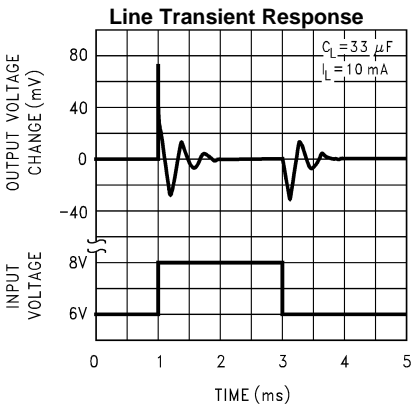

Figure 15.

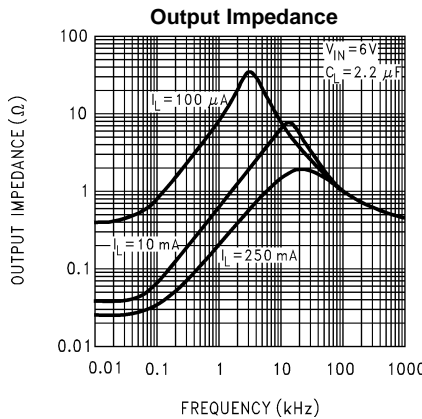

Figure 16.

Typical Performance Characteristics (continued)

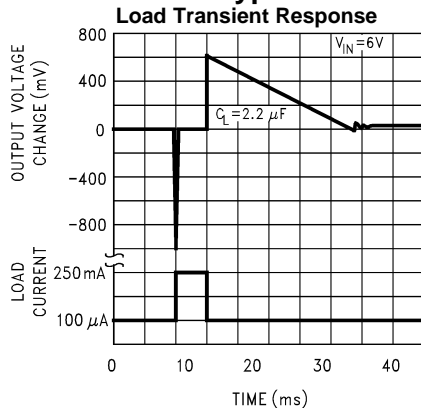

Figure 17.

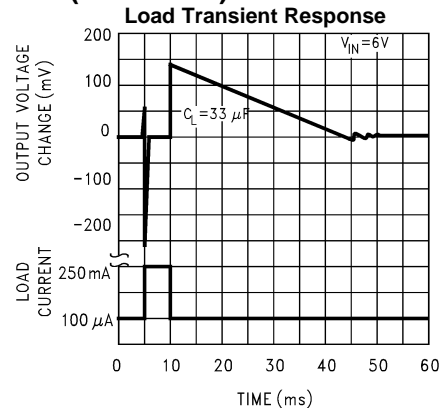

Figure 18.

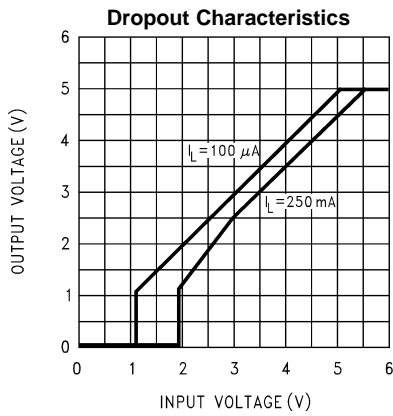

Figure 19.

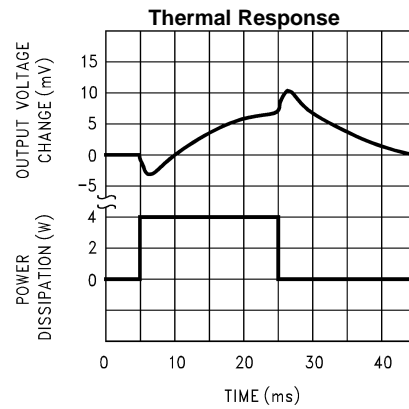

Figure 20.

Typical Performance Characteristics (continued)

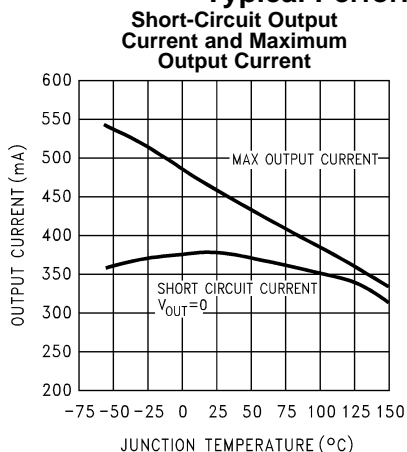

Figure 21.

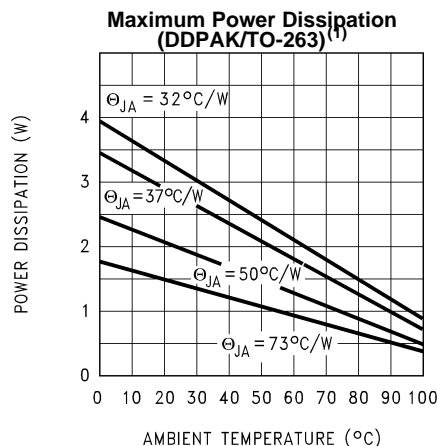

Figure 22.

- (1) The maximum allowable power dissipation is a function of the maximum junction temperature, T_J (MAX), the junction-to-ambient thermal resistance, θ_{J-A} , and the ambient temperature, T_A . The maximum allowable power dissipation at any ambient temperature is calculated using:

$$P(\text{MAX}) = \frac{T_J(\text{MAX}) - T_A}{\theta_{J-A}}$$

Exceeding the maximum allowable power dissipation will result in excessive die temperature, and the regulator will go into thermal shutdown. The junction-to-ambient thermal resistance of the TO-220 (without heatsink) is 60°C/W, 73°C/W for the DDPAK/TO-263, and 160°C/W for the SOIC-8. If the DDPAK/TO-263 package is used, the thermal resistance can be reduced by increasing the P.C. board copper area thermally connected to the package: Using 0.5 square inches of copper area, θ_{JA} is 50°C/W; with 1 square inch of copper area, θ_{JA} is 37°C/W; and with 1.6 or more square inches of copper area, θ_{JA} is 32°C/W. The junction-to-case thermal resistance is 3°C/W. If an external heatsink is used, the effective junction-to-ambient thermal resistance is the sum of the junction-to-case resistance (3°C/W), the specified thermal resistance of the heatsink selected, and the thermal resistance of the interface between the heatsink and the LP2954. Some typical values are listed for interface materials used with TO-220:

APPLICATION HINTS

EXTERNAL CAPACITORS

A 2.2 μF (or greater) capacitor is **required** between the output pin and the ground to assure stability (refer to [Figure 23](#)). Without this capacitor, the part may oscillate. Most types of tantalum or aluminum electrolytics will work here. Film types will work, but are more expensive. Many aluminum electrolytics contain electrolytes which freeze at -30°C , which requires the use of solid tantalums below -25°C . The important parameters of the capacitor are an ESR of about 5Ω or less and a resonant frequency above 500 kHz (the ESR may increase by a factor of **20** or **30** as the temperature is reduced from 25°C to -30°C). The value of this capacitor may be increased without limit. At lower values of output current, less output capacitance is required for stability. The capacitor can be reduced to 0.68 μF for currents below 10 mA or 0.22 μF for currents below 1 mA.

A 1 μF capacitor should be placed from the input pin to ground if there is more than 10 inches of wire between the input and the AC filter capacitor or if a battery input is used.

Programming the output for voltages below 5V runs the error amplifier at lower gains requiring more output capacitance for stability. At 3.3V output, a minimum of 4.7 μF is required. For the worst case condition of 1.23V output and 250 mA of load current, a 6.8 μF (or larger) capacitor should be used.

Stray capacitance to the Feedback terminal can cause instability. This problem is most likely to appear when using high value external resistors to set the output voltage. Adding a 100 pF capacitor between the Output and Feedback pins and increasing the output capacitance to 6.8 μF (or greater) will cure the problem.

MINIMUM LOAD

When setting the output voltage using an external resistive divider, a minimum current of 1 μA is recommended through the resistors to provide a minimum load.

It should be noted that a minimum load current is specified in several of the electrical characteristic test conditions, so this value must be used to obtain correlation on these tested limits. The part is parametrically tested down to 100 μA , but is functional with no load.

DROPOUT VOLTAGE

The dropout voltage of the regulator is defined as the minimum input-to-output voltage differential required for the output voltage to stay within 100 mV of the output voltage measured with a 1V differential. The dropout voltages for various values of load current are listed under [Electrical Characteristics](#).

If the regulator is powered from a rectified AC source with a capacitive filter, the minimum AC line voltage and maximum load current must be used to calculate the minimum voltage at the input of the regulator. The minimum input voltage, **including AC ripple on the filter capacitor**, must not drop below the voltage required to keep the LP2954 in regulation. It is also advisable to verify operating at **minimum** operating ambient temperature, since the increasing ESR of the filter capacitor makes this a worst-case test for dropout voltage due to increased ripple amplitude.

HEATSINK REQUIREMENTS

A heatsink may be required with the LP2954 depending on the maximum power dissipation and maximum ambient temperature of the application. Under all possible operating conditions, the junction temperature must be within the range specified under Absolute Maximum Ratings.

To determine if a heatsink is required, the maximum power dissipated by the regulator, $P(\text{max})$, must be calculated. It is important to remember that if the regulator is powered from a transformer connected to the AC line, the **maximum specified AC input voltage** must be used (since this produces the maximum DC input voltage to the regulator). [Figure 23](#) shows the voltages and currents which are present in the circuit. The formula for calculating the power dissipated in the regulator is also shown in [Figure 23](#).

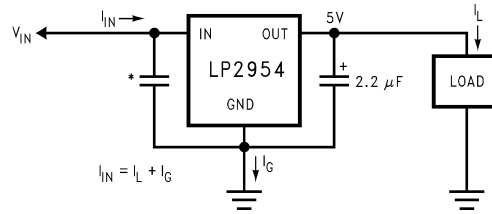

*See EXTERNAL CAPACITORS

$$P_{\text{Total}} = (V_{\text{IN}} - 5) I_L + (V_{\text{IN}}) I_G$$

Figure 23. Basic 5V Regulator Circuit

The next parameter which must be calculated is the maximum allowable temperature rise, $T_R(\text{max})$. This is calculated by using the formula:

$$T_R(\text{max}) = T_J(\text{max}) - T_A(\text{max})$$

where

- $T_J(\text{max})$ is the maximum allowable junction temperature
- $T_A(\text{max})$ is the maximum ambient temperature

Using the calculated values for $T_R(\text{max})$ and $P(\text{max})$, the required value for junction-to-ambient thermal resistance, $\theta_{(J-A)}$, can now be found:

$$\theta_{(J-A)} = T_R(\text{max})/P(\text{max}) \quad (2)$$

If the calculated value is **60° C/W or higher**, the regulator may be operated without an external heatsink. If the calculated value is **below 60° C/W**, an external heatsink is required. The required thermal resistance for this heatsink can be calculated using the formula:

$$\theta_{(H-A)} = \theta_{(J-A)} - \theta_{(J-C)} - \theta_{(C-H)}$$

where

- $\theta_{(J-C)}$ is the junction-to-case thermal resistance, which is specified as 3° C/W maximum for the LP2954
- $\theta_{(C-H)}$ is the case-to-heatsink thermal resistance, which is dependent on the interfacing material (if used). For details and typical values⁽²⁾
- $\theta_{(H-A)}$ is the heatsink-to-ambient thermal resistance. It is this specification (listed on the heatsink manufacturers data sheet) which defines the effectiveness of the heatsink. The heatsink selected must have a thermal resistance which is **equal to or lower** than the value of $\theta_{(H-A)}$ calculated from the above listed formula

PROGRAMMING THE OUTPUT VOLTAGE

The regulator may be pin-strapped for 5V operation using its internal resistive divider by tying the Output and Sense pins together and also tying the Feedback and 5V Tap pins together.

Alternatively, it may be programmed for any voltage between the 1.23V reference and the 30V maximum rating using an external pair of resistors (see Figure 24). The complete equation for the output voltage is:

$$V_{\text{OUT}} = V_{\text{REF}} \times \left(1 + \frac{R1}{R2} \right) + (I_{\text{FB}} \times R1) \quad (4)$$

- (2) The maximum allowable power dissipation is a function of the maximum junction temperature, $T_J(\text{MAX})$, the junction-to-ambient thermal resistance, θ_{J-A} , and the ambient temperature, T_A . The maximum allowable power dissipation at any ambient temperature is calculated using:

$$P(\text{MAX}) = \frac{T_J(\text{MAX}) - T_A}{\theta_{J-A}}$$

Exceeding the maximum allowable power dissipation will result in excessive die temperature, and the regulator will go into thermal shutdown. The junction-to-ambient thermal resistance of the TO-220 (without heatsink) is 60°C/W, 73°C/W for the DDPAK/TO-263, and 160°C/W for the SOIC-8. If the DDPAK/TO-263 package is used, the thermal resistance can be reduced by increasing the P.C. board copper area thermally connected to the package: Using 0.5 square inches of copper area, θ_{JA} is 50°C/W; with 1 square inch of copper area, θ_{JA} is 37°C/W; and with 1.6 or more square inches of copper area, θ_{JA} is 32°C/W. The junction-to-case thermal resistance is 3°C/W. If an external heatsink is used, the effective junction-to-ambient thermal resistance is the sum of the junction-to-case resistance (3°C/W), the specified thermal resistance of the heatsink selected, and the thermal resistance of the interface between the heatsink and the LP2954. Some typical values are listed for interface materials used with TO-220:

where V_{REF} is the 1.23V reference and I_{FB} is the Feedback pin bias current (-20 nA typical). The minimum recommended load current of 1 μ A sets an upper limit of 1.2 M Ω on the value of R2 in cases where the regulator must work with no load (see [MINIMUM LOAD](#)). I_{FB} will produce a typical 2% error in V_{OUT} which can be eliminated at room temperature by trimming R1. For better accuracy, choosing $R2 = 100$ k Ω will reduce this error to 0.17% while increasing the resistor program current to 12 μ A. Since the typical quiescent current is 120 μ A, this added current is negligible.

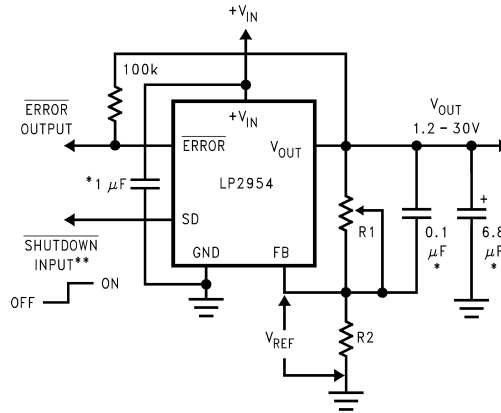

* See [Application Hints](#)

** Drive with TTL-low to shut down

Figure 24. Adjustable Regulator

DROPOUT DETECTION COMPARATOR

This comparator produces a logic “LOW” whenever the output falls out of regulation by more than about 5%. This figure results from the comparator's built-in offset of 60 mV divided by the 1.23V reference. The 5% low trip level remains constant regardless of the programmed output voltage. An out-of-regulation condition can result from low input voltage, current limiting, or thermal limiting.

[Figure 25](#) gives a timing diagram showing the relationship between the output voltage, the $\overline{\text{ERROR}}$ output, and input voltage as the input voltage is ramped up and down to a regulator programmed for 5V output. The $\overline{\text{ERROR}}$ signal becomes low at about 1.3V input. It goes high at about 5V input, where the output equals 4.75V. Since the dropout voltage is load dependent, the **input** voltage trip points will vary with load current. The **output** voltage trip point does not vary.

The comparator has an open-collector output which requires an external pull-up resistor. This resistor may be connected to the regulator output or some other supply voltage. Using the regulator output prevents an invalid “HIGH” on the comparator output which occurs if it is pulled up to an external voltage while the regulator input voltage is reduced below 1.3V. In selecting a value for the pull-up resistor, note that while the output can sink 400 μ A, this current adds to battery drain. Suggested values range from 100 k Ω to 1 M Ω . This resistor is not required if the output is unused.

When $V_{IN} \leq 1.3$ V, the error flag pin becomes a high impedance, allowing the error flag voltage to rise to its pull-up voltage. Using V_{OUT} as the pull-up voltage (rather than an external 5V source) will keep the error flag voltage below 1.2V (typical) in this condition. The user may wish to divide down the error flag voltage using equal-value resistors (10 k Ω suggested) to ensure a low-level logic signal during any fault condition, while still allowing a valid high logic level during normal operation.

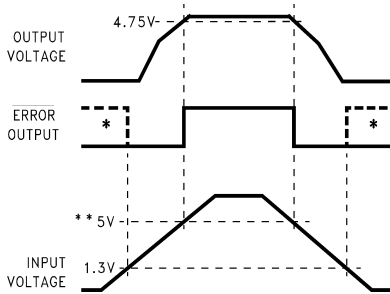

* In shutdown mode, $\overline{\text{ERROR}}$ will go high if it has been pulled up to an external supply. To avoid this invalid response, pull up to regulator output.

** Exact value depends on dropout voltage. (See [Application Hints](#))

Figure 25. $\overline{\text{ERROR}}$ Output Timing

OUTPUT ISOLATION

The regulator output can be left connected to an active voltage source (such as a battery) with the regulator input power turned off, **as long as the regulator ground pin is connected to ground**. If the ground pin is left floating, **damage to the regulator can occur** if the output is pulled up by an external voltage source.

REDUCING OUTPUT NOISE

In reference applications it may be advantageous to reduce the AC noise present on the output. One method is to reduce regulator bandwidth by increasing output capacitance. This is relatively inefficient, since large increases in capacitance are required to get significant improvement.

Noise can be reduced more effectively by a bypass capacitor placed across R1 (refer to [Figure 24](#)). The formula for selecting the capacitor to be used is:

$$C_B = \frac{1}{2\pi R1 \times 20 \text{ Hz}} \quad (5)$$

This gives a value of about 0.1 μF . When this is used, the output capacitor must be 6.8 μF (or greater) to maintain stability. The 0.1 μF capacitor reduces the high frequency gain of the circuit to unity, lowering the output noise from 260 μV to 80 μV using a 10 Hz to 100 kHz bandwidth. Also, noise is no longer proportional to the output voltage, so improvements are more pronounced at high output voltages.

SHUTDOWN INPUT

A logic-level signal will shut off the regulator output when a "LOW" (<1.2V) is applied to the $\overline{\text{Shutdown}}$ input.

To prevent possible mis-operation, the $\overline{\text{Shutdown}}$ input must be actively terminated. If the input is driven from open-collector logic, a pull-up resistor (20 k Ω to 100 k Ω recommended) should be connected from the $\overline{\text{Shutdown}}$ input to the regulator input.

If the $\overline{\text{Shutdown}}$ input is driven from a source that actively pulls high and low (like an op-amp), the pull-up resistor is not required, but may be used.

If the shutdown function is not to be used, the cost of the pull-up resistor can be saved by simply tying the $\overline{\text{Shutdown}}$ input directly to the regulator input.

IMPORTANT: Since the [Absolute Maximum Ratings](#) state that the $\overline{\text{Shutdown}}$ input can not go more than 0.3V below ground, the reverse-battery protection feature which protects the regulator input is sacrificed if the $\overline{\text{Shutdown}}$ input is tied directly to the regulator input.

If reverse-battery protection is required in an application, *the pull-up resistor between the $\overline{\text{Shutdown}}$ input and the regulator input must be used.*

Typical Applications

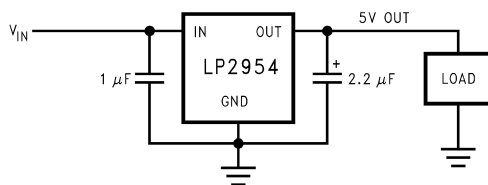

Figure 26. Typical Application Circuit

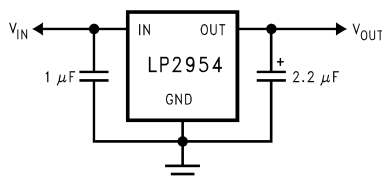
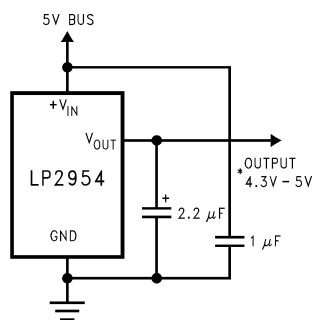

Figure 27. 5V Regulator



*Output voltage equals $+V_{IN}$ minus dropout voltage, which varies with output current. Current limits at 380 mA (typical).

Figure 28. 5V Current Limiter

Schematic Diagram

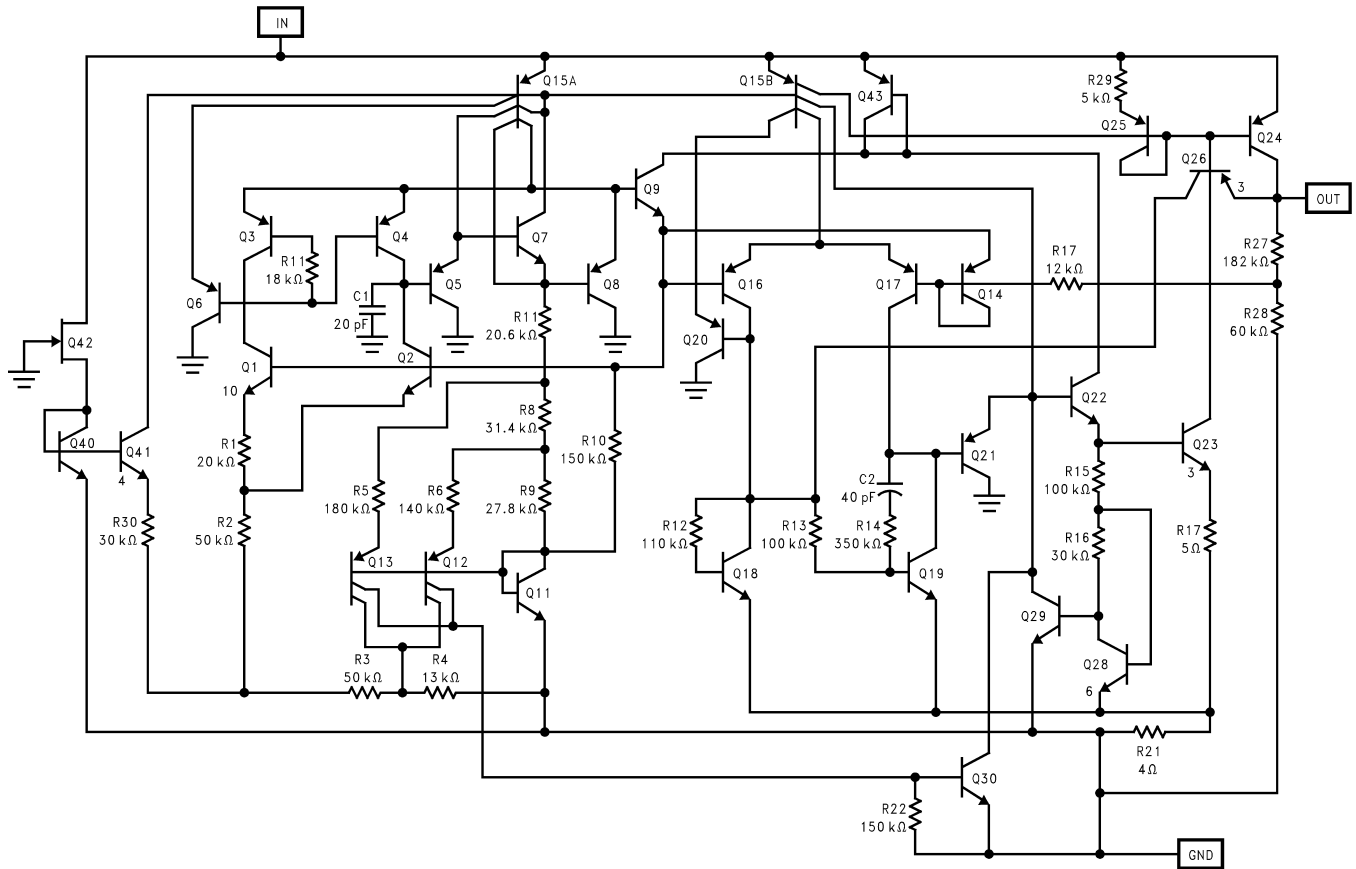

REVISION HISTORY

Changes from Revision C (March 2013) to Revision D	Page
• Changed layout of National Data Sheet to TI format	15

PACKAGING INFORMATION

Orderable Device	Status (1)	Package Type	Package Drawing	Pins	Package Qty	Eco Plan (2)	Lead/Ball Finish (6)	MSL Peak Temp (3)	Op Temp (°C)	Device Marking (4/5)	Samples
LP2954AIM	ACTIVE	SOIC	D	8	95	TBD	Call TI	Call TI	-40 to 125	LP2954AIM	Samples
LP2954AIM/NOPB	ACTIVE	SOIC	D	8	95	Green (RoHS & no Sb/Br)	SN CU SN	Level-1-260C-UNLIM	-40 to 125	LP2954AIM	Samples
LP2954AIMX/NOPB	ACTIVE	SOIC	D	8	2500	Green (RoHS & no Sb/Br)	CU SN	Level-1-260C-UNLIM	-40 to 125	LP2954AIM	Samples
LP2954AIS	ACTIVE	DDPAK/TO-263	KTT	3	45	TBD	Call TI	Call TI	-40 to 125	LP2954AIS	Samples
LP2954AIS/NOPB	ACTIVE	DDPAK/TO-263	KTT	3	45	Pb-Free (RoHS Exempt)	CU SN	Level-3-245C-168 HR	-40 to 125	LP2954AIS	Samples
LP2954AISX	ACTIVE	DDPAK/TO-263	KTT	3	500	TBD	Call TI	Call TI	-40 to 125	LP2954AIS	Samples
LP2954AISX/NOPB	ACTIVE	DDPAK/TO-263	KTT	3	500	Pb-Free (RoHS Exempt)	CU SN	Level-3-245C-168 HR	-40 to 125	LP2954AIS	Samples
LP2954AIT/NOPB	ACTIVE	TO-220	NDE	3	45	Green (RoHS & no Sb/Br)	CU SN	Level-1-NA-UNLIM	-40 to 125	LP2954AIT	Samples
LP2954IM	ACTIVE	SOIC	D	8	95	TBD	Call TI	Call TI	-40 to 125	LP2954IM	Samples
LP2954IM/NOPB	ACTIVE	SOIC	D	8	95	Green (RoHS & no Sb/Br)	CU SN	Level-1-260C-UNLIM	-40 to 125	LP2954IM	Samples
LP2954IMX/NOPB	ACTIVE	SOIC	D	8	2500	Green (RoHS & no Sb/Br)	CU SN	Level-1-260C-UNLIM	-40 to 125	LP2954IM	Samples
LP2954IS/NOPB	ACTIVE	DDPAK/TO-263	KTT	3	45	Pb-Free (RoHS Exempt)	CU SN	Level-3-245C-168 HR	-40 to 125	LP2954IS	Samples
LP2954ISX	ACTIVE	DDPAK/TO-263	KTT	3	500	TBD	Call TI	Call TI	-40 to 125	LP2954IS	Samples
LP2954ISX/NOPB	ACTIVE	DDPAK/TO-263	KTT	3	500	Pb-Free (RoHS Exempt)	CU SN	Level-3-245C-168 HR	-40 to 125	LP2954IS	Samples
LP2954IT/NOPB	ACTIVE	TO-220	NDE	3	45	Green (RoHS & no Sb/Br)	CU SN	Level-1-NA-UNLIM	-40 to 125	LP2954IT	Samples

(1) The marketing status values are defined as follows:

ACTIVE: Product device recommended for new designs.

LIFEBUY: TI has announced that the device will be discontinued, and a lifetime-buy period is in effect.

NRND: Not recommended for new designs. Device is in production to support existing customers, but TI does not recommend using this part in a new design.

PREVIEW: Device has been announced but is not in production. Samples may or may not be available.

OBSOLETE: TI has discontinued the production of the device.

⁽²⁾ Eco Plan - The planned eco-friendly classification: Pb-Free (RoHS), Pb-Free (RoHS Exempt), or Green (RoHS & no Sb/Br) - please check <http://www.ti.com/productcontent> for the latest availability information and additional product content details.

TBD: The Pb-Free/Green conversion plan has not been defined.

Pb-Free (RoHS): TI's terms "Lead-Free" or "Pb-Free" mean semiconductor products that are compatible with the current RoHS requirements for all 6 substances, including the requirement that lead not exceed 0.1% by weight in homogeneous materials. Where designed to be soldered at high temperatures, TI Pb-Free products are suitable for use in specified lead-free processes.

Pb-Free (RoHS Exempt): This component has a RoHS exemption for either 1) lead-based flip-chip solder bumps used between the die and package, or 2) lead-based die adhesive used between the die and leadframe. The component is otherwise considered Pb-Free (RoHS compatible) as defined above.

Green (RoHS & no Sb/Br): TI defines "Green" to mean Pb-Free (RoHS compatible), and free of Bromine (Br) and Antimony (Sb) based flame retardants (Br or Sb do not exceed 0.1% by weight in homogeneous material)

⁽³⁾ MSL, Peak Temp. - The Moisture Sensitivity Level rating according to the JEDEC industry standard classifications, and peak solder temperature.

⁽⁴⁾ There may be additional marking, which relates to the logo, the lot trace code information, or the environmental category on the device.

⁽⁵⁾ Multiple Device Markings will be inside parentheses. Only one Device Marking contained in parentheses and separated by a "~" will appear on a device. If a line is indented then it is a continuation of the previous line and the two combined represent the entire Device Marking for that device.

⁽⁶⁾ Lead/Ball Finish - Orderable Devices may have multiple material finish options. Finish options are separated by a vertical ruled line. Lead/Ball Finish values may wrap to two lines if the finish value exceeds the maximum column width.

Important Information and Disclaimer: The information provided on this page represents TI's knowledge and belief as of the date that it is provided. TI bases its knowledge and belief on information provided by third parties, and makes no representation or warranty as to the accuracy of such information. Efforts are underway to better integrate information from third parties. TI has taken and continues to take reasonable steps to provide representative and accurate information but may not have conducted destructive testing or chemical analysis on incoming materials and chemicals. TI and TI suppliers consider certain information to be proprietary, and thus CAS numbers and other limited information may not be available for release.

In no event shall TI's liability arising out of such information exceed the total purchase price of the TI part(s) at issue in this document sold by TI to Customer on an annual basis.

TAPE AND REEL INFORMATION



QUADRANT ASSIGNMENTS FOR PIN 1 ORIENTATION IN TAPE



*All dimensions are nominal

Device	Package Type	Package Drawing	Pins	SPQ	Reel Diameter (mm)	Reel Width W1 (mm)	A0 (mm)	B0 (mm)	K0 (mm)	P1 (mm)	W (mm)	Pin1 Quadrant
LP2954AIMX/NOPB	SOIC	D	8	2500	330.0	12.4	6.5	5.4	2.0	8.0	12.0	Q1
LP2954AISX	DDPAK/ TO-263	KTT	3	500	330.0	24.4	10.75	14.85	5.0	16.0	24.0	Q2
LP2954AISX/NOPB	DDPAK/ TO-263	KTT	3	500	330.0	24.4	10.75	14.85	5.0	16.0	24.0	Q2
LP2954IMX/NOPB	SOIC	D	8	2500	330.0	12.4	6.5	5.4	2.0	8.0	12.0	Q1
LP2954ISX	DDPAK/ TO-263	KTT	3	500	330.0	24.4	10.75	14.85	5.0	16.0	24.0	Q2
LP2954ISX/NOPB	DDPAK/ TO-263	KTT	3	500	330.0	24.4	10.75	14.85	5.0	16.0	24.0	Q2

TAPE AND REEL BOX DIMENSIONS

*All dimensions are nominal

Device	Package Type	Package Drawing	Pins	SPQ	Length (mm)	Width (mm)	Height (mm)
LP2954AIMX/NOPB	SOIC	D	8	2500	367.0	367.0	35.0
LP2954AISX	DDPAK/TO-263	KTT	3	500	367.0	367.0	45.0
LP2954AISX/NOPB	DDPAK/TO-263	KTT	3	500	367.0	367.0	45.0
LP2954IMX/NOPB	SOIC	D	8	2500	367.0	367.0	35.0
LP2954ISX	DDPAK/TO-263	KTT	3	500	367.0	367.0	45.0
LP2954ISX/NOPB	DDPAK/TO-263	KTT	3	500	367.0	367.0	45.0

NDE0003B



KTT0003B



TS3B (Rev F)

D (R-PDSO-G8)

PLASTIC SMALL OUTLINE



IMPORTANT NOTICE

Texas Instruments Incorporated and its subsidiaries (TI) reserve the right to make corrections, enhancements, improvements and other changes to its semiconductor products and services per JESD46, latest issue, and to discontinue any product or service per JESD48, latest issue. Buyers should obtain the latest relevant information before placing orders and should verify that such information is current and complete. All semiconductor products (also referred to herein as "components") are sold subject to TI's terms and conditions of sale supplied at the time of order acknowledgment.

TI warrants performance of its components to the specifications applicable at the time of sale, in accordance with the warranty in TI's terms and conditions of sale of semiconductor products. Testing and other quality control techniques are used to the extent TI deems necessary to support this warranty. Except where mandated by applicable law, testing of all parameters of each component is not necessarily performed.

TI assumes no liability for applications assistance or the design of Buyers' products. Buyers are responsible for their products and applications using TI components. To minimize the risks associated with Buyers' products and applications, Buyers should provide adequate design and operating safeguards.

TI does not warrant or represent that any license, either express or implied, is granted under any patent right, copyright, mask work right, or other intellectual property right relating to any combination, machine, or process in which TI components or services are used. Information published by TI regarding third-party products or services does not constitute a license to use such products or services or a warranty or endorsement thereof. Use of such information may require a license from a third party under the patents or other intellectual property of the third party, or a license from TI under the patents or other intellectual property of TI.

Reproduction of significant portions of TI information in TI data books or data sheets is permissible only if reproduction is without alteration and is accompanied by all associated warranties, conditions, limitations, and notices. TI is not responsible or liable for such altered documentation. Information of third parties may be subject to additional restrictions.

Resale of TI components or services with statements different from or beyond the parameters stated by TI for that component or service voids all express and any implied warranties for the associated TI component or service and is an unfair and deceptive business practice. TI is not responsible or liable for any such statements.

Buyer acknowledges and agrees that it is solely responsible for compliance with all legal, regulatory and safety-related requirements concerning its products, and any use of TI components in its applications, notwithstanding any applications-related information or support that may be provided by TI. Buyer represents and agrees that it has all the necessary expertise to create and implement safeguards which anticipate dangerous consequences of failures, monitor failures and their consequences, lessen the likelihood of failures that might cause harm and take appropriate remedial actions. Buyer will fully indemnify TI and its representatives against any damages arising out of the use of any TI components in safety-critical applications.

In some cases, TI components may be promoted specifically to facilitate safety-related applications. With such components, TI's goal is to help enable customers to design and create their own end-product solutions that meet applicable functional safety standards and requirements. Nonetheless, such components are subject to these terms.

No TI components are authorized for use in FDA Class III (or similar life-critical medical equipment) unless authorized officers of the parties have executed a special agreement specifically governing such use.

Only those TI components which TI has specifically designated as military grade or "enhanced plastic" are designed and intended for use in military/aerospace applications or environments. Buyer acknowledges and agrees that any military or aerospace use of TI components which have **not** been so designated is solely at the Buyer's risk, and that Buyer is solely responsible for compliance with all legal and regulatory requirements in connection with such use.

TI has specifically designated certain components as meeting ISO/TS16949 requirements, mainly for automotive use. In any case of use of non-designated products, TI will not be responsible for any failure to meet ISO/TS16949.

Products

Audio	www.ti.com/audio
Amplifiers	amplifier.ti.com
Data Converters	dataconverter.ti.com
DLP® Products	www.dlp.com
DSP	dsp.ti.com
Clocks and Timers	www.ti.com/clocks
Interface	interface.ti.com
Logic	logic.ti.com
Power Mgmt	power.ti.com
Microcontrollers	microcontroller.ti.com
RFID	www.ti-rfid.com
OMAP Applications Processors	www.ti.com/omap
Wireless Connectivity	www.ti.com/wirelessconnectivity

Applications

Automotive and Transportation	www.ti.com/automotive
Communications and Telecom	www.ti.com/communications
Computers and Peripherals	www.ti.com/computers
Consumer Electronics	www.ti.com/consumer-apps
Energy and Lighting	www.ti.com/energy
Industrial	www.ti.com/industrial
Medical	www.ti.com/medical
Security	www.ti.com/security
Space, Avionics and Defense	www.ti.com/space-avionics-defense
Video and Imaging	www.ti.com/video

TI E2E Community

e2e.ti.com