

Dimensions for 4pins & 2pins connector

TECHNICAL CHARACTERISTICS

MATERIAL
 INSULATOR: NYLON 66
 FLAMABILITY RATING: UL94-V0
 COLOR: WHITE
 PITCH: 4.20MM

ENVIRONMENTAL
 OPERATING TEMPERATURE: -40 UP TO 105°C
 COMPLIANCE: LEAD FREE AND ROHS

ELECTRICAL
 CURRENT RATING: 6 TO 9A

NB CIRCUITS □	2-3 □	4-6 □	7-10 □	12-24
AMPERES □	9 □	8 □	7 □	6

WORKING VOLTAGE: 600V AC
 INSULATOR RESISTANCE: >1000 MOHM
 DIELECTRIC WITHSTANDING VOLTAGE: 1500V AC/MN

STANDARD
 CERTIFIED: E323964 / MODEL NUMBER 649-1133

PACKAGING
 BAG

DIMENSION
 A = 4.20 x (NB. PIN / 2 - 1)
 B = 4.20 x (NB. PIN / 2) + 1.20

RoHS Compliant	
G	01-OCT-10
F	18-NOV-09
E	24-JUN-09
D	23-AVR-09
C	12-NOV-08
B □	20-MAR-07 □
A □	□ □
REV	DATE

DRAWING	JC
STANDARD	JP
BAG PACKAGING	JP
PACKAGING	JC
UL 94-V0 & PINING	JP
DRAW □ □	EC
LEAD FREE □	JP
FILE	BY

PROJECTION:	
APPROVAL: RJ	

GENERAL TOLERANCE
.X = +/- 0.2
.XX = +/- 0.15
UNIT: MM
SCALE:
SHEET: 1/2
DRAW: PEARL

DESCRIPTION: 4.20MM FEMALE DUAL ROW RECEPTACLE	
WERI PART NO: 649 0xx 113 322	

SIZE
A4

A
B
C
D

1

2

3

4

5

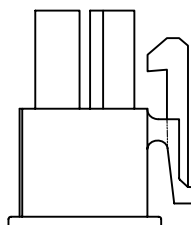
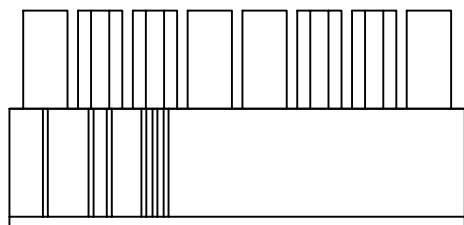
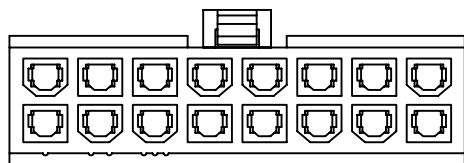

Note:

1.Dimension:

Carton Size:40*28*28(cm)

2.Quantity:

Pin.	Pcs/Bag	Pcs/Carton	Pin.	Pcs/Bag	Pcs/Carton
2	1000	16000	14	500	6000
4	1000	16000	16	500	5000
6	1000	12000	18	500	5000
8	1000	10000	20	300	3000
10	500	8000	22	300	2400
12	500	8000	24	300	2400

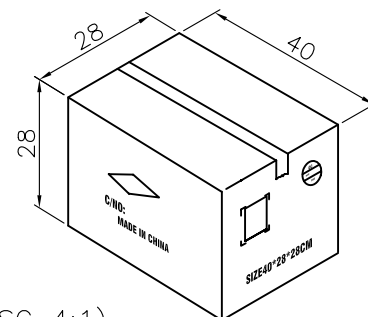
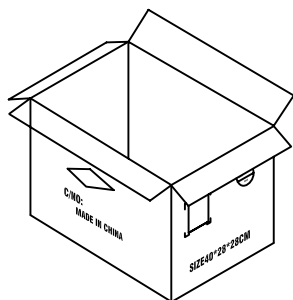
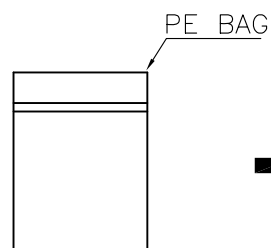

Carton (SC 4:1)

RoHS Compliant

G			
F			
E			
D			
C			
B			
A			
REV	DATE	FILE	BY

PROJECTION:

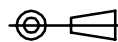

APPROVAL: RJ

GENERAL TOLERANCE

.X = +/- 0.2

.XX = +/- 0.15

UNIT: MM

SCALE:

SHEET: 2/2

DRAW: PEARL



DESCRIPTION: 4.20MM FEMALE DUAL ROW RECEPTACLE

WERI PART NO: 6490 xx 113322_TPK

SIZE

A4