

FFP15S60S

15 A, 600 V, STEALTH™ II Diode

Features

- Stealth Recovery $T_{rr} = 35 \text{ ns}$ (@ $I_F = 15 \text{ A}$)
- Max Forward Voltage, $V_F = 2.6 \text{ V}$ (@ $T_C = 25^\circ\text{C}$)
- 600V Reverse Voltage and High Reliability
- Improved dv/dt Capability
- RoHS Compliant

Applications

- General Purpose
- SMPS
- Boost Diode in Continuous Mode Power Factor Corrections
- Power Switching Circuits

Description

The FFP15S60S is a STEALTH™ II diode with soft recovery characteristics. It is silicon nitride passivated ion-implanted epitaxial planar construction. This device is intended for use as freewheeling of boost diode in switching power supplies and other power switching applications. Their low stored charge and hyperfast soft recovery minimize ringing and electrical noise in many power switching circuits reducing power loss in the switching transistors.



TO-220-2L
1. Cathode 2. Anode

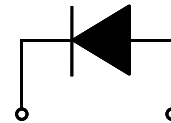

1. Cathode 2. Anode

Absolute Maximum Ratings $T_C = 25^\circ\text{C}$ unless otherwise noted

Symbol	Parameter	Rating	Unit
V_{RRM}	Peak Repetitive Reverse Voltage	600	V
V_{RWM}	Working Peak Reverse Voltage	600	V
V_R	DC Blocking Voltage	600	V
$I_{F(AV)}$	Average Rectified Forward Current @ $T_C = 123^\circ\text{C}$	15	A
I_{FSM}	Non-repetitive Peak Surge Current 60Hz Single Half-Sine Wave	150	A
T_J, T_{STG}	Operating and Storage Temperature Range	-65 to +150	$^\circ\text{C}$

Thermal Characteristics

Symbol	Parameter	Max.	Unit
$R_{\theta JC}$	Maximum Thermal Resistance, Junction to Case	1.3	$^\circ\text{C/W}$

Package Marking and Ordering Information

Part Number	Top Mark	Package	Packing Method	Reel Size	Tape Width	Quantity
FFP15S60STU	FFP15S60S	TO-220-2L	Tube	N/A	N/A	50

Electrical Characteristics $T_C = 25^\circ\text{C}$ unless otherwise noted

Symbol	Parameter	Min.	Typ.	Max.	Unit
V_{F1}	$I_F = 15\text{ A}$ $I_F = 15\text{ A}$	-	2.1	2.6	V
I_{R1}	$V_R = 600\text{ V}$ $V_R = 600\text{ V}$	-	-	100 500	μA
t_{rr}	$I_F = 1\text{ A}$, $di_F/dt = 100\text{ A}/\mu\text{s}$, $V_R = 30\text{ V}$	-	21	30	ns
t_{rr} I_{rr} S factor Q_{rr}	$I_F = 15\text{ A}$, $di_F/dt = 200\text{ A}/\mu\text{s}$, $V_R = 390\text{ V}$	- - - -	23 2.5 0.7 29	35 - - -	ns A - nC
t_{rr} I_{rr} S factor Q_{rr}	$I_F = 15\text{ A}$, $di_F/dt = 200\text{ A}/\mu\text{s}$, $V_R = 390\text{ V}$	- - - -	55 4.3 1.1 118	- - - -	ns A - nC
W_{AVL}	Avalanche Energy ($L = 40\text{ mH}$)	20	-	-	mJ

Notes:

1: Pulse: Test Pulse width = 300 μs , Duty Cycle = 2%

Test Circuit and Waveforms

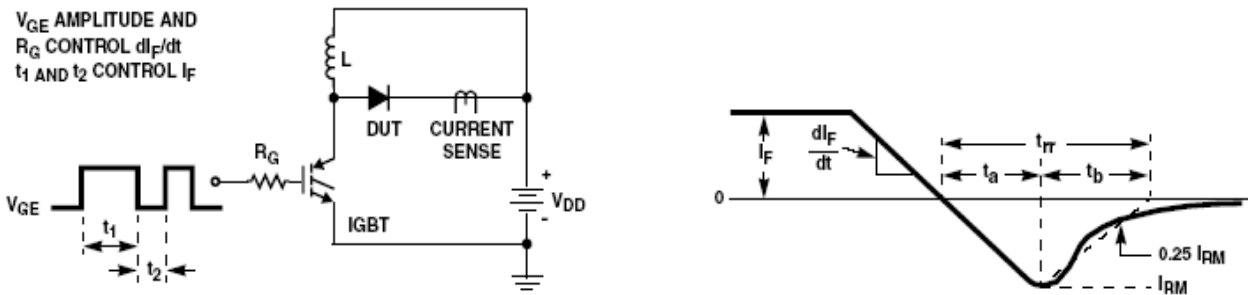

Figure 1. Diode Reverse Recovery Test Circuit & Waveform

$L = 40\text{ mH}$
 $R < 0.1\Omega$
 $V_{DD} = 50\text{ V}$

$E_{AVL} = 1/2LI^2 [V_{R(AVL)}/(V_{R(AVL)} - V_{DD})]$
 $Q1 = \text{IGBT (}BV_{CES} > \text{DUT } V_{R(AVL)}\text{)}$

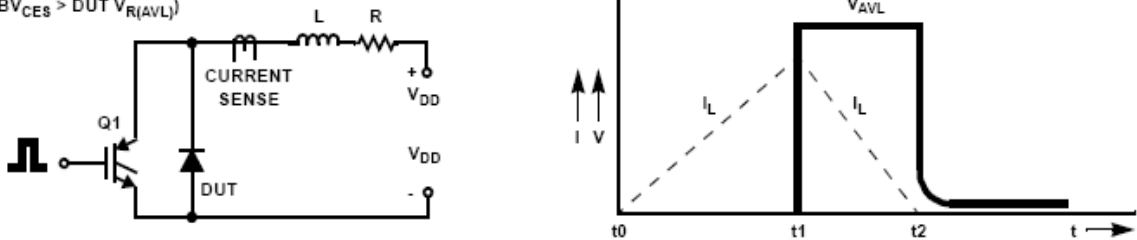

Figure 2. Unclamped Inductive Switching Test Circuit & Waveform

Typical Performance Characteristics

Figure 3. Typical Forward Voltage Drop vs. Forward Current

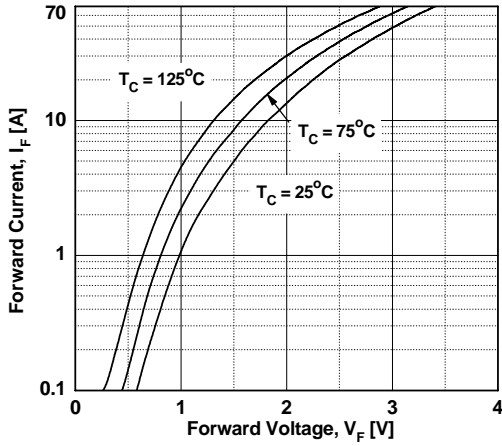

Figure 4. Typical Reverse Current vs. Reverse Voltage

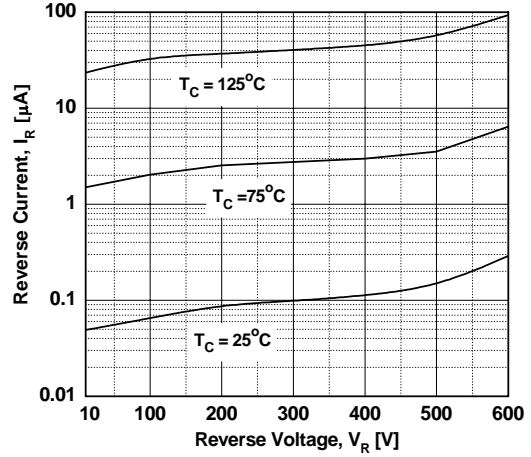

Figure 5. Typical Junction Capacitance

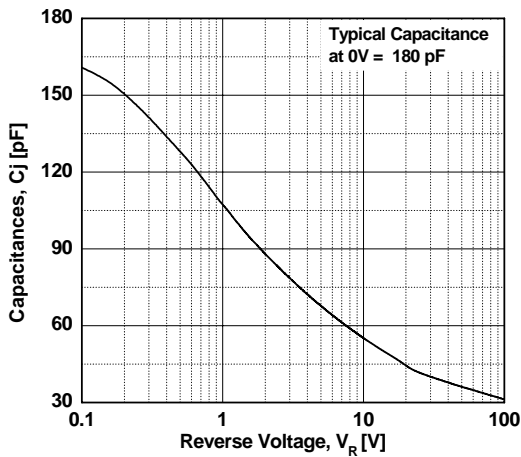

Figure 6. Typical Reverse Recovery Time vs. di_F/dt

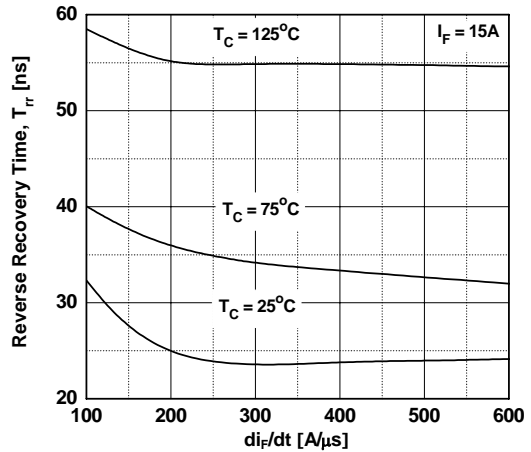

Figure 7. Typical Reverse Recovery Current vs. di_F/dt

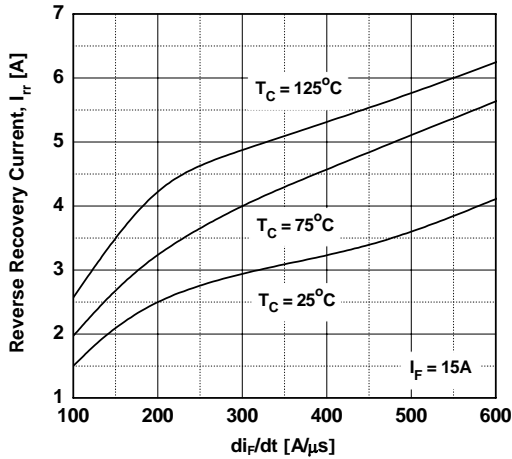
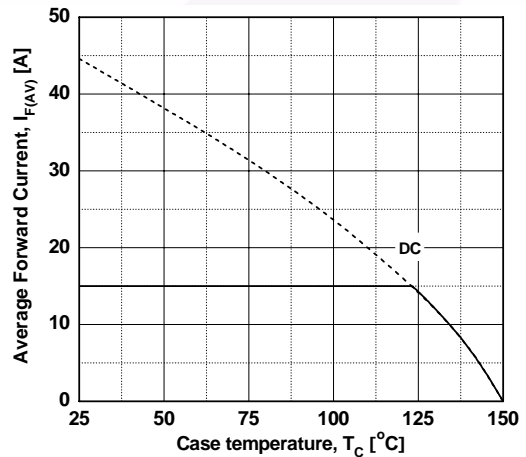

Figure 8. Forward Current Derating Curve



Mechanical Dimensions

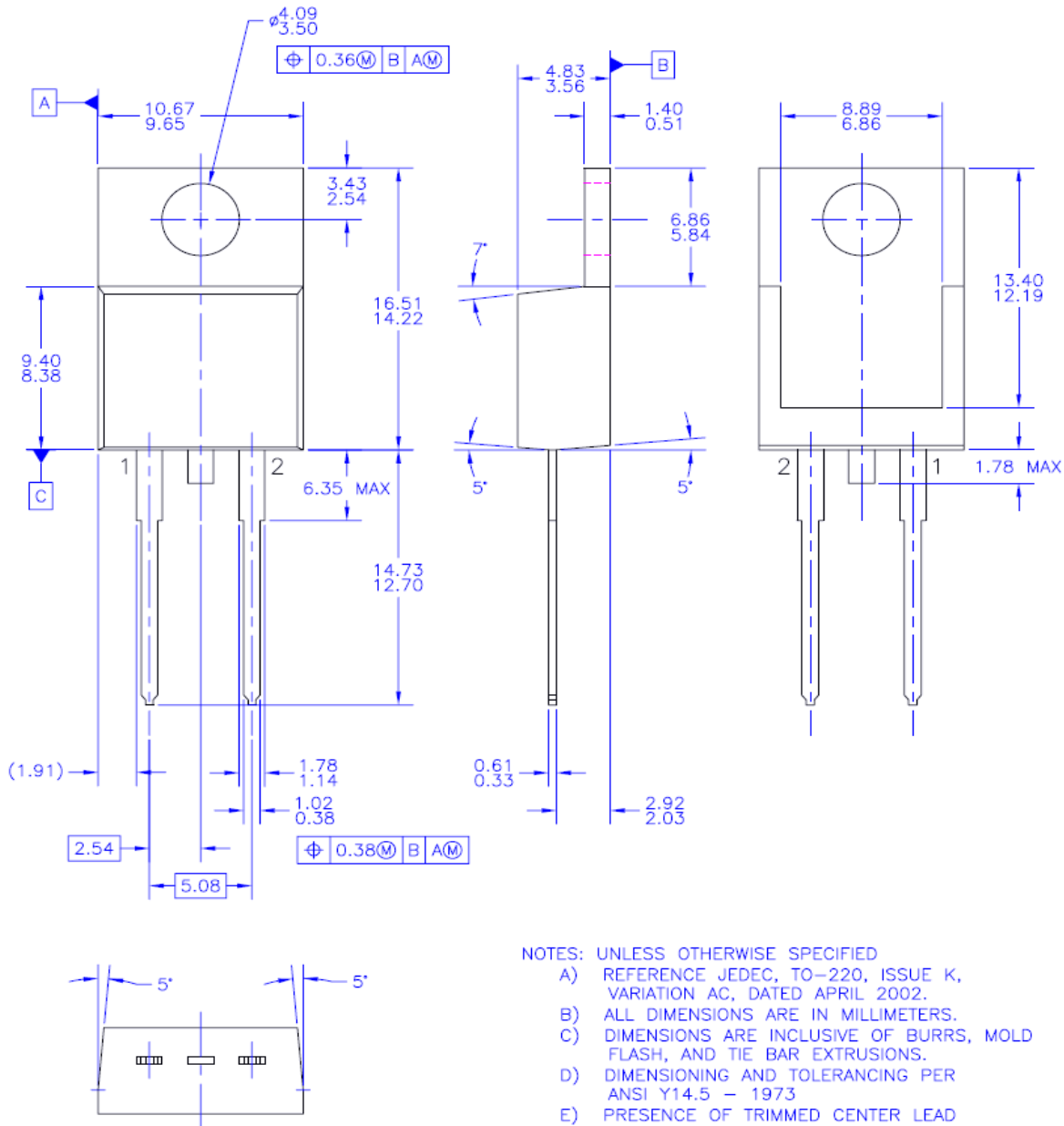

Figure 9. TO-220 2L - 2LD, TO220, JEDEC TO-220 VARIATION AC

Package drawings are provided as a service to customers considering Fairchild components. Drawings may change in any manner without notice. Please note the revision and/or date on the drawing and contact a Fairchild Semiconductor representative to verify or obtain the most recent revision. Package specifications do not expand the terms of Fairchild's worldwide terms and conditions, specifically the warranty therein, which covers Fairchild products.

Always visit Fairchild Semiconductor's online packaging area for the most recent package drawings:

http://www.fairchildsemi.com/package/packageDetails.html?id=PN_TT220-0B2



TRADEMARKS

The following includes registered and unregistered trademarks and service marks, owned by Fairchild Semiconductor and/or its global subsidiaries, and is not intended to be an exhaustive list of all such trademarks.

- | | | | |
|--------------------------|---|---------------------------------------|---------------------------|
| AccuPower™ | F-PFST™ | PowerTrench® | Sync-Lock™ |
| AX-CAP®* | FRFET® | PowerXST™ | SYSTEM ®* |
| BitSiC™ | Global Power ResourceSM | Programmable Active Droop™ | TinyBoost® |
| Build it Now™ | GreenBridge™ | QFET® | TinyBuck® |
| CorePLUS™ | Green FPS™ | QS™ | TinyCalc™ |
| CorePOWER™ | Green FPS™ e-Series™ | Quiet Series™ | TinyLogic® |
| CROSSVOL7™ | Gmax™ | RapidConfigure™ | TINYOPTO™ |
| CTL™ | GTO™ | SM | TinyPower™ |
| Current Transfer Logic™ | IntelliMAX™ | Saving our world, 1mW/W/kW at a time™ | TinyPWM™ |
| DEUXPEED® | ISOPLANAR™ | SignalWise™ | TinyWire™ |
| Dual Cool™ | Marking Small Speakers Sound Louder and Better™ | SmartMax™ | TranSiC™ TriFault Detect™ |
| EcoSPARK® | MegaBuck™ | SMART START™ | TRUECURRENT®* |
| EfficientMax™ | MICROCOUPLER™ | Solutions for Your Success™ | μSerDes™ |
| ESBC™ | MicroFET™ | SPM® | SerDes ™ |
| F ® | MicroPak™ | STEALTH™ | UHC® |
| Fairchild® | MicroPak2™ | SuperFET® | Ultra FRFET™ |
| Fairchild Semiconductor® | MillerDrive™ | SuperSOT™-3 | UniFET™ |
| FACT Quiet Series™ | MotionMax™ | SuperSOT™-6 | VCX™ |
| FACT® | mWSaver® | SuperSOT™-8 | VisualMax™ |
| FAST® | OptoHIT™ | SupreMOS® | VoltagePlus™ |
| FastvCore™ | OPTOLOGIC® | SyncFET™ | XS™ |
| FETBench™ | OPTOPLANAR® | | |
| FPS™ | | | |

*Trademarks of System General Corporation, used under license by Fairchild Semiconductor.

DISCLAIMER

FAIRCHILD SEMICONDUCTOR RESERVES THE RIGHT TO MAKE CHANGES WITHOUT FURTHER NOTICE TO ANY PRODUCTS HEREIN TO IMPROVE RELIABILITY, FUNCTION, OR DESIGN. FAIRCHILD DOES NOT ASSUME ANY LIABILITY ARISING OUT OF THE APPLICATION OR USE OF ANY PRODUCT OR CIRCUIT DESCRIBED HEREIN; NEITHER DOES IT CONVEY ANY LICENSE UNDER ITS PATENT RIGHTS, NOR THE RIGHTS OF OTHERS. THESE SPECIFICATIONS DO NOT EXPAND THE TERMS OF FAIRCHILD'S WORLDWIDE TERMS AND CONDITIONS, SPECIFICALLY THE WARRANTY THEREIN, WHICH COVERS THESE PRODUCTS.

LIFE SUPPORT POLICY

FAIRCHILD'S PRODUCTS ARE NOT AUTHORIZED FOR USE AS CRITICAL COMPONENTS IN LIFE SUPPORT DEVICES OR SYSTEMS WITHOUT THE EXPRESS WRITTEN APPROVAL OF FAIRCHILD SEMICONDUCTOR CORPORATION.

As used here in:

1. Life support devices or systems are devices or systems which, (a) are intended for surgical implant into the body or (b) support or sustain life, and (c) whose failure to perform when properly used in accordance with instructions for use provided in the labeling, can be reasonably expected to result in a significant injury of the user.
2. A critical component in any component of a life support, device, or system whose failure to perform can be reasonably expected to cause the failure of the life support device or system, or to affect its safety or effectiveness.

ANTI-COUNTERFEITING POLICY

Fairchild Semiconductor Corporation's Anti-Counterfeiting Policy. Fairchild's Anti-Counterfeiting Policy is also stated on our external website, www.Fairchildsemi.com, under Sales Support.

Counterfeiting of semiconductor parts is a growing problem in the industry. All manufactures of semiconductor products are experiencing counterfeiting of their parts. Customers who inadvertently purchase counterfeit parts experience many problems such as loss of brand reputation, substandard performance, failed application, and increased cost of production and manufacturing delays. Fairchild is taking strong measures to protect ourselves and our customers from the proliferation of counterfeit parts. Fairchild strongly encourages customers to purchase Fairchild parts either directly from Fairchild or from Authorized Fairchild Distributors who are listed by country on our web page cited above. Products customers buy either from Fairchild directly or from Authorized Fairchild Distributors are genuine parts, have full traceability, meet Fairchild's quality standards for handling and storage and provide access to Fairchild's full range of up-to-date technical and product information. Fairchild and our Authorized Distributors will stand behind all warranties and will appropriately address and warranty issues that may arise. Fairchild will not provide any warranty coverage or other assistance for parts bought from Unauthorized Sources. Fairchild is committed to combat this global problem and encourage our customers to do their part in stopping this practice by buying direct or from authorized distributors.

PRODUCT STATUS DEFINITIONS

Definition of Terms

Datasheet Identification	Product Status	Definition
Advance Information	Formative / In Design	Datasheet contains the design specifications for product development. Specifications may change in any manner without notice.
Preliminary	First Production	Datasheet contains preliminary data; supplementary data will be published at a later date. Fairchild Semiconductor reserves the right to make changes at any time without notice to improve design.
No Identification Needed	Full Production	Datasheet contains final specifications. Fairchild Semiconductor reserves the right to make changes at any time without notice to improve the design.
Obsolete	Not In Production	Datasheet contains specifications on a product that is discontinued by Fairchild Semiconductor. The datasheet is for reference information only.

Rev. I66