

Honeywell Zephyr™ Digital Airflow Sensors: HAF Series—High Accuracy 20 SLPM or 200 SLPM



DESCRIPTION

Honeywell Zephyr™ HAF Series sensors provide a digital interface for reading airflow over specified full-scale flow and compensated temperature ranges. The thermally isolated heater and temperature sensing elements help these sensors provide a fast response to air or gas flow.

Zephyr sensors are designed to measure mass flow of air and other non-corrosive gases. Standard flow ranges are 20 SLPM or 200 SLPM, with custom flow ranges available. The sensors are fully calibrated and temperature compensated with an onboard Application Specific Integrated Circuit (ASIC).

The HAF Series >20 SLPM is compensated over the calibrated temperature range of 0 °C to 50 °C [32 °F to 122 °F]. The state-of-the-art ASIC-based compensation provides digital (I²C) outputs with a response time of 1 ms.

FEATURES AND BENEFITS (★=competitive differentiator)

- ★ Total Error Band (TEB) is $\pm 0.5\%$ FS or $\pm 4\%$ reading, whichever is greater, allowing for precise airflow measurement often ideal for demanding applications with high accuracy requirements for precise airflow measurement
- ★ High accuracy ($\pm 3.5\%$ reading) often ideal for demanding applications with high accuracy requirements
- ★ Fast response time allows a customer's application to respond quickly to airflow change, important in critical medical (e.g., anesthesia) and industrial (e.g., fume hood) applications
- ★ Wide range of airflows: Zephyr measures mass flow with standard flow ranges of 20 SLPM and 200 SLPM, or custom flow ranges, increasing the options for integrating the sensor into the application
- Full calibration and temperature compensation typically allow customer to remove additional components associated with signal conditioning from the PCB, reducing PCB size as well as costs often associated with those components (e.g., acquisition, inventory, assembly)
- High sensitivity at very low flows provides for faster response time at the onset or cessation of flow
- ★ Linear output provides more intuitive sensor signal than the raw output of basic airflow sensors, which can help reduce production costs, design, and implementation time
- ★ Customizable flow ranges and configurable package styles to meet specific end-user needs
- ★ High stability reduces errors due to thermal effects and null shift to provide accurate readings over time, often eliminating need for system calibration after PCB mount and periodically over time
- ★ Low pressure drop typically improves patient comfort in medical applications, and reduces noise and system wear on other components such as motors and pumps
- High 12-bit resolution increases ability to sense small airflow changes, allowing customers to more precisely control their application
- Flexible regulated powers from 3 Vdc to 10 Vdc give the designer the flexibility to choose what supply voltage works best in the system
- ASIC-based I²C digital output compatibility eases integration to microprocessors or microcontrollers, reducing PCB complexity and component count
- RoHS-compliant materials meet Directive 2002/95/EC
- Choice of port styles (manifold mount, 22 mm OD tapered male fitting, and G 3/8 female threaded fitting) provide flexibility to choose the pneumatic connection that is best for the customer's application
- Optimized calibration for many gases, including dry air, helium (He), argon (Ar), nitrogen (N₂), nitrous oxide (N₂O), and carbon dioxide (CO₂) eliminates the need to implement gas correction factors

These sensors operate on the heat transfer principle to measure mass airflow. They consist of a microbridge Microelectronic and Microelectromechanical System (MEMS) with temperature-sensitive resistors deposited with thin films of platinum and silicon nitride. The MEMS sensing die is located in a precise and carefully designed airflow channel to provide repeatable response to flow.

Zephyr sensors provide the customer with enhanced reliability, high accuracy, repeatable measurements and the ability to customize sensor options to meet many specific application needs. The combination of rugged housings with a stable substrate makes these products extremely robust. They are designed and manufactured according to ISO 9001 standards.

Honeywell Zephyr™ Digital Airflow Sensors

HAF Series—High Accuracy

POTENTIAL APPLICATIONS

Medical

- Anesthesia delivery machines
- Ventilators
- Ventricular assist devices (heart pumps)
- Patient monitoring systems (respiratory monitoring)
- Spirometers
- Laparoscopy

Industrial

- Analytic instrumentation (spectrometry, chromatography)
- Air-to-fuel ratio
- Fuel cells
- Fume hoods
- Gas leak detection
- Gas meters

Table 1: Absolute Maximum Ratings¹

Characteristic	Parameter
Supply voltage	-0.3 Vdc to 11.0 Vdc
Voltage on digital I/O output pins	-0.3 Vdc to 3.0 Vdc ²
Storage temperature range	-40 °C to 100 °C [-40 °F to 212 °F]
Maximum flow change	10,000 SLPM/s
Maximum common mode pressure	60 psi at 25 °C [77 °F]
Maximum flow	350 SLPM

CAUTION

IMPROPER USE

Do not use these products to sense liquid flow.

Failure to comply with these instructions may result in product damage.

CAUTION

PRODUCT DAMAGE

Do not disassemble these products.

Failure to comply with these instructions may result in product damage.

1. Absolute maximum ratings are the extreme limits that the device will withstand without damage to the device. However, the electrical and mechanical characteristics are not guaranteed as the maximum limits (above recommended operating conditions) are approached, nor will the device necessarily operate at absolute maximum ratings.
2. Digital I/O pins are diode protected at this voltage up to 2 mA. Digital bus voltage may exceed this value if the maximum digital bus current is limited to 2 mA or less. The maximum bus current is generally determined by the bus pull-up resistors.

Table 2: Operating Characteristics

Characteristic	Parameter	Note
Supply voltage	3 Vdc to 10 Vdc	–
Supply current	20 mA max.	–
Power	3 Vdc: 60 mW max., 10 Vdc: 200 mW max.	–
Calibrated temperature range	0 °C to 50 °C [32 °F to 122 °F]	3
Operating temperature range	-20 °C to 70 °C [-4 °F to 158 °F]	–
Full scale (FS) flow	20 SLPM or 200 SLPM	4
Calibrated flow range	0 to 20 SLPM or 0 to 200 SLPM	–
Calibration gas	clean, dry air	5
Accuracy	absolute greater of $\pm 3.5\%$ of reading or $\pm 0.5\%$ FS (See Figure 4.)	6
Total error band (TEB)	absolute greater of $\pm 4.0\%$ of reading or $\pm 0.5\%$ FS (See Figure 4.)	7
Null accuracy	$\pm 0.5\%$ FS	8
Flow response time	1 ms	9
Warm up time	35 ms	10
Resolution:		–
20 SLPM	0.003 SLPM (min.)	
200 SLPM	0.02 SLPM (min.)	
Bus standards	I ² C fast mode (up to 400 kHz)	11
Proof pressure	150 psig	–
Burst pressure	200 psig	–
Reverse polarity protection	no	–

Notes:

3. Custom and extended temperature compensated ranges are possible. Contact Honeywell for details.
4. Honeywell standard for mass flow rate units is SLPM, which has reference conditions of 0 °C and 1 atm. Custom units are given as LPM with listed reference conditions at the first mention.
5. Contact Honeywell for requirements with other custom gases for calibration. See the Technical Note "[Gas Media Compatibility and Correction Factors](#)".
6. Accuracy is the maximum deviation in output from nominal over the entire calibrated flow range at 25 °C. Errors include Offset, Full Scale Span, Linearity, Flow Hysteresis, and Repeatability (see Figures 3 and 4).
7. Total Error Band (TEB) is the maximum deviation in output from nominal over the entire calibrated flow range and temperature range. Total Error Band includes all Accuracy errors, as well as all temperature effects over the compensated temperature range, including Temperature Offset, Temperature Span and Thermal Hysteresis.
8. Null Accuracy is the maximum deviation in output from nominal at null flow over the entire calibrated temperature range.
9. Response time: time to electrically respond to any mass flow change at the microbridge airflow transducer (response time of the transducer may be affected by the pneumatic interface).
10. Warm-up time: time to the first valid flow measurement after power is applied.
11. Refer to the Technical Note "[I²C Communications with Honeywell Digital Airflow Sensors](#)" for I²C protocol information.

20 SLPM or 200 SLPM

Table 3. Compatible Gases

Gas	Calibration Type
Dry air	standard calibration
Helium (He)	optimized calibration available
Argon (Ar)	
Nitrogen (N ₂)	
Nitrous oxide (N ₂ O)	
Carbon dioxide (CO ₂)	
Oxygen (O ₂)	See the Technical Note " Gas Media Compatibility and Correction Factors ".
80/20 He/O ₂ mix	
Methane (CH ₄)	
Xenon (Xe)	

Table 4. Environmental Characteristics

Characteristic	Parameter
Humidity	0% to 95% RH, non-condensing
Shock	30 g, 6 ms
Vibration	1.33 g at 10 Hz to 500 Hz
ESD	IEC6100-4-2 air discharge up to 8 kV, or direct contact discharge up to 4 kV
Radiated immunity	Level 3 from (80 MHz to 1000 MHz) per spec IEC61000-4-3

Table 5. Materials

Characteristic	Parameter
Wetted materials	glass reinforced (GR) thermoplastic polymer, gold, silicon, silicon dioxide, silicon nitride, epoxy, PCB epoxy composite
Housing	GR thermoplastic polymer
Substrate	PCB
Adhesives	epoxy
Electronic components	silicon, gold
Compliance	RoHS, WEEE

Table 6. Recommended Mounting and Implementation

Characteristic	Parameter
Mounting screw size	10-32
Mounting screw torque	1,13 N m [20 ±10 in-lb]
Electrical connection	6 pin SIP connector
Pneumatic connection	manifold mount, 22 mm OD tapered male fitting, G 3/8 female threaded fitting
Filter recommendation	5-micron filter upstream of the sensor

CAUTION

LARGE PARTICULATE DAMAGE

Use a 5-micron filter upstream of the sensor to keep media flow through the sensor free of condensing moisture and particulates. Large, high-velocity particles or conductive particles may damage the sensing element.

Failure to comply with these instructions may result in product damage.

Figure 1. Nomenclature and Order Guide

For example, a **HAFUHM0020L4AXT** part number defines a Honeywell Zephyr™ Airflow Sensor, unidirectional flow, long port, manifold mount, 20 SLPM, 1°C output with custom 0x49 address, 10% to 90% transfer function, 3 V to 10 V supply voltage.

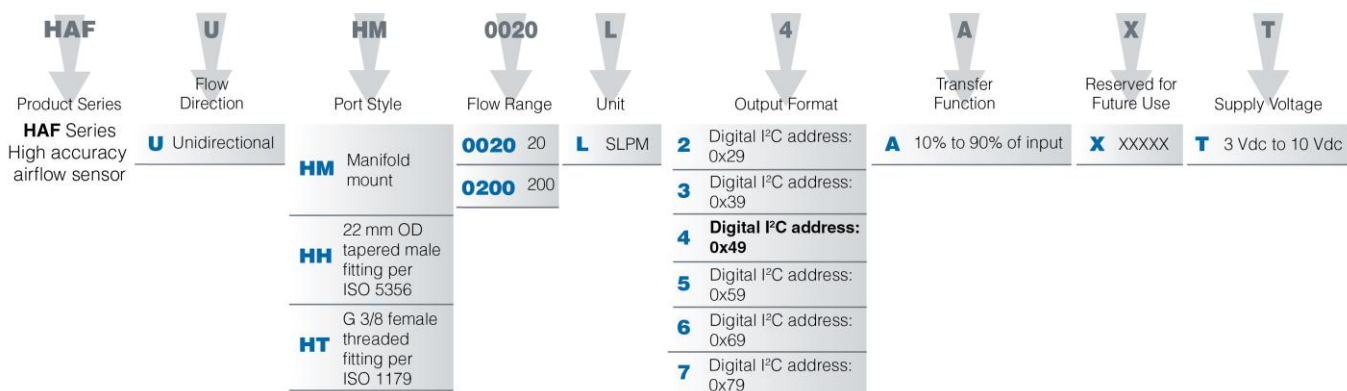

Note: Apart from the general configuration required, other customer-specific requirements are also possible. Please contact Honeywell.

Honeywell Zephyr™ Digital Airflow Sensors

HAF Series—High Accuracy

Figure 2. Nominal Digital Output

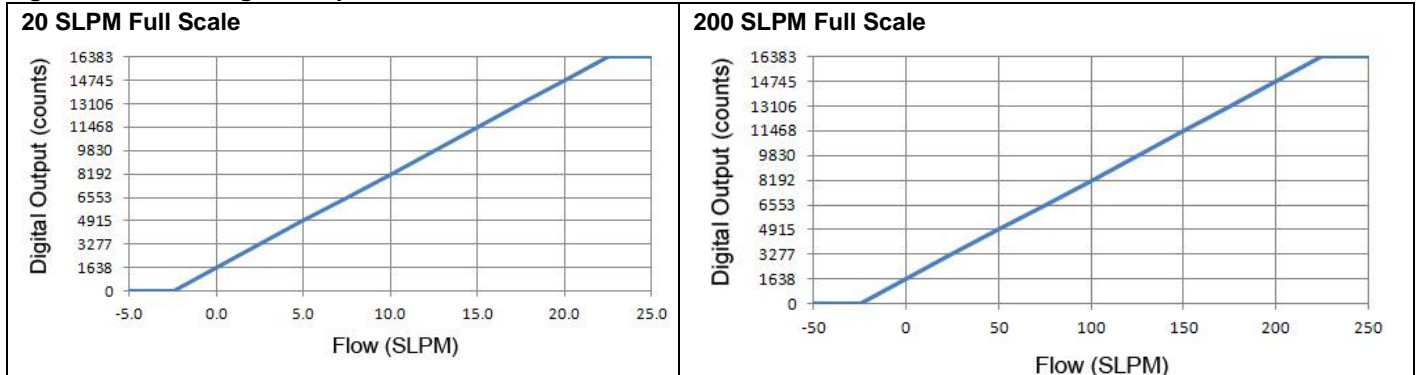

Figure 3. Total Error Band Explanation, 20 SLPM and 200 SLPM

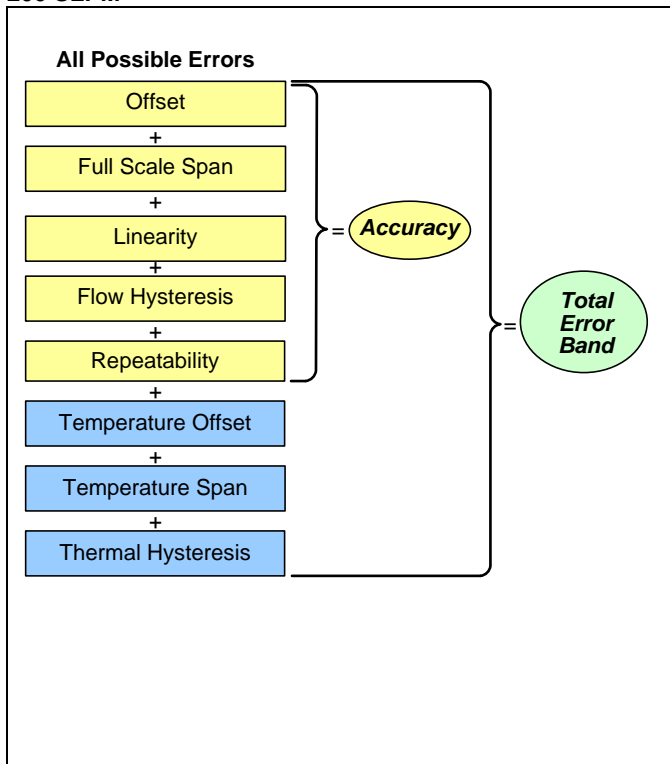

Figure 4. Accuracy and Total Error Band, 20 SLPM and 200 SLPM

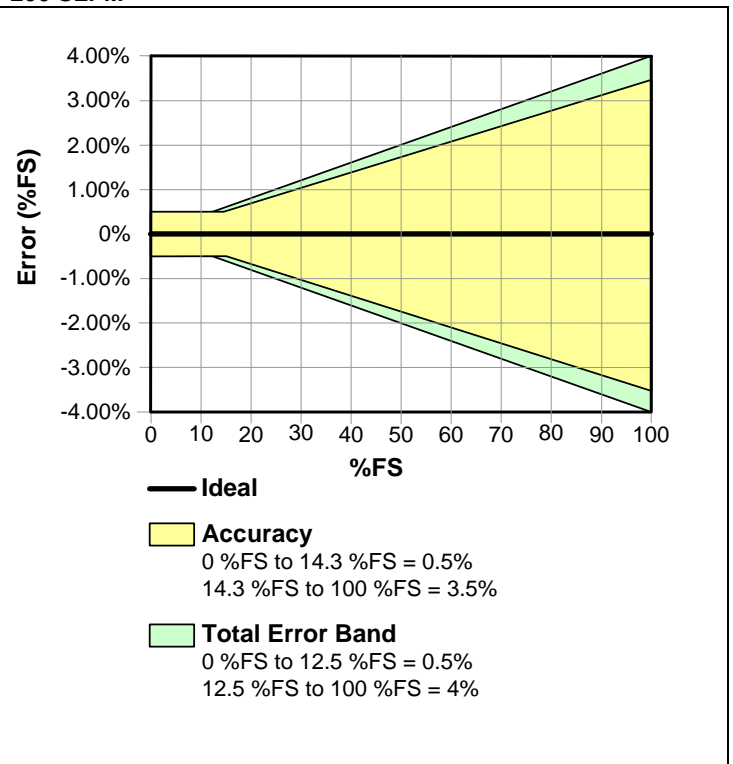

Table 7. Ideal Transfer Function

$$\text{Digital Output Code} = 16384 * [0.1 + 0.8 * (\text{Flow Applied}/\text{Full Scale Flow})]$$

$$\text{Flow Applied} = \text{Full Scale Flow} * [(\text{Digital Output Code}/16384) - 0.1]/0.8$$

20 SLPM or 200 SLPM

Figure 5. Flow vs Pressure Drop: 20 SLPM

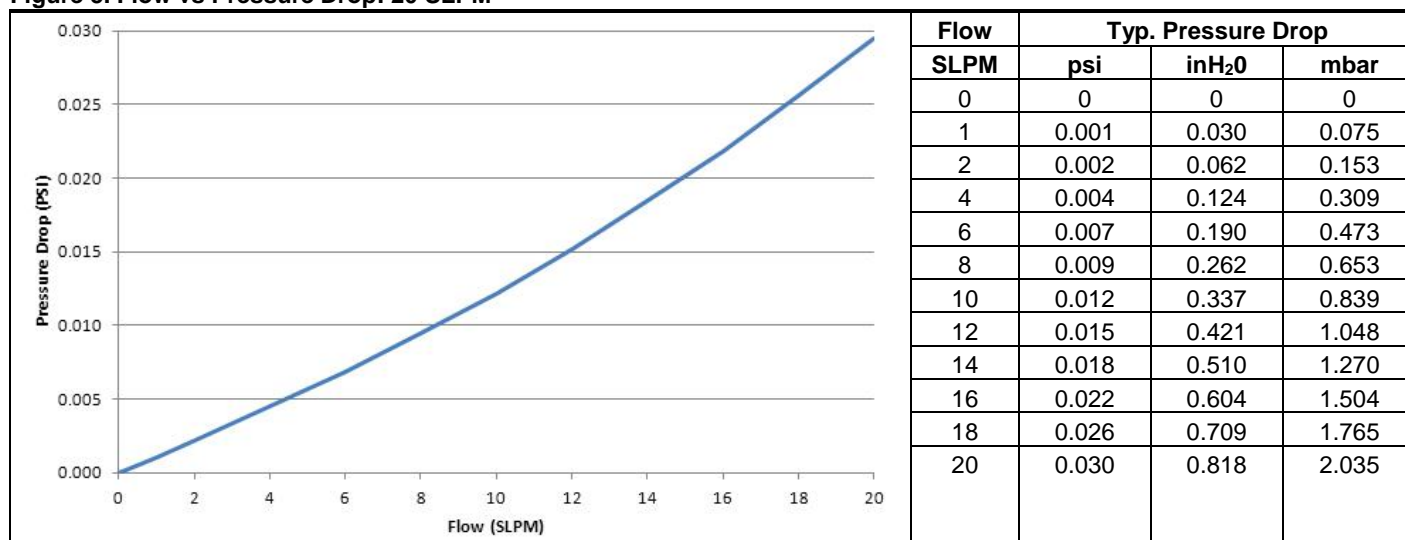
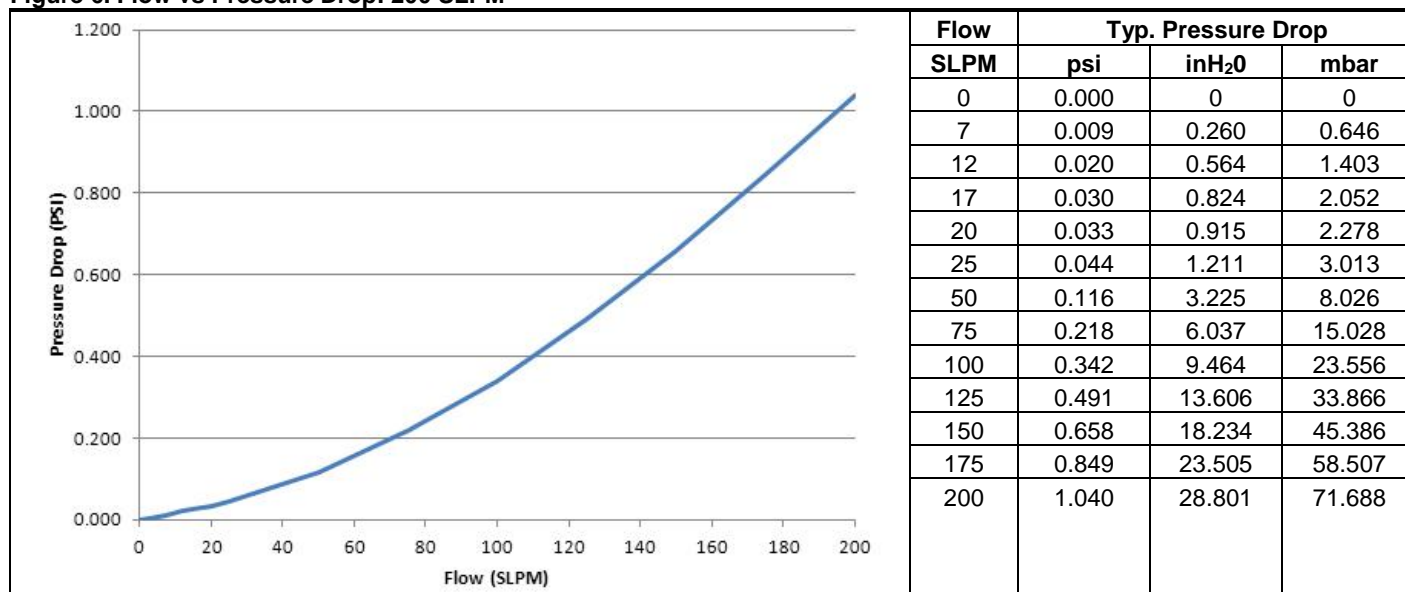

Figure 6. Flow vs Pressure Drop: 200 SLPM



Digital Interface

For additional details on the use of Zephyr with digital output see the Technical Note [“I²C Communications with Honeywell Digital Airflow Sensors”](#).

The sensor uses the I²C standard for digital communication with a slave address specified in the Nomenclature and Order Guide in Figure 1. Following sensor power-up, each of the first two read sequences shown in Figure 7 will respond with 2 bytes of the unique 4-byte Serial Number. The first read after power-up will respond with the two most significant bytes of the Serial Number, while the second read will respond with the two least significant bytes of the Serial Number. For reliable performance, allow sensor to be powered for the sensor startup time before performing the first read, then allow a 10 ms command response time before performing the second read.

Honeywell Zephyr™ Digital Airflow Sensors

HAF Series—High Accuracy

Figure 7. Sensor I²C Read and Write Sequences

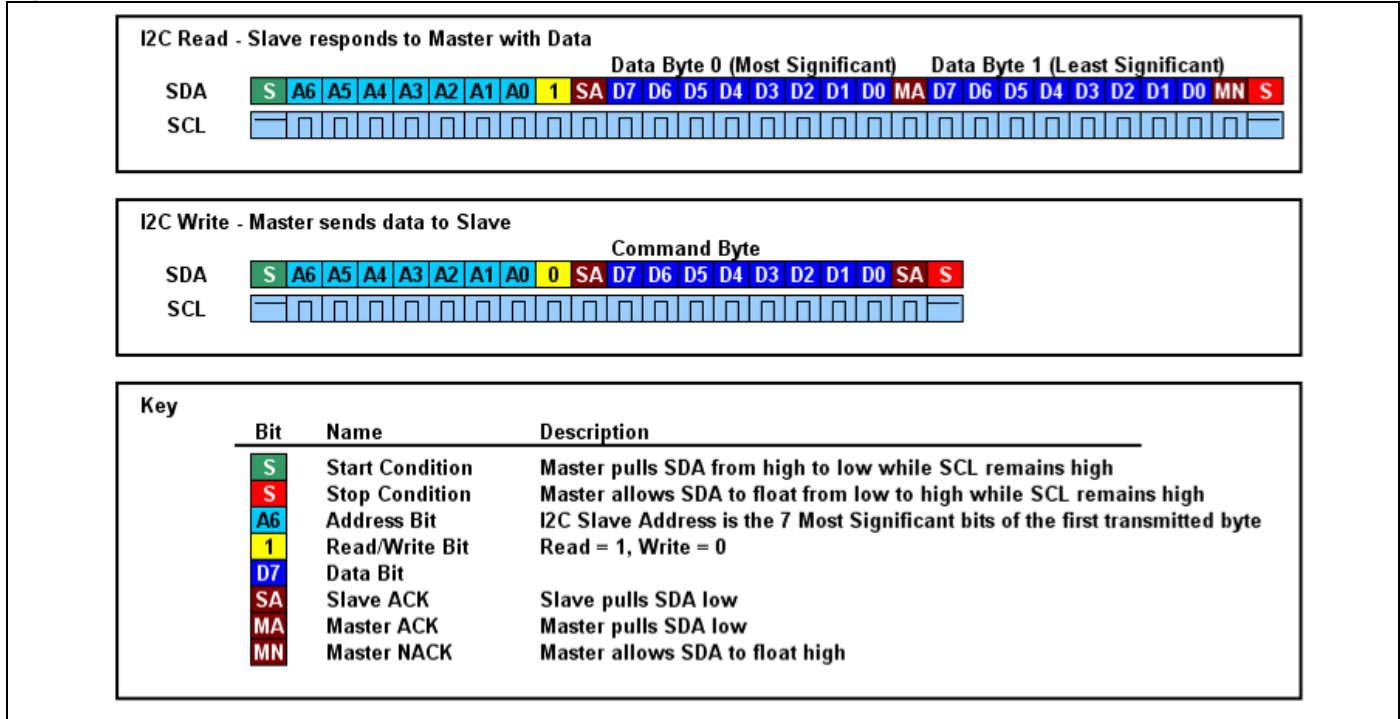

After the power-up read sequence described above, the sensor will respond to each I²C read request with a 16-bit (2 byte) digital flow reading. Read requests taken faster than the Response Time (1 ms) are not guaranteed to return fresh data. The first two bits of each flow reading will be '00', while non-flow responses (such as error and status codes) will begin with '11'.

There are several user commands available as shown in Table 8. Following an I²C write sequence of a user command, the sensor will respond to the next I²C read request with a 16-bit response. Possible responses to user commands can be seen in Table 9.

Table 8. User Command Descriptions

Command Byte (Hexadecimal)	Command Name	Command Description	Command Response Time (Max.)
0x01	GetSerialNumber	Next two read requests will each return two bytes of the sensor's unique 4-byte Serial Number.	10 ms
0x02	PowerOnReset	Force Power-On reset of sensor microcontroller.	20 ms
0x03	Checksum	Calculates EEPROM Checksum and compares to production Checksum value. If the values match, the next read request will respond with 0xCCA5. Otherwise, the next read will respond with 0xCC90.	1 s

Table 9. Sensor Response Descriptions

Sensor Response (Hexadecimal)	Response Name	Response Description
0xCCA5	POSACK	non-response command was executed successfully
0xCC99	BadCommand	command byte was not recognized
0xCC9A	BadParam	command sent with incorrect parameter bytes
0xCC9B	Failure	command failed during execution
0xCC90	BadChecksum	checksum did not match stored value
0xCCBB	Busy	sensor is busy calculating the checksum value

20 SLPM or 200 SLPM

The maximum sink current on SCL or SDA is 2 mA. Therefore, if the pull-up resistors are biased by V_{DD} , and if V_{DD} reaches the maximum supply voltage of 6 V, then the pull-up resistors for SCL and SDA must be greater than 3.0 k Ω to limit the sink current to 2 mA. The typical value for SCL and SDA pull-up resistors is 4.7 k Ω (this value depends on the bus capacitance and the bus speed).

Figure 8. Mounting Dimensions (For reference only: mm [in]).

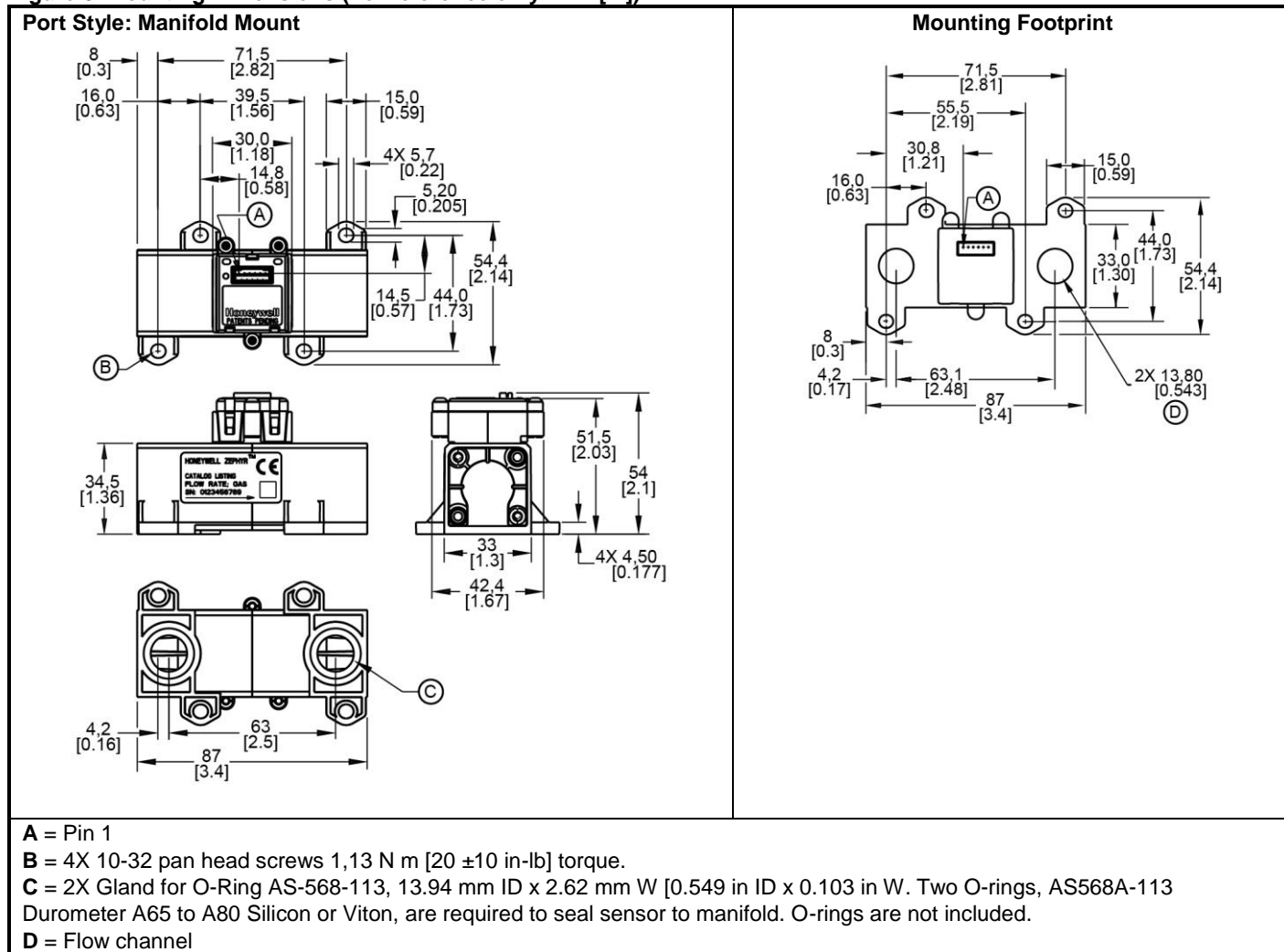

Honeywell Zephyr™ Digital Airflow Sensors HAF Series—High Accuracy

Figure 8. Mounting Dimensions (For reference only: mm [in], continued.)

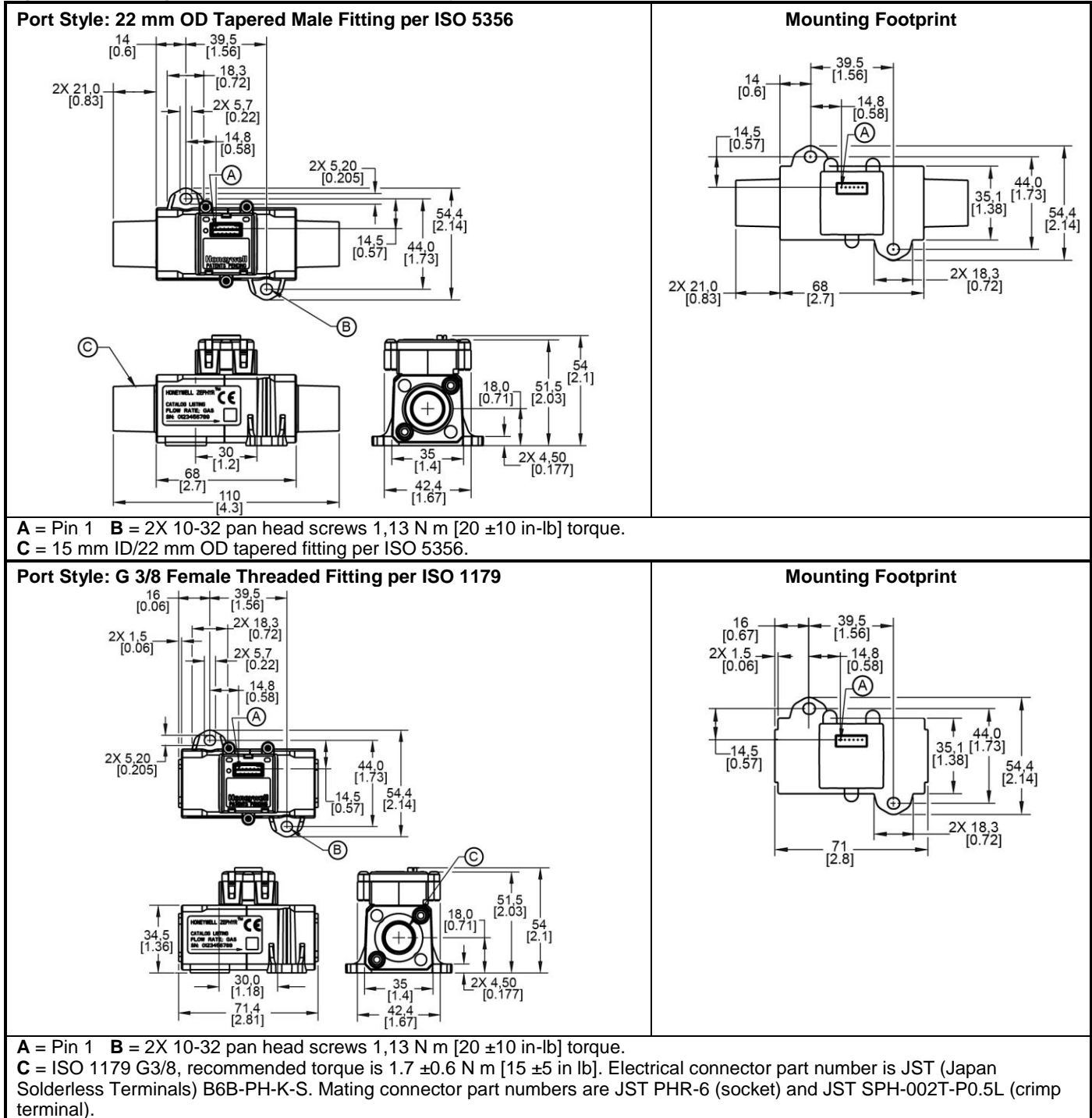

Table 10. Pinout (Digital Function)

Pin 1	Pin 2	Pin 3	Pin 4	Pin 5	Pin 6
NC	SCL	Vdd	ground	SDA	NC

⚠ WARNING

PERSONAL INJURY

DO NOT USE these products as safety or emergency stop devices or in any other application where failure of the product could result in personal injury.

Failure to comply with these instructions could result in death or serious injury.

WARRANTY/REMEDY

Honeywell warrants goods of its manufacture as being free of defective materials and faulty workmanship. Honeywell's standard product warranty applies unless agreed to otherwise by Honeywell in writing; please refer to your order acknowledgement or consult your local sales office for specific warranty details. If warranted goods are returned to Honeywell during the period of coverage, Honeywell will repair or replace, at its option, without charge those items it finds defective. **The foregoing is buyer's sole remedy and is in lieu of all other warranties, expressed or implied, including those of merchantability and fitness for a particular purpose. In no event shall Honeywell be liable for consequential, special, or indirect damages.**

While we provide application assistance personally, through our literature and the Honeywell web site, it is up to the customer to determine the suitability of the product in the application.

Specifications may change without notice. The information we supply is believed to be accurate and reliable as of this printing. However, we assume no responsibility for its use.

⚠ WARNING

MISUSE OF DOCUMENTATION

- The information presented in this product sheet is for reference only. Do not use this document as a product installation guide.
- Complete installation, operation, and maintenance information is provided in the instructions supplied with each product.

Failure to comply with these instructions could result in death or serious injury.

SALES AND SERVICE

Honeywell serves its customers through a worldwide network of sales offices, representatives and distributors. For application assistance, current specifications, pricing or name of the nearest Authorized Distributor, contact your local sales office or:

E-mail: info.sc@honeywell.com

Internet: sensing.honeywell.com

Phone and Fax:

Asia Pacific	+65 6355-2828
	+65 6445-3033 Fax
Europe	+44 (0) 1698 481481
	+44 (0) 1698 481676 Fax
Latin America	+1-305-805-8188
	+1-305-883-8257 Fax
USA/Canada	+1-800-537-6945
	+1-815-235-6847
	+1-815-235-6545 Fax

Sensing and Control
Honeywell
1985 Douglas Drive North
Golden Valley, MN 55422
sensing.honeywell.com

008267-3-EN
February 2013
© 2013 Honeywell International Inc. All rights reserved.

Honeywell