

# LM4880 Boomer® Audio Power Amplifier Series **Dual 250 mW Audio Power Amplifier with Shutdown Mode**

Check for Samples: [LM4880](#)

## FEATURES

- **No Bootstrap Capacitors or Snubber Circuits are Necessary**
- **Small Outline (SOIC) and PDIP Packaging**
- **Unity-Gain Stable**
- **External Gain Configuration Capability**

## APPLICATIONS

- **Headphone Amplifier**
- **Personal Computers**
- **CD-ROM Players**

## KEY SPECIFICATIONS

- **THD+N at 1kHz at 200mW Continuous Average Output Power into 8Ω: 0.1% (max)**
- **THD+N at 1kHz at 85mW Continuous Average Output Power into 32Ω: 0.1% (typ)**
- **Output Power at 10% THD+N at 1kHz into 8Ω 325 mW (typ)**
- **Shutdown Current 0.7 μA (typ)**
- **2.7V to 5.5V Supply Voltage Range**

## Connection Diagram

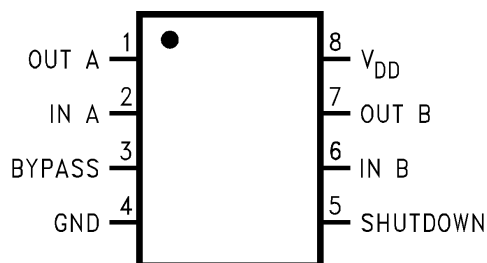

**Figure 1. Small Outline and PDIP Packages- Top View**  
**See Package Number D0008A for SOIC**  
**or Package Number P0008E for PDIP**

## DESCRIPTION

The LM4880 is a dual audio power amplifier capable of delivering typically 250mW per channel of continuous average power to an 8Ω load with 0.1% THD+N using a 5V power supply.

Boomer audio power amplifiers were designed specifically to provide high quality output power with a minimal amount of external components using surface mount packaging.

Since the LM4880 does not require bootstrap capacitors or snubber networks, it is optimally suited for low-power portable systems.

The LM4880 features an externally controlled, low-power consumption shutdown mode, as well as an internal thermal shutdown protection mechanism.

The unity-gain stable LM4880 can be configured by external gain-setting resistors.



Please be aware that an important notice concerning availability, standard warranty, and use in critical applications of Texas Instruments semiconductor products and disclaimers thereto appears at the end of this data sheet.

All trademarks are the property of their respective owners.

## Typical Application

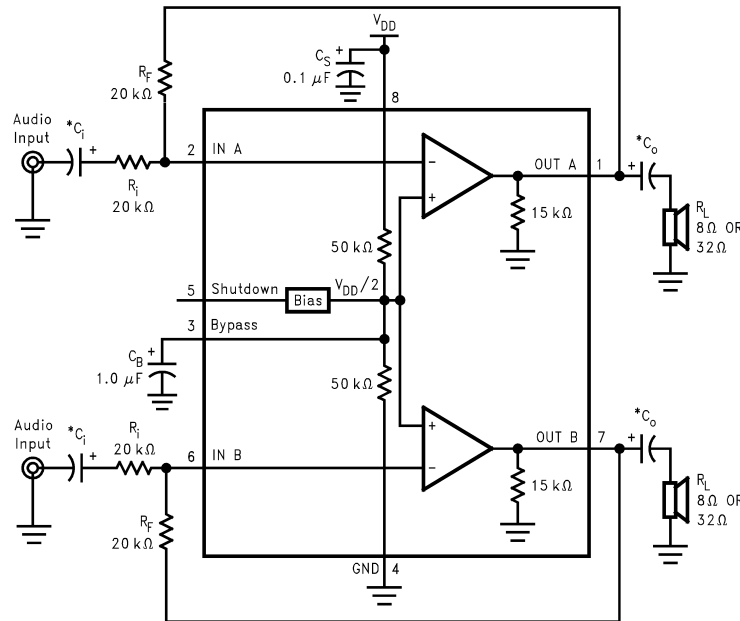

\*Refer to [Application Information](#) for information concerning proper selection of the input and output coupling capacitors.

**Figure 2. Typical Audio Amplifier Application Circuit**



These devices have limited built-in ESD protection. The leads should be shorted together or the device placed in conductive foam during storage or handling to prevent electrostatic damage to the MOS gates.

## Absolute Maximum Ratings <sup>(1)(2)</sup>

Supply Voltage			6.0V
Storage Temperature			-65°C to +150°C
Input Voltage			-0.3V to $V_{DD} + 0.3V$
Power Dissipation <sup>(3)</sup>			Internally limited
ESD Susceptibility <sup>(4)</sup>			2000V
ESD Susceptibility <sup>(5)</sup>			200V
Junction Temperature			150°C
Soldering Information	Small Outline Package	Vapor Phase (60 sec.)	215°C
		Infrared (15 sec.)	220°C
Thermal Resistance		$\theta_{JC}$ (PDIP)	37°C/W
		$\theta_{JA}$ (PDIP)	107°C/W
		$\theta_{JC}$ (SOIC)	35°C/W
		$\theta_{JA}$ (SOIC)	170°C/W

- (1) Absolute Maximum Ratings indicate limits beyond which damage may occur. Operating Ratings indicate conditions for which the device is functional, but do not specify specific performance limits. Electrical Characteristics state DC and AC electrical specifications under particular test conditions which ensure specific performance limits. This assumes that the device is within the Operating Ratings. Specifications are not specified for parameters where no limit is given, however, the typical value is a good indication of device performance.
- (2) If Military/Aerospace specified devices are required, please contact the Texas Instruments Sales Office/ Distributors for availability and specifications.
- (3) The maximum power dissipation must be derated at elevated temperatures and is dictated by  $T_{JMAX}$ ,  $\theta_{JA}$ , and the ambient temperature  $T_A$ . The maximum allowable power dissipation is  $P_{DMAX} = (T_{JMAX} - T_A)/\theta_{JA}$  or the number given in the Absolute Maximum Ratings, whichever is lower. For the LM4880,  $T_{JMAX} = 150^\circ\text{C}$ , and the typical junction-to-ambient thermal resistance is 170°C/W for package D0008A and 107°C/W for package P0008E.
- (4) Human body model, 100 pF discharged through a 1.5 kΩ resistor.
- (5) Machine model, 220 pF–240 pF discharged through all pins.

## Operating Ratings

Temperature Range	$T_{MIN} \leq T_A \leq T_{MAX}$	$-40^{\circ}\text{C} \leq T_A \leq +85^{\circ}\text{C}$
Supply Voltage		$2.7\text{V} \leq V_{DD} \leq 5.5\text{V}$

## Electrical Characteristics (1)(2)

The following specifications apply for  $V_{DD} = 5\text{V}$  unless otherwise specified. Limits apply for  $T_A = 25^{\circ}\text{C}$ .

Symbol	Parameter	Conditions	LM4880		Units (Limits)
			Typical	Limit	
			(3)	(4)	
$V_{DD}$	Supply Voltage			2.7 5.5	V (min) V (max)
$I_{DD}$	Quiescent Power Supply Current	$V_{IN}=0\text{V}, I_O=0\text{A}$	3.6	6.0	mA (max)
$I_{SD}$	Shutdown Current	$V_{PINS}=V_{DD}$	0.7	5	$\mu\text{A}$ (max)
$V_{OS}$	Output Offset Voltage	$V_{IN}=0\text{V}$	5	50	mV (max)
$P_O$	Output Power	THD=0.1% (max); f=1 kHz; $R_L=8\Omega$ $R_L=32\Omega$ THD+N=10%; f=1 kHz $R_L=8\Omega$ $R_L=32\Omega$	250 85	200	mW (min) mW
THD+N	Total Harmonic Distortion+Noise	$R_L=8\Omega, P_O=200\text{ mW};$ $R_L=32\Omega, P_O=75\text{ mW};$ f=1 kHz	0.03 0.02		% %
PSRR	Power Supply Rejection Ratio	$C_B = 1.0\ \mu\text{F},$ $V_{RIPPLE}=200\text{ mVrms}, f = 100\text{ Hz}$	50		dB

- (1) All voltages are measured with respect to the ground pin, unless otherwise specified.
- (2) Absolute Maximum Ratings indicate limits beyond which damage may occur. Operating Ratings indicate conditions for which the device is functional, but do not specify specific performance limits. Electrical Characteristics state DC and AC electrical specifications under particular test conditions which ensure specific performance limits. This assumes that the device is within the Operating Ratings. Specifications are not specified for parameters where no limit is given, however, the typical value is a good indication of device performance.
- (3) Typicals are measured at  $25^{\circ}\text{C}$  and represent the parametric norm.
- (4) Limits are ensured to TI's AOQL (Average Outgoing Quality Level).

### Automatic Shutdown Circuit

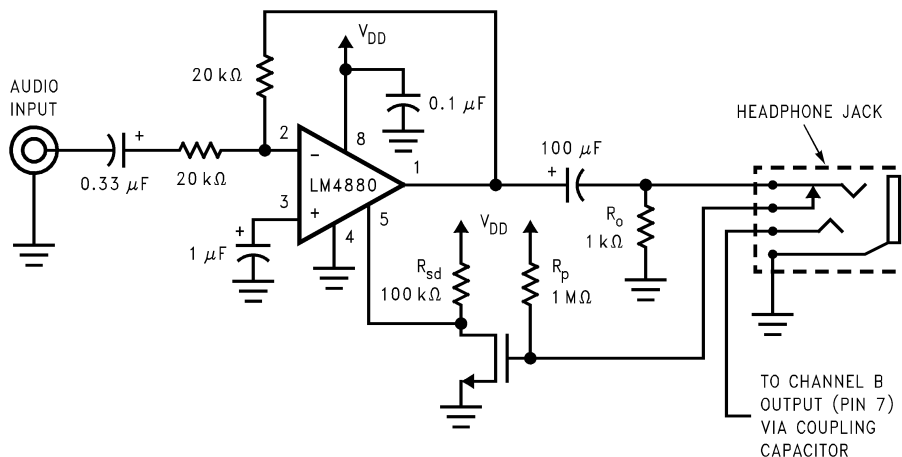

Figure 3. Automatic Shutdown Circuit

## Automatic Switching Circuit

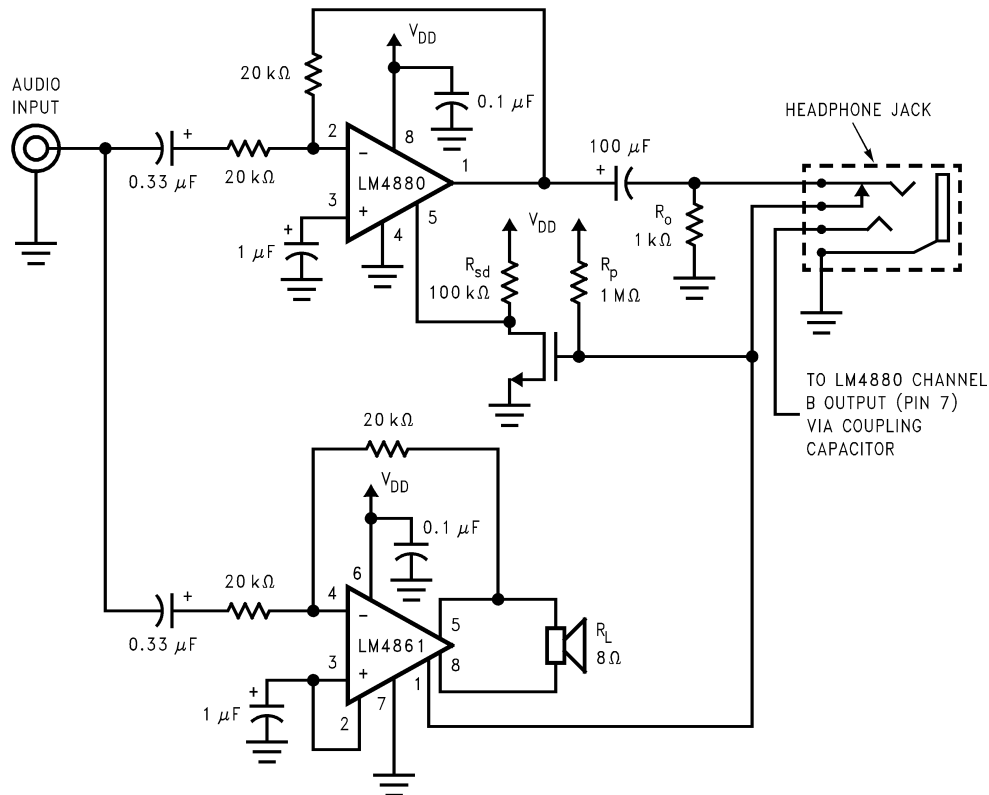

Figure 4. Automatic Switching Circuit

## External Components Description

(Figure 2)

Components	Functional Description
1. $R_i$	Inverting input resistance which sets the closed-loop gain in conjunction with $R_F$ . This resistor also forms a high pass filter with $C_i$ at $f_c = 1/(2\pi R_i C_i)$ .
2. $C_i$	Input coupling capacitor which blocks the DC voltage at the amplifier's input terminals. Also creates a high pass filter with $R_i$ at $f_c = 1/(2\pi R_i C_i)$ . Refer to <a href="#">PROPER SELECTION OF EXTERNAL COMPONENTS</a> for an explanation of how to determine the value of $C_i$ .
3. $R_F$	Feedback resistance which sets closed-loop gain in conjunction with $R_i$ .
4. $C_S$	Supply bypass capacitor which provides power supply filtering. Refer to <a href="#">Application Information</a> for proper placement and selection of the supply bypass capacitor.
5. $C_B$	Bypass pin capacitor which provides half-supply filtering. Refer to <a href="#">PROPER SELECTION OF EXTERNAL COMPONENTS</a> for information concerning proper placement and selection of $C_B$ .
6. $C_o$	Output coupling capacitor which blocks the DC voltage at the amplifier's output. Forms a high pass filter with $R_L$ at $f_o = 1/(2\pi R_L C_o)$ .

Typical Performance Characteristics

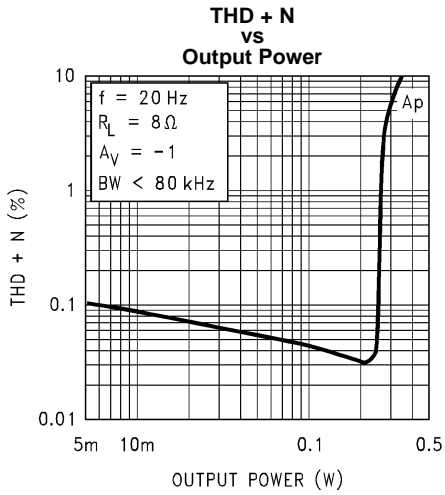

Figure 5.

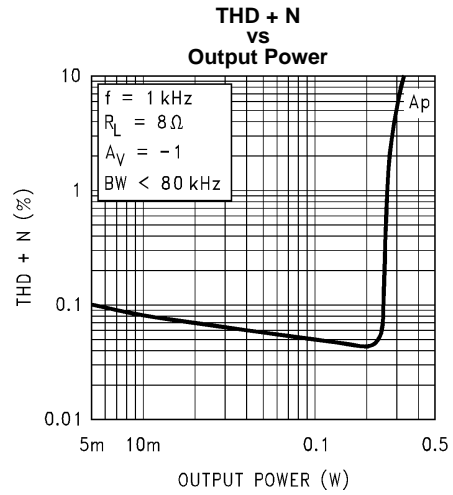

Figure 6.

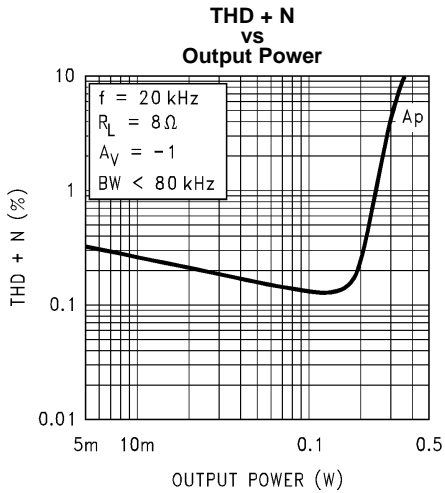

Figure 7.

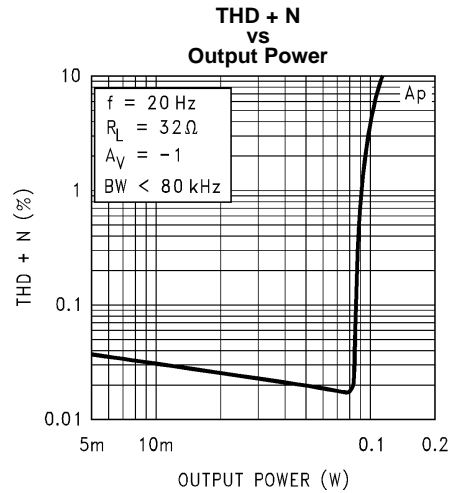

Figure 8.

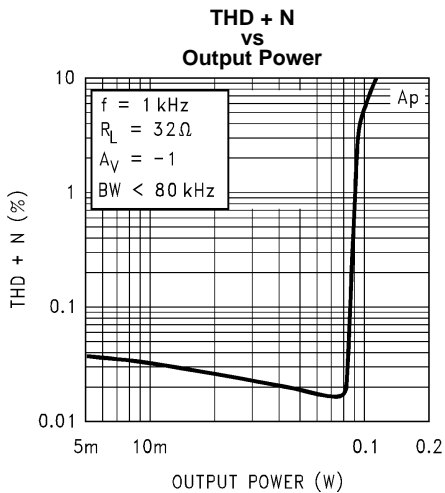

Figure 9.

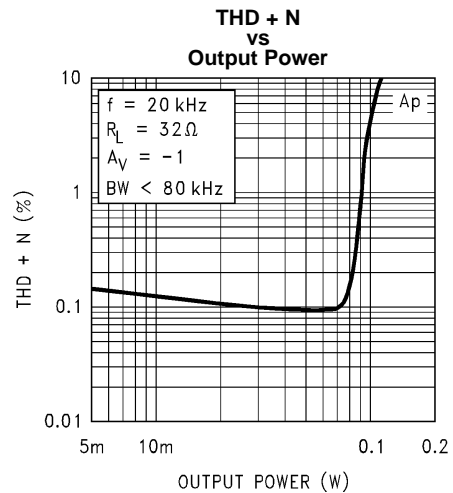

Figure 10.

Typical Performance Characteristics (continued)

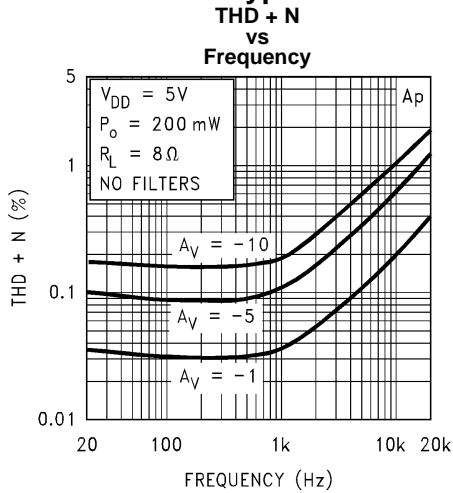

Figure 11.

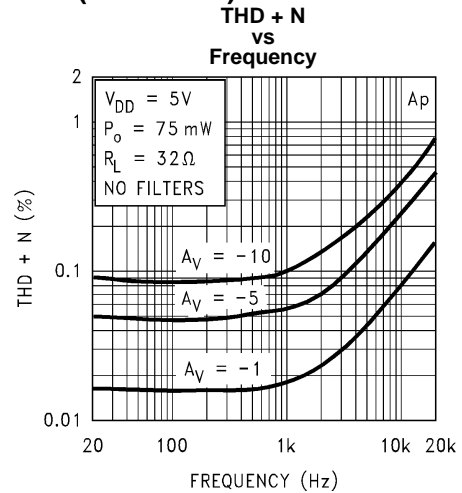

Figure 12.

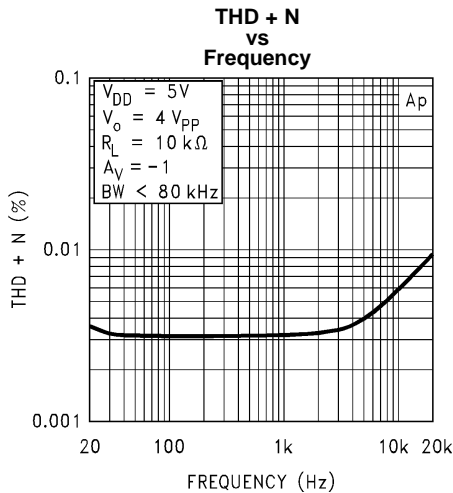

Figure 13.

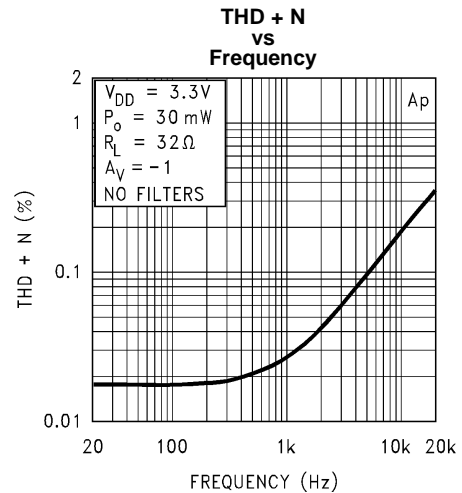

Figure 14.

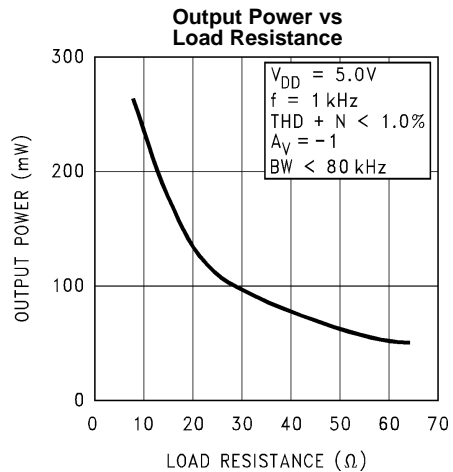

Figure 15.

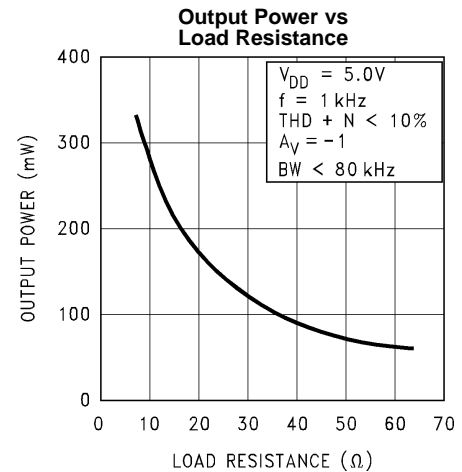

Figure 16.

Typical Performance Characteristics (continued)

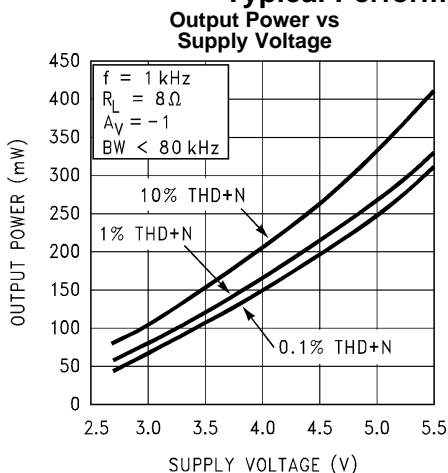

Figure 17.

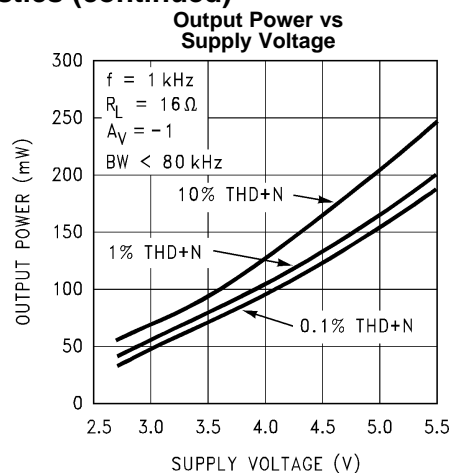

Figure 18.

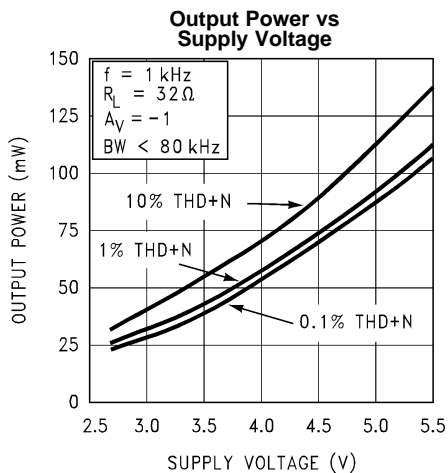

Figure 19.

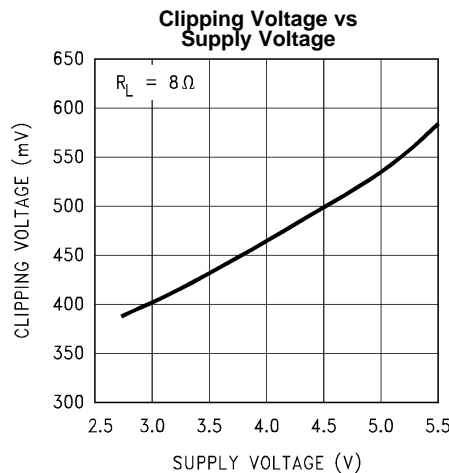

Figure 20.

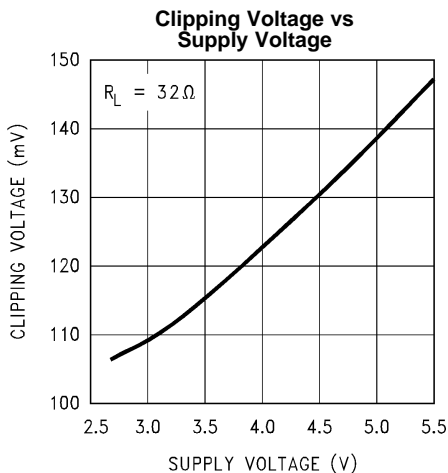

Figure 21.

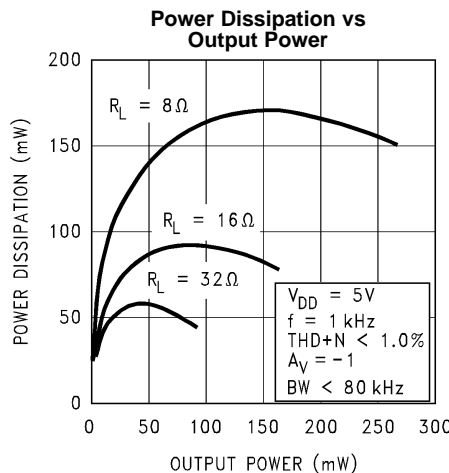

Figure 22.

Typical Performance Characteristics (continued)

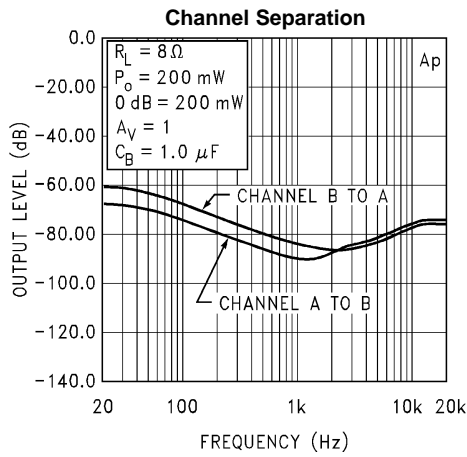

Figure 23.

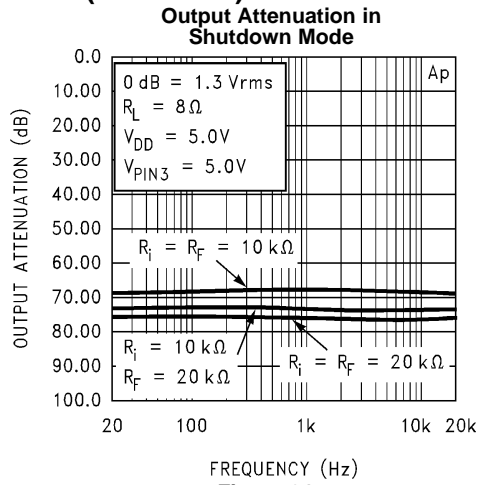

Figure 24.

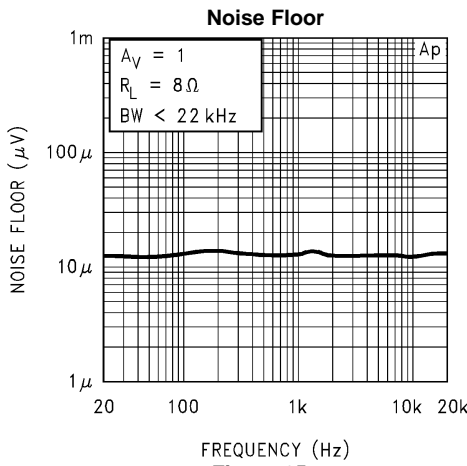

Figure 25.

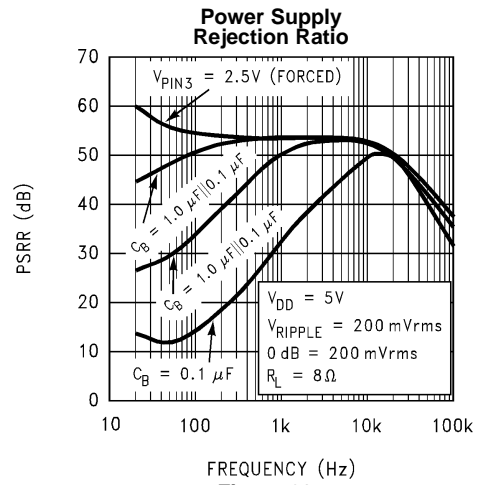

Figure 26.

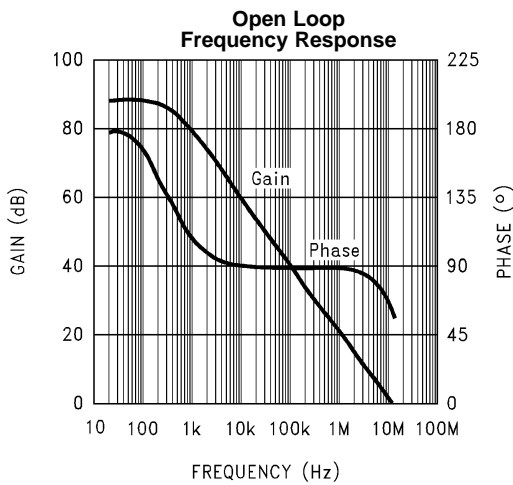

Figure 27.

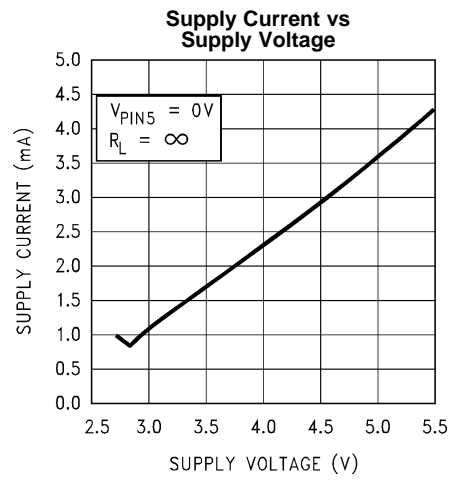
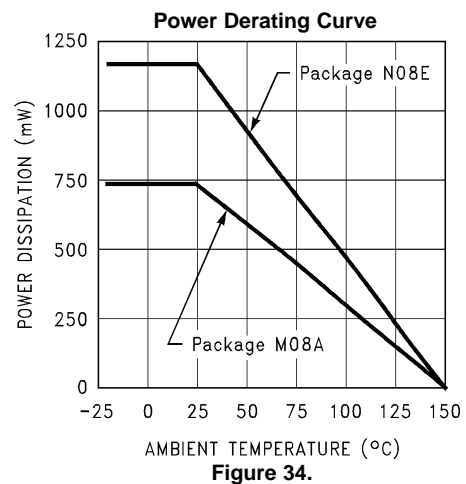
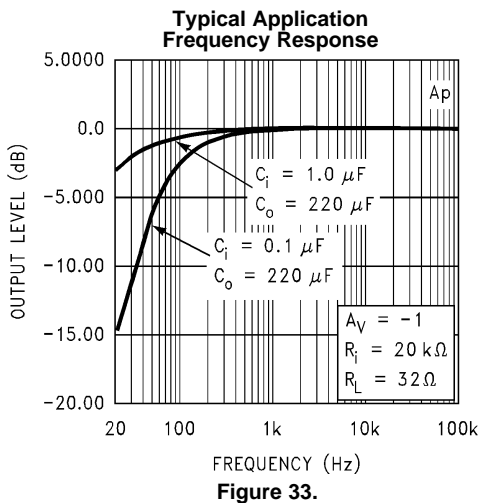
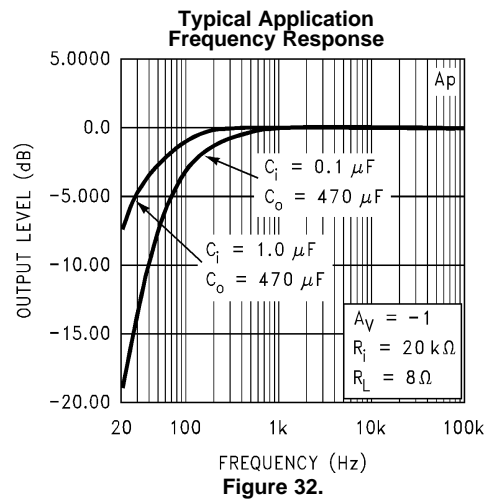
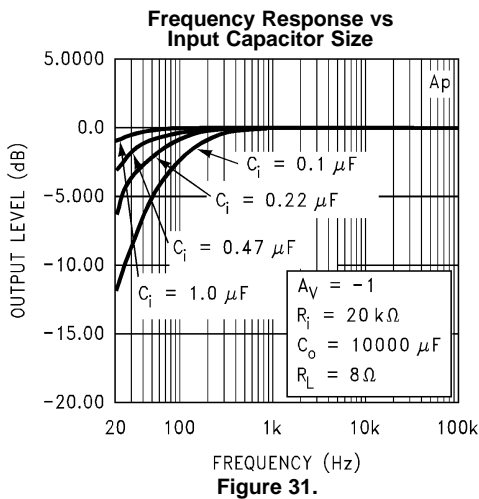
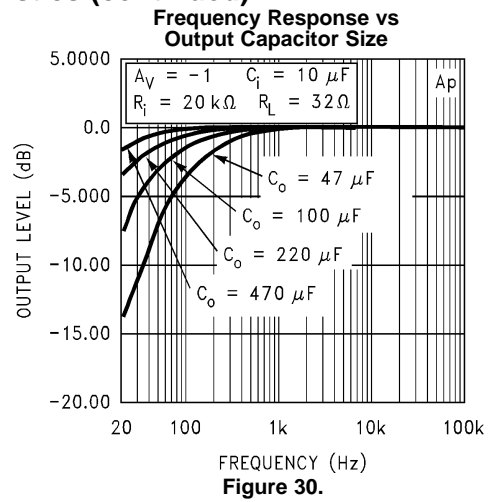
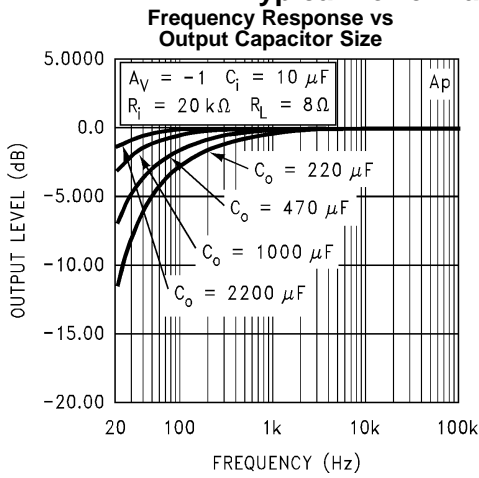

Figure 28.



Typical Performance Characteristics (continued)



## APPLICATION INFORMATION

### SHUTDOWN FUNCTION

In order to reduce power consumption while not in use, the LM4880 contains a shutdown pin to externally turn off the amplifier's bias circuitry. This shutdown feature turns the amplifier off when a logic high is placed on the shutdown pin. The trigger point between a logic low and logic high level is typically half supply. It is best to switch between ground and the supply to provide maximum device performance. By switching the shutdown pin to  $V_{DD}$ , the LM4880 supply current draw will be minimized in idle mode. While the device will be disabled with shutdown pin voltages less than  $V_{DD}$ , the idle current may be greater than the typical value of 0.7  $\mu\text{A}$ . In either case, the shutdown pin should be tied to a definite voltage because leaving the pin floating may result in an unwanted shutdown condition.

In many applications, a microcontroller or microprocessor output is used to control the shutdown circuitry which provides a quick, smooth transition into shutdown. Another solution is to use a single-pole, single-throw switch in conjunction with an external pull-up resistor. When the switch is closed, the shutdown pin is connected to ground and enables the amplifier. If the switch is open, then the external pull-up resistor will disable the LM4880. This scheme ensures that the shutdown pin will not float which will prevent unwanted state changes.

### POWER DISSIPATION

Power dissipation is a major concern when using any power amplifier and must be thoroughly understood to ensure a successful design. [Equation 1](#) states the maximum power dissipation point for a single-ended amplifier operating at a given supply voltage and driving a specified output load.

$$P_{\text{DMAX}} = (V_{\text{DD}})^2 / (2\pi^2 R_L) \quad (1)$$

Since the LM4880 has two operational amplifiers in one package, the maximum internal power dissipation point is twice that of the number which results from [Equation 1](#). Even with the large internal power dissipation, the LM4880 does not require heat sinking over a large range of ambient temperatures. From [Equation 1](#), assuming a 5V power supply and an 8 $\Omega$  load, the maximum power dissipation point is 158 mW per amplifier. Thus the maximum package dissipation point is 317 mW. The maximum power dissipation point obtained must not be greater than the power dissipation that results from [Equation 2](#):

$$P_{\text{DMAX}} = (T_{\text{JMAX}} - T_A) / \theta_{\text{JA}} \quad (2)$$

For the LM4880 surface mount package,  $\theta_{\text{JA}} = 170^\circ \text{C/W}$  and  $T_{\text{JMAX}} = 150^\circ\text{C}$ . Depending on the ambient temperature,  $T_A$ , of the system surroundings, [Equation 2](#) can be used to find the maximum internal power dissipation supported by the IC packaging. If the result of [Equation 1](#) is greater than that of [Equation 2](#), then either the supply voltage must be decreased, the load impedance increased, or the ambient temperature reduced. For the typical application of a 5V power supply, with an 8 $\Omega$  load, the maximum ambient temperature possible without violating the maximum junction temperature is approximately 96 $^\circ\text{C}$  provided that device operation is around the maximum power dissipation point. Power dissipation is a function of output power and thus, if typical operation is not around the maximum power dissipation point, the ambient temperature may be increased accordingly. Refer to [Typical Performance Characteristics](#) for power dissipation information for lower output powers.

### POWER SUPPLY BYPASSING

As with any power amplifier, proper supply bypassing is critical for low noise performance and high power supply rejection. The capacitor location on both the bypass and power supply pins should be as close to the device as possible. As displayed in [Typical Performance Characteristics](#), the effect of a larger half supply bypass capacitor is improved low frequency PSRR due to increased half-supply stability. Typical applications employ a 5V regulator with 10  $\mu\text{F}$  and a 0.1  $\mu\text{F}$  bypass capacitors which aid in supply stability, but do not eliminate the need for bypassing the supply nodes of the LM4880. The selection of bypass capacitors, especially  $C_B$ , is thus dependant upon desired low frequency PSRR, click and pop performance as explained in [PROPER SELECTION OF EXTERNAL COMPONENTS](#), system cost, and size constraints.

## AUTOMATIC SHUTDOWN CIRCUIT

As shown in [Figure 3](#), the LM4880 can be set up to automatically shutdown when a load is not connected. This circuit is based upon a single control pin common in many headphone jacks. This control pin forms a normally closed switch with one of the output pins. The output of this circuit (the voltage on pin 5 of the LM4880) has two states based on the state of the switch. When the switch is open, signifying that headphones are inserted, the LM4880 should be enabled. When the switch is closed, the LM4880 should be off to minimize power consumption.

The operation of this circuit is rather simple. With the switch closed,  $R_p$  and  $R_o$  form a resistor divider which produces a gate voltage of less than 5 mV. This gate voltage keeps the NMOS inverter off and  $R_{sd}$  pulls the shutdown pin of the LM4880 to the supply voltage. This places the LM4880 in shutdown mode which reduces the supply current to 0.7  $\mu$ A typically. When the switch is open, the opposite condition is produced. Resistor  $R_p$  pulls the gate of the NMOS high which turns on the inverter and produces a logic low signal on the shutdown pin of the LM4880. This state enables the LM4880 and places the amplifier in its normal mode of operation.

This type of circuit is clearly valuable in portable products where battery life is critical, but is also beneficial for power conscious designs such as “Green PC’s”.

## AUTOMATIC SWITCHING CIRCUIT

A circuit closely related to [Automatic Shutdown Circuit](#) is [Automatic Switching Circuit](#). [Automatic Switching Circuit](#) utilizes both the input and output of the NMOS inverter to toggle the states of two different audio power amplifiers. The LM4880 is used to drive stereo single ended loads, while the LM4861 drives bridged internal speakers.

In this application, the LM4880 and LM4861 are never on at the same time. When the switch inside the headphone jack is open, the LM4880 is enabled and the LM4861 is disabled since the NMOS inverter is on. If a headphone jack is not present, it is assumed that the internal speakers should be on and thus the voltage on the LM4861 shutdown pin is low and the voltage at the LM4880 pin is high. This results in the LM4880 being shutdown and the LM4861 being enabled.

Only one channel of this circuit is shown in [Figure 4](#) to keep the drawing simple but the typical application would a LM4880 driving a stereo external headphone jack and two LM4861's driving the internal stereo speakers. If only one internal speaker is required, a single LM4861 can be used as a summer to mix the left and right inputs into a single mono channel.

## PROPER SELECTION OF EXTERNAL COMPONENTS

Selection of external components when using integrated power amplifiers is critical to optimize device and system performance. While the LM4880 is tolerant of external component combinations, care must be exercised when choosing component values.

The LM4880 is unity-gain stable which gives a designer maximum system flexibility. The LM4880 should be used in low gain configurations to minimize THD + N values, and maximize the signal to noise ratio. Low gain configurations require large input signals to obtain a given output power. Input signals equal to or greater than 1 V<sub>rms</sub> are available from sources such as audio codecs. Please refer to [AUDIO POWER AMPLIFIER DESIGN](#) for a more complete explanation of proper gain selection.

Besides gain, one of the major design considerations is the closed-loop bandwidth of the amplifier. To a large extent, the bandwidth is dictated by the choice of external components shown in [Figure 2](#). Both the input coupling capacitor,  $C_i$ , and the output coupling capacitor,  $C_o$ , form first order high pass filters which limit low frequency response. These values should be chosen based on needed frequency response for a few distinct reasons.

### Selection of Input and Output Capacitor Size

Large input and output capacitors are both expensive and space hungry for portable designs. Clearly a certain sized capacitor is needed to couple in low frequencies without severe attenuation. But in many cases the transducers used in portable systems, whether internal or external, have little ability to reproduce signals below 100 Hz–150 Hz. Thus using large input and output capacitors may not increase system performance.

In addition to system cost and size, click and pop performance is effected by the size of the input coupling capacitor,  $C_i$ . A larger input coupling capacitor requires more charge to reach its quiescent DC voltage (normally  $1/2 V_{DD}$ .) This charge comes from the output via the feedback and is apt to create pops upon device enable. Thus, by minimizing the capacitor size based on necessary low frequency response, turn-on pops can be minimized.

Besides minimizing the input and output capacitor sizes, careful consideration should be paid to the bypass capacitor size. The bypass capacitor,  $C_B$ , is the most critical component to minimize turn-on pops since it determines how fast the LM4880 turns on. The slower the LM4880's outputs ramp to their quiescent DC voltage (nominally  $1/2 V_{DD}$ ), the smaller the turn-on pop. Choosing  $C_B$  equal to  $1.0 \mu\text{F}$  along with a small value of  $C_i$  (in the range of  $0.1 \mu\text{F}$  to  $0.39 \mu\text{F}$ ), should produce a virtually clickless and popless shutdown function. While the device will function properly, (no oscillations or motorboating), with  $C_B$  equal to  $0.1 \mu\text{F}$ , the device will be much more susceptible to turn-on clicks and pops. Thus, a value of  $C_B$  equal to  $1.0 \mu\text{F}$  or larger is recommended in all but the most cost sensitive designs.

## AUDIO POWER AMPLIFIER DESIGN

### Design a Dual 200 mW/8Ω Audio Amplifier

Given:

Power Output: 200 mWrms

Load Impedance:  $8\Omega$

Input Level: 1 Vrms (max)

Input Impedance:  $20\text{ k}\Omega$

Bandwidth: 100 Hz–20 kHz  $\pm$  0.50 dB

A designer must first determine the needed supply rail to obtain the specified output power. Calculating the required supply rail involves knowing two parameters,  $V_{\text{opeak}}$  and also the dropout voltage. As shown in [Typical Performance Characteristics](#), the dropout voltage is typically  $0.5V$ .  $V_{\text{opeak}}$  can be determined from [Equation 3](#).

$$V_{\text{opeak}} = \sqrt{(2R_L P_o)} \quad (3)$$

For 200 mW of output power into an  $8\Omega$  load, the required  $V_{\text{opeak}}$  is 1.79V. Since this is a single supply application, the minimum supply voltage is twice the sum of  $V_{\text{opeak}}$  and  $V_{\text{od}}$ . Since 5V is a standard supply voltage in most applications, it is chosen for the supply rail. Extra supply voltage creates headroom that allows the LM4880 to reproduce peaks in excess of 200 mW without clipping the signal. At this time, the designer must make sure that the power supply choice along with the output impedance does not violate the conditions explained in [POWER DISSIPATION](#). Remember that the maximum power dissipation value from [Equation 1](#) must be multiplied by two since there are two independent amplifiers inside the package.

Once the power dissipation equations have been addressed, the required gain can be determined from [Equation 4](#).

$$|A_V| \geq \sqrt{(P_o R_L)} / (V_{IN}) = V_{\text{orms}} / V_{\text{inrms}} \quad (4)$$

$$A_V = -R_f / R_i \quad (5)$$

From [Equation 4](#), the minimum gain is:  $A_V = -1.26$

Since the desired input impedance was  $20\text{ k}\Omega$ , and with a gain of  $-1.26$ , a value of  $27\text{ k}\Omega$  is designated for  $R_f$ , assuming 5% tolerance resistors. This combination results in a nominal gain of  $-1.35$ . The final design step is to address the bandwidth requirements which must be stated as a pair of  $-3\text{ dB}$  frequency points. Five times away from a  $-3\text{ dB}$  point is 0.17 dB down from passband response assuming a single pole roll-off. As stated in [External Components Description](#), both  $R_i$  in conjunction with  $C_i$ , and  $C_o$  with  $R_L$ , create first order high pass filters. Thus to obtain the desired frequency low response of 100 Hz within  $\pm 0.5\text{ dB}$ , both poles must be taken into consideration. The combination of two single order filters at the same frequency forms a second order response. This results in a signal which is down 0.34 dB at five times away from the single order filter  $-3\text{ dB}$  point. Thus, a frequency of 20 Hz is used in the following equations to ensure that the response is better than 0.5 dB down at 100 Hz.

$$C_i \geq 1 / (2\pi * 20\text{ k}\Omega * 20\text{ Hz}) = 0.397 \mu\text{F}; \text{ use } 0.39 \mu\text{F}$$

$C_o \geq 1/(2\pi \cdot 8\Omega \cdot 20\text{Hz}) = 995 \mu\text{F}$ ; use 1000  $\mu\text{F}$

The high frequency pole is determined by the product of the desired high frequency pole,  $f_H$ , and the closed-loop gain,  $A_V$ . With a closed-loop gain magnitude of 1.35 and  $f_H = 100 \text{ kHz}$ , the resulting GBWP = 135 kHz which is much smaller than the LM4880 GBWP of 12.5 MHz. This figure displays that if a designer has a need to design an amplifier with a higher gain, the LM4880 can still be used without running into bandwidth limitations.

**LM4880 MDA MWA  
DUAL 250 MW AUDIO POWER AMPLIFIER WITH SHUTDOWN MODE**

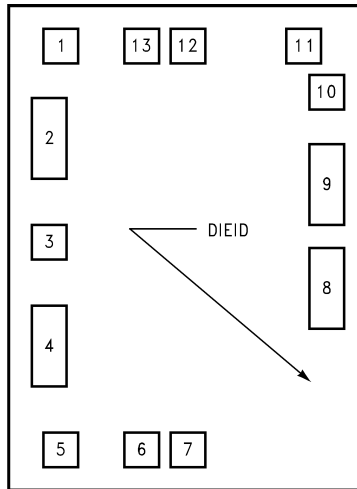

Figure 35. Die Layout (B - Step)

Table 1. Die/Wafer Characteristics

Fabrication Attributes		General Die Information	
Physical Die Identification	LM4880B	Bond Pad Opening Size (min)	86 $\mu\text{m}$ x 86 $\mu\text{m}$
Die Step	B	Bond Pad Metalization	ALUMINUM
Physical Attributes		Passivation	NITRIDE
Wafer Diameter	150mm	Back Side Metal	Bare Back
Dise Size (Drawn)	952 $\mu\text{m}$ x 1283 $\mu\text{m}$ 37mils x 51mils	Back Side Connection	GND
Thickness	254 $\mu\text{m}$ Nominal		
Min Pitch	117 $\mu\text{m}$ Nominal		

**Special Assembly Requirements:**

**Note: Actual die size is rounded to the nearest micron.**

Die Bond Pad Coordinate Locations (B - Step)						
(Referenced to die center, coordinates in $\mu\text{m}$ ) NC = No Connection						
SIGNAL NAME	PAD# NUMBER	X/Y COORDINATES		PAD SIZE		
		X	Y	X		Y
BYPASS	1	-322	523	86	x	86
GND	2	-359	259	86	x	188
NC	3	-359	5	86	x	86
GND	4	-359	-259	86	x	188
SHUTDOWN	5	-323	-523	86	x	86
INPUT B	6	-109	-523	86	x	86
OUTPUT B	7	8	-523	86	x	86

VDD	8	358	-78	86	x	188
GND	9	358	141	86	x	188
OUTPUT A	10	359	406	86	x	86
INPUT A	11	323	523	86	x	86
NC	12	8	523	86	x	86
NC	13	-109	523	86	x	86

---

**REVISION HISTORY**

<b>Changes from Revision B (May 2013) to Revision C</b>	<b>Page</b>
<hr/> <ul style="list-style-type: none"><li>• Changed layout of National Data Sheet to TI format .....</li></ul>	<hr/> <a href="#">14</a>

## PACKAGING INFORMATION

Orderable Device	Status (1)	Package Type	Package Drawing	Pins	Package Qty	Eco Plan (2)	Lead/Ball Finish	MSL Peak Temp (3)	Op Temp (°C)	Top-Side Markings (4)	Samples
LM4880M	ACTIVE	SOIC	D	8	95	TBD	Call TI	Call TI	-40 to 85	LM 4880M	<a href="#">Samples</a>
LM4880M/NOPB	ACTIVE	SOIC	D	8	95	Green (RoHS & no Sb/Br)	CU SN	Level-1-260C-UNLIM	-40 to 85	LM 4880M	<a href="#">Samples</a>
LM4880MX/NOPB	ACTIVE	SOIC	D	8	2500	Green (RoHS & no Sb/Br)	CU SN	Level-1-260C-UNLIM	-40 to 85	LM 4880M	<a href="#">Samples</a>

(1) The marketing status values are defined as follows:

**ACTIVE:** Product device recommended for new designs.

**LIFEBUY:** TI has announced that the device will be discontinued, and a lifetime-buy period is in effect.

**NRND:** Not recommended for new designs. Device is in production to support existing customers, but TI does not recommend using this part in a new design.

**PREVIEW:** Device has been announced but is not in production. Samples may or may not be available.

**OBSOLETE:** TI has discontinued the production of the device.

(2) Eco Plan - The planned eco-friendly classification: Pb-Free (RoHS), Pb-Free (RoHS Exempt), or Green (RoHS & no Sb/Br) - please check <http://www.ti.com/productcontent> for the latest availability information and additional product content details.

**TBD:** The Pb-Free/Green conversion plan has not been defined.

**Pb-Free (RoHS):** TI's terms "Lead-Free" or "Pb-Free" mean semiconductor products that are compatible with the current RoHS requirements for all 6 substances, including the requirement that lead not exceed 0.1% by weight in homogeneous materials. Where designed to be soldered at high temperatures, TI Pb-Free products are suitable for use in specified lead-free processes.

**Pb-Free (RoHS Exempt):** This component has a RoHS exemption for either 1) lead-based flip-chip solder bumps used between the die and package, or 2) lead-based die adhesive used between the die and leadframe. The component is otherwise considered Pb-Free (RoHS compatible) as defined above.

**Green (RoHS & no Sb/Br):** TI defines "Green" to mean Pb-Free (RoHS compatible), and free of Bromine (Br) and Antimony (Sb) based flame retardants (Br or Sb do not exceed 0.1% by weight in homogeneous material)

(3) MSL, Peak Temp. -- The Moisture Sensitivity Level rating according to the JEDEC industry standard classifications, and peak solder temperature.

(4) Multiple Top-Side Markings will be inside parentheses. Only one Top-Side Marking contained in parentheses and separated by a "~" will appear on a device. If a line is indented then it is a continuation of the previous line and the two combined represent the entire Top-Side Marking for that device.

**Important Information and Disclaimer:** The information provided on this page represents TI's knowledge and belief as of the date that it is provided. TI bases its knowledge and belief on information provided by third parties, and makes no representation or warranty as to the accuracy of such information. Efforts are underway to better integrate information from third parties. TI has taken and continues to take reasonable steps to provide representative and accurate information but may not have conducted destructive testing or chemical analysis on incoming materials and chemicals. TI and TI suppliers consider certain information to be proprietary, and thus CAS numbers and other limited information may not be available for release.

In no event shall TI's liability arising out of such information exceed the total purchase price of the TI part(s) at issue in this document sold by TI to Customer on an annual basis.



**TAPE AND REEL INFORMATION**

**QUADRANT ASSIGNMENTS FOR PIN 1 ORIENTATION IN TAPE**

\*All dimensions are nominal

Device	Package Type	Package Drawing	Pins	SPQ	Reel Diameter (mm)	Reel Width W1 (mm)	A0 (mm)	B0 (mm)	K0 (mm)	P1 (mm)	W (mm)	Pin1 Quadrant
LM4880MX/NOPB	SOIC	D	8	2500	330.0	12.4	6.5	5.4	2.0	8.0	12.0	Q1

TAPE AND REEL BOX DIMENSIONS



\*All dimensions are nominal

Device	Package Type	Package Drawing	Pins	SPQ	Length (mm)	Width (mm)	Height (mm)
LM4880MX/NOPB	SOIC	D	8	2500	367.0	367.0	35.0

D (R-PDSO-G8)

PLASTIC SMALL OUTLINE



## IMPORTANT NOTICE

Texas Instruments Incorporated and its subsidiaries (TI) reserve the right to make corrections, enhancements, improvements and other changes to its semiconductor products and services per JESD46, latest issue, and to discontinue any product or service per JESD48, latest issue. Buyers should obtain the latest relevant information before placing orders and should verify that such information is current and complete. All semiconductor products (also referred to herein as "components") are sold subject to TI's terms and conditions of sale supplied at the time of order acknowledgment.

TI warrants performance of its components to the specifications applicable at the time of sale, in accordance with the warranty in TI's terms and conditions of sale of semiconductor products. Testing and other quality control techniques are used to the extent TI deems necessary to support this warranty. Except where mandated by applicable law, testing of all parameters of each component is not necessarily performed.

TI assumes no liability for applications assistance or the design of Buyers' products. Buyers are responsible for their products and applications using TI components. To minimize the risks associated with Buyers' products and applications, Buyers should provide adequate design and operating safeguards.

TI does not warrant or represent that any license, either express or implied, is granted under any patent right, copyright, mask work right, or other intellectual property right relating to any combination, machine, or process in which TI components or services are used. Information published by TI regarding third-party products or services does not constitute a license to use such products or services or a warranty or endorsement thereof. Use of such information may require a license from a third party under the patents or other intellectual property of the third party, or a license from TI under the patents or other intellectual property of TI.

Reproduction of significant portions of TI information in TI data books or data sheets is permissible only if reproduction is without alteration and is accompanied by all associated warranties, conditions, limitations, and notices. TI is not responsible or liable for such altered documentation. Information of third parties may be subject to additional restrictions.

Resale of TI components or services with statements different from or beyond the parameters stated by TI for that component or service voids all express and any implied warranties for the associated TI component or service and is an unfair and deceptive business practice. TI is not responsible or liable for any such statements.

Buyer acknowledges and agrees that it is solely responsible for compliance with all legal, regulatory and safety-related requirements concerning its products, and any use of TI components in its applications, notwithstanding any applications-related information or support that may be provided by TI. Buyer represents and agrees that it has all the necessary expertise to create and implement safeguards which anticipate dangerous consequences of failures, monitor failures and their consequences, lessen the likelihood of failures that might cause harm and take appropriate remedial actions. Buyer will fully indemnify TI and its representatives against any damages arising out of the use of any TI components in safety-critical applications.

In some cases, TI components may be promoted specifically to facilitate safety-related applications. With such components, TI's goal is to help enable customers to design and create their own end-product solutions that meet applicable functional safety standards and requirements. Nonetheless, such components are subject to these terms.

No TI components are authorized for use in FDA Class III (or similar life-critical medical equipment) unless authorized officers of the parties have executed a special agreement specifically governing such use.

Only those TI components which TI has specifically designated as military grade or "enhanced plastic" are designed and intended for use in military/aerospace applications or environments. Buyer acknowledges and agrees that any military or aerospace use of TI components which have **not** been so designated is solely at the Buyer's risk, and that Buyer is solely responsible for compliance with all legal and regulatory requirements in connection with such use.

TI has specifically designated certain components as meeting ISO/TS16949 requirements, mainly for automotive use. In any case of use of non-designated products, TI will not be responsible for any failure to meet ISO/TS16949.

### Products

Audio	<a href="http://www.ti.com/audio">www.ti.com/audio</a>
Amplifiers	<a href="http://amplifier.ti.com">amplifier.ti.com</a>
Data Converters	<a href="http://dataconverter.ti.com">dataconverter.ti.com</a>
DLP® Products	<a href="http://www.dlp.com">www.dlp.com</a>
DSP	<a href="http://dsp.ti.com">dsp.ti.com</a>
Clocks and Timers	<a href="http://www.ti.com/clocks">www.ti.com/clocks</a>
Interface	<a href="http://interface.ti.com">interface.ti.com</a>
Logic	<a href="http://logic.ti.com">logic.ti.com</a>
Power Mgmt	<a href="http://power.ti.com">power.ti.com</a>
Microcontrollers	<a href="http://microcontroller.ti.com">microcontroller.ti.com</a>
RFID	<a href="http://www.ti-rfid.com">www.ti-rfid.com</a>
OMAP Applications Processors	<a href="http://www.ti.com/omap">www.ti.com/omap</a>
Wireless Connectivity	<a href="http://www.ti.com/wirelessconnectivity">www.ti.com/wirelessconnectivity</a>

### Applications

Automotive and Transportation	<a href="http://www.ti.com/automotive">www.ti.com/automotive</a>
Communications and Telecom	<a href="http://www.ti.com/communications">www.ti.com/communications</a>
Computers and Peripherals	<a href="http://www.ti.com/computers">www.ti.com/computers</a>
Consumer Electronics	<a href="http://www.ti.com/consumer-apps">www.ti.com/consumer-apps</a>
Energy and Lighting	<a href="http://www.ti.com/energy">www.ti.com/energy</a>
Industrial	<a href="http://www.ti.com/industrial">www.ti.com/industrial</a>
Medical	<a href="http://www.ti.com/medical">www.ti.com/medical</a>
Security	<a href="http://www.ti.com/security">www.ti.com/security</a>
Space, Avionics and Defense	<a href="http://www.ti.com/space-avionics-defense">www.ti.com/space-avionics-defense</a>
Video and Imaging	<a href="http://www.ti.com/video">www.ti.com/video</a>

### TI E2E Community

[e2e.ti.com](http://e2e.ti.com)