

Using the UCC28180EVM-573

User's Guide



Literature Number: SLUUAT3B
October 2013–Revised December 2013

UCC28180EVM-573

360-W Power Factor Correction Module

1 Introduction

The UCC28180EVM-573 evaluation module (EVM) is a 360-W off-line power factor correction (PFC) boost converter providing a nominal output voltage of 390-V regulated output at 0.923 A of load current. The PFC converter accommodates an input voltage range of 85 V_{AC} to 265 V_{AC} and uses average current mode control at a fixed programmable switching frequency of 120 kHz. The UCC28180 incorporates a wide range of protection features to ensure safe system operation.

2 Description

The UCC28180EVM-573 highlights the many benefits of using the UCC28180 Continuous Current Mode Boost PFC Controller (TI Literature Number SLUSBQ5). The controller operates under average current mode control at a fixed programmable switching frequency of 120 kHz. Simple external current and voltage loop compensation, along with advanced protection features, make this controller ideal for server and desktop power supplies, industrial power supplies, and white goods.

This user's guide provides the schematic, component list, assembly drawing for a single-sided printed circuit board application, and test set up necessary to evaluate the UCC28180 in a typical PFC application.

2.1 Typical Applications

The UCC28180EVM-573 is suited for use in high-power off-line systems that require high-efficiency and advanced fault protection features, applications including, but not limited to:

- Server and Desktop Power Supplies
- Industrial Power Supplies (DIN Rail)
- White Goods
 - A/C Units
 - Refrigerators
 - etc.

2.2 Features

The UCC28180EVM-573 features include:

- AC Input Range 85 V_{AC} to 265 V_{AC}
- 360-W, 390-V Output
- Average Current Mode PWM Control
- No AC Line Sensing Needed
- Fixed 120-kHz Oscillator frequency, Programmable With a Single External Resistor
- Soft Over Current and Cycle-by-Cycle Peak Current Limiting
- VCC Under Voltage Lockout With Low Start-Up Current
- Voltage Regulation Open Loop Detection
- Output Over-Voltage Protection With Hysteresis Recovery
- Enhanced Dynamic Response
- Soft-Start

CAUTION

High voltage levels are present on the evaluation module whenever it is energized. Proper precautions must be taken when working with the EVM. The large bulk capacitor across the output terminals must be completely discharged before the EVM can be handled. Serious injury can occur if proper safety precautions are not followed.

3 Electrical Performance Specifications

Table 1. UCC28180EVM-573 Performance Summary

PARAMETER		TEST CONDITION	MIN	TYP	MAX	UNIT
Input Characteristics						
V_{IN}	Input voltage		85		265	V_{AC}
f_{LINE}	Input frequency		47		63	Hz
$I_{IN(no-load)}$	No load input current	$V_{IN} = V_{IN(max)}$, $f_{LINE} = 50$ Hz, $I_{OUT} = I_{OUT(min)}$		71		mA
$I_{IN(peak)}$	Peak input current	$V_{IN} = V_{IN(min)}$, $f_{LINE} = 60$ Hz, $I_{OUT} = I_{OUT(max)}$		6.8		A
Output Characteristics						
V_{OUT}	Output voltage	$V_{IN(min)} \leq V_{IN} \leq V_{IN(max)}$, $f_{LINE(min)} \leq f_{LINE} \leq f_{LINE(max)}$, $I_{OUT(min)} \leq I_{OUT} \leq I_{OUT(max)}$	379	390	402	VDC
	Line Regulation	$V_{IN(min)} \leq V_{IN} \leq V_{IN(max)}$, $I_{OUT} = I_{OUT(max)}$			5%	
	Load Regulation	$V_{IN} = 115$ VAC, $f_{LINE} = 60$ Hz, $I_{OUT(min)} \leq I_{OUT} \leq I_{OUT(max)}$			5%	
		$V_{IN} = 230$ VAC, $f_{LINE} = 60$ Hz, $I_{OUT(min)} \leq I_{OUT} \leq I_{OUT(max)}$			5%	
I_{OUT}	Output Load Current	$V_{IN(min)} \leq V_{IN} \leq V_{IN(max)}$, $f_{LINE(min)} \leq f_{LINE} \leq f_{LINE(max)}$	0		0.923	A
P_{OUT}	Output Power	$V_{IN(min)} \leq V_{IN} \leq V_{IN(max)}$, $f_{LINE(min)} \leq f_{LINE} \leq f_{LINE(max)}$	0		360	W
$V_{RIPPLE(SW)}$	High frequency Output voltage ripple	$V_{IN} = 115$ VAC, $f_{LINE} = 60$ Hz, $I_{OUT} = I_{OUT(max)}$			3.9	V_{P-P}
		$V_{IN} = 230$ VAC, $f_{LINE} = 50$ Hz, $I_{OUT} = I_{OUT(max)}$			3.9	
$V_{RIPPLE(LINE)}$	Line frequency Output voltage ripple	$V_{IN} = 115$ VAC, $f_{LINE} = 60$ Hz, $I_{OUT} = I_{OUT(max)}$			19.5	V_{P-P}
		$V_{IN} = 230$ VAC, $f_{LINE} = 50$ Hz, $I_{OUT} = I_{OUT(max)}$			19.5	
$V_{OUT(OVP)}$	Output over voltage protection			425		V
$V_{OUT(UVP)}$	Output under voltage protection			370		

Table 1. UCC28180EVM-573 Performance Summary (continued)

PARAMETER		TEST CONDITION	MIN	TYP	MAX	UNIT
Control Loop Characteristics						
f_{SW}	Switching frequency	$T_J = 25^\circ\text{C}$	114	120	126	kHz
$f_{(CO)}$	Voltage Loop Bandwidth	$V_{IN} = 162\text{ VDC},$ $I_{OUT} = 0.466\text{ A}$		8		Hz
	Voltage Loop Phase Margin	$V_{IN} = 162\text{ VDC},$ $I_{OUT} = 0.466\text{ A}$		68		°
PF	Power Factor	$V_{IN} = 115\text{ VAC},$ $I_{OUT} = I_{OUT(max)}$		0.99		
THD	Total harmonic distortion	$V_{IN} = 115\text{ VAC},$ $f_{LINE} = 60\text{ Hz},$ $I_{OUT} = I_{OUT(max)}$		4.1%	10%	
		$V_{IN} = 230\text{ VAC},$ $f_{LINE} = 50\text{ Hz},$ $I_{OUT} = I_{OUT(max)}$		4%	10%	
η	Full load efficiency	$V_{IN} = 115\text{ VAC},$ $f_{LINE} = 60\text{ Hz},$ $I_{OUT} = I_{OUT(max)}$		94.5%		
	Ambient temperature			25		°C

4 Schematic

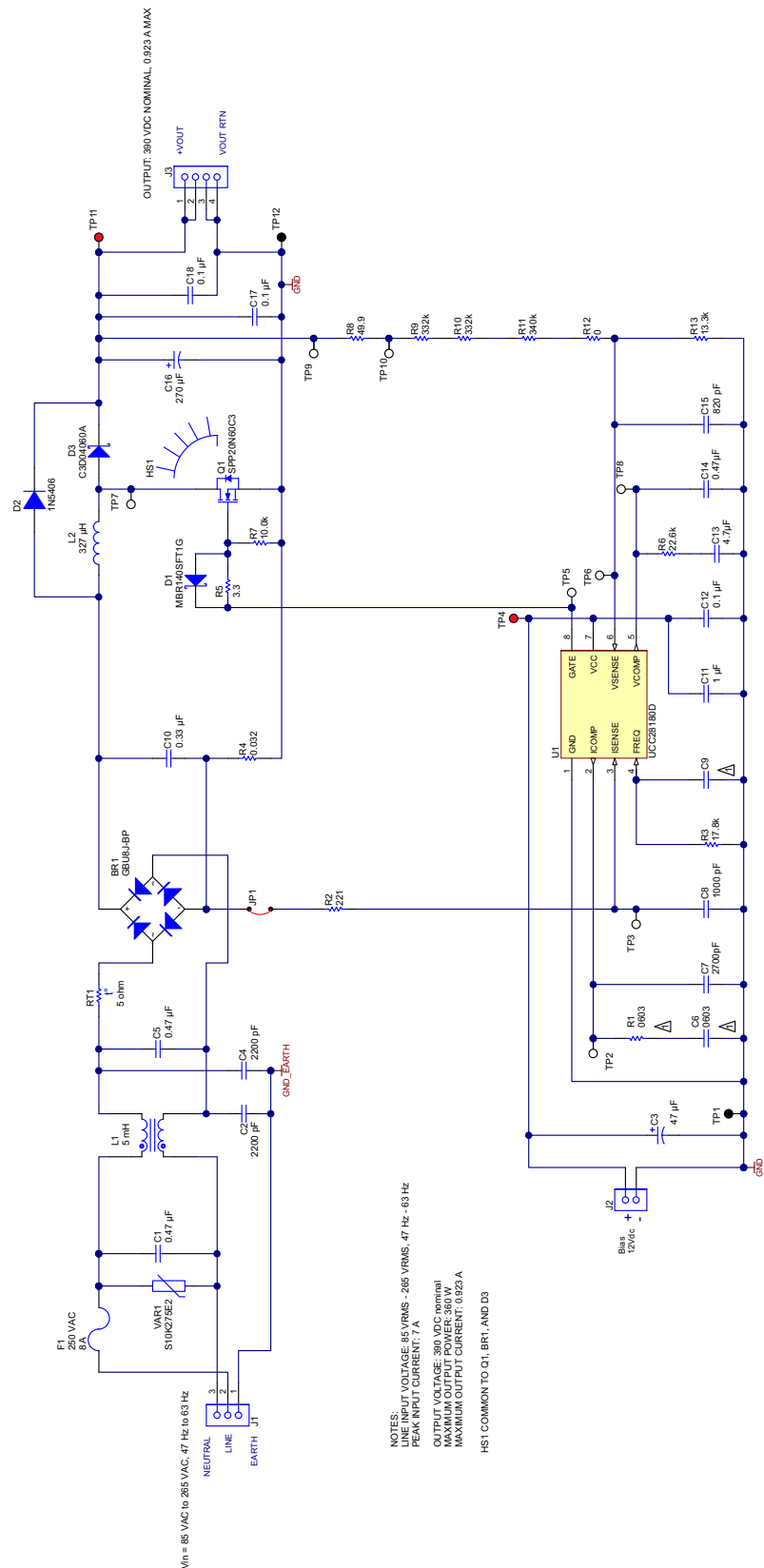

Figure 1. UCC28180EVM-573 Schematic

5 Test Setup

Figure 2 shows the basic test set up recommended in order to evaluate the UCC28180EVM-573

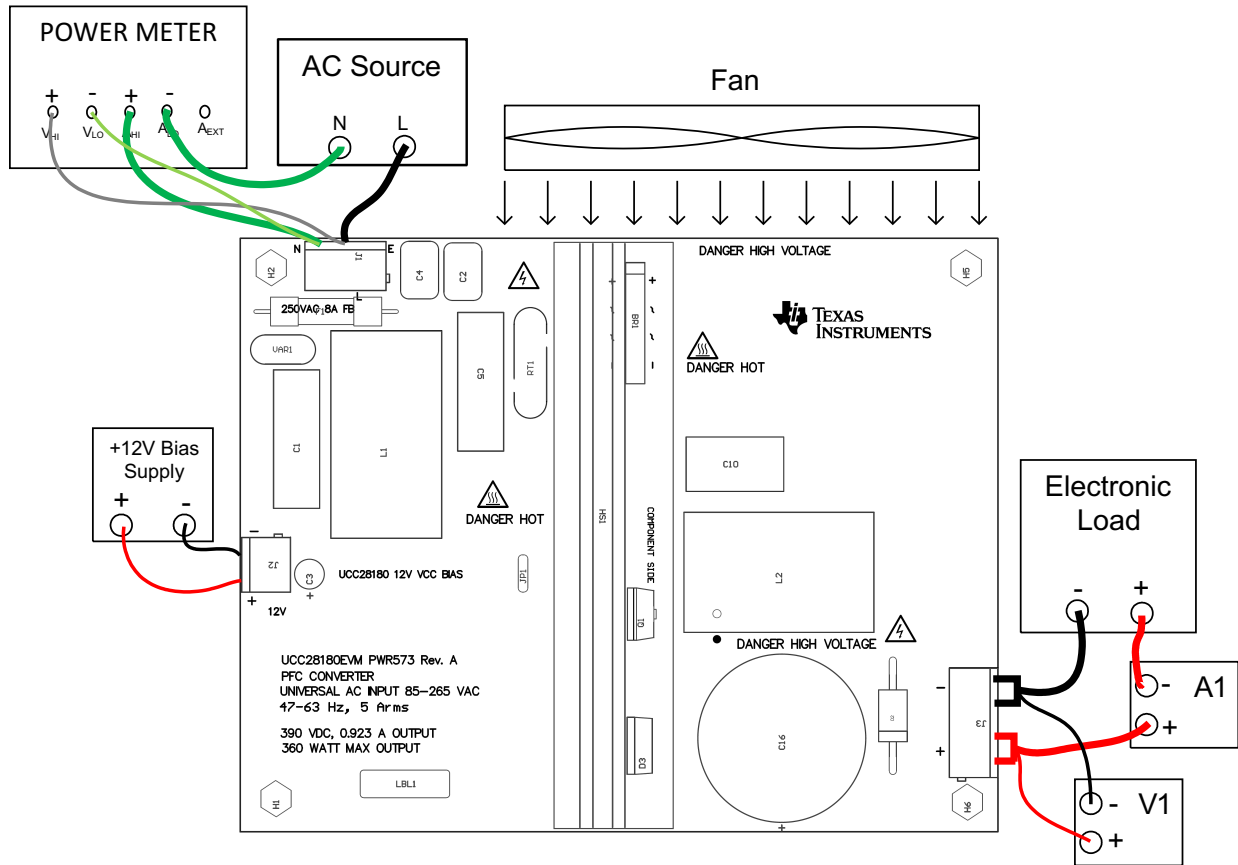

Figure 2. UCC28180EVM-573 Recommended Test Set Up

WARNING

High voltages that may cause injury exist on this evaluation module (EVM). Please ensure all safety procedures are followed when working on this EVM. Never leave a powered EVM unattended.

5.1 Test Equipment

AC Voltage Source: The AC input source shall be capable of supplying between 85 V_{AC} and 265 V_{AC} at no less than 8 A peak. Connect the AC source to the L and N terminals of J1 on the EVM as shown in [Figure 2](#). For accurate efficiency calculations, a power meter should be inserted between the neutral line of the AC source and the neutral terminal of the EVM. For highest accuracy, connect the voltage terminals of the power meter directly across the line and neutral terminals of the EVM.

12-V Bias Supply: The bias supply to the device shall be capable of supplying up to 12 V_{DC} at no less than 10 mA. Connect the bias supply to the – and + terminals of J2, UCC28180 12-V VCC bias, as shown in [Figure 2](#).

Output Load: A programmable electronic load set to constant current mode and capable of sinking 0 to 1 A at 390 V_{DC} shall be used. Connect the load to J3, as shown in [Figure 2](#).

Power Meter: For highest accuracy, power analyzer shall be used to measure the input power, THD, and power factor. An example of such an analyzer is the Voltech PM100 Single Phase Power Analyzer.

Multimeters: For highest accuracy, the output voltage of the UCC28180EVM-573 shall be monitored by connecting a digital voltmeter, V1, directly across TP11 and TP12 with the positive terminal at TP11 and the negative terminal at TP12. A DC current meter, A1, should be placed in series with the electronic load for accurate output current measurements.

Oscilloscope: A digital or analog oscilloscope with 500-MHz scope probes is recommended.

Fan: A fan, capable of 200 LFM to 400 LFM, should be used to maintain component temperatures within safe operating ranges at all times during operation of the UCC28180EVM-573. Position the fan so as to blow along the length of the heatsink as shown in [Figure 2](#).

Recommended Wire Gauge: The recommended wire size is AWG #16 with the total length of wire less than 8 feet (4 feet input, 4 feet return). The connection between the EVM output terminals (J3) and the electronic load can carry as much as 1 A. The minimum recommended wire size is AWG #20, with the total length of wire less than 8 feet (4 feet output, 4 feet return).

5.2 List of Test Points

Table 2. Test Point Functional Description

TEST POINT	NAME	DESCRIPTION
TP1	PGND	Power ground
TP2	ICOMP	UCC28180 pin 2
TP3	ISENSE	UCC28180 pin 3
TP4	VCC	UCC28180 pin 7
TP5	GATE	UCC28180 pin 8
TP6	VSENSE	UCC28180 pin 6
TP7	SW	Switch node, MOSFET drain
TP8	VCOMP	UCC28180 pin 5
TP9	+ LOOP	Loop injection point, EVM output
TP10	- LOOP	Loop injection point
TP11	+VOUT	Positive output terminal of the EVM to the load
TP12	-VOUT	Return connection of the EVM output to the load

5.3 Power-Up/Power-Down Procedure

The following test procedure is recommended primarily for power up and shutting down the evaluation module. Never leave a powered EVM unattended for any length of time. Also, the unit should never be handled while power is applied to it or the output voltage is greater than 50 V_{DC}.

WARNING

There are very high voltages present on the EVM. Some components reach temperatures above 50°C. Precautions must be taken when handling the board. Never operate the UCC28180EVM-573 without the fan running. Always make certain the bulk capacitors have completely discharged prior to handling the EVM.

1. Working at an ESD workstation, make sure that the ionizer is on before the EVM is removed from the protective packaging and power is applied. Electrostatic smock and safety glasses should also be worn. Because voltages in excess of 400 V may be present on the EVM, do not connect the ground strap from the smock to the bench. If testing with a load, set the electronic load to constant resistance mode.
2. Power-Up
 - (a) Connect the equipment as shown in [Figure 2](#).
 - (b) Turn on the fan.
 - (c) Set the AC source voltage between 85 V_{AC} and 265 V_{AC}.
 - (d) Turn on the 12-V bias supply and verify that the output of the module is within regulation.
 - (e) Increase the load from 0 A up to 0.923 A.

5.4 Line/Load Regulation and Efficiency Measurement Procedure

1. For load regulation, use the test set up shown in [Figure 2](#).
 - (a) Set the AC source to a constant voltage between 85 V_{AC} and 265 V_{AC}.
 - (b) Vary the load so that the output current varies from 0 A up to 0.923 A, as measured on DMM A1.
 - (c) Observe that the output voltage on DMM V1 remains within 5% of the full load regulation value.
2. For line regulation, use the test set up shown in [Figure 2](#).
 - (a) Set the load to sink the full-load current, 0.923 A.
 - (b) Vary the AC source from 85 V_{AC} to 265 V_{AC}
 - (c) Observe that the output voltage on DMM V1 stays within 5% of the output voltage regulation value.

5.5 Output Voltage Ripple

1. Expose the ground barrel of the scope probe and place the tip of the probe on TP11, +VOUT, and rest the exposed ground barrel of the probe on TP12, -VOUT, for output voltage ripple measurements.

5.6 Equipment Shutdown

1. To quickly discharge the output capacitors, make sure there is a load greater than 0 A on the EVM.
2. Turn off the AC source.
3. Turn off the Bias source.

6 Performance Data and Typical Characteristic Curves

Figure 3 through Figure 21 present typical performance curves for UCC28180EVM-573.

6.1 Efficiency

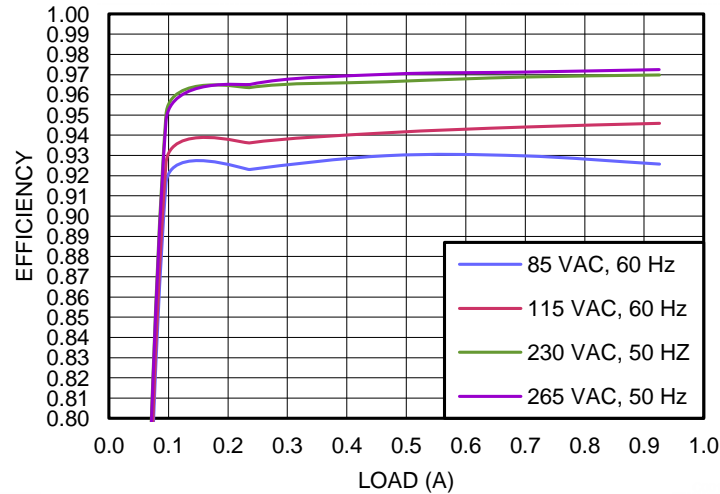

**Figure 3. UCC28180EVM-573 Efficiency
(as a function of line voltage and load current)**

6.2 Power Factor

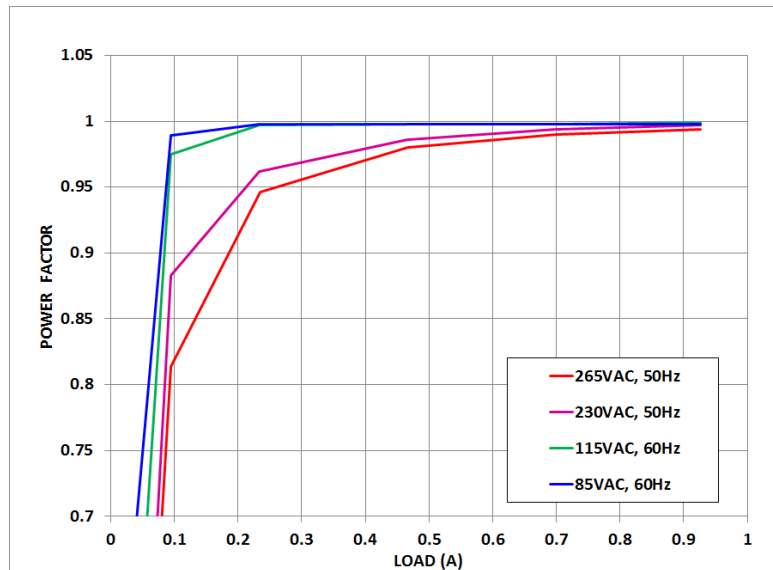

**Figure 4. UCC28180EVM-573 Power Factor
(as a function of line voltage and load current)**

6.3 Total Harmonic Distortion

Figure 5 shows the measured total harmonic distortion (THD). This design allows the converter to enter into discontinuous current mode (DCM) at the higher line voltages which impacts THD. The converter still meets the design goal of less than 10% THD at full load over the entire input line range despite using a relatively small inductor that allows 40% inductor ripple current.

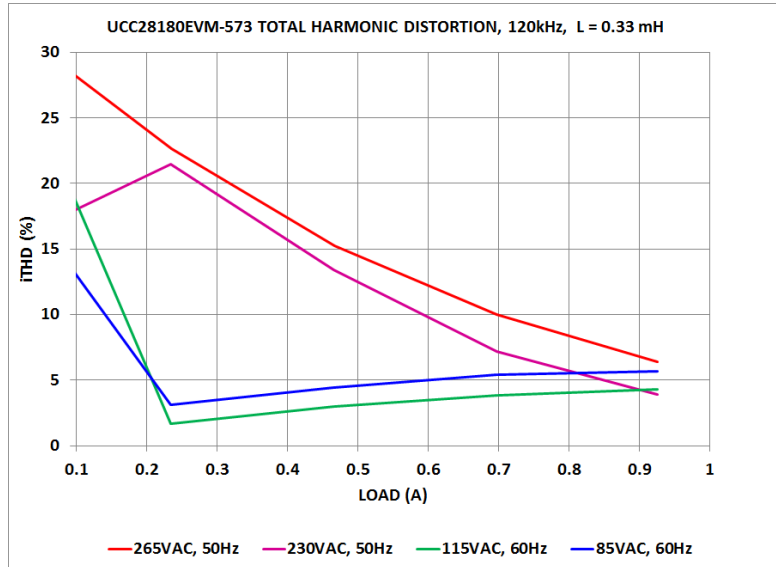

Figure 5. UCC28180EVM-573 Total harmonic Distortion (as a function of line voltage and load current)

Figure 6 demonstrates improved THD by doubling inductance (20% ripple).

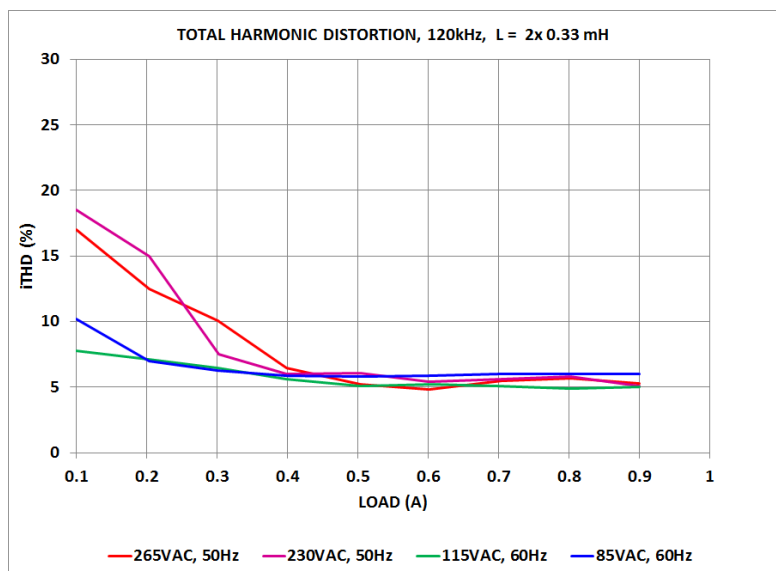

Figure 6. Total Harmonic Distortion with 2x Inductance

Using swinging inductors which exhibit higher inductance value at lower magnetization (lowest current) can also help to achieve low THD. Figure 7 shows the total harmonic distortion resulting from using a current of 6.4 A (switching frequency = 18 kHz). The total harmonic distortion measures less than 5% from 50% load to full load under these conditions.

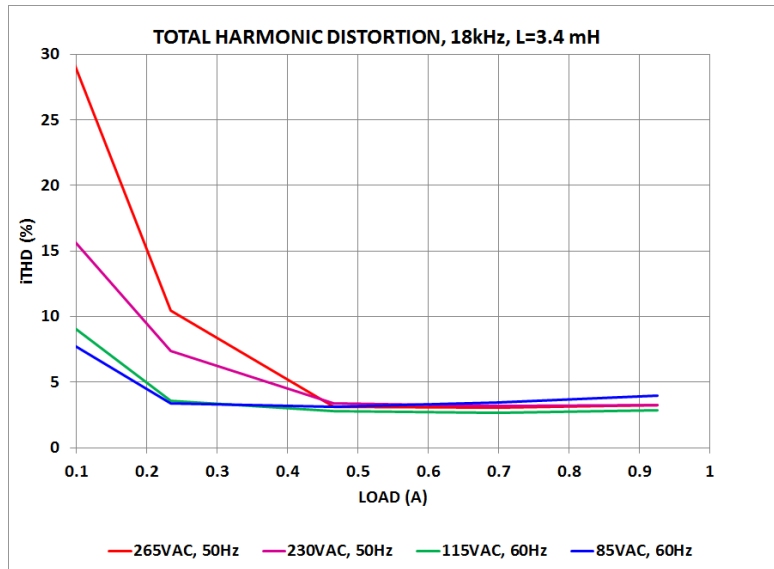

Figure 7. Total harmonic distortion (as a function of line voltage and load current) with L = 3.4 mH and f_{SW} = 18 kHz

Figure 8 shows the total harmonic distortion resulting from a swinging choke that measured 530 μH at a current of 6.4 A (switching frequency = 66 kHz). The total harmonic distortion measures less than 5% from 50% load to full load under these conditions.

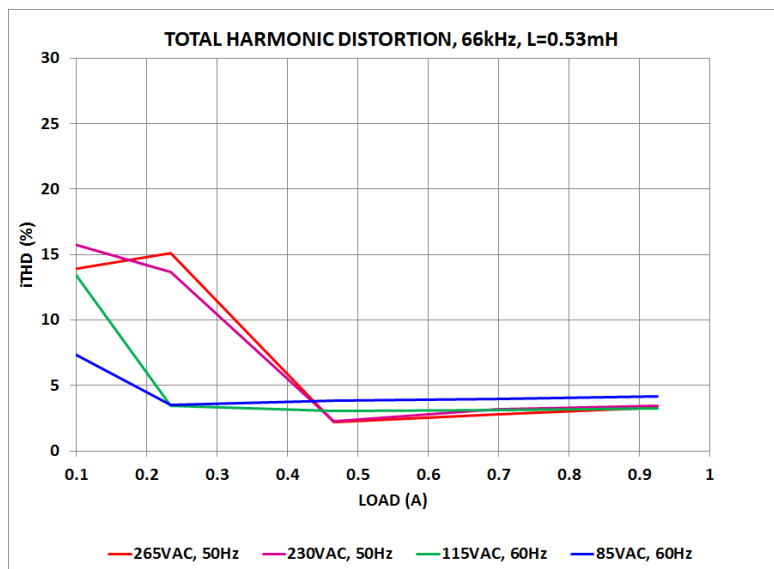

Figure 8. Total harmonic distortion (as a function of line voltage and load current) with L = 0.4 mH and f_{SW} = 66 kHz

6.4 Current Harmonics

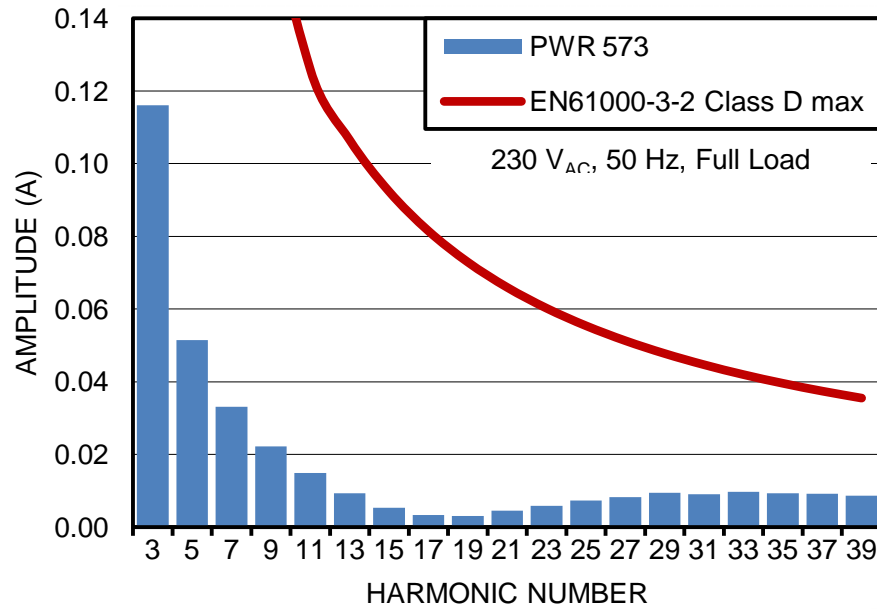

Figure 9. UCC28180EVM-573 Current Harmonics, (230-V_{AC}, 50-Hz input, full load, without the fundamental)

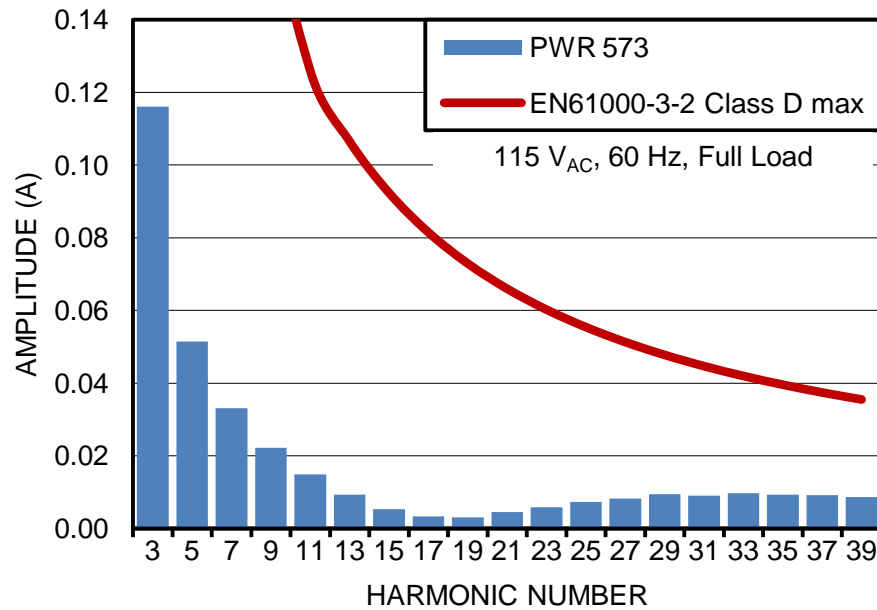

Figure 10. UCC28180EVM-573 Current Harmonics, (115-V_{AC}, 60-Hz input, full load, without the fundamental)

6.5 Input Current

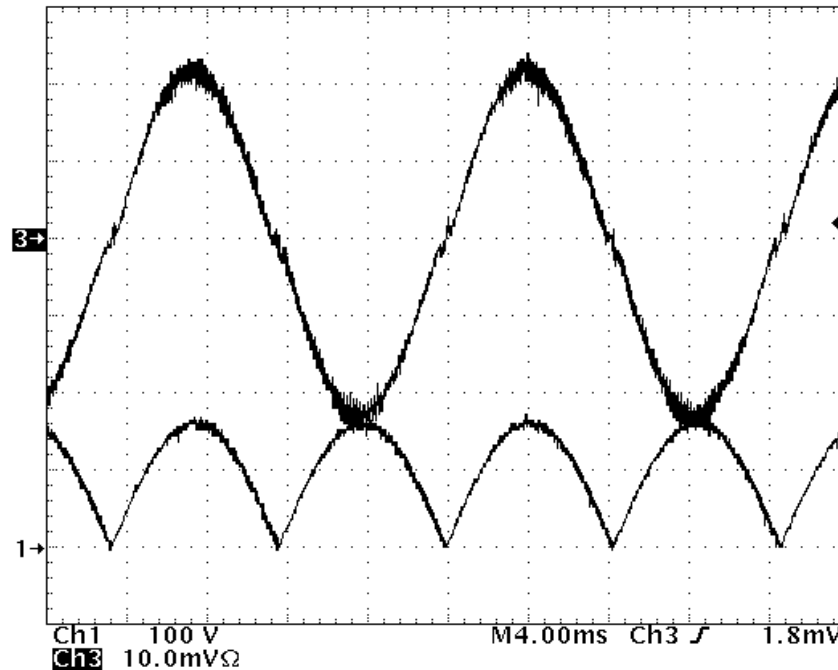

Figure 11. UCC28180EVM-573 Input Current and Input Voltage at the Output of the Bridge Rectifier, (115- V_{AC} , 60 Hz, full load. (CH 1 = rectified input voltage on BR1, 100 V/div., CH 3 = I_{IN} 2 A/div.))

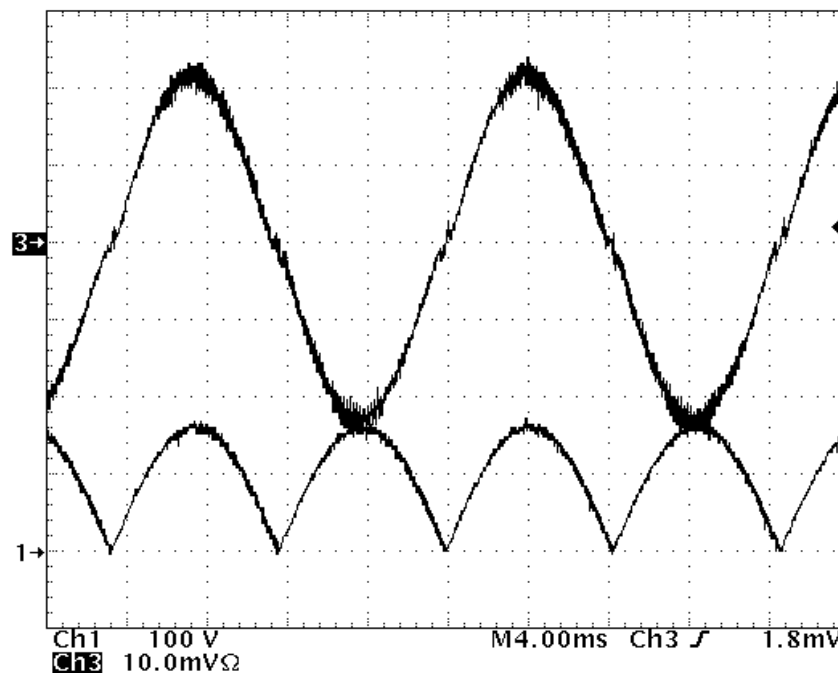

Figure 12. UCC28180EVM-573 Input Current and Input Voltage at the Output of the Bridge Rectifier, (230 V_{AC} , 50 Hz, full load. (CH 1 = rectified input voltage on BR1, 100 V/div., CH 3 = I_{IN} 1 A/div.))

6.6 Output Voltage Ripple

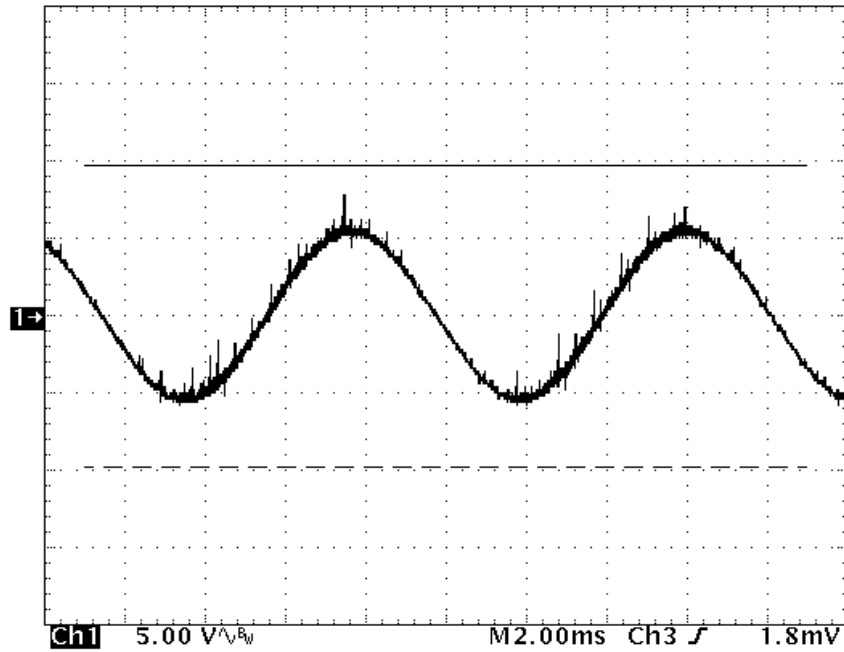

Figure 13. UCC28180EVM-573 Line Frequency Output Voltage Ripple (115 V_{AC}, 60 Hz input, full load)

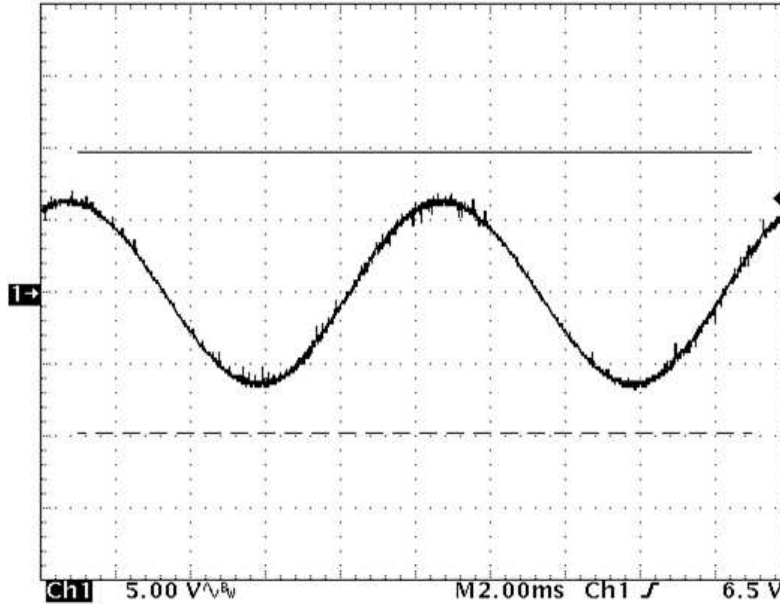

Figure 14. UCC28180EVM-573 Line Frequency Output Voltage Ripple (230 V_{AC}, 50 Hz input, full load)

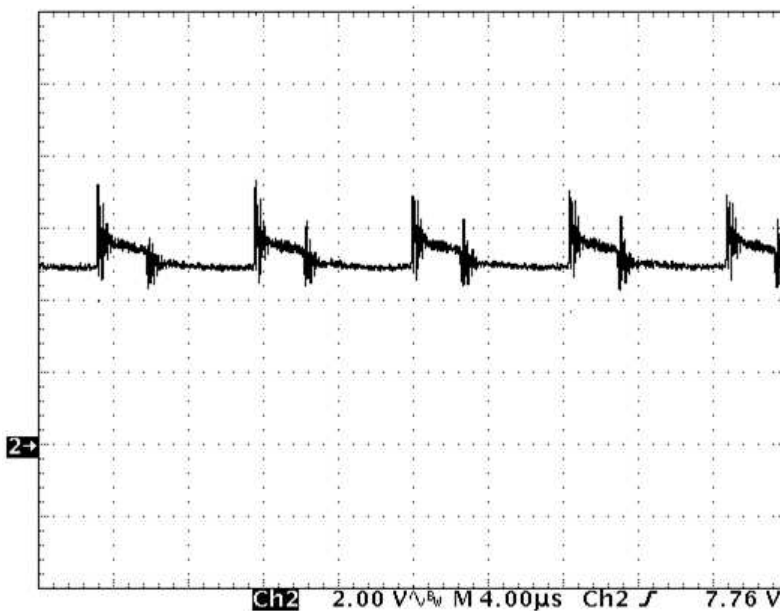

Figure 15. UCC28180EVM-573 Switching Frequency Output Voltage Ripple (115 V_{AC}, 60 Hz input, full load)

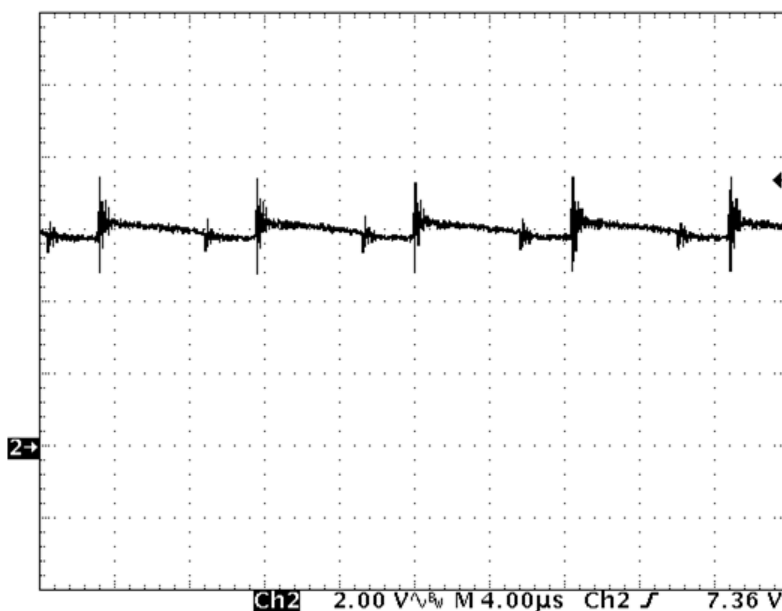

Figure 16. UCC28180EVM-573 Switching Frequency Output Voltage Ripple (230 V_{AC}, 50 Hz input, full load)

6.7 Start Up

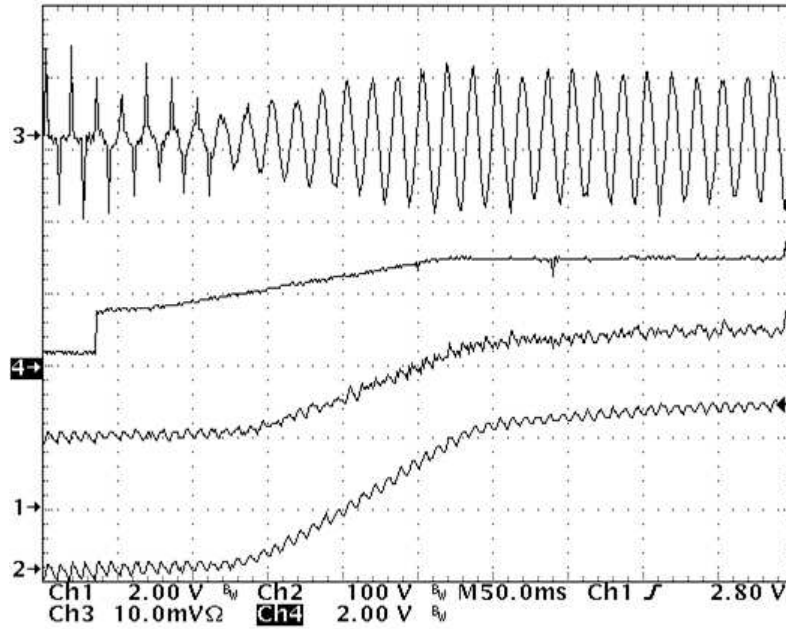

Figure 17. UCC28180EVM-573 Start-Up Waveform (115-V_{AC}, 60-Hz input, full load, CH 1 = V_{SENSE} at 2 V/div, CH 2 = V_{OUT} at 100 V/div., offset by 150 V, CH 3 = I_{IN} at 5 A/div., CH 4 = V_{COMP} at 2 V/div.)

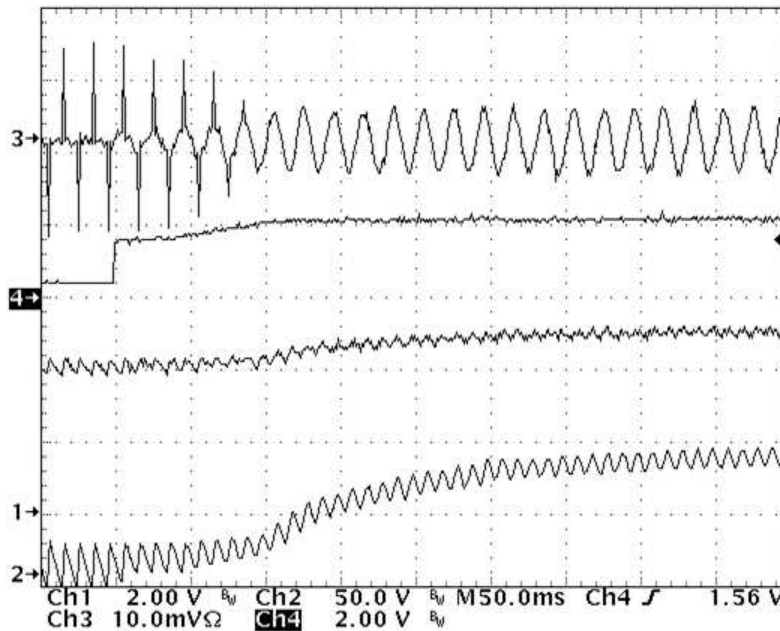

Figure 18. UCC28180EVM-573 Start-Up Waveform (230-V_{AC}, 50-Hz input, full load, CH 1 = V_{SENSE} at 2 V/div, CH 2 = V_{OUT} at 50 V/div., offset by 300 V, CH 3 = I_{IN} at 5 A/div., CH 4 = V_{COMP} at 2 V/div.)

6.8 Load Transient

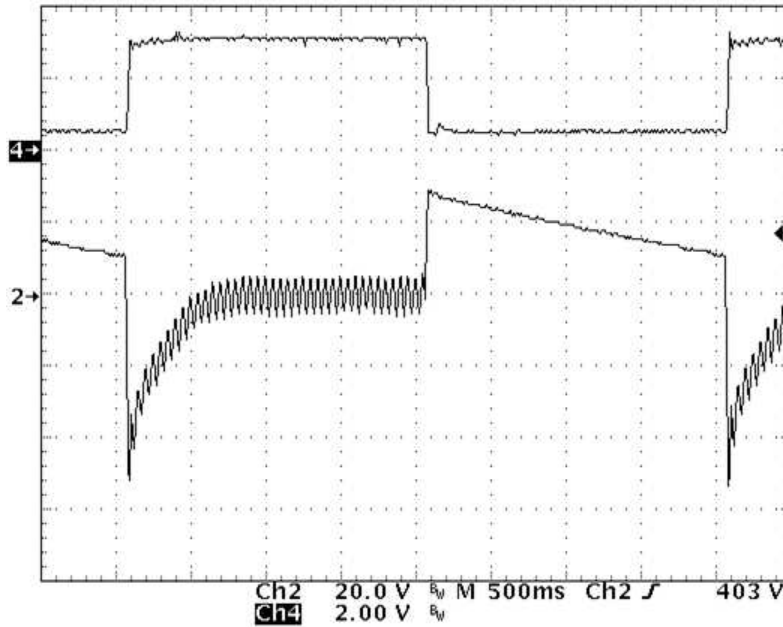

Figure 19. Load Transient

(115 -V_{AC}, 60-Hz, load step: 0% to 100%. Ch 2 = V_{OUT} at 20 V/div., offset by 386 V, Ch.4 = V_{COMP} at 2 V/div)

6.9 Bode Plot

The gain, phase bode plots were measured with an AP Instruments Inc. Model 200 analog network analyzer. The loop result was obtained by inserting a 1.77-V AC signal across TP9 and TP10. A DC input equal to the peak of the RMS input was used.

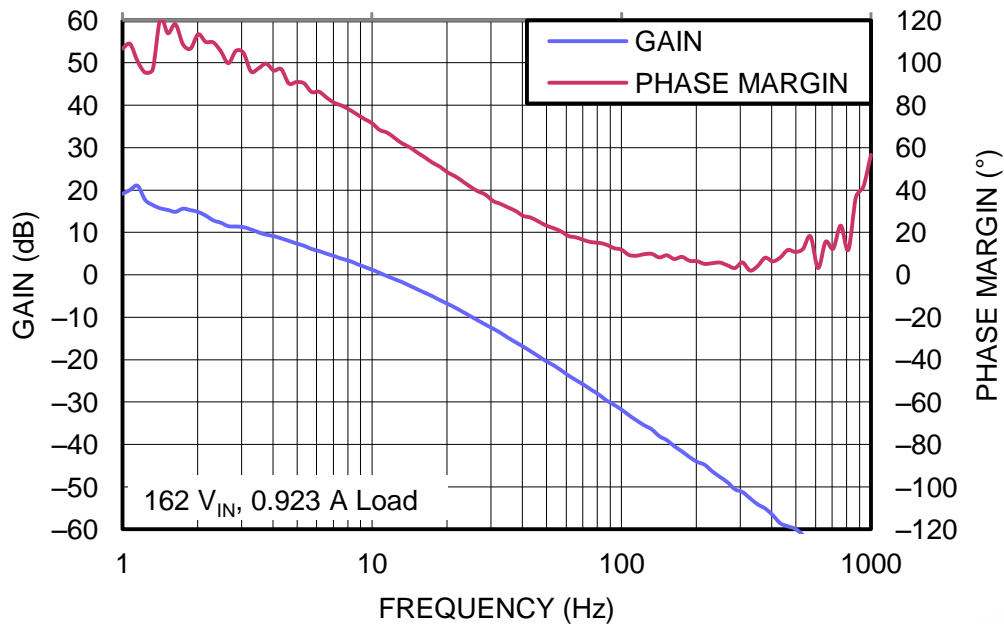

Figure 20. UCC28180EVM-573 Voltage Loop Response Gain and Phase, (311-V_{DC}, full load, f_{CO} = 10.7-Hz, phase margin = 68 degrees)

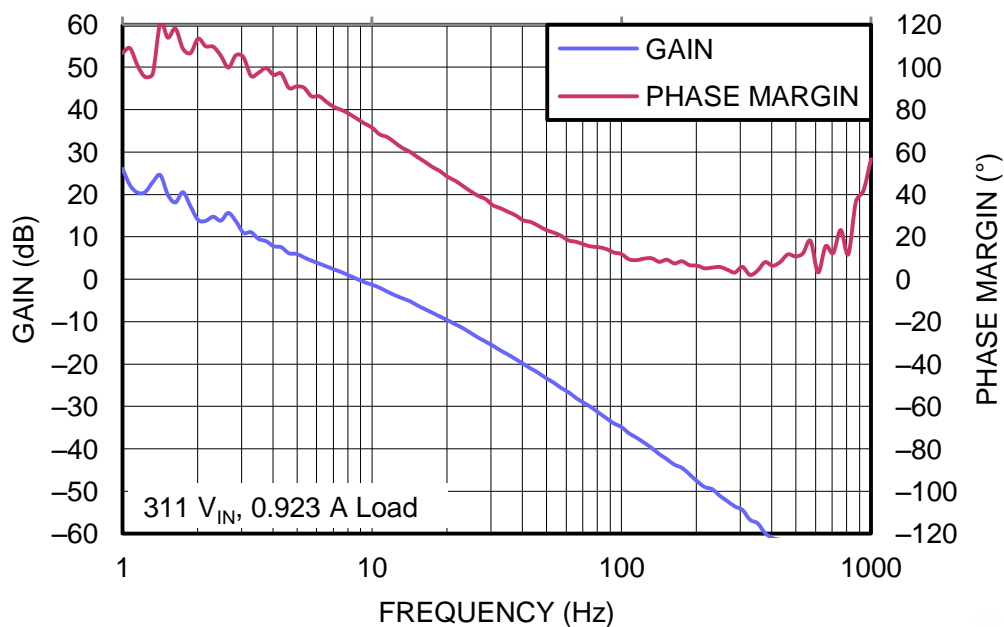

Figure 21. UCC28180EVM-573 Voltage Loop Response Gain and Phase, (162-V_{DC}, full load, f_{CO} = 8.6-Hz, phase margin = 63 degrees)

7 EVM Assembly Drawing and PCB Layout

The following figures (Figure 22 through Figure 25) show the design of the UCC28180EVM-573 printed circuit board.

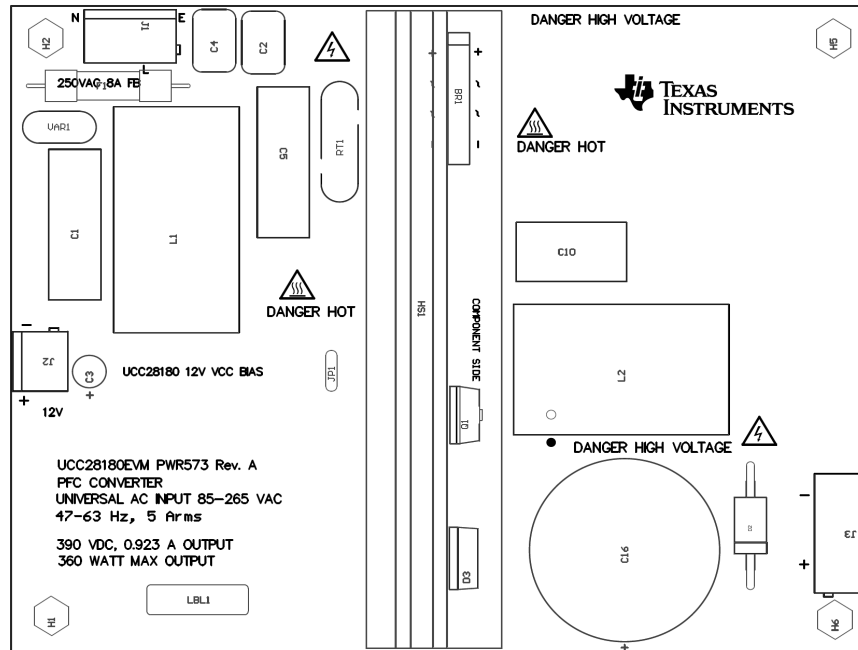

Figure 22. UCC28180EVM-573 Top Layer Assembly Drawing (top view)

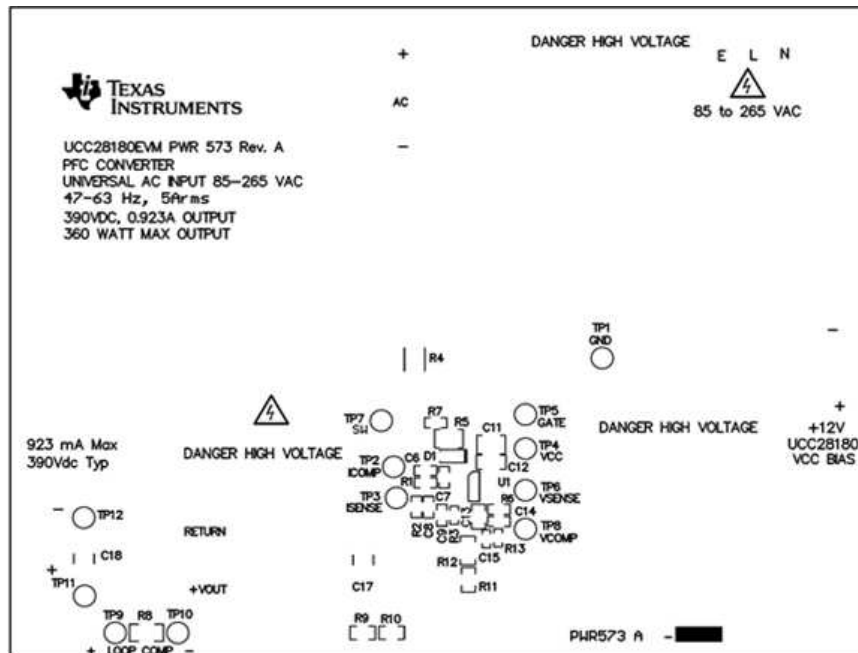

Figure 23. UCC28180EVM-573 Bottom Layer Assembly Drawing (bottom view)

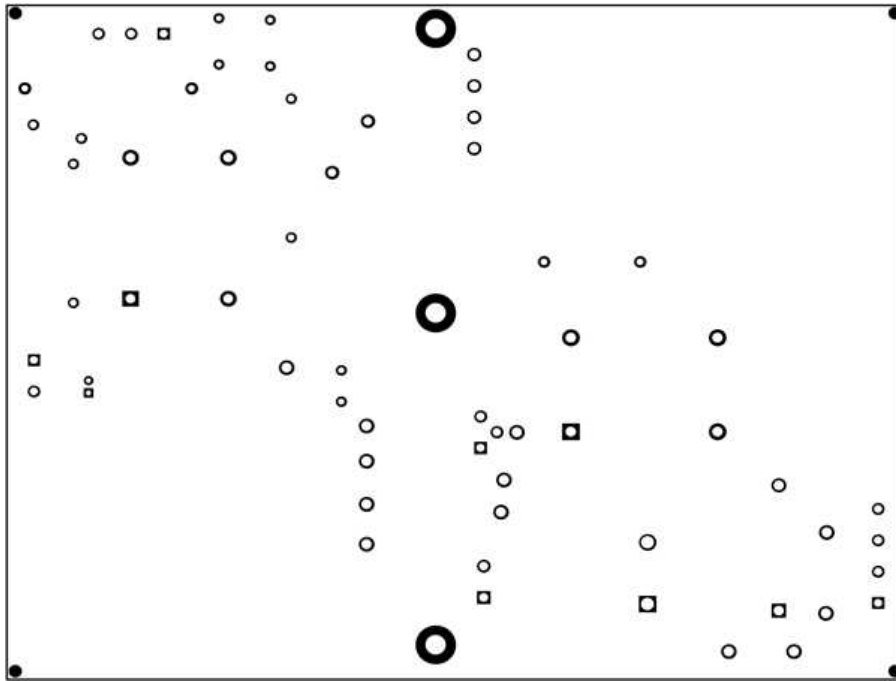

Figure 24. UCC28180EVM-573 Top Copper (top view)

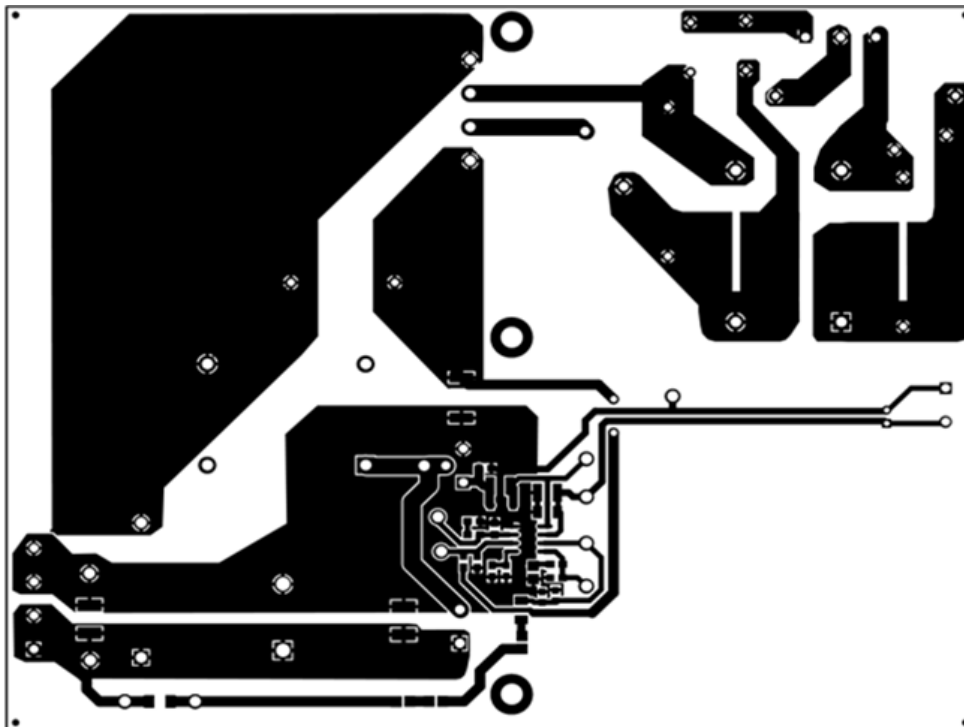

Figure 25. UCC28180EVM-573 Bottom Copper (bottom view)

8 List of Materials

The EVM components list according to the schematic shown in [Figure 1](#).

Table 3. UCC28180EVM-573 List of Materials

QTY	REFDES	DESCRIPTION	MFR	PART NUMBER
1	BR1	Diode, Switching-Bridge, 420 V, 8 A, TH	Micro Commercial Components	GBU8J-BP
2	C1, C5	Capacitor, film, 0.47 μ F, 275 V, \pm 20%, radial, 25 x 8.5 x 18.5 mm	Panasonic	ECQ-U2A474ML
2	C2, C4	Capacitor, ceramic, 2200 pF, 250 V, \pm 20%, E, radial disc D10.5 x 7 mm	TDK	CS11-E2GA222MYNS
1	C3	Capacitor, aluminum, 47 μ F, 35 V, \pm 20%, radial, 5 x 1mm	Panasonic	ECA-1VM470
0	C6	Capacitor, ceramic, 0.1 μ F, 50 V, \pm 10%, X7R, 0603	AVX	06035C104KAT2A
1	C7	Capacitor, ceramic, 2700 pF, 50 V, \pm 10%, X7R, 0603	MuRata	GRM188R71H272KA01D
1	C8	Capacitor, ceramic, 1000 pF, 100 V, \pm 10%, X7R, 0603	AVX	06031C102KAT2A
0	C9	Capacitor, ceramic, 0.68 μ F, 10 V, \pm 10%, X5R, 0603	Kemet	C0603C684K8PAC
1	C10	Capacitor, FILM, 0.33 μ F, 275 V, \pm 20%, radial, 17.5 x 17.5 x 9.5 mm	Panasonic	ECQ-U2A334ML
1	C11	Capacitor, ceramic, 1 μ F, 50 V, \pm 10%, X7R, 1210	MuRata	GRM32RR71H105KA01L
1	C12	Capacitor, ceramic, 0.1 μ F, 50 V, \pm 10%, X7R, 1206	AVX	12065C104KAT2A
1	C13	Capacitor, ceramic, 4.7 μ F, 10 V, \pm 10%, X7R, 0805	MuRata	GRM21BR71A475KA73L
1	C14	Capacitor, ceramic, 0.47 μ F, 16 V, \pm 10%, X7R, 0603	Kemet	C0603C474K4RACTU
1	C15	Capacitor, ceramic, 820 pF, 50 V, \pm 10%, X7R, 0603	Kemet	C0603C821K5RACTU
1	C16	Capacitor, aluminum, 270 μ F, 450 V, \pm 20%, 0.737 Ω , radial, 30 x 30 mm	Panasonic	EETUQ2W271DA
2	C17, C18	Capacitor, ceramic, 0.1 μ F, 630 V, \pm 10%, X7R, 1812	MuRata	GRM43DR72J104KW01L
1	D1	Diode, Schottky, 40 V, 1 A, SOD-123FL	ON Semiconductor	MBR140SFT1G
1	D2	Diode, Switching, 600 V, 3 A, DO-201AD	Vishay-Semiconductor	1N5406
1	D3	Diode, Schottky, 600 V, 4 A, TO-220-F2	Cree	C3D04060A
1	F1	Fuse, 8 A, 250 V, 20 x 5.2 mm	Littelfuse	0216008.MXESPP
3	H9, H10, H11	Max clip	Aavid Thermalloy	MAX01NG
1	HS1	Heatsink vertical max clip, black, 4.25 inches	Aavid	782653B04250G
1	J1	Terminal block, 5.08 mm, vertical 3 pos	On-Shore Technology	ED120/3DS
1	J2	Terminal block, 5.08 mm, vertical, 2 pos	On-Shore Technology	ED120/2DS
1	J3	Terminal block, 5.08 mm, vertical, 4 pos, TH	On-Shore Technology	ED120/4DS
1	JP1	Jumper wire, 200 mil spacing, red	3M	923345-02-C
1	L1	Coupled inductor, 5 mH, 0.022 A, 0.022 Ω , 1450 x 1500 x 800 mil	Bourns	8113-RC
1	L2	Inductor, toroid, ferrite, 327 μ H, 0.065 Ω , 1380 x 1310 x 880 mil	Nova Magnetics	7840-09-0014
1	Q1	MOSFET, N-channel, 650 V, 20.7 A, TO-220AB	Infineon Technologies	SPP20N60C3

Table 3. UCC28180EVM-573 List of Materials (continued)

QTY	REFDES	DESCRIPTION	MFR	PART NUMBER
0	R1	Resistor, 100 Ω , $\pm 1\%$, 0.1 W, 0603	Vishay-Dale	CRCW0603100RFKEA
1	R2	Resistor, 221 Ω , 1%, 0.1 W, 0603	Vishay-Dale	CRCW0603221RFKEA
1	R3	Resistor, 17.8 k Ω , $\pm 1\%$, 0.1 W, 0603	Vishay-Dale	CRCW060317K8FKEA
1	R4	Resistor, 0.032 Ω , $\pm 1\%$, 2 W, 2512	Vishay-Dale	WSL2512R0320FEA18
1	R5	Resistor, 3.3 Ω , 5%, 0.5 W, 1210	Panasonic	ERJ-P14J3R3U
1	R6	Resistor, 22.6 k Ω , $\pm 1\%$, 0.1 W, 0603	Vishay-Dale	CRCW060322K6FKEA
1	R7	Resistor, 10.0 k Ω , $\pm 1\%$, 0.1 W, 0603	Vishay-Dale	CRCW060310K0FKEA
1	R8	Resistor, 49.9 Ω , $\pm 1\%$, 0.25 W, 1206	Vishay-Dale	CRCW120649R9FKEA
2	R9, R10	Resistor, 332 k Ω , $\pm 1\%$, 0.125 W, 0805	Vishay-Dale	CRCW0805332KFKEA
1	R11	Resistor, 340 k Ω , $\pm 1\%$, 0.125 W, 0805	Vishay-Dale	CRCW0805340KFKEA
1	R12	Resistor, 0 Ω , $\pm 5\%$, 0.25 W, 1206	Vishay-Dale	CRCW1206000Z0EA
1	R13	Resistor, 13.0 k Ω , $\pm 1\%$, 0.1 W, 0603	Vishay-Dale	CRCW060313K3FKEA
1	RT1	Thermistor NTC, 5 Ω , $\pm 25\%$, Disc, 220 x 770 mil	GE Sensing	CL-40
2	SIL1, SIL2	Silicon thermal pad	Bergquist Company	Q3-0.005-00-58
1	SIL3	Silicon thermal pad	Bergquist Company	SP900S-0.009-00-114
2	TP1, TP12	Test point, multipurpose, black, TH	Keystone	5011
8	TP2, TP3, TP5, TP6, TP7, TP8, TP9, TP10	Test point, multipurpose, white, TH	Keystone	5012
2	TP4, TP11	Test point, multipurpose, red, TH	Keystone	5010
1	U1	8-Pin Continuous Conduction Mode (CCM) PFC Controller, SOIC-8	Texas Instruments	UCC28180D
1	VAR1	Varistor, 275 V_{RMS} , 10 mm, radial, 10 mm	EPCOS Inc	S10K275E2

Revision History

Changes from Original (October 2013) to A Revision	Page
• Changed 39-V regulated output to 390-V regulated output.	2
• Added Figure 7	12
• Added Figure 8	12
• Changed CH2 to Ch3.	14
• Changed Ch2 to CH3.	14
• Changed R13 resistor value from 13.3 k Ω to 13.0 k Ω	23

NOTE: Page numbers for previous revisions may differ from page numbers in the current version.

Changes from A Revision (November 2013) to B Revision	Page
• Changed Performance data and typical characteristic curve images.	10

NOTE: Page numbers for previous revisions may differ from page numbers in the current version.

EVALUATION BOARD/KIT/MODULE (EVM) ADDITIONAL TERMS

Texas Instruments (TI) provides the enclosed Evaluation Board/Kit/Module (EVM) under the following conditions:

The user assumes all responsibility and liability for proper and safe handling of the goods. Further, the user indemnifies TI from all claims arising from the handling or use of the goods.

Should this evaluation board/kit not meet the specifications indicated in the User's Guide, the board/kit may be returned within 30 days from the date of delivery for a full refund. THE FOREGOING LIMITED WARRANTY IS THE EXCLUSIVE WARRANTY MADE BY SELLER TO BUYER AND IS IN LIEU OF ALL OTHER WARRANTIES, EXPRESSED, IMPLIED, OR STATUTORY, INCLUDING ANY WARRANTY OF MERCHANTABILITY OR FITNESS FOR ANY PARTICULAR PURPOSE. EXCEPT TO THE EXTENT OF THE INDEMNITY SET FORTH ABOVE, NEITHER PARTY SHALL BE LIABLE TO THE OTHER FOR ANY INDIRECT, SPECIAL, INCIDENTAL, OR CONSEQUENTIAL DAMAGES.

Please read the User's Guide and, specifically, the Warnings and Restrictions notice in the User's Guide prior to handling the product. This notice contains important safety information about temperatures and voltages. For additional information on TI's environmental and/or safety programs, please visit www.ti.com/esh or contact TI.

No license is granted under any patent right or other intellectual property right of TI covering or relating to any machine, process, or combination in which such TI products or services might be or are used. TI currently deals with a variety of customers for products, and therefore our arrangement with the user is not exclusive. TI assumes no liability for applications assistance, customer product design, software performance, or infringement of patents or services described herein.

REGULATORY COMPLIANCE INFORMATION

As noted in the EVM User's Guide and/or EVM itself, this EVM and/or accompanying hardware may or may not be subject to the Federal Communications Commission (FCC) and Industry Canada (IC) rules.

For EVMs **not** subject to the above rules, this evaluation board/kit/module is intended for use for ENGINEERING DEVELOPMENT, DEMONSTRATION OR EVALUATION PURPOSES ONLY and is not considered by TI to be a finished end product fit for general consumer use. It generates, uses, and can radiate radio frequency energy and has not been tested for compliance with the limits of computing devices pursuant to part 15 of FCC or ICES-003 rules, which are designed to provide reasonable protection against radio frequency interference. Operation of the equipment may cause interference with radio communications, in which case the user at his own expense will be required to take whatever measures may be required to correct this interference.

General Statement for EVMs including a radio

User Power/Frequency Use Obligations: This radio is intended for development/professional use only in legally allocated frequency and power limits. Any use of radio frequencies and/or power availability of this EVM and its development application(s) must comply with local laws governing radio spectrum allocation and power limits for this evaluation module. It is the user's sole responsibility to only operate this radio in legally acceptable frequency space and within legally mandated power limitations. Any exceptions to this are strictly prohibited and unauthorized by Texas Instruments unless user has obtained appropriate experimental/development licenses from local regulatory authorities, which is responsibility of user including its acceptable authorization.

For EVMs annotated as FCC – FEDERAL COMMUNICATIONS COMMISSION Part 15 Compliant

Caution

This device complies with part 15 of the FCC Rules. Operation is subject to the following two conditions: (1) This device may not cause harmful interference, and (2) this device must accept any interference received, including interference that may cause undesired operation.

Changes or modifications not expressly approved by the party responsible for compliance could void the user's authority to operate the equipment.

FCC Interference Statement for Class A EVM devices

This equipment has been tested and found to comply with the limits for a Class A digital device, pursuant to part 15 of the FCC Rules. These limits are designed to provide reasonable protection against harmful interference when the equipment is operated in a commercial environment. This equipment generates, uses, and can radiate radio frequency energy and, if not installed and used in accordance with the instruction manual, may cause harmful interference to radio communications. Operation of this equipment in a residential area is likely to cause harmful interference in which case the user will be required to correct the interference at his own expense.

FCC Interference Statement for Class B EVM devices

This equipment has been tested and found to comply with the limits for a Class B digital device, pursuant to part 15 of the FCC Rules. These limits are designed to provide reasonable protection against harmful interference in a residential installation. This equipment generates, uses and can radiate radio frequency energy and, if not installed and used in accordance with the instructions, may cause harmful interference to radio communications. However, there is no guarantee that interference will not occur in a particular installation. If this equipment does cause harmful interference to radio or television reception, which can be determined by turning the equipment off and on, the user is encouraged to try to correct the interference by one or more of the following measures:

- Reorient or relocate the receiving antenna.
- Increase the separation between the equipment and receiver.
- Connect the equipment into an outlet on a circuit different from that to which the receiver is connected.
- Consult the dealer or an experienced radio/TV technician for help.

For EVMs annotated as IC – INDUSTRY CANADA Compliant

This Class A or B digital apparatus complies with Canadian ICES-003.

Changes or modifications not expressly approved by the party responsible for compliance could void the user's authority to operate the equipment.

Concerning EVMs including radio transmitters

This device complies with Industry Canada licence-exempt RSS standard(s). Operation is subject to the following two conditions: (1) this device may not cause interference, and (2) this device must accept any interference, including interference that may cause undesired operation of the device.

Concerning EVMs including detachable antennas

Under Industry Canada regulations, this radio transmitter may only operate using an antenna of a type and maximum (or lesser) gain approved for the transmitter by Industry Canada. To reduce potential radio interference to other users, the antenna type and its gain should be so chosen that the equivalent isotropically radiated power (e.i.r.p.) is not more than that necessary for successful communication.

This radio transmitter has been approved by Industry Canada to operate with the antenna types listed in the user guide with the maximum permissible gain and required antenna impedance for each antenna type indicated. Antenna types not included in this list, having a gain greater than the maximum gain indicated for that type, are strictly prohibited for use with this device.

Cet appareil numérique de la classe A ou B est conforme à la norme NMB-003 du Canada.

Les changements ou les modifications pas expressément approuvés par la partie responsable de la conformité ont pu vider l'autorité de l'utilisateur pour actionner l'équipement.

Concernant les EVMs avec appareils radio

Le présent appareil est conforme aux CNR d'Industrie Canada applicables aux appareils radio exempts de licence. L'exploitation est autorisée aux deux conditions suivantes : (1) l'appareil ne doit pas produire de brouillage, et (2) l'utilisateur de l'appareil doit accepter tout brouillage radioélectrique subi, même si le brouillage est susceptible d'en compromettre le fonctionnement.

Concernant les EVMs avec antennes détachables

Conformément à la réglementation d'Industrie Canada, le présent émetteur radio peut fonctionner avec une antenne d'un type et d'un gain maximal (ou inférieur) approuvé pour l'émetteur par Industrie Canada. Dans le but de réduire les risques de brouillage radioélectrique à l'intention des autres utilisateurs, il faut choisir le type d'antenne et son gain de sorte que la puissance isotrope rayonnée équivalente (p.i.r.e.) ne dépasse pas l'intensité nécessaire à l'établissement d'une communication satisfaisante.

Le présent émetteur radio a été approuvé par Industrie Canada pour fonctionner avec les types d'antenne énumérés dans le manuel d'usage et ayant un gain admissible maximal et l'impédance requise pour chaque type d'antenne. Les types d'antenne non inclus dans cette liste, ou dont le gain est supérieur au gain maximal indiqué, sont strictement interdits pour l'exploitation de l'émetteur.

【Important Notice for Users of EVMs for RF Products in Japan】

This development kit is NOT certified as Confirming to Technical Regulations of Radio Law of Japan

If you use this product in Japan, you are required by Radio Law of Japan to follow the instructions below with respect to this product:

1. Use this product in a shielded room or any other test facility as defined in the notification #173 issued by Ministry of Internal Affairs and Communications on March 28, 2006, based on Sub-section 1.1 of Article 6 of the Ministry's Rule for Enforcement of Radio Law of Japan,
2. Use this product only after you obtained the license of Test Radio Station as provided in Radio Law of Japan with respect to this product, or
3. Use of this product only after you obtained the Technical Regulations Conformity Certification as provided in Radio Law of Japan with respect to this product. Also, please do not transfer this product, unless you give the same notice above to the transferee. Please note that if you could not follow the instructions above, you will be subject to penalties of Radio Law of Japan.

Texas Instruments Japan Limited
(address) 24-1, Nishi-Shinjuku 6 chome, Shinjuku-ku, Tokyo, Japan

<http://www.tij.co.jp>

【無線電波を送信する製品の開発キットをお使いになる際の注意事項】

本開発キットは技術基準適合証明を受けておりません。

本製品のご使用に際しては、電波法遵守のため、以下のいずれかの措置を取っていただく必要がありますのでご注意ください。

1. 電波法施行規則第6条第1項第1号に基づく平成18年3月28日総務省告示第173号で定められた電波暗室等の試験設備でご使用いただく。
2. 実験局の免許を取得後ご使用いただく。
3. 技術基準適合証明を取得後ご使用いただく。

なお、本製品は、上記の「ご使用にあたっての注意」を譲渡先、移転先に通知しない限り、譲渡、移転できないものとします。

上記を遵守頂けない場合は、電波法の罰則が適用される可能性があることをご留意ください。

日本テキサス・インスツルメンツ株式会社
東京都新宿区西新宿6丁目24番1号
西新宿三井ビル

<http://www.tij.co.jp>

EVALUATION BOARD/KIT/MODULE (EVM) WARNINGS, RESTRICTIONS AND DISCLAIMERS

For Feasibility Evaluation Only, in Laboratory/Development Environments. Unless otherwise indicated, this EVM is not a finished electrical equipment and not intended for consumer use. It is intended solely for use for preliminary feasibility evaluation in laboratory/development environments by technically qualified electronics experts who are familiar with the dangers and application risks associated with handling electrical mechanical components, systems and subsystems. It should not be used as all or part of a finished end product.

Your Sole Responsibility and Risk. You acknowledge, represent and agree that:

1. You have unique knowledge concerning Federal, State and local regulatory requirements (including but not limited to Food and Drug Administration regulations, if applicable) which relate to your products and which relate to your use (and/or that of your employees, affiliates, contractors or designees) of the EVM for evaluation, testing and other purposes.
2. You have full and exclusive responsibility to assure the safety and compliance of your products with all such laws and other applicable regulatory requirements, and also to assure the safety of any activities to be conducted by you and/or your employees, affiliates, contractors or designees, using the EVM. Further, you are responsible to assure that any interfaces (electronic and/or mechanical) between the EVM and any human body are designed with suitable isolation and means to safely limit accessible leakage currents to minimize the risk of electrical shock hazard.
3. Since the EVM is not a completed product, it may not meet all applicable regulatory and safety compliance standards (such as UL, CSA, VDE, CE, RoHS and WEEE) which may normally be associated with similar items. You assume full responsibility to determine and/or assure compliance with any such standards and related certifications as may be applicable. You will employ reasonable safeguards to ensure that your use of the EVM will not result in any property damage, injury or death, even if the EVM should fail to perform as described or expected.
4. You will take care of proper disposal and recycling of the EVM's electronic components and packing materials.

Certain Instructions. It is important to operate this EVM within TI's recommended specifications and environmental considerations per the user guidelines. Exceeding the specified EVM ratings (including but not limited to input and output voltage, current, power, and environmental ranges) may cause property damage, personal injury or death. If there are questions concerning these ratings please contact a TI field representative prior to connecting interface electronics including input power and intended loads. Any loads applied outside of the specified output range may result in unintended and/or inaccurate operation and/or possible permanent damage to the EVM and/or interface electronics. Please consult the EVM User's Guide prior to connecting any load to the EVM output. If there is uncertainty as to the load specification, please contact a TI field representative. During normal operation, some circuit components may have case temperatures greater than 60°C as long as the input and output are maintained at a normal ambient operating temperature. These components include but are not limited to linear regulators, switching transistors, pass transistors, and current sense resistors which can be identified using the EVM schematic located in the EVM User's Guide. When placing measurement probes near these devices during normal operation, please be aware that these devices may be very warm to the touch. As with all electronic evaluation tools, only qualified personnel knowledgeable in electronic measurement and diagnostics normally found in development environments should use these EVMs.

Agreement to Defend, Indemnify and Hold Harmless. You agree to defend, indemnify and hold TI, its licensors and their representatives harmless from and against any and all claims, damages, losses, expenses, costs and liabilities (collectively, "Claims") arising out of or in connection with any use of the EVM that is not in accordance with the terms of the agreement. This obligation shall apply whether Claims arise under law of tort or contract or any other legal theory, and even if the EVM fails to perform as described or expected.

Safety-Critical or Life-Critical Applications. If you intend to evaluate the components for possible use in safety critical applications (such as life support) where a failure of the TI product would reasonably be expected to cause severe personal injury or death, such as devices which are classified as FDA Class III or similar classification, then you must specifically notify TI of such intent and enter into a separate Assurance and Indemnity Agreement.

Mailing Address: Texas Instruments, Post Office Box 655303, Dallas, Texas 75265
Copyright © 2013, Texas Instruments Incorporated

IMPORTANT NOTICE

Texas Instruments Incorporated and its subsidiaries (TI) reserve the right to make corrections, enhancements, improvements and other changes to its semiconductor products and services per JESD46, latest issue, and to discontinue any product or service per JESD48, latest issue. Buyers should obtain the latest relevant information before placing orders and should verify that such information is current and complete. All semiconductor products (also referred to herein as "components") are sold subject to TI's terms and conditions of sale supplied at the time of order acknowledgment.

TI warrants performance of its components to the specifications applicable at the time of sale, in accordance with the warranty in TI's terms and conditions of sale of semiconductor products. Testing and other quality control techniques are used to the extent TI deems necessary to support this warranty. Except where mandated by applicable law, testing of all parameters of each component is not necessarily performed.

TI assumes no liability for applications assistance or the design of Buyers' products. Buyers are responsible for their products and applications using TI components. To minimize the risks associated with Buyers' products and applications, Buyers should provide adequate design and operating safeguards.

TI does not warrant or represent that any license, either express or implied, is granted under any patent right, copyright, mask work right, or other intellectual property right relating to any combination, machine, or process in which TI components or services are used. Information published by TI regarding third-party products or services does not constitute a license to use such products or services or a warranty or endorsement thereof. Use of such information may require a license from a third party under the patents or other intellectual property of the third party, or a license from TI under the patents or other intellectual property of TI.

Reproduction of significant portions of TI information in TI data books or data sheets is permissible only if reproduction is without alteration and is accompanied by all associated warranties, conditions, limitations, and notices. TI is not responsible or liable for such altered documentation. Information of third parties may be subject to additional restrictions.

Resale of TI components or services with statements different from or beyond the parameters stated by TI for that component or service voids all express and any implied warranties for the associated TI component or service and is an unfair and deceptive business practice. TI is not responsible or liable for any such statements.

Buyer acknowledges and agrees that it is solely responsible for compliance with all legal, regulatory and safety-related requirements concerning its products, and any use of TI components in its applications, notwithstanding any applications-related information or support that may be provided by TI. Buyer represents and agrees that it has all the necessary expertise to create and implement safeguards which anticipate dangerous consequences of failures, monitor failures and their consequences, lessen the likelihood of failures that might cause harm and take appropriate remedial actions. Buyer will fully indemnify TI and its representatives against any damages arising out of the use of any TI components in safety-critical applications.

In some cases, TI components may be promoted specifically to facilitate safety-related applications. With such components, TI's goal is to help enable customers to design and create their own end-product solutions that meet applicable functional safety standards and requirements. Nonetheless, such components are subject to these terms.

No TI components are authorized for use in FDA Class III (or similar life-critical medical equipment) unless authorized officers of the parties have executed a special agreement specifically governing such use.

Only those TI components which TI has specifically designated as military grade or "enhanced plastic" are designed and intended for use in military/aerospace applications or environments. Buyer acknowledges and agrees that any military or aerospace use of TI components which have **not** been so designated is solely at the Buyer's risk, and that Buyer is solely responsible for compliance with all legal and regulatory requirements in connection with such use.

TI has specifically designated certain components as meeting ISO/TS16949 requirements, mainly for automotive use. In any case of use of non-designated products, TI will not be responsible for any failure to meet ISO/TS16949.

Products

Audio	www.ti.com/audio
Amplifiers	amplifier.ti.com
Data Converters	dataconverter.ti.com
DLP® Products	www.dlp.com
DSP	dsp.ti.com
Clocks and Timers	www.ti.com/clocks
Interface	interface.ti.com
Logic	logic.ti.com
Power Mgmt	power.ti.com
Microcontrollers	microcontroller.ti.com
RFID	www.ti-rfid.com
OMAP Applications Processors	www.ti.com/omap
Wireless Connectivity	www.ti.com/wirelessconnectivity

Applications

Automotive and Transportation	www.ti.com/automotive
Communications and Telecom	www.ti.com/communications
Computers and Peripherals	www.ti.com/computers
Consumer Electronics	www.ti.com/consumer-apps
Energy and Lighting	www.ti.com/energy
Industrial	www.ti.com/industrial
Medical	www.ti.com/medical
Security	www.ti.com/security
Space, Avionics and Defense	www.ti.com/space-avionics-defense
Video and Imaging	www.ti.com/video

TI E2E Community

e2e.ti.com