

— FE as a main breaker in A-Series™ Panelboards: Expanding GE's selectivity offering. The FE main breaker in A-Series allows full instantaneous selectivity, which can be coordinated with upstream and downstream GE breakers.

— A-Series Branch Circuit Monitoring (BCM): This new energy management product allows for monitoring key electrical parameters down to a branch circuit level. This product is factory installed which makes for a clean installation and reduced labor in the field.

— AS style A-Series panel: New AE subtype panel, AS, allows for the combination of expanded selectivity and fully rated solution up to 65kAIC at 480V. This solution also decreases overall footprints of our panelboard, which has an important aspect of current day installations.

## A-Series™ Panelboards

Applications.....	11-3
Types.....	11-4
Terminal Lugs.....	11-7
Pricing and Ordering.....	11-8
Column Panels.....	11-9
Column – Field Installed Kits/Replacement Parts/Enclosures.....	11-10
Lighting Control Panel—Remote Operated Circuit Breakers.....	11-11
Pro-Stock Panelboards – Unassembled.....	11-13
Product Options.....	11-19
Accessories.....	11-20
Power Panelboards.....	11-21
Branch Circuit Monitoring.....	11-23

## Spectra™ Series Panelboards .....11-24

Fusible Switches Load and Interrupting Ratings.....	11-25
Merchandisable Kits and Sizing Information.....	11-27
Terminal Lugs.....	11-28
PCU Selection.....	11-29
Interior, Enclosure Options.....	11-30
Integrated Submetering Panelboard.....	11-32
Renewal Parts Modular Concept.....	11-33
Renewal Parts Circuit Breaker Sizing.....	11-34
Replacement Boxes and Fronts.....	11-35
Renewal Parts Product Number Structure.....	11-37
Renewal Parts – Mounting Hardware.....	11-40
Renewal Parts – Main Lug Modules; Neutral and Ground Kits.....	11-45
Renewal Parts – Accessories.....	11-46
Renewal Parts – Interiors, Boxes and Fronts.....	11-47
Renewal Parts – Type SCP Panelboards.....	11-48
Renewal Parts – Type CCB and QMR Panelboards.....	11-49

## Available Publications .....11-52



This page left blank intentionally.



# Panelboards

## A-Series™ Panelboards Applications

### Standards

All GE panelboards meet the latest revision of the following standards.

- National Electrical Code-Ref. Article 384.
- UL67 panelboards: UL50 cabinets and boxes. UL943 GFCI.
- UL489 molded case circuit breakers. UL98 fusible switches.
- CSA or C-uL listing for Spectra™ Series Power Panelboards.
- C-uL Listing for A-Series™ non-service entrance panelboards
- International Building Code Seismic Zone 3 and 4.
- California Building Code Seismic Zone 4.
  
- NEMA PB1.
- Federal Specifications
  - Panelboards, W-P-115c.
    - Type 1—Circuit breaker equipped
    - Class 1—Panelboards
    - Class 2—Load centers
  - Molded case circuit breakers, WC-375B/GEN.
  - Fusible switches, W-S-865c.

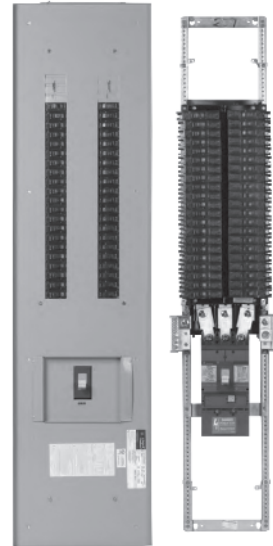

### Application

The following classifications and limitations of panelboards have been established by the Underwriters Laboratories and the National Electrical Code. Note— “an overcurrent protective device is a circuit breaker pole or single fuse”. Panelboards have no fire wall ratings. All 50/60 Hz rated. There is no limitation as to the number and rating of branch circuits, except as determined by available enclosures.

### Interrupting Ratings—Circuit Breakers

Panelboards have integrated short circuit ratings. When fully rated, the rating is that of the lowest rated device in the panelboard. When series connected rated, the rating is that of the main device in panel (or remote line side protected device) and branch-tested/UL Listed combination.

### Short-Circuit Ratings—Fusible Switch Units

The interrupting rating of the fuse must equal or exceed the short-circuit rating of the switch. If it is lower, then the interrupting rating of the switch is the same as the fuse. Switches have no short-circuit rating if renewable fuses are used.

### Seismic Ratings

All A-Series™ Lighting Panels and Spectra™ Power Panels have been tested and certified to meet the International Building Code (IBC) Zone 3 and Zone 4 as well as the California Building Code (CBC) Zone 4.

### Features

- Symmetrical design, no required top or bottom mountings
- Wide, easy-to-install galvanized enclosures with removable endwalls
- Flush or surface mounting
- Standard concealed mounting hardware and hinges
- Interiors that allow “straight-in” wiring
- Split neutral
- Field-installable, UL Listed, 200% neutral for non-linear loads
- Branch-bus direct connection
- Captive hardware on branch breakers
- Short circuit ratings allow up to 100KA @ 480Y/277Vac; 200KA @ 240Vac
- Main bus ratings of 125 to 800 amps copper, 125 to 600 amps aluminum
- Spectra RMS and vertically mounted main circuit breakers available
- Bus-connected TVSS for maximum surge protection
- Optional door-in-door or front-hinged-to-box door
- Enclosures available in NEMA Type 1, Type 3R/12, Type 4/4X



# Panelboards

## A-Series™ Panelboards

### Types

## Section 11

### Type AL

---

#### Service Information:

- 1P, 3W-120/240 Vac
- 3P, 3W-240 Vac
- 3P, 4W-240/120 Vac, 208/120 Vac

#### Mains

##### Breakers:

- 100A-THQB, THHQB, TEY, SE, FE
- 225A-TQD, THQD, SF, FE
- 400A-TJD, SG
- 600A-SG
- 800A-SK

##### Main Lug:

- 125-800A

##### Branch Breakers (Plug-in):

- Amperage-15-100A
- Poles-1, 2, 3
- Types-THQL, THHQL, TXQL

#### Enclosures

- Length-25.5, 31.5, 37.5, 43.5, 49.5, 55.5, 64.5, 76.5, 82.5, 88.5
- Width-20"
- Depth-5.81"

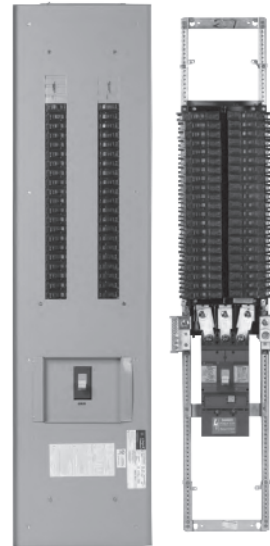

### Type AQ

---

#### Service Information:

- 1P, 3W-120/240 Vac
- 3P, 3W-240 Vac
- 3P, 4W-240/120 Vac, 208/120 Vac
- Fully Rated: 65kAIC at 240V
- Series Rated: 200kAIC at 240V

#### Mains

##### Breakers:

- 100A-THQB, THHQB, TEY, SE, FE
- 225A-TQD, THQD, SF, FE
- 400A-TJD, SG, FG
- 600A-SG
- 800A-SK

##### Main Lug:

- 125-800A

##### Branch Breakers (Bolt-on):

- Amperage-15-100A
- Poles-1, 2, 3
- Types-THQB, THHQB, TXQB

#### Enclosures

- Length-25.5, 31.5, 37.5, 43.5, 49.5, 55.5, 64.5, 76.5, 82.5, 88.5
- Width-20"
- Depth-5.81"



# Panelboards

## A-Series™ Panelboards

### Types

### Type AE (includes subtype AS)

---

#### Service Information:

- 1P, 3W-120/240 Vac, 125/250 Vdc
- 3P, 3W-240 Vac
- 3P, 4W-480/277 Vac, 208/120 Vac, 240/120 Vac
- Fully Rated: 65kAIC at 480Y/277V, 100kAIC at 240V
- Series Rated: 100kAIC at 480V

#### Mains

##### Breakers:

- 100A-TEY, SE, FE
- 225A-TFJ, SF, FE
- 400A-TJJ, SG, FG
- 600A-SG
- 800A-SK

##### Main Lug:

- 125-800A

##### Branch Breakers (Bolt-on):

- Amperage-15-100A
- Poles-1, 2, 3
- Types-TEY, TEYF, **TEYD, TEYH, TEYL**
- Amperage-110A, 125A**
- Poles-2, 3**
- Types-**TEYD, TEYH, TEYL**

##### Enclosures

- Length-25.5, 31.5, 37.5, 43.5, 49.5, 55.5, 64.5, 76.5, 82.5, 88.5
- Width-20"
- Depth-5.81"

Note: Bold items are features of AS Panels

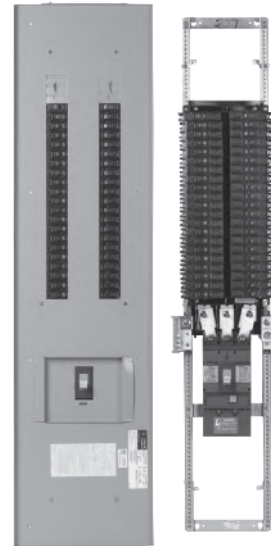

### Type AD

---

#### Service Information:

- 3P, 3W-480 Vac, 600 Vac
- 3P, 4W-208/120 Vac, 480/277 Vac, 600/347 Vac
- Fully Rated: 35kAIC at 600Y/347V, 100kAIC at 480V
- Series Rated: 35kAIC at 600Y/347V

#### Mains

##### Breakers:

- 150A-THED, SE
- 225A-TFJ, SF
- 400A-TJJ, SG
- 600A-SG
- 800A-SK

##### Main Lug:

- 150-800A

##### Branch Breakers (Bolt-on):

- Amperage-15-100A (1P, 2P)
- 15-150A (3P)
- 220A Max. double branch
- Types-TED, SE, FB

##### Enclosures

- Length-31.5, 37.5, 43.5, 49.5, 55.5, 64.5, 76.5, 82.5, 88.5
- Width-20"
- Depth-5.81"



# Panelboards

## A-Series™ Panelboards Types

# Section 11

### Panelboard Types

Item	A-Series					Column Type Panels			Distribution Panels
	AL Page 11-4	AQ Page 11-4	AE/AS Page 11-5	AD/AD Plus Page 11-5	Lighting Control Panel Page 11-11	ALC Page 11-9	AQC Page 11-9	AEC Page 11-9	Spectra Page 11-24
Max. Voltage	240Vac	240Vac	480V/277Vac <sup>1</sup> 125/250Vdc	600Vac	480V/277Vac	240Vac	240Vac	480/277Vac 125/250Vdc	600Vac 250Vdc
Max. Main Lug Amperes	800A	800A	800A	800A	400A	225A	225A	225A	1200A
Max. Main Breaker or Switch Amperes	800A	800A	800A	800A	400A	225A	225A	225A	1200A
Main Devices	THQB, THHQB, TQD, THQD, TEY, TJD, TFJ		TEY, TFJ, TJJ, TEYF, TEYD, TEYH, TEYL	THED, TFJ, TJJ	TEY, SE, TFJ, SF, TJJ, SG	THQB, THHQB, TQD, THQD, TEY, TFJ, SE, SF		TEY, TFJ, SE, SF	SF, SG, SK, ADS Switches, FB, FC, FE, FG
Branches Max. Amps	100A	100A	125A	100A-1 ph, 2ph 150A-3 ph	100A	100A	100A	80A-8 1/2 Box 80A-7 1/2 Box	1200A
Branch Devices	THQL, THHQL	THQB, THHQB, TXQB (Bolt-on)	TEY, TEYF, TEYD <sup>5</sup> , TEYH <sup>5</sup> , TEYL <sup>5</sup>	FB, TED, THED, SE	TEYRC, TEY, THQBGF	THQL, THHQL	THQB, THHQB, TXQB (Bolt on)	TEY	TED, SE, SF, SG, SK, THQB, THHQB, TEY, TQD, ADS Switches, FB, FC, FE, FG
Subfeeds Max. Amps (100% Rated)	225	225	225	225	225	150	150	150	—
Subfeed Breaker Types	TQD, THQD	TQD, THQD	TED, TFJ, SE, SF	TED, TFJ, SE, SF	TED, TFJ, SE, SF	TQD, THQD	TQD, THQD	TED	—

### A-Series™ Standard Main Breaker Types and Ratings

IC Ratings	Voltage	Panel Type																
		AQ/AL				AE / Lighting Control Panel					AD / AD Plus							
		100A	225A	400A <sup>3</sup>	600A <sup>3</sup>	800A <sup>3</sup>	150A	225A	400A	600A	800A	150A	225A	400A	600A	800A		
10	240	THQB	TQD/TFJ	SKHA8														
22	240	THHQB	THQD	TJD	SGHA6													
65	240	TEY	SFHA	SGHA4	SGHA6	SFHA <sup>4</sup>			SGHA4 <sup>4</sup>	SGHA6								
100	240	SEL/TEYL	SFL	SGL	SGL6													
200	240	SEP	SFP	SGPA4														
14 <sup>2</sup>	480V/277						TEY <sup>4</sup>	TFJ <sup>4</sup>	SGHA/TJJ <sup>4</sup>	SGHA6	SKHA8	TED	TFJ	TJJ				
35	480V/277											SEHA	SFHA	SGHA4	SGHA6			
18																		
25							SEHA <sup>4</sup> /TEYD	SFHA <sup>4</sup>			SEHA	SFHA						
65	480V/277						SELA <sup>4</sup> /TEYL	SFLA <sup>4</sup>	SGLA4	SGLA6								
100	480V/277						SEPA <sup>4</sup>	SFPA			SEPA	SFPA	SGPA4	SGPA6				
14 <sup>2</sup>	480											TED	TFJ	TJJ	SGHA6			
65	480											SELA	SFLA	SGLA4	SGLA6			
100	480											SEPA	SFPA	SGPA4	SGLA6			
18 <sup>2</sup>	600											THED	TFJ	TJJ	SGHA6	SKHA6		
25	600											SELA	SFLA	SGHA4	SGHA6			
35k <sup>2</sup>	600V/347											SEPA	SFPA	SGPA4	SGPA6			

<sup>1</sup>AE Panels are suitable for use on 3-PH, 3W applications when derived from 3PH, 4W 480V/277 service where the neutral is not connected to the panel. For 3ph-Delta use AD Panels.

<sup>2</sup>Not series rated.

<sup>3</sup>Not available in column panelboards.

<sup>4</sup>Light Control Panel ratings.

<sup>5</sup>For installation in AS panels only.



# Panelboards A-Series™ Panelboards Terminal Lugs

## Section 11

### Molded Case Circuit Breakers

Circuit Breaker Frame					Terminal Lugs (Cu-Al)				
Standard	Hi-Break	Tri-Break™	Current Limiting	High Interrupting	Poles	No. Per Pole	Product Number	Wire—Cu-Al (Unless otherwise noted)	
								Per Lug	Range
THQL	TXQL, THHQL	—	—	—	1,2,3	1	Fixed to Breaker Terminal	1	(15-30A) #14-4 Cu or #12-4 Al (35-100A) #14-1/0 Cu or #12-1/0 Al
THQB	TXQB, THHQB	—	—	—	1,2,3				
TEY	—	—	—	—	1,2,3	1	—	1	(15-25A) #14-#12 Cu or #12-#10 Al (30-60A) #10-#6 Cu or #8-#4 Al (70-100A) #4-#1 Cu or #2-1/0 Al
TEB	—	—	—	—	1,2,3	1	TCAL14	1	(15-30A, TCAL14)-#14-8
TED	THED <sup>1</sup>	—	—	—	1		TCAL12		(30-60A, TCAL12)-#14-3 Cu, #12-1 Al
TED4	—	—	—	—	2-3		TCAL12A		(70-90A, TCAL12A)-#6-2/0 Cu, #4-2/0 Al
TED6	THED	—	—	—	2-3		TCAL15		(100-150A, TCAL15)-#3-3/0
—	—	—	FBV FBN FBH FBL	—	1,2,3		FCAL12 FCAL13 FCAL14		(15-20A) #14-#12 Cu or #10-#12 Al (35-60A) #10-#6 Cu or #8-#4 Al (70-100A) #4-#1 Cu or #2-1/0 Al
—	—	—	FCS FCV FCN FCH FCL	—	2,3	FCALK12 FCALK13 FCALK14	(15-20A) #14-#12 Cu or #10-#12 Al (35-60A) #10-#6 Cu or #8-#4 Al (70-100A) #4-#1 Cu or #2-1/0 Al		
SEDA	SEHA	—	SELA SEPA	—	2-3	1	TCAL18	1	#12-3/0 Cu, #12-3/0 Al
—	—	—	FES1T FEV1T FEN1T FEH1T FEL1T	—	2-3	1	FCALK15	1	#12-3/0 Cu, #14-1/0 Al
—	—	—	FES1E FEV1E FEN1E FEH1E FEL1E	—	2-3	1	FCALK15	1	#12-3/0 Cu, #14-1/0 Al
TQD	THQD	—	—	—	2-3	1	TCAL25	1	#1-300kcmil
SFHA	—	—	SFLA SFPA	—	2-3	1	TCAL29	1	#8-350kcmil
TFJ, TFK	THFK	—	—	—	2-3	1	TCAL24, 26	1	#4-300kcmil
—	—	—	FES2T FEV2T FEN2T FEH2T FEL2T	—	2-3	1	FCALK16	1	#8-250kcmil Cu, #8-250kcmil
—	—	—	FES2E FEV2E FEN2E FEH2E FEL2E	—	2-3	1	FCALK16	1	#8-250kcmil Cu, #8-250kcmil
SGDA	—	—	SGL	—	2	1	TCLK265 <sup>2</sup>	—	2(2/0-400kcmil Cu) or 2(2/0-500kcmil Al) or #6-600kcmil
SGHA	—	—	SGP	—	3	1	TCLK365 <sup>2</sup>	—	2(2/0-400kcmil Cu) or 2(2/0-500kcmil Al) or #6-600kcmil
—	—	—	FGV2	—	2-3	1	FCALK318H	—	Top hole #8-400kcmil Cu or #6-500kcmil Al Bottom hole #2/0-600kcmil Cu & Al
—	—	—	FGN2 FGH2 FGL2 FGP2	—	2-3	1	FCALK318H	—	Top hole #8-400kcmil Cu or #6-500kcmil Al Bottom hole #2/0-600kcmil Cu & Al
—	—	—	FGV4	—	2-3	1	FCALK318H	—	Top hole #8-400kcmil Cu or #6-500kcmil Al Bottom hole #2/0-600kcmil Cu & Al
—	—	—	FGN4 FGH4 FGL4 FGP4	—	2-3	1	FCALK318H	—	Top hole #8-400kcmil Cu or #6-500kcmil Al Bottom hole #2/0-600kcmil Cu & Al
—	—	—	FGV6	—	2-3	1	FCALK318H	—	Top hole #8-400kcmil Cu or #6-500kcmil Al Bottom hole #2/0-600kcmil Cu & Al
—	—	—	FGN6 FGH6 FGL6 FGP6	—	2-3	1	FCALK318H	—	Top hole #8-400kcmil Cu or #6-500kcmil Al Bottom hole #2/0-600kcmil Cu & Al
TJJ, TJK4	THJK4	TB4	—	—	2-3	1	TCAL43	1	#6-600kcmil or 2-(2/0-250kcmil)
TJD	—	—	—	—	2-3	1	TCAL43	1	#6-600kcmil or 2-(2/0-250kcmil)
TJK6	THJK6, THJ4V	—	—	—	2-3	1	TCAL43	1	#6-600kcmil or 2-(2/0-250kcmil)
—	—	TB6	—	—	3	1	TCAL63	2	250-350kcmil, Cu, or 350-500kcmil, Al
—	—	—	—	—	3	1	TCAL61	2	2/0-500kcmil
SKHA8	THKM8	—	—	SKLA8	2-3	1	TCAL41	1	#4-600kcmil or 2-(1/0-250kcmil)
TKM8 <sup>4</sup>	—	—	—	SKPA8	—	—	TCAL61	2	2/0-500kcmil
—	—	—	—	—	—	—	TCAL81	3	3/0-500kcmil
—	—	—	—	Load End	—	1	TCAL91	3	3/0-500kcmil
—	—	TB8	—	—	3	1	TCAL81	3	3/0-500kcmil
SKHA12,	THKM12	—	—	SKLA12,	2-3	1	TCAL81	3	3/0-500kcmil
TKM12 <sup>4</sup>	—	—	—	SKPA12	—	—	TCAL121	4	250-350kcmil Cu or 350-500kcmil Al
—	—	—	—	Load End	2-3	1	TCAL131	4	250-350kcmil Cu or 350-500kcmil Al
—	—	TB1	THLC1	—	3	1	TCAL12	1	(15-60A, TCAL12)#14-#3 Cu or #12-#1 Al (70-100A, TCAL12A)#6-2/0 Cu or #4-2/0 Al (100-150A, TCAL15)#3-3/0 Cu or #1-3/0 Al
—	—	—	THLC2	—	3	1	TCAL15	1	(125-225A, TCAL27)#4-300kcmil
—	—	—	THLC4	TLB4 <sup>4</sup>	3	1	TCAL27	1	(125-225A, TCAL27)#4-300kcmil
—	—	—	—	—	3	1	TCLK43 <sup>3</sup>	—	3/0-500kcmil or 2-(3/0-250kcmil)

<sup>1</sup>One-pole THED frame available only in 15-30 amp trip.

<sup>2</sup>Lug kit—includes line or load end cover.

<sup>3</sup>Three-pole lug assembly suitable for line or load end.

<sup>4</sup>For replacement use only.

### ADS Fusible Switch Module Terminations (CU/AL Mechanical)<sup>5</sup>

Amp Rating	Voltage	Wire Size (CU/AL)	# Wires Per Lug	# Lugs Per Phase
30	240/600	#2-#14	1	1
60	240	#2-#14	1	1
60	600	#14-I/O	1	1
100	240/600	#14-I/O	1	1
200	240/600	#6-250kcmil	1	1
400	240/600	I/O-250kcmil or #2-600kcmil	2 or 1	1
600	240/600	I/O-250kcmil or #2-600kcmil	2 or 1	1
800	600	I/O-250kcmil or #2-600kcmil	2 or 1	1
1200	600	I/O-250kcmil or #2-600kcmil	2 or 1	1

<sup>5</sup>For optional mechanical or compression lugs refer to GET-7006.



#### Information Required to Price and Order a Panelboard

---

- Short-circuit Rating (10kA, 18kA, etc.)
- Service Entrance Label (Yes) or (No)
- Mark(s) (LPA, MDP, RPC, etc.)
- Service (3-ph, 4-w 208Y/120; 3-ph, 3-w 480 volts, etc.)
- Entrance of Incoming Line (Top) or (Bottom).  
(Bottom Supplied as Standard)
- Trim (Surface) or (Flush)
- Incoming Wire Size (500kcmil, 250kcmil, etc.)
- Incoming Number of Wires per phase (1, 2, 3, etc.)
- Wire Material (Copper or Aluminum)
- Main Type (Main Lugs Only, Circuit Breaker, Fusible Switch, etc.)
- Amperage of Main Bus
- Frame of Main Circuit Breaker (SG, SK, TJK, etc.) (if applicable)
- Options to Mains (Shunt Trip, Lighting Contactor, etc.)
- Equipment Ground (Optional)
- Branches
  - Amp Rating (20, 30, 50, etc.)
  - Poles (1, 2, or 3)
  - Frame (THQB, TED, etc.)
  - Quantity (1, 10, 15, etc.)
- Options:
  - Interior (Copper bus, 200% rated neutral, etc.)
  - Box (Painted, Increased Gutter, etc.)
  - Front (Door in Door, etc.)
  - Ground Fault Protection (Yes) or (No)
- Type of Panel (AQ, AE, Spectra™ Bolt-on, etc.)

#### How to Price Factory Assembled Panelboards

---

Main Price (or Interior Price for A-Series™) + Branch Circuits + Options = Total List of Panelboard. The sum of these list prices is the total list for the complete panelboard including box and front.

**Please refer to Speedi for quoting, pricing and ordering GE panels**

#### How to Lay Out Factory Assembled Panelboards

---

—Multi-section panels must have a main circuit breaker or main lugs in each section. Double (dual) main lugs or thru-feed lugs must be added as required in all but the last section.

**Please refer to Speedi for quoting, pricing and ordering GE panels**

#### How to select a Pro-Stock, unassembled panelboard

---

**Total the following components:**

- Interior
- Box (add ground bars as required)
- Front
- Main breaker or lug kit
- Subfeed breaker or feed thru lug kit (if required)
- Branch Breakers (from Section 3)
- Accessories (200% neutral, service entrance etc.)

Please consult your local distributor for net pricing and current stock levels.

For additional details on selecting Pro-Stock panelboards, please refer to publication DEP-104.





# Panelboards

## A-Series™ Panelboards

### Column Panels

#### Type ALC

---

**Service Information:**

1P, 3W-120/240 Vac  
3P, 4W-208/120 Vac, 480/277 Vac  
3P, 4W-240 Vac

**Mains****Breakers:**

100A-THQB, THHQB, TEY, SE  
225A-TQD, THQD, SF

**Main Lug:**

125-225A

**Branch Breakers (Plug-in):**

Amperage-15-100A (1P, 2P, 3P)  
Types-THQL, THHQL, TXQL

**Enclosures**

Length-37.5, 43.5, 49.5, 55.5, 64.5, 76.5  
Width-8.62"  
Depth-5.81"

#### Type AEC

---

**Service Information:**

3P, 4W-480/277 Vac

**Mains****Breakers:**

100A-TEY, SE  
225A-TFJ, SF

**Main Lug:**

125-225A

**Branch Breakers (Bolt-on):**

Amperage-15-80A (1P, 2P, 3P)  
Types-TEY

**Enclosures**

Length-37.5, 43.5, 49.5, 55.5, 64.5, 76.5  
Width-8.62"  
Depth-5.81"

#### Type AQC

---

**Service Information:**

1P, 3W-240/120 Vac  
3P, 3W-240 Vac  
3P, 4W-240 Vac

**Mains****Breakers:**

100A-THQB, THHQB, TEY, SE  
225A-TQD, THQD, SF

**Main Lug:**

125-225A

**Branch Breakers (Bolt-on):**

Amperage-15-100A (1P, 2P, 3P)  
Types-THQB, THHQB, TXQB

**Enclosures**

Length-37.5, 43.5, 49.5, 55.5, 64.5, 76.5  
Width-8.62"  
Depth-5.81"



# Panelboards A-Series™ Panelboards Column

Field Installed Kits/Replacement Parts

## Section 11

### Miscellaneous Kits

Order by Product Number from the National Service Center

Description	Product Number
Equipment Grounds:	
Standard Terminal Strip With Provision for (1) 14-8 Cu or 12-8 Al (3) 14-4 Cu or 6-4 Al	TGL2
Above terminal with Copper Strap	TGC2
Main Lug 6-2/0 Cu/Al	TGL20
Standard Isolated Insulated (1) 14-8 Cu or 12-8 Al (3) 14-4 Cu or 6-4 Al	EGS12
Above terminal with Copper Strap	EGC12
Handle Locking Devices:	
THQL, THHQL THQB, THHQB	THL103
TEY	TEYPLD1
TED	TLD3
TFJ, TFL, TLB4	TFKLD1
Padlocking Devices:	
THQL, THHQL, TXQL THQB, THHQB, TXQB	THP100
TEY	TEYPLD1
TED, TEL	TEFPLD1
TQD	TQDPLD1
TFJ, TFL	TFKPLD1
Filler Plate for Q Line and TEY Breakers	TQLFP1
Gasketing Kit	AGSK
Safety Catch for Trough Covers <sup>1</sup>	ACHK

<sup>1</sup>Standard on pull box.

### Panelboards Parts

Order from Factory

Description	Product Number
Directory Card	139C5612P2
Circuit Numbering	
Strips - 1-48	569B806G1
43-84	569B806G2
Directory Card Holder	139C5491P4

### Permanent Circuit Number Kits

Order from Factory

Product Number	Description
APN48	No's 1-48
APN84	No's 43-84



# Panelboards

## A-Series™ Panelboards

### Lighting Control Panel

480Y/277 Vac/120/208 Vac

Remote Operated Circuit Breakers

Bolt-On Factory Assembled

Three-Phase, 4-Wire Pricing

#### Service Information:

1P, 3W-120/240 Vac

3P, 4W-208/120 Vac, 480/277 Vac

#### Mains

##### Breakers:

100A-TEY, SE

225A-TFJ, SF

400A-TJJ, SG

##### Main Lug:

125-400A

##### Branch Breakers (Bolt-on):

Amperage-15-30A (1P, 2P): TEYRC

15-100A (1P, 2P, 3P): TEY

220A Max. double branch

Types- TED, SE, FB

##### Enclosures

Length-25.5 31.5, 37.5, 43.5, 49.5, 55.5, 64.5, 76.5

Width-20"

Depth-5.81"



# Panelboards

## A-Series™ Panelboards

### Lighting Control Panel

480Y/277 Vac/120/208 Vac  
Remote Operated Circuit Breaker

## Section 11

### Accessories

Description	Product Number
Programming Software PC-based start up software	ASROCBPRGM
Daylight Optimization Module Performs sunlight harvesting by measuring the amount of light and provides a control signal to a dimming mechanism to maintain a preset lighting level.	ASRGLCDOK
Remote Switch Expansion Module Provides additional 16 digital input signals to the controller for each module	ASRGLCDSK
Control Wiring Insulation Tubing Requirement per UL67 and NEC725.55, that low voltage class 2 and 3 control wiring be separated with tubing having an insulation rating equal to branch load wiring.	ASRGLCCWT



Programming Software



Dimming Module

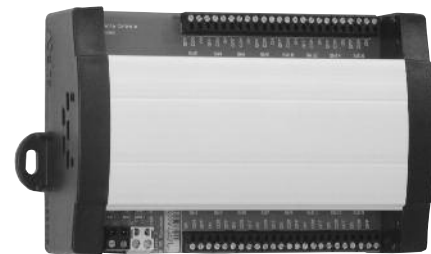

Remote Switch Module



# Panelboards

## A-Series™ Panelboards

### Pro-Stock, Unassembled Lighting Panels

100-600A

240 Vac 1 or 3 Phase or 480Y/277 Vac 3 Phase

Order by Product Number from the Customer Service Center

#### 1 Select Interior

Select the interior by bus type, panel rating and number of circuits. Identify the box/front height for use in Steps 2 and 3.

#### Copper Bus

Voltage	Rating (Amps)	No. of Circuits	Feed-thru		Non Feed-thru		TGL2 Ground Bars <sup>2,3</sup>
			Product Number <sup>1</sup>	Box/Front Height	Product Number <sup>1</sup>	Box/Front Height	
240 Vac, 1 Phase	100-225	18	AQU1182RCXAXT1B4	37.5"	AQU1182RCXAXB4	31.5"	2
		30	AQU1302RCXAXT1B4	43.5"	AQU1302RCXAXB4	37.5"	3
		42	AQU1422RCXAXT1B4	49.5"	AQU1422RCXAXB4	43.5"	4
	400	18	AQU1184RCXAXT1B4	64.5"	-	-	2
		42	AQU1424RCXAXT1B4	76.5"	AQU1424RCXAXB4	64.5"	4
		600	18	AQU1186RCXAXT1B4	64.5"	-	-
208/120 Vac, 3 Phase	100-225	18	AQU1426RCXAXT1B4	76.5"	AQU1426RCXAXB4	64.5"	4
		30	AQU3182RCXAXT1B4	37.5"	AQU3182RCXAXB4	31.5"	2
		42	AQU3302RCXAXT1B4	43.5"	AQU3302RCXAXB4	37.5"	3
	400	18	AQU3422RCXAXT1B4	49.5"	AQU3422RCXAXB4	43.5"	4
		42	AQU3184RCXAXT1B4	64.5"	-	-	2
		42	AQU3424RCXAXT1B4	76.5"	AQU3424RCXAXB4	64.5"	4
480/277 Vac, 3 Phase	100-225	18	AQU3186RCXAXT1B4	64.5"	-	-	2
		42	AQU3426RCXAXT1B4	76.5"	AQU3426RCXAXB4	64.5"	4
		600	18	AEU3182RCXAXT1B4	37.5"	AEU3182RCXAXB4	31.5"
	400	30	AEU3302RCXAXT1B4	43.5"	AEU3302RCXAXB4	37.5"	3
		42	AEU3422RCXAXT1B4	49.5"	AEU3422RCXAXB4	43.5"	4
		42	AEU3184RCXAXT1B4	64.5"	-	-	2
480/277 Vac, 3 Phase	100-225	18	AEU3424RCXAXT1B4	76.5"	AEU3424RCXAXB4	64.5"	4
		42	AEU3186RCXAXT1B4	64.5"	-	-	2
		600	18	AEU3426RCXAXT1B4	76.5"	AEU3426RCXAXB4	64.5"

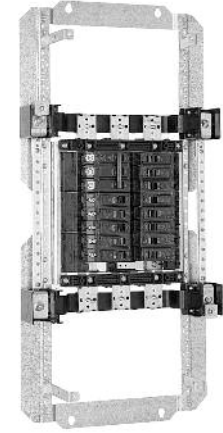

#### Aluminum Bus

Voltage	Rating (Amps)	No. of Circuits	Feed-thru Product Number <sup>1</sup>	Box/Front Height	TGL2 Ground Bars <sup>2,3</sup>
240 Vac, 1 Phase	100-225	18	AQU1182RCXAXT1	37.5"	2
		30	AQU1302RCXAXT1	43.5"	3
		42	AQU1422RCXAXT1	49.5"	4
208/120 Vac, 3 Phase	100-225	18	AQU3182RCXAXT1	37.5"	2
		30	AQU3302RCXAXT1	43.5"	3
		42	AQU3422RCXAXT1	49.5"	4
480/277 Vac, 3 Phase	100-225	18	AEU3182RCXAXT1	37.5"	2
		30	AEU3302RCXAXT1	43.5"	3
		42	AEU3422RCXAXT1	49.5"	4

#### TGL20 Ground Lug Quantities

Interior Type	No. of TGL20s Required by Panel Rating		
	100A-225A	400A	600A
Main Lug Only	1	1	2
Main Lug and Feed-thru	2	2	4
Main Breaker Only	1	1	1
Main Breaker and Sub-feed	1	1	1
Main Breaker and Feed-thru	2	2	3

<sup>1</sup>For CSA label, add "M8" suffix to product number.

<sup>2</sup>For TGL20 ground lug quantities, see TGL20 Ground Lug Quantities table above.

<sup>3</sup>For isolated ground, use EGS12. When using the EGS12, 3, 5 and 7 ground lugs (TGL20s) are required for 18, 30 and 42 circuits respectively.



# Panelboards

## A-Series™ Panelboards

### Pro-Stock, Unassembled Lighting Panels

## Section 11

### 2 Select Box

Select a box of the correct height (see Step 1). Boxes come with blank endwalls. If endwalls with knockouts are required, also order knockout endwall kit AKEW2.

Box Height	NEMA 1		NEMA 3R/12
	20" Wide Product Number <sup>1</sup>	30" Wide Product Number <sup>1</sup>	20" Wide Product Number <sup>1</sup>
31.5"	AB31B	AB31BW	AB313
37.5"	AB37B	AB37BW	AB373
43.5"	AB43B	AB43BW	AB433
49.5"	AB49B	AB49BW	AB493
64.5"	AB64B	AB64BW	AB643
76.5"	AB76B	AB76BW	AB763

<sup>1</sup>For CSA label, add "A" suffix to product number.



NEMA 1



NEMA 3R/12

### 3 Select Front

Select a front of the correct height (see Step 1).

Front Height	Standard (20" wide)		Door Within Door (20" wide)		Front Hinged To Box (20" wide)		Standard (30" Wide)	
	Flush <sup>1</sup>	Surface <sup>1</sup>	Flush <sup>1</sup>	Surface <sup>1</sup>	Flush <sup>1</sup>	Surface <sup>1</sup>	Flush <sup>1</sup>	Surface <sup>1</sup>
31.5"	AF31F	AF31S	AF31FP	AF31SP	AF31FD	AF31SD	AF31FW	AF31SW
37.5"	AF37F	AF37S	AF37FP	AF37SP	AF37FD	AF37SD	AF37FW	AF37SW
43.5"	AF43F	AF43S	AF43FP	AF43SP	AF43FD	AF43SD	AF43FW	AF43SW
49.5"	AF49F	AF49S	AF49FP	AF49SP	AF49FD	AF49SD	AF49FW	AF49SW
64.5"	AF64F	AF64S	AF64FP	AF64SP	AF64FD	AF64SD	AF64FW	AF64SW
76.5"	AF76F	AF76S	AF76FP	AF76SP	AF76FD	AF76SD	AF76FW	AF76SW

<sup>1</sup>For CSA label, add "A" suffix to product number.



Door Within Door



Standard



Front Hinged to Box



# Panelboards

## A-Series™ Panelboards

### Pro-Stock, Unassembled Lighting Panels

#### 4 Select Main and/or Sub-feed Breaker Kit

Select main breaker kit appropriate for your interior type (see Step 1), amp rating and kAIC rating. If a sub-feed breaker is required, repeat the selection process.

**Note: 400A and 600A breaker kits cannot be used for sub-feed applications in Pro-Stock panelboards.**

For additional details, see Section 6 of the BuyLog.

Interior Type	Product Number <sup>1</sup>	Rating Amps	No. of Poles	Breaker Rating (kAIC)						
				10	14	22	25	65	100	200
AQU1: 240 VAC 1 Phase	MB612	100	2	THQB		THHQB				
	MB614	100	4	(2) THQB		(2) THHQB				
	MB512	225	2	TQD		THQD				
	MB332	400	2					SGHA	SGLA	SGPA
	MB332	600	2					SGHA	SGLA	SGPA
	MB332WB	600	2					SGHA+Kit		
AQU3: 208/120 VAC, 3 Phase	MB613	100	3	THQB		THHQB				
	MB616	100	6	(2) THQB		(2) THHQB				
	MB513	225	3	TQD		THQD				
	MB516	400	6	(2) TQD		(2) THQD				
	MB233	225	3					SFHA	SFLA	SFPA
	MB233WB	225	3					SFHA+Kit		
	MB2332 <sup>5</sup>	400	6 <sup>5</sup>					2nd SFHA		
	MB2332WB <sup>5</sup>	400	6 <sup>5</sup>					2nd SFHA+Kit		
	MB333	400	3					SGHA	SGLA	SGPA
	MB333	600	3					SGHA	SGLA	SGPA
AEU3: 480/277 Vac, 3 Phase	MB333WB	600	3					SGHA+Kit		
	MB423	100	3		TEY					
	MB426	100	6		(2) TEY					
	MB133	150	3		TED <sup>2</sup>		THED			
	MB133	150	3				SEHA	SELA	SEPA	
	MB133WB	150	3				SEHA+Kit			
	MB233	225	3				SFHA <sup>4</sup>	SFLA	SFPA	
	MB233WB	225	3				SFHA+Kit <sup>4</sup>			
	MB2332 <sup>5</sup>	400	6 <sup>5</sup>				2nd SFHA <sup>4</sup>			
	MB2332WB <sup>5</sup>	400	6 <sup>5</sup>				2nd SFHA+Kit <sup>4</sup>			
	MB333	400	3				SGHA <sup>4</sup>	SGLA	SGPA	
	MB333	600	3				SGHA <sup>4</sup>	SGLA	SGPA	
MB333WB	600	3				SGHA+Kit <sup>4</sup>				

<sup>1</sup>Breaker not included except for "WB" kits (where product number ends in "WB"). "WB" kits include a breaker, mounting kit and load-side lugs. Rating plugs must be ordered separately.

<sup>2</sup>Actual breaker rating is 18kAIC.

<sup>3</sup>Actual breaker rating is 30kAIC.

<sup>4</sup>Actual breaker rating is 35kAIC.

<sup>5</sup>To achieve 6 poles of subfeed, the MB233WB or MB233 kit is also required. 6 poles of subfeed only work with 400A and 600A interiors.

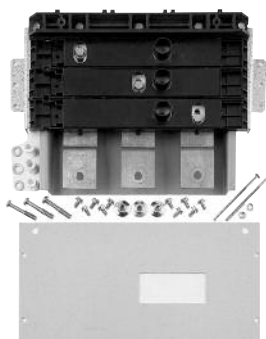

MB513 Breaker Kit

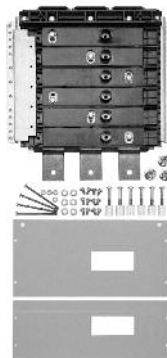

MB516 6-Pole Breaker Kit

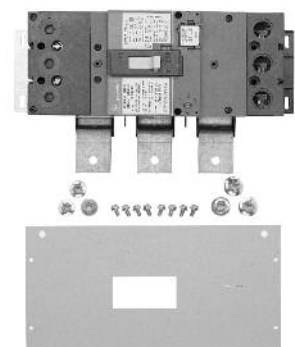

MB233WB "WB" Breaker Kit



# Panelboards

## A-Series™ Panelboards

### Pro-Stock, Unassembled Lighting Panels

#### 5 Typical Main Breakers

- Skip Step 5 if you selected a main breaker kit ending in “WB” — no breaker is required.
- To correlate breaker types with the kAIC rating in specific panelboards, see the table for Step 4. For more rating details, see A-Series™ Lighting Panels Rating Series Labels (DEH-40007).
- All TQD and Spectra™ main breakers require line-side lugs.
- For TEY and THQB main breakers, see branch breakers tables in Step 7.

#### Digital, Solid State Spectra™ RMS Breakers (3-pole) For use with appropriate main breaker kit (see Step 4).

Poles	Breaker		Rating Plug <sup>1</sup>		Terminal Lugs for Front Connection <sup>2</sup>						
	Current Sensor	Product Number	Amp Rating	Product Number	Product Number	Wire Range (Cu/Al)					
3	100	SEDA36AT0100	100	SRPE100A100	TCAL18	#12-3/0					
		SEHA36AT0100									
		SELA36AT0100									
		SEPA36AT0100									
	150	SEDA36AT0150	110	SRPE150A110							
		SELA36AT0150	125	SRPE150A125							
3	250	SFLA36AT0250 SFPA36AT0250	70	SRPF250A70	TCAL29	#8-350 MCM					
			90	SRPF250A90							
			100	SRPF250A100							
			110	SRPF250A110							
			125	SRPF250A125							
			150	SRPF250A150							
			175	SRPF250A175							
			200	SRPF250A200							
			225	SRPF250A225							
			3	400			SGHA36AT0400 SGLA36AT0400 SGPA36AT0400	125	SRPG400A125	TCLK365	Al: (2) 2/0-500 MCM or (1) #6-600 MCM Cu: (2) 2/0-400 MCM or (1) #8-600 MCM
								150	SRPG400A150		
								175	SRPG400A175		
								200	SRPG400A200		
								225	SRPG400A225		
250	SRPG400A250										
2	400	SGHA26AT0400 SGLA26AT0400 SGPA26AT0400	300	SRPG400A300	TCLK265						
			350	SRPG400A350							
			400	SRPG400A400							
			250	SRPG600A250							
3	600	SGLA36AT0600 SGPA36AT0600	300	SRPG600A300	TCLK365						
			350	SRPG600A350							
			400	SRPG600A400							
2	600	SGLA26AT0600 SGPA26AT0600	500	SRPG600A500	TCLK265						
			600	SRPG600A600							
			600	SRPG600A600							

<sup>1</sup>Any rating plug within a given current sensor group may be paired with any breaker in that group.

<sup>2</sup>Except for “WB” kits, lugs must be ordered separately for Spectra™ breakers. All Spectra™ breakers also require an appropriate rating plug.

#### Main or subfeed breakers for use with AQ panels (208/120 Vac 3-phase or 240 Vac single phase). See Step 4.

Amp Rating	2-pole				3-pole			
	10kAIC		22kAIC		10kAIC		22kAIC	
	Product <sup>3</sup> Number		Product Number		Product <sup>3</sup> Number		Product Number	
100	TQD22100X2		THQD22100X2		TQD32100X2		THQD32100X2	
125	TQD22125X2		THQD22125X2		TQD32125X2		THQD32125X2	
150	TQD22150X2		THQD22150X2		TQD32150X2		THQD32150X2	
175	TQD22175X2		THQD22175X2		TQD32175X2		THQD32175X2	
200	TQD22200X2		THQD22200X2		TQD32200X2		THQD32200X2	
225	TQD22225X2		THQD22225X2		TQD32225X2		THQD32225X2	
250	-		TJD422250L2		-		TJD432250L3	
300	-		TJD422300L2		-		TJD432300L3	
350	-		TJD422350L2		-		TJD432350L3	
400	-		TJD422400L2		-		TJD432400L3	

#### Main or subfeed breakers for use with AE panels (480/277 Vac 3-phase). See Step 4.

Amp Rating	3-pole		
	18kAIC	22kAIC	30kAIC
	Product Number		
100	TED134110WL	THED134110WL	MB233WB
125	TED134125WL	THED134125WL	MB233WB
150	TED134150WL	THED134150WL	MB233WB
175	-	-	MB233WB
200	-	-	MB233WB
225	-	-	MB233WB
250	-	-	TJJ436250L3
300	-	-	TJJ436300L3
350	-	-	TJJ436350L3
400	-	-	TJJ436400L3

<sup>3</sup>Any load-side lugs on TQD breakers must be removed before assembly. TQD breakers with X2 product number suffix feature line-side lugs only.





# Panelboards

## A-Series™ Panelboards

### Pro-Stock, Unassembled Lighting Panels

#### 6 Select Main Lug Kit and Accessories

Select lug kit(s) for main lug and/or feed-thru applications, if required. (All lugs are suitable for interiors with either copper or aluminum bus.) Also select any accessories required.



#### Main Lug Kits

Lug Type	Amp Rating	Standard		Oversized		200% Neutral
		Product Number	Wire Range	Product Number	Wire Range	Product Number
Pressure	225	MLA1	6-350 MCM	MLA2	1-600 MCM or (2) 1/0-250 MCM	NKA
	400	MLA41	2-600 MCM or (2) 1/0-250 MCM	MLA62	3/0-800 MCM	NKA4 <sup>2</sup>
	600	MLA61	(2) 2/0-500 MCM	MLA62	3/0-800 MCM	-
Copper	225	MLR1	4-350 MCM	MLR2	1-600 MCM	NKR
	400	MLR41	1-600 MCM	MLR61	(2) 2/0-500 MCM	NKR4
	600	MLR61	(2) 2/0-500 MCM	-	-	-
Compression	225	MLT1	2/0-300 MCM	MLT2	4/0-500 MCM	NKT
	400	MLT42	250-600 MCM	MLT41	500-750 MCM <sup>1</sup>	NKT4
Dual	225	MLA2	1-600 MCM or (2) 1/0-250 MCM	-	-	-
Main	400	MLA61	(2) 2/0-500 MCM	-	-	-

<sup>1</sup>500 MCM Cu, 750 MCM Al.

<sup>2</sup>For 200% neutral feed-thru, order NKA4FT, (GO-101P). Wire range (2) 2/0 - 600 MCM or (4) 4-250 MCM.

#### Accessories

Service Entrance <sup>3</sup>	
Amp Rating	Product Number
225A	BNDKT
400A	BNDKT6
600A	BNDKT6

<sup>3</sup>Service entrance kit includes a bonding strap with hardware and a service entrance label.

ProCare Kit <sup>4</sup>	
Description	Product Number
ProCare Kit for Pro-Stock panelboard installation and maintenance	PROCARE

<sup>4</sup>ProCare Kit includes: (5) filler plate hardware kits, (9) bus stud nuts, (5) MLA1 filler plates, (2) 225A phase barriers, (2) feed-thru barriers, (1) 400/600A phase barrier, (50) directory cards/rating books, (50) circuit number strips (1-48), (50) circuit number strips (43-84), (5) standard locks and keys, (50) deadfront screws, (10) AQ/AE front hardware kits, (10) AD front hardware kits, (50) service disconnect labels, (50) main labels.

#### 7 Typical Bolt-On Branch Breakers

These tables show typical branch breakers, but do not include all branch breakers that can be used with Pro-Stock panelboards.

#### Branch circuit breakers for use with AQ panels (208/120 Vac 3-phase or 240 Vac single phase)

Amp Rating	10kAIC			22kAIC		
	1-pole Product Number	2-pole Product Number	3-pole Product Number	1-pole Product Number	2-pole Product Number	3-pole Product Number
15	THQB1115	THQB2115	THQB32015	THQB1115	THQB2115	THQB32015
20	THQB1120	THQB2120	THQB32020	THQB1120	THQB2120	THQB32020
25	THQB1125	THQB2125	THQB32025	THQB1125	THQB2125	THQB32025
30	THQB1130	THQB2130	THQB32030	THQB1130	THQB2130	THQB32030
35	THQB1135	THQB2135	THQB32035	THQB1135	THQB2135	THQB32035
40	THQB1140	THQB2140	THQB32040	THQB1140	THQB2140	THQB32040
45	THQB1145	THQB2145	THQB32045	THQB1145	THQB2145	THQB32045
50	THQB1150	THQB2150	THQB32050	THQB1150	THQB2150	THQB32050
60	THQB1160	THQB2160	THQB32060	THQB1160	THQB2160	THQB32060
70	THQB1170	THQB2170	THQB32070	THQB1170	THQB2170	THQB32070
80	-	THQB2180	THQB32080	-	THQB2180	THQB32080
90	-	THQB2190	THQB32090	-	THQB2190	THQB32090
100	-	THQB21100	THQB32100	-	THQB21100	THQB32100

#### Branch circuit breakers for use with AE panels (480/277 Vac 3-phase)

Amp Rating	14kAIC		
	1-pole Product Number	2-pole Product Number	3-pole Product Number
15	TEY115	TEY215	TEY315
20	TEY120	TEY220	TEY320
30	TEY130	TEY230	TEY330
40	TEY140	TEY240	TEY340
50	TEY150	TEY250	TEY350
60	TEY160	TEY260	TEY360
70	TEY170	TEY270	TEY370
80	TEY180	TEY280	TEY380
90	TEY190	TEY290	TEY390
100	TEY1100	TEY2100	TEY3100

# Panelboards

## A-Series™ Panelboards

### Pro-Stock, Unassembled Lighting Panels

## Section 11

#### Pro-Stock Interiors Product Number Structure

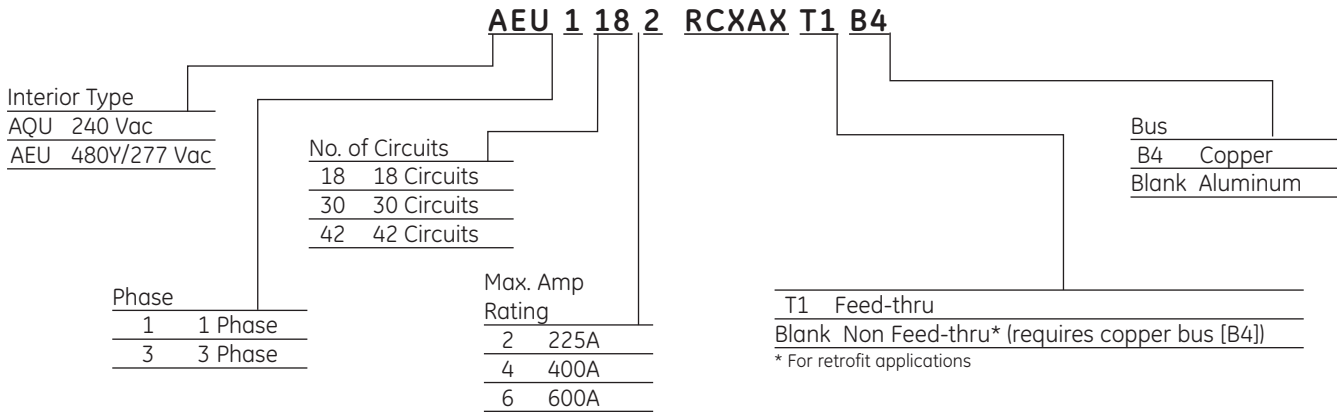

# Panelboards

## A-Series™ Panelboards

### Product Options

#### Enclosure Options

**BOX EXTENSIONS**—For additional end gutter space or conduit skirt applications—see page 11-20.

#### Equipment Grounds—Factory Supplied with Panelboard

Description	Product Number
Field installed kits	
Standard bonded to box—for each 12 branch positions	TGL2
Copper bonded to box—for each 12 branch positions	TGC2
Standard-isolated/insulated—for each 12 branch positions	EGS12
Copper-isolated/insulated—for each 12 branch positions	EGC12
Main lug for above terminal kits	TGL20

#### Optional Equipment Grounds

Description	Product Number
Aluminum Extruded Bonded	AEBG
Copper Extruded Bonded	AEBGC
Aluminum Extruded Isolated	AEIG
Copper Extruded Isolated	AEIGC
Copper Isolated/Bonded	ASPGIBC

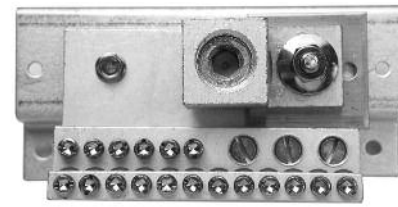

AEBG

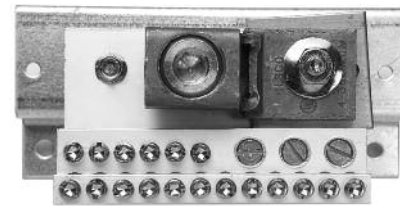

AEBGC

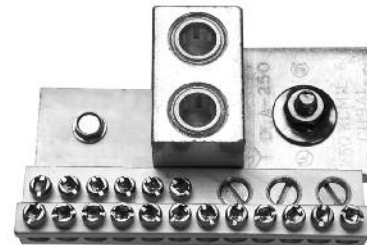

AEIG

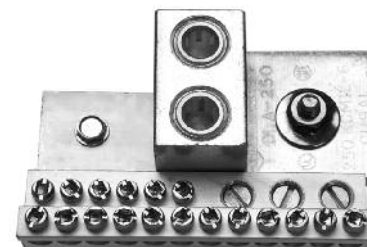

AEIGC



ASPGIBC



# Panelboards

## A-Series™ Panelboards

### Accessories

### Field Installed Kits/Replacement Parts

### Order By Product Number from Factory

#### Endwall Kits

Field installed. For standard 20"w x 5.81"d boxes.

Product Number	Description	Qty.
ABEW2	Blank	1
AKEW2	Knockout	1

#### Panelboards Parts

Description	Product Number
Directory Card	139C5612P3
Replacement Lock with Std. Key	569B737P1
Replacement Lock with GE75 Key	569B737P2
Additional Keys for Above Lock	569B737P5
Circuit Numbering Strips-	
1-48	569B806G1
49-84	569B806G2
85-126	569B806G3
Adhesive Backed Lamicoïd Nameplate 3/4 in. x 3 in.	315A7190P1
Metal Directory Card Holder	139C5491G1
Directory Card Holder	139C5491P4
Delta Hi-leg Conversion Kit, to Add B-Phase	
Plug on AL Panels	APHBL
Bolt on AE/AQ Panels	APHBQ
NEMA 3R/12 Tamper Proof Torq Screw Kit	NEMATRX
2P to 3P TQD Conv. Kit	ASP2PTQD3P
2P to 3P SF Conv. Kit for horizontal subfeed	ASP2PTEJ3P
AD 25 to 65 kAIC Barrier kit	ASP25AD65KA
Service Entrance Kit	ASPSERENT
2 wire Relay Kit	ASP2WRelay
Yale Lock Kit	ASPYALE47
Corbin Lock Kit	ASPCORBNTUJ1
2-3 pole TQD Mechanical Interlock	TQDFM1
AQ/AL/AE Rail Bracket	ASPAQLEBKT
Front Flush Adjust Kit	ASPFLUSHADJ
AE Front Mounting Kit	139C5720G3
AQ/AL Front Mounting Kit	139C5720G6
AD Front Mounting Kit	139C5720G9
Front Hinge to Box Mounting Kit	139C5700G6
Front Extension Mounting Kit	139C5700G11

<sup>1</sup>Included in factory assembled panels—AD panels with Spectra™ branch breakers.

#### Permanent Circuit Number Kits

Product Number		Description
AQ, AL, AE	AD	
APN48	APN48AD	No's 1-48
APN84	APN84AD	No's 43-84
APN126	APN126AD	No's 85-126



Replacement Lock with Standard Key

Replacement Lock with GE75 Key

#### Box Extensions

Bolts to A-SERIES™ box with or without box endwall in place. Extensions can be combined to obtain lengths greater than 18 and 24 inches.

Box Width and Depth	Box Mounting	Box Extension Length (Inches)	Box Extension Product Number
20 x 5.81	Flush	9	ABX2509F
		18	ABX2518F
		24	ABX2524F
		9	ABX2509S
		18	ABX2518S
		24	ABX2524S
	Surface	31	ABX2531S
		37	ABX2537S
		43	ABX2543S
		49	ABX2549S
		55	ABX2555S
		64	ABX2564S
30 x 5.81	Flush	76	ABX2576S
		18	ABX3518F
		24	ABX3524F
	Surface	18	ABX3518S
		24	ABX3524S
		24	ABX3524S
30 x 7.81	Flush	18	ABX3718F
		24	ABX3724F
	Surface	18	ABX3718S
		24	ABX3724S

#### Box Extensions Covers Only

10 covers per kit.

Description	Product Number
9" Covers Surface	ASPABX09S
9" Covers Flush	ASPABX09F
18" Covers Surface	ASPABX18S
18" Covers Flush	ASPABX18F
64" to 76" Covers Surface	ASPABX20S
64" to 76" Covers Flush	ASPABX20F



# Panelboards

## A-Series™ Power Panelboards

### Features

- Symmetrical design, no required top or bottom mountings
- Single-piece deadfront – no filler plates needed
- Smaller, lighter panel than Spectra Series panelboards
- Easy-to-install galvanized enclosures with removable endwalls
- Ready-to-install hinged trim options
- Branch-bus direct connection
- Up to 600A breaker mounted as a branch device
- Deeper (8"), wider (30") A-Series box to accommodate larger wire sizes
- Double branched 150A (ED/SE) and 225A (QD) breakers
- Vertically mounted main circuit breakers in 800A
- Captive hardware on branch breakers
- Staggered, center-mounted, larger frame breakers (SG, SF) for easy installation
- Bus-connected TVSS for maximum surge protection
- Narrow design to minimize footprint
- Enclosure available in NEMA Type 1, Type 3R/12, Type 4/4X

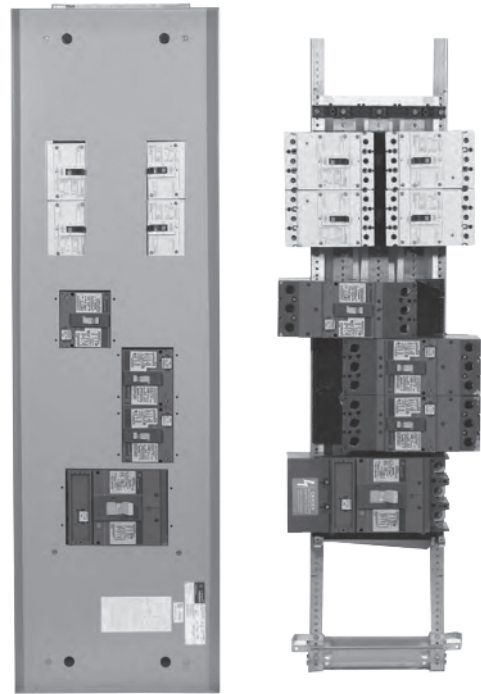

### Type AQP

---

**Service Information:**

1P, 3W-240/120 Vac  
3P, 3W-240 Vac  
3P, 4W-208/120 Vac  
Fully Rated-65kAIC at 240 Vac  
Series Rated-200kAIC at 240 Vac

**Mains****Breakers:**

125-800A: SG, SK

**MainLug:**

600-800A

**Branch Breakers (Bolt-on):**

15A-100A (1P, 2P, 3P): QB  
Double Branch- TQD, SE  
Center-Mounted- SF, SG

**Enclosures**

Length-25.5, 31.5, 37.5, 43.5, 49.5, 55.5, 64.5, 76.5, 82.5, 88.5  
Width-30"  
Depth-8"

### Type AEP

---

**Service Information:**

1P, 3W-240/120 Vac  
3P, 3W-240 Vac  
3P, 4W-208/120 Vac, 480/277 Vac  
Fully Rated- 18kAIC at 480/277 Vac, 65kAIC at 240Vac  
Series Rated- 100kAIC at 480 Vac, 200kAIC at 240 Vac

**Mains****Breakers:**

125-800A: SG, SK

**MainLug:**

600-800A

**Branch Breakers (Bolt-on):**

15A-100A (1P, 2P, 3P): TEY, TEYF  
Double Branch- TED, SE  
Center-Mounted-SF, SG

**Enclosures**

Length-25.5, 31.5, 37.5, 43.5, 49.5, 55.5, 64.5, 76.5, 82.5, 88.5  
Width-30"  
Depth-8"

### Type ADP

---

**Service Information:**

1P, 3W-240/120 Vac  
3P, 3W-240 Vac  
3P, 4W-208/120 Vac, 480/277 Vac  
Fully Rated-100kAIC at 480 Vac  
Series Rated-100kAIC at 480 Vac

**Mains****Breakers:**

125-800A: SG, SK

**MainLug:**

600-800A

**Branch Breakers (Bolt-on):**

15A-100A (1P, 2P, 3P): FB Breakers  
15A-100A (1P, 2P, 3P): THED Breakers  
15A-150A (3P): THED Breakers  
Double Branch-TED, SE  
Center-Mounted-SF, SG

**Enclosures**

Length-25.5, 31.5, 37.5, 43.5, 49.5, 55.5, 64.5, 76.5, 82.5, 88.5  
Width-30"  
Depth-8"



# Panelboards

## A-Series™ Panelboards

### Branch Circuit Monitoring

This panelboard provides branch circuit reporting capabilities in a Type AQ or AE panelboard. It delivers valuable branch usage data, similar to the Spectra Integrated Submetering Panelboard, but in the A-Series platform. Via a building automation system, users can tap this data to analyze usage and identify potential cost-savings measures, create load based cost allocation billing, and head off potential problems before they occur.

#### Features

---

- Accuracy: Revenue Class,  $\pm 0.5\%$ ; IEC 62053-21 Class 1, ANSI C12.1-2008
- Ability to report volts, amps, power, and energy for each circuit
- Monitors 42 circuits (and mains as an option) with one product
- 4 user-configurable alarm threshold registers improve load management
- Built-in ability to set the orientation and numbering of the circuits
- 1/4 amp to 100 amp monitoring – the widest dynamic range in the industry
- 1, 2, 3 pole breaker support
- 5 year warranty
- Modbus RTU via RS485 communications

#### References

---

DEA-539 for additional information  
Speedi for configuration/quotation purposes

---

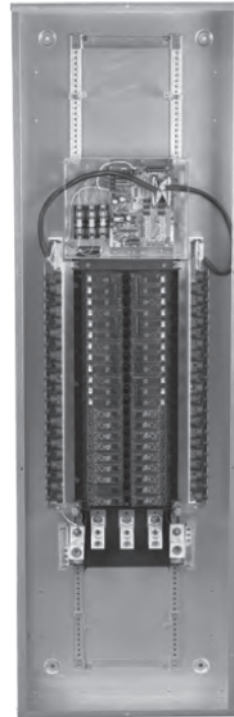

# Panelboards

## Spectra™ Series Panelboards

## Section 11

### MCCB and Fusible Mains and Feeders

#### Service Information:

600 Vac maximum  
250 Vdc maximum  
1ph-3w, 3ph-3w/4w

#### Mains:

1200 A maximum main lugs, circuit breaker, or fusible switch

#### Branches:

15-1200 Circuit  
Breakers  
30-1200 (2P, 3P) Fusible Switch

#### Fuse:

Not Included

#### Fuse Provisions:

30-600 Amp Units: Class R<sup>1</sup>  
800-1200 amp units: Class L<sup>2</sup>

### Features

---

- Main bus, 250-1200 amp, copper or aluminum
- Wide, easy-to-install galvanized enclosures with removable endwalls
- 5 box widths simplify installation and design
- Enclosures available in NEMA Type 1, Type 3R/12, Type 4/4X
- Integrated TVSS for maximum surge protection
- Optional door-in-door or front-hinged-to-box construction
- Reduced density copper or aluminum bus
- 200% rated neutrals available
- Vertically mounted main circuit breakers available
- Branch-bus direct connection
- Captive hardware on branch breakers
- Front accessible main lug assembly
- Process control unit in plug-in style
- Spectra MVT breaker option for main/branch breakers
- 100% rated breakers available
- Individual breaker cover plates

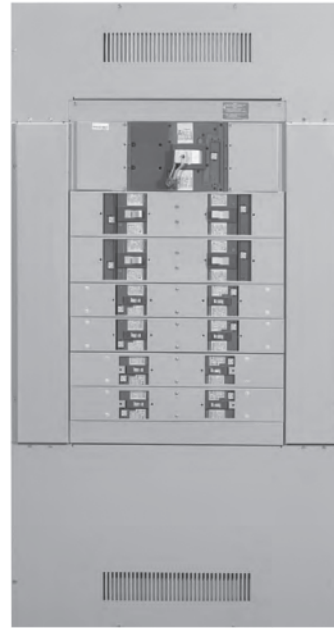

### Bolt On

---

#### Service Information:

1P, 3W-600/347 Vac  
3P, 4W-600/347 Vac

Fully Rated- 200KAIC at 480/277 Vac  
Series Rated- 200KAIC at 480/277 Vac

#### Mains

#### Breakers:

250A-1200A: SF, SG, SK, FG

#### Branch Breakers (Bolt-on):

Double Branch-SE, SF, SG, FG, FB, TEY, TEB, TQD Breakers  
Center-mounted-SK Breakers

### Plug In

---

#### Service Information:

1P, 3W-600/347 Vac  
3P, 4W-600/347 Vac

Fully Rated-200KAIC at 480/277 Vac  
Series Rated-200KAIC at 480/277 Vac

#### Mains

#### Breakers:

250A-1200A: SF, SG, SK, FG

#### Branch Breakers/Switches (Plug In):

Double Branch-SE, SF, SG, FG, FB, TEY, TEB, TQD Breakers  
Center-mounted- SK Breakers  
30A-1200A Fused Switches (R, J, H, K, T Fuses)





# Panelboards Spectra™ Series Panelboards Fusible Switches Load and Interrupting Ratings

### Short Circuit Ratings—Fusible Switch Units (Plug-In Only)

UL Class	Available Amp Rating	Maximum Short-Circuit Rating in Sym. rms Amps	Max. Voltage	Application
H	30-600	10,000	250/600	One-time general purpose
J	30-600	200,000	600	Fast-acting rejection sizing mains & feeders, current limiting
K	30-600	50,000	250/600	Dual element no rejection means, motor starting current limiting
		100,000		
		200,000		
L	800-1200	200,000	600	Rejection means available in two forms
				Fast-acting mains & feeders
R	30-600	100,000	250/600	Time-delay motor starting current limiting
		200,000		
T	100-600	200,000	250/600	Fast-acting small physical size mains & feeders, current limiting

### Panelboard Terminal Lugs - Main Lugs<sup>2</sup> and Neutral Incoming Lugs

#### Lighting Panels (A-Series™)

Panelboard Types	Max. Main Bus Rating in Amps	No. Per	Terminal Lugs (Cu-Al)	
			No. Per Lug	Range
AL AQ AE AD	125	1	1	#14-2/0
	225	1	1	#6-350kcmil
	400	1	1	#4-600kcmil or
			2	1/0-250kcmil
	600	1	2	2/0-500 mcm
	800	2	2	3/0-500 mcm

<sup>2</sup>Additional lug sizes available using oversize items.

#### 200% Neutral Lugs

125A - (2) - #14-2/0  
225A - (2) - #6-250 MCM  
400A - (2) - #4-600 MCM  
600A - (4) - #4-600 MCM

#### Branch Neutral Lugs

Small Holes #14-#4  
Large Holes #14-2/0

#### Column Type Panels

Panelboard Types	Max. Main Bus Rating in Amps	No. Per	Terminal Lugs (Cu-Al)	
			No. Per Lug	Range
ALC AQC AEC	100	1	1	#6-2/0
	225	1	1	#6-350kcmil

### Maximum Horsepower Ratings<sup>1</sup> ADS Fusible Switch

Rating in Amps <sup>1</sup>	Volts, ac						Volts, dc		
	2-Pole			3-Pole			2-Pole	2-Pole	
	120	240	480	600	240	480	600	125	250
With Standard Fuses									
30	1/2	1 1/2	3	3	3	5	7 1/2	2	5
60	1 1/2	3	5	10	7 1/2	15	15	5	10
100	—	7 1/2	10	15	15	25	30	—	20
200	—	15	25	30	25	50	60	—	40
400	—	—	—	—	50	100	125	—	50
600	—	—	—	—	75	150	200	—	50
With "Time-delay" Fuses									
30	2	3	7 1/2	10	7 1/2	15	20	3	—
60	3	10	20	25	15	30	50	—	—
100	—	15	30	40	30	60	75	—	—
200	—	15	50	50	60	125	150	—	—
400	—	—	—	—	125	250	350	—	—
600	—	—	—	—	200	400	500	—	—

<sup>1</sup>Ratings are based on latest revision of the National Electrical Code Article 430. Horsepower ratings for switches with Standard Class H fuses are based on one-time fuses having minimum time-delay. When time-delay fuses are used, the horsepower ratings are maximum for the switches.

### Spectra™ Optional Main Lug Terminations

	# Wires Per Lug	Max. # Lugs Per Phase		
		250-600A	800A 1200A 21"	800A 1200A 27"
CU/AL Mechanical				
#6-350 kcmil	1	2	2	4
#2-500 kcmil	2	2	2	4
#2-600 kcmil	2	2	2	4
3/0 750 kcmil	2	2	2	4
CU/AL Compression <sup>3</sup>				
1/0	1	4	4	8
2/0	1	4	4	8
3/0	1	4	4	8
4/0	1	4	4	8
250 kcmil	1	4	4	8
300 kcmil	1	4	4	8
350 kcmil	1	4	4	8
400 kcmil	1	4	4	8
500 kcmil	1	4	4	8
600 kcmil	1	4	4	8
750 kcmil	1	4	4	8

<sup>3</sup>Not available on 19" main lug module.



# Panelboards Spectra™ Series Panelboards Fusible Switches Load and Interrupting Ratings

### Spectra™ Series Neutral Kits

- Includes mechanical lugs and bonding strap.
- 250 to 600A neutral kits can be converted to dual main version by doubling the main lug quantity using lug kits (see Accessories).
- Main lug on neutral kit can be converted to compression main using AMKP lug kit.

Amps	Standard Neutral (Single Main Lug) <sup>4</sup>			Dual Main Neutral <sup>5</sup>		
	Product Number	Accepts Wire Qty.	Accepts Wire Size (Cu/Al)	Product Number	Accepts Wire Qty.	Accepts Wire Size (Cu/Al)
250	ANKN400	2 (Main)	#2 - 600kcmil	ANKN400	2 (Main)	#2 - 600kcmil
		16	#14 - 2/0		16	#14 - 2/0
		5	#6 - 300kcmil		5	#6 - 300kcmil
		24	#14 - #4		24	#14 - #4
400	ANKN400	2 (Main)	#2 - 600kcmil	ANKN120	8 (Main)	#2 - 600kcmil
		16	#14 - 2/0		9	#14 - 2/0
		5	#6 - 300kcmil		10	#6 - 300kcmil
		24	#14 - #4		10	#14 - #4
600	ANKN120	8 (Main)	#2 - 600kcmil	ANKN120	8 (Main)	#2 - 600kcmil
		9	#14 - 2/0		9	#14 - 2/0
		10	#6 - 300kcmil		10	#6 - 300kcmil
		10	#14 - #4		10	#14 - #4
800	ANKN120	8 (Main)	#2 - 600kcmil	ANK800D	8 (Main)	#2 - 500kcmil
		9	#14 - 2/0		8	#14 - 2/0
		10	#6 - 300kcmil		10	#6 - 300kcmil
		10	#14 - #4		4	#2 - 500kcmil
1200	ANKN120	8 (Main)	#2 - 600kcmil	ANK120D	8 (Main)	#2 - 500kcmil
		9	#14 - 2/0		8	#14 - 2/0
		10	#6 - 300kcmil		10	#6 - 300kcmil
		10	#14 - #4		4	#2 - 500kcmil

<sup>4</sup>For 3ph, 4W single-section panelboards, use a standard neutral.

<sup>5</sup>For 3ph, 4W multi-section panelboards, use a standard neutral on the last section, and a dual main neutral on the first and middle sections.

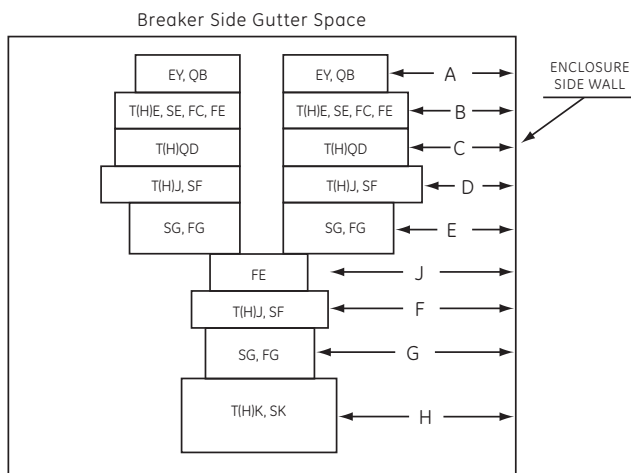

**ALL DIMENSIONS ARE FROM FACE OF LUG, SHOWN IN INCHES AND ± .250 Single mounted devices as branch or main**

Breakers are arranged, as a standard and if not specified, with largest and highest amperage closest to main incoming and the

smallest, lowest amperage furthest from the main incoming. The spaces, if any, will follow after the breakers. All main breakers are mounted horizontally and incoming lugs are, as a standard and if not specified, always oriented to the left gutter regardless if top or bottom feed. If 2 or more large branch breakers (SK, SG single mounted) are supplied with the board then the factory will start the first breaker with the lugs to the right and the second breaker with lugs to left and will continue staggering them until all have been installed. If any further clarification is needed, please contact your local GE representative.

Letter Reference	Enclosure Width				
	27	31	36	40	44
A	7.88	9.88	12.38	14.38	16.38
B	5.75	7.75	10.25	12.25	14.25
C	5.63	7.63	10.13	12.13	14.13
D	N/A	5.50	8	10	12
E	N/A	N/A	6.38	8.38	10.38
F	8.88	10.88	13.38	15.38	17.38
G	8.13	10.13	12.63	14.63	16.63
H	N/A	N/A	N/A	12.63	14.63
J	Breaker not available at time of printing				



# Panelboards Spectra™ Series Panelboards Merchandisable Kits and Sizing Information

### Spectra™ Series Type ANKN/ANK/ANKT Neutral Kits

Amps (N = Neutral, GF = Ground Fault)	Box Width	Main	Lug Type	Ground Fault	Product Number
250A Single & Dual	27-36"	Single/Dual	Mechanical	No	ANKN400 <sup>1</sup>
	27-36"	Single	Mechanical	No	ANK250 <sup>2</sup>
	27-36"	Dual	Mechanical	No	ANK250D <sup>2</sup>
	36"	Single	Crimp Main & Feeders	No	ANK250C
	36"	Dual	Crimp Main & Feeders	No	ANK250DC
250A 200%N	36"	Single/Dual	Mechanical	No	ANKN120 <sup>1</sup>
	36"	Single	Mechanical	No	ANKT36250 <sup>2</sup>
	36"	Dual	Mechanical	No	ANKT36250D <sup>2</sup>
400A Single & Dual	27-44"	Single	Mechanical	No	ANKN400 <sup>1</sup>
	27-44"	Single	Mechanical	No	ANK400 <sup>2</sup>
	27-44"	Single	Mechanical	No	ANKCU400 <sup>4</sup>
	27-44"	Dual	Mechanical	No	ANKN120 <sup>1</sup>
	27-44"	Dual	Mechanical	No	ANK400D <sup>2</sup>
	36-44"	Single	Crimp Main & Feeders	No	ANK400C
	36-44"	Dual	Crimp Main & Feeders	No	ANK400DC
400A GF	27-44"	Single	Mechanical	Yes	ANK400GF
	36-44"	Single	Crimp Main, Mech. Feeders	Yes	ANK400GFCM
400A 200%N	36-44"	Single/Dual	Mechanical	No	ANKN120 <sup>1</sup>
	36"	Single	Mechanical	No	ANKT36400 <sup>2</sup>
	40"	Single	Mechanical	No	ANKT40400 <sup>2</sup>
	44"	Single	Mechanical	No	ANKT44400 <sup>2</sup>
	36"	Dual	Mechanical	No	ANKT36400D <sup>2</sup>
	40"	Dual	Mechanical	No	ANKT40400D <sup>2</sup>
600A Single & Dual	27-44"	Single/Dual	Mechanical	No	ANKN120 <sup>1</sup>
	27-44"	Single	Mechanical	No	ANK600 <sup>2</sup>
	27-44"	Dual	Mechanical	No	ANK600D <sup>2</sup>
	36-44"	Single	Crimp Main & Feeders	No	ANK600C
	36-44"	Dual	Crimp Main & Feeders	No	ANK600DC
	27-44"	Single	Mechanical	Yes	ANK600GF
	36-44"	Single	Mechanical	No	ANKN120 <sup>1</sup>
600A 200%N	36"	Single	Mechanical	No	ANKT36600 <sup>2</sup>
	40"	Single	Mechanical	No	ANK40600 <sup>2</sup>
	44"	Single	Mechanical	No	ANK44600 <sup>2</sup>
	36"	Dual	Mechanical	No	ANKT36600D
	40"	Dual	Mechanical	No	ANKT40600D
	44"	Dual	Mechanical	No	ANKT44600D
800A Single & Dual	31-44"	Single	Mechanical	No	ANKN120 <sup>1</sup>
	31-44"	Single	Mechanical	No	ANK800 <sup>2</sup>
	31-44"	Dual	Mechanical	No	ANK800D <sup>3</sup>
	36-44"	Single	Crimp Main & Feeders	No	ANK800C
	36-44"	Dual	Crimp Main & Feeders	No	ANK800DC <sup>3</sup>
	31-44"	Single	Mechanical	Yes	ANK800GF <sup>3</sup>
800A GF	36-44"	Single	Crimp Main & Feeders	Yes	ANK800GFC <sup>3</sup>
	36"	Single	Mechanical	No	ANKT36800 <sup>3</sup>
800A 200%N	40"	Single	Mechanical	No	ANKT40800 <sup>3</sup>
	44"	Single	Mechanical	No	ANKT44800 <sup>3</sup>
	36"	Dual	Mechanical	No	ANKT36800D <sup>3</sup>
	40"	Dual	Mechanical	No	ANKT40800D <sup>3</sup>
1000A GF	44"	Dual	Mechanical	No	ANKT44800D <sup>3</sup>
	31-44"	Single	Mechanical	Yes	ANK100GF <sup>3</sup>
	36-44"	Single	Crimp Main & Feeders	Yes	ANK100GFC <sup>3</sup>
1200A Single & Dual	31-44"	Single	Mechanical	No	ANKN120 <sup>1</sup>
	31-44"	Single	Mechanical	No	ANKNCU120 <sup>4</sup>
	31-44"	Single	Mechanical	No	ANK120 <sup>2</sup>
	31-44"	Dual	Mechanical	No	ANK120D <sup>3</sup>
	31-44"	Dual	Mechanical	No	ANKNCU120D <sup>4</sup>
	36-44"	Single	Crimp Main & Feeders	No	ANK120C
	36-44"	Dual	Crimp Main & Feeders	No	ANK120DC <sup>3</sup>
1200A GF	31-44"	Single	Mechanical	Yes	ANK120GF <sup>3</sup>
	36-44"	Single	Crimp Main & Feeders	Yes	ANK120GFC <sup>3</sup>
1200A 200%N	36"	Single	Mechanical	No	ANKT36120 <sup>3</sup>
	40"	Single	Mechanical	No	ANKT40120 <sup>3</sup>
	44"	Single	Mechanical	No	ANKT44120 <sup>3</sup>
	36"	Dual	Mechanical	No	ANKT36120D <sup>3</sup>
	40"	Dual	Mechanical	No	ANKT40120D <sup>3</sup>
44"	Dual	Mechanical	No	ANKT44120D <sup>3</sup>	

<sup>1</sup>Wire range #2AWG through 600 kcmil.

<sup>2</sup>Wire range above 600 kcmil.

<sup>3</sup>These neutrals require the 29 inch "A" gutters in the 75" and 96" high enclosures (75 High-23X or 96 High-38X)

<sup>4</sup>Material = Copper main lugs, copper feeder.



Spectra™ Series Main Lugs Top or Bottom Feed 240 Vac and 600 Vac, 200-1200 Amperes

Main Lug Kits (Factory Installed and/or Merchandise Panelboards)

- Kit bolts directly to interior bus bars (either APN Plug-In Style or APNB Bolt-On Style).
- Can be used for feed-through lug application by replacing standard cover plate with AFL feed-through cover plate kit (See Accessories).
- F suffix indicates all AFPML cover plates are included to fit applicable box widths. If cover plates are not necessary, remove the F suffix.
- For 2 pole applications, replace the third digit or numeral “3” in the product number with the number “2”.
- Aluminum mechanical lugs can be converted to copper by replacing the first from last digit from an A to a C.

Standard Main Lug Kit (Mechanical Lugs)

Main Amps	Single or Dual Configuration	Module "X" Height	Product Number	Lugs Incl. Per Phase	Wires Per Lug	Wire Range (Cu/Al) <sup>1</sup>	Cover Plate Kit Included Product Number	Min. Box Width
250	Single & Dual	4X	AMB3600MAF	1	2	8-500kcmil(1) 2/0-600kcmil(1)	AFPML4X	27"
400	Single	4X	AMB3600MAF	1	2	8-500kcmil(1) 2/0-600kcmil(1)	AFPML4X	27"
	Dual	4X	AMB3120MAF	1	4	2/0-600kcmil(4)	AFPML4X	27"
600	Single	4X	AMB3600MAF	1	2	8-500kcmil(1) 2/0-600kcmil(1)	AFPML4X	27"
	Dual	4X	AMB3120MAF	1	4	2/0-600kcmil(4)	AFPML4X	27"
800	Single	4X	AMB3120MAF	1	4	2/0-600kcmil(4)	AFPML4X	31"
	Dual	4X	AMB3120DMAF	1	8	2/0-600kcmil(8)	AFPML4X	36"
1200	Single	4X	AMB3120MAF	1	4	2/0-600kcmil(4)	AFPML4X	31"
	Dual	4X	AMB3120DMAF	1	8	2/0-600kcmil(8)	AFPML4X	36"

<sup>1</sup>Copper lugs can only be used with copper wire

Compression Main Lug Kit

Main Amps	Single or Dual Configuration	Module "X" Height	Product Number	Lugs Incl. Per Phase	Wires Per Lug	Wire Range (Cu/Al)	Cover Plate Kit Included Product Number	Min. Box Width
250	Single	6X	AMB3250CAF	1	2	350 kcmil	AFPML6X	36"
	Dual	6X	AMB3250DCAF	2	1	350 kcmil	AFPML6X	36"
400	Single	6X	AMB3600CAF	2	1	500 kcmil	AFPML6X	36"
	Dual	6X	AMB3600DCAF	4	1	500 kcmil	AFPML6X	36"
600	Single	6X	AMB3600CAF	1	2	500 kcmil	AFPML6X	36"
	Dual	6X	AMB3600DCAF	4	1	500 kcmil	AFPML6X	36"
800	Single	6X	AMB3800CAF	3	1	500 kcmil	AFPML6X	36"
	Dual	6X	AMB3800DCAF	6	1	500 kcmil	AFPML6XW	36"
1200	Single	6X	AMB3120CAF	4	1	500 kcmil	AFPML6X	36"
	Dual	6X	AMB3120DCAF	8	1	500 kcmil	AFPML6XW	36"

Provisional Main Lug Kit

Main Amps	Single or Dual Configuration	Module "X" Height	Product Number	Max. Wires Per Phase	Cover Plate Kit Included Product Number	Min. Box Width
250	Single	6X	AMB3120NF	4	AFPML6X	36"
	Dual	6X	AMB3120NF	4	AFPML6X	36"
400	Single	6X	AMB3120NF	4	AFPML6X	36"
	Dual	6X	AMB3120NF	4	AFPML6X	36"
600	Single	6X	AMB3120NF	4	AFPML6X	36"
	Dual	6X	AMB3120NF	4	AFPML6X	36"
800	Single	6X	AMB3120NF	4	AFPML6X	36"
	Dual	6X	AMB3120DNF	8	AFPML6XW	36"
1200	Single	6X	AMB3120NF	4	AFPML6X	36"
	Dual	6X	AMB3120DNF	8	AFPML6XW	36"



# Panelboards Spectra™ Series Panelboards

PCU Selection  
Order from the Customer Service Center  
Available in Spectra™ Plug-in Only

### Spectra™ Series PCU Selection Guide

(Ref DET-104) Specify Overload Relay Amps  
(Included w/PCU)

**Description:** 15hp max, 22A, 600V max

**Configuration:** 3PH, 3W, & ground; all units are 4X height, 120V control.

Pilot Device	Mount	Product Number <sup>1</sup>
Yes	Double	APCU151FNDDPD**
Yes	Single	APCU151FNDDPSX*
No	Double	APCU151FNDDND**
No	Single	APCU151FNDDNSX*

<sup>1</sup>Replace \* with required overload range from table.

### Spectra™ PCU Control Power Transformer Kits

One kit required per panel unless an external, 120VAC is brought into the panel.

Continuous kVA	Primary Voltage <sup>2</sup>	Capacity	Product Number
.200	600	Standard	APCUCKA200
.300	600	Extra	APCUCKA300
.200	480/240	Standard	APCUCKB200
.300	480/240	Extra	APCUCKB300
.200	208	Standard	APCUCKC200
.300	208	Extra	APCUCKC300

<sup>2</sup>Secondary voltage is 120VAC.

### PCU Overload Selection

*	Overload Range
B	0.16-0.26A
C	0.25-0.41A
D	0.40-0.65A
F	0.65-1.1A
G	1.0-1.5A
H	1.3-1.9A
J	1.8-2.7A
K	2.5-4.1A
L	4.0-6.3A
M	5.5-8.5A
N	8.0-12.0A
P	10.0-16.0A
S	14.5-18.0A
T	17.5-22.0A
X	BLANK

### Spectra™ PCU Kits

Description	Product Number
Spectra PCU Pilot Light Option (Kit includes red and green pilot lights)	APCUKPLT
Spectra PCU Wiring Kit (Optional kit for remote wiring)	APCUWK
Spectra PCU Expansion Kit to expand or rebuild PCU units)	APCUEKAF (left side)
	APCURKAF (right side)
Spectra PCU Blank Cans (Provides space for future PCU starters, other devices)	4X APCUDCAN4X
	7X APCUDCAN7X



## Interior, Enclosure Options

### Bus Bars

Description
<b>Copper 1000 Amp/sq-in. Main Vertical Bus</b>
Silver plated copper in lieu of silver plated aluminum
<b>Aluminum 600 Amp/sq-in. Main Bus Density</b>
Reduces current density from 750 amps/sq-in. to 600 amps/sq-in.
<b>Copper 800 Amp/sq-in. Main Bus Density</b>
Reduces current density from 1000 amps/sq-in to 800 amps/sq-in.

### Locking Devices

Frame Style	Description	Product Number
<b>Padlocking Device (single padlock)</b>		
Q <sup>1</sup>	THQB, THHQB	THP100
E	TEY	TEYPLD1
FC	FCS, FCV, FCN, FCH, FCL, FCPF	FCPLD
SE, E	TEB, TED, THED	TEFPLD1
	SED, SEH, SEL, SEP	SEPLD
FE	FES, FEV, FEN, FEH, FEL, FEPE	Breaker not available at time of printing
QD	TQD, THQD	TQDPLD1
SF, F	SFH, SFL, SFP	SEPLD
SG	SGD, SGH, SGL, SGP	SGPLD
FG	FGV, FGN, FGH, FGL, FGP, FGPF	FGPLD
SK, K	SKH, SKL, SKP	SKPLD
<b>Handle Locking (nonpadlocking)</b>		
Q <sup>1</sup>	THQB, THHQB	THL103
E	TEB, TED, THED	TLD3

<sup>1</sup>Not available for ground fault breakers.

### Locking Devices EUSERC Approved—Factory Installed Only

Breaker Type	Product Number
TQD	TQDPLD2
FC	FCS, FCV, FCN, FCH, FCL, FCPE
E150	TEDPLD2
SE150, SF250 <sup>2</sup>	SEFPLD2
FE	FES, FEV, FEN, FEH, FEL, FEPE
SG600	SGPLD2
FG	FGV, FGN, FGH, FGL, FGP, FGPE
J600	TJKPLD2
SK1200	SKPLD2

<sup>2</sup>Field installable

### Equipment Ground Bars

Spectra™ grounding kits are sized according to the number of panel circuits (one per circuit or space).

Description
Bondable to box—includes bonding strap and main terminal
Insulated/isolated—includes main terminal

### Enclosures (Box)

Description
Painted/Increased Gage
One option provides 12 gage box painted ANSI 61 gray (not available separately)
NEMA 3R
NEMA 12
NEMA 4X Stainless Steel
Wide Box (increased gutter space)
To increase to 31" from 27" box
To increase to 36" from 31" box
To increase to 44" from 40" box
To increase to 44" from 36" box
Narrow Box <sup>4</sup>
To decrease to 27" from 36" box (circuit breakers only)
To decrease to 36" from 44" box
Box skirt — 12" high
Touch-up Paint
ANSI 61 gray, 12 oz. can

<sup>4</sup>Narrow box option limited to panels with maximum 600-amp circuit breaker feeders and 400-amp fusible feeders with T or J fuse clips. This option single branches some double branched devices and may result in additional sections. See page 11-33 and 11-34 for sizing information.

### Fronts

Standard Arrangement	27"	31"	36"	40"	44"
	4 piece surface only (no door)				

Optional regular door (27W, surface only)

Optional door <sup>5,6</sup> within a door front

Optional front hinged to box surface only

<sup>5</sup>Specify surface or flush.  
<sup>6</sup>Not available in 27" wide.

### Front Modifications

Description
Lexan Cardholder for fronts with doors
Lamicoid Nameplate (1 per panel)
Yale 511S Spring Bolt Lock with Rosette Sleeve
Corbin 15767 Latch Bolt
3 pt Catch and Vault Handle
Permanent Number Tabs #1-49
Permanent Number Tabs #1-99



### TVSS (Transient Voltage Surge Suppression)

Product Number	System Voltage	Panel Width	X Height	Panel Type	Surge Current Capability (per model)
ATME	120/208V, 240V Delta, 120/240V Delta, 120/240V Delta, 277/480V, 480V Delta	27" - 44"	7X	Plug-in/ Bolt-on	65ka
	80ka				
ATHE	120/208V, 240V Delta, 120/240V Delta, 120/240V Delta, 277/480V, 480V Delta	27" - 44"	7X	Plug-in/ Bolt-on	100ka
					150ka
					150ka
					200ka

\*Field installable kits are available for adding to existing boards.

\*Kits include: TVSS unit, 3 cover sizes, cover mounting brackets and cable.

\*Add a "K" to the end of the full Product Number for the kit number.

### Energy Management Meters

Product Number	System Voltage	Phase/ Wire	Ship Cycle
EPM2200/ EPM6000/ EPM7000	600/347V	3P 4W/3P 3W	N
	480V	3P 4W/3P 3W	
	208/120V	3P 4W	
PQM Meter Module	600/347V	3P 4W/3P 3W	N
	480V	3P 4W/3P 3W	
	240V	3P 3W	
	240/120V HI-Leg	3P 4W	
	208/120V	3P 4W	
PQMII Meter Module	600/347V	3P 4W/3P 3W	N
	480V	3P 4W/3P 3W	
	240V	3P 3W	
	240/120V HI-Leg	3P 4W	
	208/120V	3P 4W	

7X required for panel distribution section mounting

Fits in 27", 31", 36", 40" and 44" wide sections



# Panelboards

## Spectra™ Series Panelboards

### Integrated Submetering Panelboard

Submetering lets you measure and bill energy use (electrical, water, gas) in master-metered commercial and/or residential buildings. Suitable for either new construction or retrofit, the Spectra™ Series Integrated Submetering Panelboard combines the benefits of a multi-tenant digital meter with a reliable GE Spectra™ Series panelboard.

#### Save Valuable Real Estate

GE's fully-integrated solution maximizes valuable real estate by combining meters, current transformers, communications and overload protection into a single UL Listed, factory-assembled panel. It requires only a fraction of the space needed for traditional modular metering.

#### Lower Construction Costs

Because this panelboard requires no special communications wiring, you'll reduce wire, conduit and installation costs. Individual branch circuit readings communicate through power line communication. All in all, it's lighter, more flexible, faster and easier to install than conventional utility metering.

#### Save Time

Fully assembled and wired in the factory.

#### Features and benefits

- Factory assembled/wired internal meters minimize installation labor
- Factory installed/wired CTs eliminate lengthy wiring runs and wiring errors
- Small footprint takes up less wall space than separate panels and meters
- UL Listed
- Communication:
  - Power line communication standard on all meters
  - Optional Modbus RS-485 communication
  - Up to 48 pulse inputs to capture energy data from other pulse-type energy devices (water, gas, steam meters)
- IEC optical front panel interface for programming
- Real-time, per-phase viewing of voltage, current, power factor, phase angle, watts, VARs, VA and frequency
- Event reporting with time and date stamps
  - Local LCD display
  - Push-button scroll
  - 32-digit liquid crystal display (16 digit x 2 rows)
  - Programmable display scroll and decimal place display
- Meets ANSI C12.1 and C12.16 revenue certifiable accuracy specifications and Canada (AE-1148)
- Data can be accessed and collected through third party read-bill-collect service or, with Modbus option, the internal EPM 4000 platform utilizes GE's Energy Aggregator billing software, an ideal web-based solution for tracking and monitoring energy consumption. Energy Aggregator allows for the creation of utility rate structures and automatic billing generation.



#### Specifications

Panel Type	Spectra Bolt-On (SBO)
Certifications	UL, cUL
Services	1P3W, 3P3W, 3P4W
Voltages	120/240V, 120/208V, 480/277V
Main Amps	250, 400, 600, 800, 1200
Main Types	SF, SG, SK
Busing	Cu
Feeder Types	TED, TQD, THQD, SE, SF
Feeder Amps	15-250A
Max Fully Rated AIC Ratings	65kAIC
Branch Devices	24-2 pole max.; 18-3 pole max.
No. of Meter Points/Panel	6, 9, 12, 15, 18, 21, 24
Series Ratings	65kAIC
Meter Specifications	Per EPM 4000 Brochure

#### Typical Dimensions

Tenants	Panel Dimensions (inches)
6	65H x 40W x 11.5D
12	76H x 40W x 11.5D
18/24	89H x 44W x 11.5D

#### Example of 6-unit Wiring Diagram

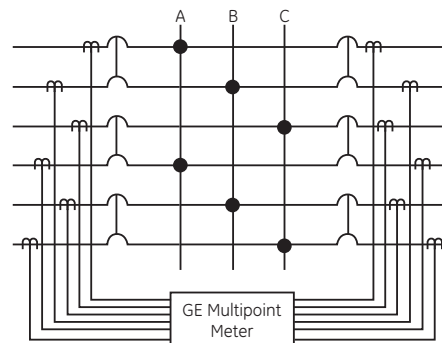



# Panelboards Spectra™ Series Panelboards Renewal Parts

Modular Concept

Order all components from Customer Service Center

Fig. 1.1 is a front view of a typical Spectra™ Series fusible panelboard.

Fig. 1.2 is also a front view, but with the front (4 piece trim), all fusible switches, and all filler plates removed.

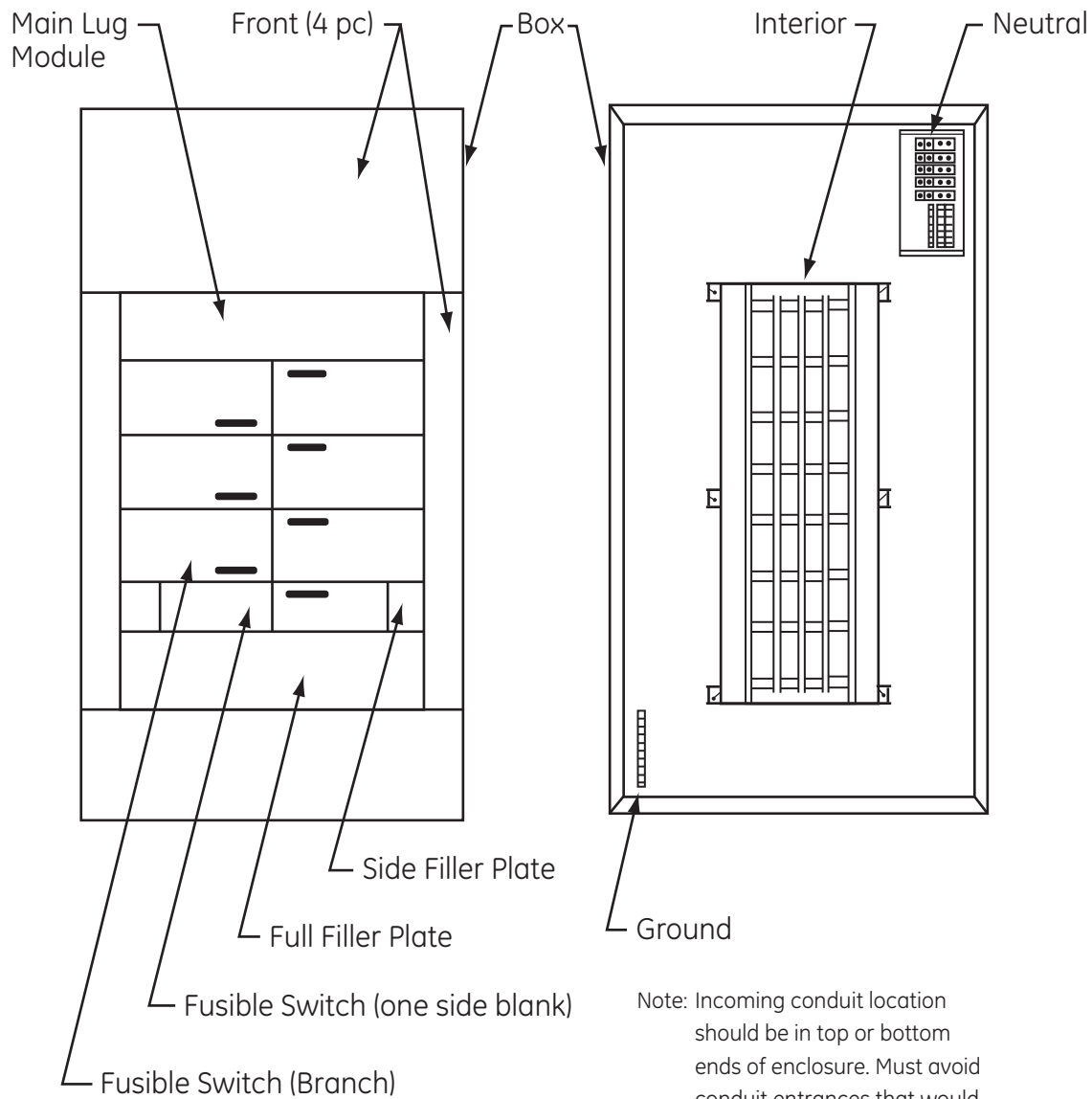

Fig. 1.1

Fig. 1.2



# Panelboards

## Spectra™ Series Panelboards

### Renewal Parts

Circuit Breaker Sizing

## Section 11

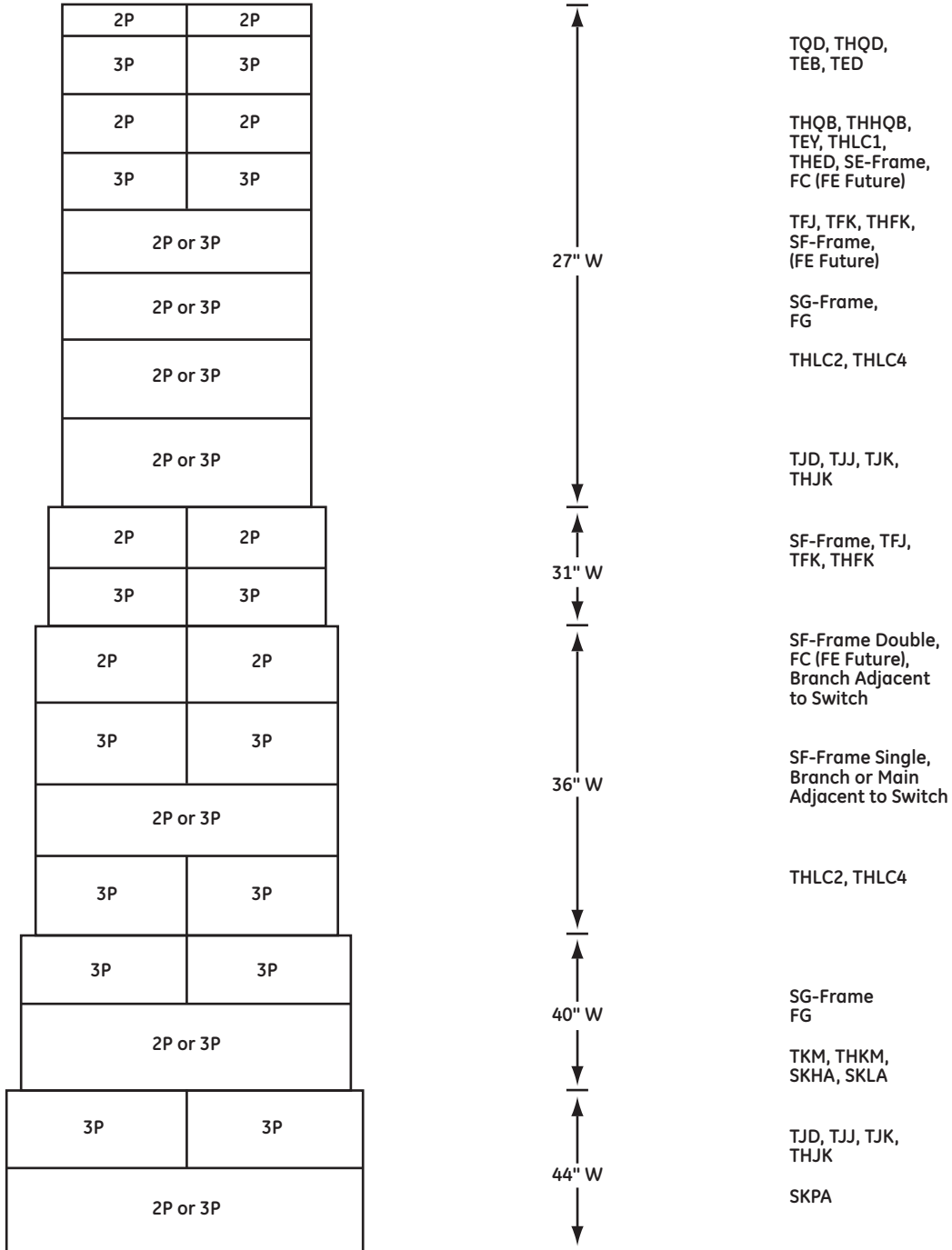

# Panelboards Spectra™ Series Panelboards

# Section 11

Replacement Boxes and Fronts  
Order from the Customer Service Center

## Type APB NEMA 1 Enclosure

Width	Height	Interior X-Height	Modification	Product Number	
27"	65"	18X	11.50"D, Std Gauge	APB2765AS	
			11.50"D, Painted/Heavy Gauge	APB2765ASP	
			14.25"D, Std Gauge	APB2765A	
		23X	14.25"D, Painted/Heavy Gauge	APB2765AP	
			11.50"D, Std Gauge	APB2765BS	
			11.50"D, Painted/Heavy Gauge	APB2765BSP	
	75"	28X	14.25"D, Std Gauge	APB2765B	
			14.25"D, Painted/Heavy Gauge	APB2765BP	
			11.50"D, Std Gauge	APB2765CS	
		28X	11.50"D, Painted/Heavy Gauge	APB2765CSP	
			14.25"D, Std Gauge	APB2765C	
			14.25"D, Painted/Heavy Gauge	APB2765CP	
	89"	28X	11.50"D, Std Gauge	APB2775S	
			11.50"D, Painted/Heavy Gauge	APB2775SP	
			14.25"D, Std Gauge	APB2775	
		33X, 38X	14.25"D, Painted/Heavy Gauge	APB2775P	
			11.50"D, Std Gauge	APB2789S	
			11.50"D, Painted/Heavy Gauge	APB2789SP	
	31"	65"	18X	14.25"D, Std Gauge	APB2789
				14.25"D, Painted/Heavy Gauge	APB2789P
				11.50"D, Std Gauge	APB3165A
			23X	11.50"D, Painted/Heavy Gauge	APB3165AP
				14.25"D, Std Gauge	APB3165AD
				14.25"D, Painted/Heavy Gauge	APB3165ADP
75"		28X	11.50"D, Std Gauge	APB3165B	
			11.50"D, Painted/Heavy Gauge	APB3165BP	
			14.25"D, Std Gauge	APB3165BD	
		28X	14.25"D, Painted/Heavy Gauge	APB3165BDP	
			11.50"D, Std Gauge	APB3165C	
			11.50"D, Painted/Heavy Gauge	APB3165CP	
89"		23X, 28X	14.25"D, Std Gauge	APB3165CD	
			14.25"D, Painted/Heavy Gauge	APB3165CDP	
			11.50"D, Std Gauge	APB3175	
		23X, 28X	11.50"D, Painted/Heavy Gauge	APB3175P	
			14.25"D, Std Gauge	APB3175D	
			14.25"D, Painted/Heavy Gauge	APB3175DP	
96"		33X, 38X	11.50"D, Std Gauge	APB3189	
			11.50"D, Painted/Heavy Gauge	APB3189P	
			14.25"D, Std Gauge	APB3189D	
		38X, 43X	14.25"D, Painted/Heavy Gauge	APB3189DP	
			11.50"D, Std Gauge	APB3196A	
			11.50"D, Painted/Heavy Gauge	APB3196AP	
48X	48X	14.25"D, Std Gauge	APB3196AD		
		14.25"D, Painted/Heavy Gauge	APB3196ADP		
		11.50"D, Std Gauge	APB3196B		
	48X	11.50"D, Painted/Heavy Gauge	APB3196BP		
		14.25"D, Std Gauge	APB3196BD		
		14.25"D, Painted/Heavy Gauge	APB3196BDP		

## Type APB NEMA 1 Enclosure (Continued)

Width	Height	Interior X-Height	Modification	Product Number
36"	65"	18X, 23X, 28X	11.50"D, Std Gauge	APB3665
			11.50"D, Painted/Heavy Gauge	APB3665P
			16.25"D, Std Gauge	APB3665D
		23X, 28X	16.25"D, Painted/Heavy Gauge	APB3665DP
			11.50"D, Std Gauge	APB3675
			11.50"D, Painted/Heavy Gauge	APB3675P
	75"	33X, 38X	16.25"D, Std Gauge	APB3675D
			16.25"D, Painted/Heavy Gauge	APB3675DP
			11.50"D, Std Gauge	APB3689
		38X, 43X, 48X	11.50"D, Painted/Heavy Gauge	APB3689P
			16.25"D, Std Gauge	APB3689D
			16.25"D, Painted/Heavy Gauge	APB3689DP
	96"	18X, 23X	11.50"D, Std Gauge	APB3696
			11.50"D, Painted/Heavy Gauge	APB3696P
			16.25"D, Std Gauge	APB3696D
		23X, 28X	16.25"D, Painted/Heavy Gauge	APB3696DP
			11.50"D, Std Gauge	APB4065
			11.50"D, Painted/Heavy Gauge	APB4065P
	40"	33X, 38X	14.25"D, Std Gauge	APB4065D
			14.25"D, Painted/Heavy Gauge	APB4065DP
			11.50"D, Std Gauge	APB4075
		38X, 43X, 48X	11.50"D, Painted/Heavy Gauge	APB4075P
			14.25"D, Std Gauge	APB4075D
			14.25"D, Painted/Heavy Gauge	APB4075DP
44"	18X, 23X	11.50"D, Std Gauge	APB4089	
		11.50"D, Painted/Heavy Gauge	APB4089P	
		14.25"D, Std Gauge	APB4089D	
	23X, 28X	14.25"D, Painted/Heavy Gauge	APB4089DP	
		11.50"D, Std Gauge	APB4096	
		11.50"D, Painted/Heavy Gauge	APB4096P	
48"	18X, 23X	14.25"D, Std Gauge	APB4096D	
		14.25"D, Painted/Heavy Gauge	APB4096DP	
		11.50"D, Std Gauge	APB4465	
	23X, 28X	11.50"D, Painted/Heavy Gauge	APB4465P	
		16.25"D, Std Gauge	APB4465D	
		16.25"D, Painted/Heavy Gauge	APB4465DP	
48"	33X, 38X	11.50"D, Std Gauge	APB4475	
		11.50"D, Painted/Heavy Gauge	APB4475P	
		16.25"D, Std Gauge	APB4475D	
	38X, 43X, 48X	16.25"D, Painted/Heavy Gauge	APB4475DP	
		11.50"D, Std Gauge	APB4489	
		11.50"D, Painted/Heavy Gauge	APB4489P	
48"	33X, 38X	16.25"D, Std Gauge	APB4489D	
		16.25"D, Painted/Heavy Gauge	APB4489DP	
		11.50"D, Std Gauge	APB4496	
	38X, 43X, 48X	11.50"D, Painted/Heavy Gauge	APB4496P	
		16.25"D, Std Gauge	APB4496D	
		16.25"D, Painted/Heavy Gauge	APB4496DP	



# Panelboards Spectra™ Series Panelboards

Replacement Boxes and Fronts  
Order from the Customer Service Center

### Type APB NEMA 3R and 12 Enclosures

Width	Depth	Height	Interior X-Height <sup>1</sup>	Product Number <sup>2</sup>
27"	14.25"	65"	18X	APB(D,R)276518(B,T)
			23X	APB(D,R)276523(B,T)
			28X	APB(D,R)276528(B,T)
		75"	28X	APB(D,R)277528(B,T)
			33X	APB(D,R)278933(B,T)
31"	14.25"	65"	38X	APB(D,R)278938(B,T)
			18X	APB(D,R)316518(B,T)
			23X	APB(D,R)316523(B,T)
		75"	28X	APB(D,R)316528(B,T)
			23X	APB(D,R)317523E(B,T)
36"	16.25"	65"	23X GF	APB(D,R)317523E(B,T)
			28X	APB(D,R)317528(B,T)
			33X	APB(D,R)318933(B,T)
		75"	38X	APB(D,R)318938(B,T)
			18X	APB(D,R)366518(B,T)
40"	14.25"	65"	23X	APB(D,R)366523E(B,T)
			28X	APB(D,R)366528(B,T)
			23X	APB(D,R)367523E(B,T)
		75"	23X DM	APB(D,R)367523E(B,T)
			28X	APB(D,R)367528(B,T)
44"	16.25"	65"	33X	APB(D,R)368933(B,T)
			38X	APB(D,R)368938(B,T)
			18X	APB(D,R)406518(B,T)
		75"	23X	APB(D,R)406523(B,T)
			23X	APB(D,R)407523E(B,T)
44"	16.25"	65"	23X DM	APB(D,R)407523E(B,T)
			28X	APB(D,R)407528(B,T)
			18X	APB(D,R)446518(B,T)
		75"	23X	APB(D,R)446523(B,T)
			23X	APB(D,R)447523(B,T)
75"	75"	23X DM	APB(D,R)447523E(B,T)	
		28X	APB(D,R)447528(B,T)	

<sup>1</sup>GF = Ground Fault

DM = Dual Main, Ground Fault, 200% Neutral

<sup>2</sup>(D,R) D = NEMA 12

R = NEMA 3R

(B,T) B = Bottom Feed

T = Top Feed

### 200% Neutral

Provides second neutral assembly of equal amperage rating.

### Compression Lugs

#### Main Lugs, Neutral Lugs and Fusible Switches

The standard sizes and number of mechanical lugs are shown on page 11-28.

Description	Description
#12 1/0	500 kcmil
2/0-300 kcmil	600-750 kcmil



# Panelboards

## Spectra™ Series Panelboards

### Renewal Parts

Product Number Structure

## Section 11

### Panelboard Interior – Type APN

Example:	<b>APN</b>	<b>38</b>	<b>06</b>	<b>U</b>	<b>B4</b>
		<u>"X" Hgt of Interior</u>	<u>Ampere Rating</u>	<u>Interior Type</u>	<u>Modification Code</u>
		18 = 18X 23 = 23X 28 = 28X 33 = 33X 38 = 38X 43 = 43X 48 = 48X 53 = 53X	02 = 200A 04 = 400A 06 = 600A 08 = 800A 12 = 1200A	U = Unassembled	Blank = Standard (Aluminum Bus) B4 = Copper Bus (100A/sq in.)

### Panelboard Interior – Type APNB

Example:	<b>APNB</b>	<b>38</b>	<b>06</b>	<b>U</b>	<b>B4</b>
		<u>"X" Hgt of Interior</u>	<u>Ampere Rating</u>	<u>Interior Type</u>	<u>Modification Code</u>
		18 = 18X 23 = 23X 28 = 28X 33 = 33X 38 = 38X 43 = 43X 48 = 48X 53 = 53X	02 = 200A 04 = 400A 06 = 600A 08 = 800A 12 = 1200A	U = Unassembled	Blank = Standard (Aluminum Bus) B4 = Copper Bus (100A/sq in.)

### Panelboard Box – Type APB

Example:	<b>APB</b>	<b>36</b>	<b>89</b>	
		<u>Box Width</u>	<u>Box Height</u>	<u>Modification Code</u>
		27 = 27" 36 = 36" 44 = 44"	65 = 65" 75 = 75" 89 = 89" 96 = 96"	Blank = Any box except APB2765 A = For APB2765 with 18X interior B = For APB2765 with 23X interior C = For APB2765 with 28X interior

### Panelboard Front – Type APF

Example:	<b>APF</b>	<b>89</b>	<b>38</b>	
		<u>Box Height</u>	<u>"X" Hgt of Interior</u>	<u>Modification Code</u>
		65 = 65" 75 = 75" 89 = 89" 96 = 96"	18 = 18X 23 = 23X 28 = 28X 33 = 33X 38 = 38X 43 = 43X 48 = 48X 53 = 53X	Blank = For Std Box (36" wide) S = For Slim Box (27" wide) W = For Wide Box (44" wide) E = Extra Line Gutter Space for Dual Main Neutral N = Nonvented Front (for 250A only)



# Panelboards Spectra™ Series Panelboards

# Section 11

## Renewal Parts

Product Number Structure (Continued)

### Disconnect Switches – Type ADS

Example:	<b>ADS</b>	<b>3</b>	<b>6</b>	<b>200</b>	<b>H</b>	<b>D</b>	<b>FP</b>
		No. of Poles	Voltage Rating	Ampere Rating	Fuse Type	Unit Type	Accessory Code
		2 = 2 poles 3 = 3 poles	2 = 240V 6 = 600V	030 = 30A 060 = 60A 100 = 100A 200 = 200A 400 = 400A 600 = 600A 800 = 800A 120 = 1200A	H = Class H, R, or K T = Class T J = Class J L = Class L	D = Double Unit with 2 switches S = Single Switch in a Double Unit B = Single Branch Unit M = Main Switch K = Expansion Kit (switch only ... no module)	FP = With Filler Plate Kit (side fillers)

### Circuit Breaker Mounting Modules – Type AMC

Example:	<b>AMC</b>	<b>6</b>	<b>EB</b>	<b>S</b>	<b>FP</b>
		No. of Total CB Poles on Module	Breaker Frames	Unit Type	Accessory Code
		6 = 6 poles (3-pole breakers, double branched) 4 = 4 poles (2-pole breakers, double branched) 3 = 3 poles (3-pole breakers, single branched) 2 = 2 poles (2-pole breakers, single branched)	QB = THQB, THQB EY = TEY EB = TEB, TED, THED, SED, SEH, SEL, SEP FDB = FC FEB = FE Future FJ = TFJ, TFK, THFK, TFL, SFH, SFL, SFP JK = TJD, TJJ, TJK, THJK, TJ4V, TJL4V LB = TLB4, THLC2, THLC4 GB or GM = SGD, SGH, SGL, SGP FGB = FG KM = TKM, THKM, TK4V, TKL4V, SKH, SKL, SKP FB = FB	Blank = Std. S = Special Type to allow TFL, SE and SF to be mounted adjacent to a switch	FP = With Filler Plate Kit (full width plates with cutouts for handles, etc.)

### Bolt-on Strap Kits – Type AMCB

Example:	<b>AMCB</b>	<b>6</b>	<b>EB</b>	<b>B</b>	<b>FP</b>
		Poles	C/B Frame	Mounting	Accessory Code
		2 3 4 6	EB = SE, TEB, T(H)ED EY = TEY FDB = FC FE = FEB Future FJ = SF G = SG FG = FGB K = SK, T(H)KM LB = THLC2,4 QD = T(H)QD SE = SE, THED	Blank = Main or Branch B = Branch Only M = Main Only	FP = With Filler Plate Kit (full width plates with cutouts for handles, etc)



**Neutral Kits – Type ANK**

Example:	<b>ANK</b>	<b>800</b>	<b>D</b>
		Ampere Rating	Modification Code
		250 = 250A 400 = 400A 600 = 600A 800 = 800A 100 = 1000A 120 = 1200A	Blank = Std (single main) D = Dual Main GF = Ground Fault Only

**Equipment Ground Kits – Type AEG**

Example:	<b>AEG</b>	<b>21</b>	<b>S</b>
		No. of Circuits	Modification Code
		10 21 31	Blank = Std (bonded) S = Insulated/Isolated

**NEMA 1 Box Extensions - Type APB<sup>1</sup>**

Example:	<b>APB</b>	<b>27</b>	<b>E</b>
		Width	Extension Depth
		27 31 36 40 44	E = 12H, 11.5D, 31/36/40/44W 12H, 14.25D, 27W ED = 12H, 14.25D, 31/40W 12H, 16.25D, 36/44W ES = 12H, 11.5D, 27W

<sup>1</sup>Note: Available in SPEEDI under "EXT" code on modifications screen. Also available by product number through ONE STOP.



**Product Features**

- Use to mount main or branch circuit breakers into panelboard. Breakers bolt on to the mounting modules.
- FP suffix indicates that all AFP filler plates, with cutouts for handles, are included to fit all applicable box widths. On double branch modules, filler plates to cover any unused breaker poles are also included.
- Circuit breakers not included in module price.
- Includes all necessary hardware.

**Circuit Breaker Mounting Modules Plug-In Spectra™ 3-pole**

Mounting Arrangement	Maximum Breaker Amperage	Breaker Frame	X Height	Filler Plate Kit Product Number	Box Width Range	Product Number
Double Branch	100	THQB or THHQB	3X	AFP3QBD	27", 31", 36" 40", 44"	AMC6QBFP
Double Branch	100	TEY	3X	AFP3EYD	27", 31", 36" 40", 44"	AMC6EYFP
Double Branch	100	FBV, FBN, FBH, or FBL	3X	AFP3FBD	27", 31", 36", 40", 44"	AMC6FBFP
Double Branch	100	FCS, FCV, FCN, FCH or FCL	3X	AFP3FDD	27", 31", 36", 40", 44"	AMC6FDBFP
Double Branch	150	TEB, TED, THED, SEDA SEHA, SELA or SEPA	3X	AFP3SED	27", 31", 36" 40", 44"	AMC6EBFP
Double Branch	225	TQD or THQD	3X	AFP3QDD	27", 31", 36" 40", 44"	AMC6QDFP
Double Branch	225	TFJ or TFK or THFK	3X	AFP3TFD	31", 36", 40", 44"	AMC6FJFPTF
Double Branch	250	SFHA or SFLA or SFPA	3X	AFP3SFD	31", 36", 40" 44"	AMC6FJFP <sup>1</sup>
Double Branch	400	TJD or TJJ	6X	AFP6TJD	44"	AMC6JKFP
Double Branch	600	TJK or THJK	6X	AFP6TJD	44"	AMC6JKFP
Double Branch	600	FGL, FGN, FGH or FGP	4X	AFP4FGD	40", 44"	AMC6FGBFP
Double Branch	600	SGDA or SGHA or SGLA or SGPA	4X	AFP4SGD	40", 44"	AMC6GBFP <sup>2</sup>
Double Branch Adjacent to Switch	100	FCS, FCV, FCN, FCH or FCL	4X	AFP4FDD	36", 44"	AMC6FDSFP
Double Branch Adjacent to Switch	150	SEDA or SEHA or SELA or SEPA	4X	AFP4SED	36", 44"	AMC6EBSFP
Double Branch Adjacent to Switch	250	SFHA or SFLA or SFPA	4X	AFP4SFD	36", 44"	AMC6FLSFP
Single Branch or Main	225	TFJ or TFK or THFK	3X	AFP3TFS	27", 31", 36", 40", 44"	AMC3FJFPTF
Single Branch or Main	250	SFHA or SFLA or SFPA	3X	AFP3SFS	27", 31", 36", 40", 44"	AMC3FJFP <sup>1</sup>
Single Branch or Main	400	TJD or TJJ	6X	AFP6TJS	27", 31", 36", 40", 44"	AMC3JKFP
Single Branch or Main	600	TJK or THJK	6X	AFP6TJS	27", 31", 36", 40", 44"	AMC3JKFP
Single Branch or Main	600	FGV, FGN, FGH or FGP	4X	AFP4FGS	27", 31", 36", 40", 44"	AMC3FGMFP
Single Branch or Main	600	SGDA or SGHA or SGLA or SGPA	4X	AFP4SGS	27", 31", 36", 40", 44"	AMC3GMFP
Single Branch or Main	1200	TKM or THKM or SKHA or SKLA	6X	AFP6SKS	40", 44"	AMC3KMFP
Single Branch or Main	1200	SKPA	6X	AFP6SKS	44"	AMC3KMFP
Single Branch or Main Adjacent to Switch	250	SFHA or SFLA or SFPA	4X	AFP4SFS	36", 44"	AMC3FLSFP

**Circuit Breaker Mounting Modules Plug-In Spectra™ 2-pole**

Mounting Arrangement	Maximum Breaker Amperage	Breaker Frame	X Height	Filler Plate Kit Product Number	Box Width Range	Product Number
Double Branch	100	THQB or THHQB	3X	AFP3QBD	27", 31", 36" 40", 44"	AMC6QBFP
Double Branch	100	TEY	3X	AFP3EYD	27", 31", 36" 40", 44"	AMC6EYFP
Double Branch	100	FCS, FCV, FCN, FCH or FCL	3X	AFP3FDD	27", 31", 36", 40", 44"	AMC4FDBFP
Double Branch	150	TEB or TED	3X	AFP2TED	27", 31", 36" 40", 44"	AMC4EBFP
Double Branch	150	SEDA or SEHA or SELA or SEPA, THED	3X	AFP3SED	27", 31", 36" 40", 44"	AMC4SEFP
Double Branch	225	TQD or THQD	2X	AFP2QDD	27", 31", 36" 40", 44"	AMC4QDFP
Double Branch	225	TFJ or TFK or THFK	3X	AFP3TFD	31", 36", 40", 44"	AMC4FJFPTF
Double Branch	250	SFHA or SFLA or SFPA	3X	AFP3SFD	31", 36", 40" 44"	AMC4FJFP <sup>1</sup>
Double Branch	400	TJD or TJJ	6X	AFP6TJD	44"	AMC4JKFP
Double Branch	600	TJK or THJK	6X	AFP6TJD	44"	AMC4JKFP
Double Branch	600	FGV, FGN, FGH or FGP	4X	AFP4FGD	40", 44"	AMC4FGBFP
Double Branch	600	SGDA or SGHA or SGLA or SGPA	4X	AFP4SGD	40", 44"	AMC4GBFP <sup>2</sup>
Double Branch Adjacent to Switch	100	FCS, FCV, FCN, FCH or FCL	4X	AFP4FDD	36", 44"	AMC4FDSFP
Double Branch Adjacent to Switch	150	SEDA or SEHA or SELA or SEPA	4X	AFP4SED	36", 44"	AMC4EBSFP
Double Branch Adjacent to Switch	250	SFHA or SFLA or SFPA	4X	AFP4SFD	36", 44"	AMC4FLSFP
Single Branch or Main	225	TFJ or TFK or THFK	3X	AFP3TFS	27", 31", 36", 40", 44"	AMC2FJFPTF
Single Branch or Main	250	SFHA or SFLA or SFPA	3X	AFP3SFS	27", 31", 36", 40", 44"	AMC2FJFP <sup>1</sup>
Single Branch or Main	400	TJD or TJJ	6X	AFP6TJS	27", 31", 36", 40", 44"	AMC2JKFP
Single Branch or Main	600	TJK or THJK	6X	AFP6TJS	27", 31", 36", 40", 44"	AMC2JKFP
Single Branch or Main	600	FGV, FGN, FGH or FGP	4X	AFP4FGS	27", 31", 36", 40", 44"	AMC2FGMFP
Single Branch or Main	600	SGDA or SGHA or SGLA or SGPA	4X	AFP4SGS	27", 31", 36", 40", 44"	AMC2GMFP
Single Branch or Main	1200	TKM or THKM or SKHA or SKLA	6X	AFP6SKS	40", 44"	AMC2KMFP
Single Branch or Main	1200	SKPA	6X	AFP6SKS	44"	AMC2KMFP
Single Branch or Main Adjacent to Switch	250	SFHA or SFLA or SFPA	4X	AFP4SFS	36", 44"	AMC2FLSFP

<sup>1</sup>SE and SF breakers located adjacent to a fusible switch, PCU or TVSS require mounting modules suitable for mounting "Adjacent to Switch."

SGDA circuit breaker rated 400 amps maximum.

<sup>2</sup>THLC 1/2/4 breaker no longer available.

Note: 1X = 1 3/8" vertical panel space.





**Product Features**

- Module includes fusible switch and panelboard mounting connectors. Fuses not included.
- Class R Fuse Clip Kit (for field installation) included with all switches that accept Class R Fuses.
- FP suffix indicates that all AFP filler plates are included to fit applicable box widths.

**Branch Switch Modules Plug-In Spectra™ 240 Volts 3-pole**

Mounting Arrangement	Fuse Type	Switch Amperes	X Height	Side Filler Plate Kit Part Number	Box Width Range	Product Number
Double Branch-2 switches	H, R, or K	30	4X	AFP4X	36", 44"	ADS32030HDFP
Double Branch-2 switches	H, R, or K	60	4X	AFP4X	36", 44"	ADS32060HDFP
Double Branch-2 switches	H, R, or K	100	5X	AFP5X	36", 44"	ADS32100HDFP
Double Branch-2 switches	T	100	7X	AFP7T	36", 44"	ADS32100TDFP
Double Branch-2 switches	H, R, or K	200	7X	AFP7X2	44"	ADS32200HDFP
Double Branch-2 switches	T	200	7X	AFP7T	36", 44"	ADS32200TDFP
Double Branch-switch plus space	H, R, or K	30	4X	AFP4X	36", 44"	ADS32030HSFP
Double Branch-switch plus space	H, R, or K	60	4X	AFP4X	36", 44"	ADS32060HSFP
Double Branch-switch plus space	H, R, or K	100	5X	AFP5X	36", 44"	ADS32100HSFP
Single Branch	H, R, or K	200	7X	AFP7X	36", 44"	ADS32200HBFP
Single Branch	H, R, or K	400	10X	AFP10X	44"	ADS32400HBFP
Single Branch	T	400	10X	AFP10T	36", 44"	ADS32400TBFP
Single Branch	H, R, or K	600	10X	AFP10X	44"	ADS32600HBFP
Single Branch	T	600	10X	AFP10T	36", 44"	ADS32600TBFP

**Branch Switch Modules Plug-In Spectra™ 240 Volts 2-pole**

Mounting Arrangement	Fuse Type	Switch Amperes	X Height	Side Filler Plate Kit Part Number	Box Width Range	Product Number
Double Branch-2 switches	H, R, or K	30	4X	AFP4X	36", 44"	ADS22030HDFP
Double Branch-2 switches	H, R, or K	60	4X	AFP4X	36", 44"	ADS22060HDFP
Double Branch-2 switches	T	100	7X	AFP7T	36", 44"	ADS32100TDFP
Double Branch-2 switches	H, R, or K	100	5X	AFP5X	36", 44"	ADS22100HDFP
Double Branch-2 switches	H, R, or K	200	7X	AFP7X2	44"	ADS22200HDFP
Double Branch-2 switches	T	200	7X	AFP7T	36", 44"	ADS22200TD
Double Branch-switch plus space	H, R, or K	30	4X	AFP4X	36", 44"	ADS22030HSFP
Double Branch-switch plus space	H, R, or K	60	4X	AFP4X	36", 44"	ADS22060HSFP
Double Branch-switch plus space	H, R, or K	100	5X	AFP5X	36", 44"	ADS22100HSFP
Single Branch	H, R, or K	200	7X	AFP7X	36", 44"	ADS22200HBFP
Single Branch	T	200	7X	AFP7X	36", 44"	ADS22200TS
Single Branch	H, R, or K	400	10X	AFP10X	44"	ADS22400HBFP
Single Branch	T	400	10X	AFP10T	36", 44"	ADS22400TBFP
Single Branch	H, R, or K	600	10X	AFP10X	44"	ADS22600HBFP
Single Branch	T	600	10X	AFP10T	36", 44"	ADS22600TBFP

Note: 1X = 1 3/8" vertical panel space



**Product Features**

- Module includes fusible switch and panelboard mounting connectors. Fuses not included.
- Class R Fuse Clip Kit (for field installation) included with all switches that accept Class R Fuses.
- FP suffix indicates that all AFP filler plates are included to fit applicable box widths.

**Branch Switch Modules Plug-In Spectra™ 600 Volts 3-pole**

Mounting Arrangement	Fuse Type	Switch Amperes	X Height	Side Filler Plate Kit Part Number	Box Width Range	Product Number
Double Branch-2 switches	H, R, J, or K	30	4X	AFP4X	36", 44"	ADS36030HDFP
Double Branch-2 switches	H, R, J, or K	60	5X	AFP5X	36", 44"	ADS36060HDFP
Double Branch-2 switches	H, R, J, or K	100	5X	AFP5X	36", 44"	ADS36100HDFP
Double Branch-2 switches	H, R, or K	200	7X	AFP7X2	44"	ADS36200HDFP
Double Branch-2 switches	J	200	7X	AFP7T	36", 44"	ADS36200JDFP
Double Branch-switch plus space	H, R, J, or K	30	4X	AFP4X	36", 44"	ADS36030HSFP
Double Branch-switch plus space	H, R, J, or K	60	5X	AFP5X	36", 44"	ADS36060HSFP
Double Branch-switch plus space	H, R, J, or K	100	5X	AFP5X	36", 44"	ADS36100HSFP
Single Branch	H, R, or K	200	7X	AFP7X	36", 44"	ADS36200HBFP
Single Branch	H, R, or K	400	10X	AFP10X	44"	ADS36400HBFP
Single Branch	J	400	10X	AFP10T	36", 44"	ADS36400JBFP
Single Branch	T	400	10X	AFP10T	36", 44"	ADS36400TBFP
Single Branch	H, R, or K	600	10X	AFP10X	44"	ADS36600HBFP
Single Branch	J	600	10X	AFP10T	36", 44"	ADS36600JBFP
Single Branch	T	600	10X	AFP10T	36", 44"	ADS36600TBFP
Single Branch	L	800	19X	AFP19X	44"	ADS36800LBFP
Single Branch	L	1200	19X	AFP19X	44"	ADS36120LBFP

**Branch Switch Modules Plug-In Spectra™ 600 Volts 2-pole**

Mounting Arrangement	Fuse Type	Switch Amperes	X Height	Side Filler Plate Kit Part Number	Box Width Range	Product Number
Double Branch-2 switches	H, R, J, or K	30	4X	AFP4X	36", 44"	ADS26030HDFP
Double Branch-2 switches	H, R, J, or K	60	5X	AFP5X	36", 44"	ADS26060HDFP
Double Branch-2 switches	H, R, J, or K	100	5X	AFP5X	36", 44"	ADS26100HDFP
Double Branch-2 switches	T	100	7X		N/A	ADS26100TDFP
Double Branch-2 switches	H, R, or K	200	7X	AFP7X2	44"	ADS26200HDFP
Double Branch-2 switches	J	200	7X	AFP7T	36", 44"	ADS26200JDFP
Double Branch-switch plus space	H, R, J, or K	30	4X	AFP4X	36", 44"	ADS26030HSFP
Double Branch-switch plus space	H, R, J, or K	60	5X	AFP5X	36", 44"	ADS26060HSFP
Double Branch-switch plus space	H, R, J, or K	100	5X	AFP5X	36", 44"	ADS26100HSFP
Single Branch	H, R, or K	200	7X	AFP7X	36", 44"	ADS26200HBFP
Single Branch	J	200	7X	AFP7X	36"	ADS26200JSFP
Single Branch	H, R, or K	400	10X	AFP10X	44"	ADS26400HBFP
Single Branch	J	400	10X	AFP10T	36", 44"	ADS26400JBFP
Single Branch	T	400	10X	AFP10T	36", 44"	ADS26400TBFP
Single Branch	H, R, or K	600	10X	AFP10X	44"	ADS26600HBFP
Single Branch	J	600	10X	AFP10T	36", 44"	ADS26600JBFP
Single Branch	T	600	10X	AFP10T	36", 44"	ADS26600TBFP
Single Branch	L	800	19X	AFP19X	44"	ADS26800LBFP
Single Branch	L	1200	19X	AFP19X	44"	ADS26120LBFP

Note: 1X = 1 3/8" vertical space



**Mounting Hardware With Filler Plate, Straps and Brackets Bolt-On Spectra™**

Mounting kit with filler plate includes hardware straps, brackets and filler plate.

Filler plate kit includes filler plate and associated hardware only.

Mounting Arrangement	Breaker Frame	Number of Poles	Box Width Range	X Height	Product Number
Dual Mounted	TEB, TED	2-pole	27"-44"	2X	AMCB4EBFP
Dual Mounted	TEY	2-pole	27"-44"	3X	AMCB4EYFP
Dual Mounted	FBV, FBN, FBH, or FBL	2-pole	27"-44"	2X	AMCB4FBFP
Dual Mounted	FCS, FCV, FCN, FCH or FCL	2-pole	27", 31", 36", 40", 44"	3X	AMCB4FDBFP
Dual Mounted	TQD, THQD	2-pole	27"-44"	2X	AMCB4QDFF
Dual Mounted	THED, SED, SEH, SEL, SEP	2-pole	27"-44"	3X	AMCB4SEFP
Dual Mounted	TEB, TED, THED, SED, SEH, SEL, SEP	3-pole	27"-44"	3X	AMCB6EBFP
Dual Mounted	TEY	3-pole	27"-44"	3X	AMCB6EYFP
Dual Mounted	FBV, FBN, FBH, or FBL	3-pole	27"-44"	3X	AMCB6FBFP
Dual Mounted	FCS, FCV, FCN, FCH or FCL	3-pole	27", 31", 36", 40", 44"	3X	AMCB6FDBFP
Dual Mounted	TQD, THQD	3-pole	27"-44"	3X	AMCB6QDFF
Dual Mounted	SFH, SFL, SFP	2-pole	31"-44"	3X	AMCB4FJFP
Dual Mounted	SFH, SFL, SFP	3-pole	31"-44"	3X	AMCB6FJFP
Dual Mounted	TFJ, TFK, THFK	2-pole	36"-44"	2X	AMCB4FJPTF
Dual Mounted	TFJ, TFK, THFK	3-pole	36"-44"	3X	AMCB6FJPTF
Dual Mounted	FGV, FGN, FGH or FGP	2-pole	40", 44"	4X	AMCB4FGBFP
Dual Mounted	SGH, SGL, SGP	2-pole	40"-44"	4X	AMCB4GBFP
Dual Mounted	FGV, FGN, FGH or FGP	3-pole	40", 44"	4X	AMCB6FGBFP
Dual Mounted	SGH, SGL, SGP	3-pole	40"-44"	4X	AMCB6GBFP
Single Mounted	SFH, SFL, SFP	2-pole	27"-44"	3X	AMCB2FJFP
Single Mounted	TFJ, TFK, THFK	2-pole	27"-44"	3X	AMCB2FJPTF
Single Mounted	FGV, FGN, FGH or FGP	2-pole	27", 31", 36", 40", 44"	4X	AMCB2FGMFP
Single Mounted	SGH, SGL, SGP	2-pole	27"-44"	4X	AMCB2GMFP
Single Mounted	SFH, SFL, SFP	3-pole	27"-44"	3X	AMCB3FJFP
Single Mounted	TFJ, TFK, THFK	3-pole	27"-44"	3X	AMCB3FJPTF
Single Mounted	FGV, FGN, FGH or FGP	3-pole	27", 31", 36", 40", 44"	4X	AMCB3FGMFP
Single Mounted	SGH, SGL, SGP	3-pole	27"-44"	4X	AMCB3GMFP
Single Mounted	SKP	2-pole	27"-44"	6X	AMCB3LBFP
Single Mounted	SKH, SKL, SKP, TKM, THKM	2-pole	40"-44"	6X	AMCB2KMFP
Single Mounted	SKH, SKL, SKP, TKM, THKM	3-pole	40"-44"	6X	AMCB3KMFP

**Filler Plates Bolt-On Spectra™**

Filler plate kit includes filler plate and associated hardware only.

Mounting Arrangement	Breaker Frame	Number of Poles	Box Width Range	X Height	Product Number
Dual Mounted	TQD, THQD	2-pole	27"-44"	2X	AFP2QDD
Dual Mounted	TEB, TED	2-pole	27"-44"	2X	AFP2TED
Dual Mounted	TEY	2-, 3-pole	27"-44"	3X	AFP3EYD
Dual Mounted	FBV, FBN, FBH, or FBL	2-pole	27"-44"	2X	AFP2FBD
Dual Mounted	FBV, FBN, FBH, or FBL	3-pole	27"-44"	3X	AFP3FBD
Dual Mounted	TQD, THQD	3-pole	27"-44"	3X	AFP3QDD
Dual Mounted	TEB, TED, THED, SED, SEH, SEL, SEP	2-, 3-pole	27"-44"	3X	AFP3SED
Dual Mounted	SFH, SFL, SFP	2-, 3-pole	31"-44"	3X	AFP3SFD
Dual Mounted	TFJ, TFK, THFK	2-, 3-pole	36"-44"	2X, 3X	AFP3TFD
Dual Mounted	FGV, FGN, FGH or FGP	3-pole	40", 44"	4X	AFP4FGD
Dual Mounted	SGH, SGL, SGP	2-, 3-pole	40"-44"	4X	AFP4SGD
Single Mounted	SFH, SFL, SFP	2-, 3-pole	27"-44"	3X	AFP3SFS
Single Mounted	TFJ, TFK, THFK	2-, 3-pole	27"-44"	3X	AFP3TFS
Single Mounted	FGV, FGN, FGH or FGP	2-, 3-pole	27", 31", 36", 40", 44"	4X	AFP4FGS
Single Mounted	SGH, SGL, SGP	2-, 3-pole	27"-44"	4X	AFP4SGS
Single Mounted	SKP	2-pole	27"-44"	6X	AFP5LCS
Single Mounted	SKP, SKH, SKL, TKM, THKM	3-pole	44"-44"	6X	AFP6SKS

Notes: 1X = 1 3/8" vertical space. THLC 1/2/4 breaker no longer available.



# Panelboards Spectra™ Series Panelboards Renewal Parts

## Mounting Hardware

Order from the Customer Service Center

# Section 11

### Filler Plates Plug-In or Bolt-On Spectra™

Use to cover unused spaces.  
Includes filler plate support brackets and hardware.

Space X Height <sup>1</sup>	Box Width Range	Switchboard Section Widths	Product Number
1X	27", 31"	35	APP1S
2X	27", 31"	35	APP2S
3X	27", 31"	35	APP3S
4X	27", 31"	35	APP4S
5X	27", 31"	35	APP5S
6X	27", 31"	35	APP6S
1X	36", 40"	40	APP1
2X	36", 40"	40	APP2
3X	36", 40"	40	APP3
4X	36", 40"	40	APP4
5X	36", 40"	40	APP5
6X	36", 40"	40	APP6
1X	44"	45	APP1W
2X	44"	45	APP2W
3X	44"	45	APP3W
4X	44"	45	APP4W
5X	44"	45	APP5W
6X	044"	45	APP6W

<sup>1</sup> X-height: 1X = 1 3/8"

### Mounting Hardware Plug-In or Bolt-On Spectra™ ADS Switch Replacement Load Base Kits

Includes load base, clips and lugs.

Replacement for Load Base Part Number	Load Base Ampere Rating	Load Base - No. of Poles	Load Base Voltage	Product Number
ADS22030HD	-	-	-	331A1519G1
ADS32030HD	-	-	-	331A1519G2
ADS322060HD	-	-	-	331A1519G3
ADS32060HD	-	-	-	331A1519G4
ADS26030HD	-	-	-	331A1519G5
ADS36030HD	-	-	-	331A1519G6
ADS26060HD	-	-	-	331A1519G7
ADS36060HD	-	-	-	331A1519G8
ADS36200JD	-	-	-	331A1519G12
ADS26200JD	-	-	-	331A1519G16
ADS36200JM	-	-	-	331A1519G20
ADS26200JM	-	-	-	331A1519G22
-	100A	2-pole	240V & 600V	331A1519G9
-	100A	3-pole	240V & 600V	331A1519G10
-	100A	3-pole	240V & 600V	331A1519G14
-	100A	2-pole	240V & 600V	331A1519G18
-	200A	3-pole	240V & 600V	331A1519G11
-	200A	2-pole	240V & 600V	331A1519G13
-	200A	2-pole	240V & 600V	331A1519G15
-	200A	2-pole	240V & 600V	331A1519G17
-	200A	3-pole	240V & 600V	331A1519G19
-	200A	2-pole	240V & 600V	331A1519G21
-	400A	2-pole	240V & 600V	331A1545G1
-	400A	3-pole	240V & 600V	331A1545G3
-	400A	2-pole	240V & 600V	331A1545G5
-	400A	3-pole	240V & 600V	331A1545G7
-	600A	2-pole	240V & 600V	331A1545G2
-	600A	3-pole	240V & 600V	331A1545G4
-	600A	2-pole	240V & 600V	331A1545G6
-	600A	3-pole	240V & 600V	331A1545G8
-	400-1200A	-	-	331A1543G1

### Mounting Hardware Single Breaker Plug-In Spectra™

Included when ordering AMC module. Only required when mounting breaker on existing module.

Kit contains screws and washers to mount one circuit breaker on AMC circuit breaker mounting module.

Circuit Breaker Mounting Module Part Number	Product Number
AMC6EB	AHKE1
AMC4SE	
AMC4EB	
AMC6EBS	
AMC6EL	AHKEL1
AMC2FLS	AHKF1
AMC6FJ	
AMC4FJ	
AMC3FJ	
AMC2FJ	
AMC6FLS	
AMC3FLS	
AMC4FLS	
AMC2GM	AHKG1
AMC6GB	
AMC4GB	
AMC3GM	
AMC2JK	AHKJ1
AMC6JK	
AMC4JK	
AMC3JK	
AMC3LB	AHKLB1
AMC6LB	
AMC4QD	AHKQ1
AMC6QD	
FCS, FCV, FCN, FCH or FCL	AHKFD1
FGV, FGN, FGH or FGP	AHKFG1

### Mounting Hardware—Hardware only; no brackets or straps Bolt-On Spectra™

Breaker Frame	Product Number
SE	AHKBE1
SF	AHKBF1
SG	AHKBG1
THQD	AHKBQ1
FCS, FCV, FCN, FCH or FCL	AHKbfd1
FGV, FGN, FGH or FGP	AHKbfg1
FB	AHKbfb1



# Panelboards Spectra™ Series Panelboards Renewal Parts

Main Lug Modules; Neutral and Ground Kits  
Plug-In or Bolt-On

## Lug Kits and Modules Plug-In Spectra™

- FP suffix indicates all AFPML cover plates included to fit applicable box widths.
- Can be converted to dual main lug version by adding lug kits (see Accessories).
- Mechanical lug modules can be converted to compression lug modules by replacing standard lugs with AMKP compression lug kit (see Accessories)
- Can be used for feed-thru lugs application by replacing standard cover plate with AFL feed-thru lug cover plate kit (see Accessories).

Lug Ampere Rating	Lug Type	X Height	Lugs Per Phase	Wires per Lug	Wire Range (Cu/Al)	Included Cover Plate	Box Width Range	Product Number
250	Mechanical	4X	1	1	#6-350kcmil	AFPML4X	27",36"	AML3250SFP <sup>1</sup>
250	Mechanical	6X	1	1	#6-350kcmil	AFPML6X	36"	AML3250FP
400	Mechanical	4X	1	2	#2-500kcmil	AFPML4X	27",36",44"	AML3400SFP <sup>1</sup>
400	Mechanical	6X	1	2	#2-500kcmil	AFPML6X	36",44"	AML3400FP
600	Mechanical	4X	1	2	#2-500kcmil	AFPML4X	27",36",44"	AML3600SFP <sup>1</sup>
600	Mechanical	6X	1	2	#2-500kcmil	AFPML6X	36",44"	AML3600FP
800	Mechanical	6X	2	2	#2-500kcmil	AFPML6XW	36",44"	AML3800FP
1200	Mechanical	6X	2	2	#2-500kcmil	AFPML6XW	36",44"	AML3120FP
250	Compression	6X	2	1	350kcmil	AFPML6X	36"	AML3250CFP
400	Compression	6X	2	1	500kcmil	AFPML6X	36",44"	AML3400CFP
600	Compression	6X	2	1	500kcmil	AFPML6X	36",44"	AML3600CFP
800	Compression	6X	4	1	500kcmil	AFPML6XW	36",44"	AML3800CFP
1200	Compression	6X	4	1	500kcmil	AFPML6XW	36",44"	AML3120CFP

<sup>1</sup>4X modules cannot be converted to compression lug version.

## Lug Kits and Modules Plug-In or Bolt-On Spectra™—Neutral

- Includes mechanical lugs and bonding strap.
- 250 to 600A neutral kits can be converted to dual main version by doubling the main lug quantity using lug kits (see Accessories).
- Main lug on neutral kit can be converted to compression main using AMKP lug kit.

Lug Amp Rating	No. of Main Lugs	No. of Wires	Wire Range (Cu/Al)	Product Number
<b>Bolt-On</b>				
250/400	Single/Dual	2 (MAIN)	#2 - 600kcmil	ANKN400
		16	#14 - 2/0	
		5	#6 - 300kcmil	
		24	#14 - #4	
600/800/1200	Single/Dual	8 (MAIN)	#2 - 600kcmil	ANKN120
		9	#14 - 2/0	
		10	#6 - 300kcmil	
		10	#14 - #4	
<b>Plug-In</b>				
800	Dual	8 (MAIN)	#2 - 500kcmil	ANK800D
		8	#14 - 2/0	
		10	#6 - 300kcmil	
		4	#2 - 500kcmil	
1200	Dual	8 (MAIN)	#2 - 500kcmil	ANK120D
		8	#14 - 2/0	
		10	#6 - 300kcmil	
		4	#2 - 500kcmil	

For 3ph, 4W single-section panelboards, use a standard neutral.

For 3ph, 4W multi-section panelboards, use a standard neutral on the last section, and a dual main neutral on the first and middle sections.

## Lug Kits and Modules Plug-In or Bolt-On Spectra™—Ground

- AEG10 and AEG21 should be ordered in multiples of 10 due to 10 kits per carton bulk-packaging.
- AEG21S and AEG31S are packaged as quantity 1 kit per carton.

Bonding Type	Total Circuits	No. of Wires	Wire Range (Cu/Al)	Product Number
Bonded	10	10	#6-2/0 Cu/Al	AEG10
Bonded	21	9	Solid: #14-#8 Cu or #12-#8 Al or Stranded: #12-#8 Cu or #12-#8 Al or Stranded: #10-#4 Cu or #10-#4 Al	AEG21
Insulated/Isolated	21	9	Solid: #14-#8 Cu or #12-#8 Al or Stranded: #12-#8 Cu or #12-#8 Al or Stranded: #10-#4 Cu or #10-#4 Al	AEG21S
Insulated/Isolated	31	10	#6-2/0 Cu/Al	AEG31S



**Feed Thru Lug Cover Plate Kits**

- Use to convert AML main lug module to feed thru lug module
- Kit includes barrier and oversized cover plates.  
 (Discard original cover plates.)

Lug Amp Rating	X Height	Box Width Range	Product Number
250/400/600	9X	27", 36", 44"	AFL600
800/1200	12X	36", 44"	AFL120

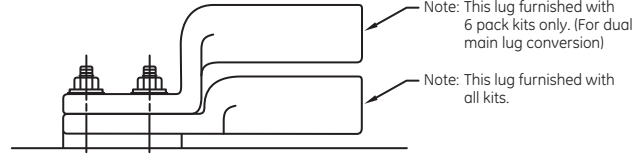

**Crimp Lugs**

**Mechanical Lug Kits and Modules**

- Use to convert AML main mechanical lug modules or ANK neutral modules to dual main lug version.
- Can be used to replace standard lugs with oversized lugs.

Wire Range (Cu/Al)	Lugs Per Kit	Wires per Lug	Product Number
#6-350kcmil	3	1	AMK350
#2-500kcmil	3	2	AMK500
#2-600kcmil	3	2	AMK600
3/0-750kcmil	3	2	AMK750

**Compression Lug Kits**

- Use to replace standard load-side mechanical lugs on ADS branch switches.
- Each kit includes 3 lugs.

Wire Range	Lugs Per Phase	For Switch Amperes	Product Number
#8-1/0 Cu/Al	1	30, 60, or 100	KLP101
#4-300kcmil Cu/Al	1	200	KLP300
2/0-500kcmil Cu/Al	2, 4	800 or 1200	KLP500
400-500kcmil Cu or 400-600kcmil Al	2, 4	800 or 1200	KLP600
500-750kcmil Cu/Al	2, 4	800 or 1200	KLP750

**Compression Lug Kits and Modules**

Use to convert AML main mechanical lug modules to compression lug version.

Wire Size	Package Type	Crimp Tool Die Cat. No. Homac	Crimp Tool Die Cat. No. Burndy	Crimp Tool Die Cat. No. T&B	Product Number
1/0	3 PACK	15CA52	296	50	AMKP101
1/0	6 PACK	15CA52	296	50	AMKP2101
2/0	3 PACK	15CA52	297	54H	AMKP202
2/0	6 PACK	15CA52	297	54H	AMKP2202
3/0	3 PACK	15CA66	467	60	AMKP303
3/0	6 PACK	15CA66	467	60	AMKP2303
4/0	3 PACK	15CA71H	298	66	AMKP404
4/0	6 PACK	15CA71H	298	66	AMKP2404
250kcmil	3 PACK	15CA76	324	71H	AMKP250
250kcmil	6 PACK	15CA76	324	71H	AMKP2250
300kcmil	3 PACK	15CA87H 15C87	470	76	AMKP300
300kcmil	6 PACK	15CA87H 15C87	470	76	AMKP2300
350kcmil	3 PACK	15CA96H 15C96H	299	87H	AMKP350
350kcmil	6 PACK	15CA96H 15C96H	299	87H	AMKP2350
400kcmil	3 PACK	15CA96H 15C96H	472	94H	AMKP400
400kcmil	6 PACK	15CA96H 15C96H	472	94H	AMKP2400
500kcmil	3 PACK	15CA106A 15C106R	300	99H	AMKP500
500kcmil	6 PACK	15CA106A 15C106R	300	99H	AMKP2500
600kcmil	3 PACK	15CA115H 15C115H	473	106H	AMKP600
600kcmil	6 PACK	15CA115H 15C115H	473	106H	AMKP2600
700/750 kcmil	3 PACK	15C125H	936	115H	AMKP750
700/750 kcmil	6 PACK	15C125H	936	115H	AMKP2750

Notes: For dual main applications, double the kit quantity.

**Permanent Circuit Number Tabs**

For Circuit Numbers	Product Number
1-49	APN49
1-99	APN99



# Panelboards Spectra™ Series Panelboards Merchandise

Renewal Parts

Interiors, Boxes and Fronts

Order from Customer Service Center

## Section 11

### Product Features

- In selecting an interior X-height, add up all required main and branch module X-heights, plus any required spaces for future.
- UL Service Entrance label is included on all interiors.

### Boxes

Panel Current Rating (amperes)	Space X Height	Box Width/Depth	Box Height (inches)	Product Number
250, 400	18	27" W x 14.5" D	64.63	APB2765A
250	28	27" W x 14.5" D	64.63	APB2765C
250, 400, 600	38	27" W x 14.5" D	89.25	APB2789
400	28	27" W x 14.5" D	75.5	APB2775
600	23	27" W x 14.5" D	64.63	APB2765B
250, 400, 600	18, 28	36" W x 11.5" D	64.63	APB3665
400, 800, 1200	28	36" W x 11.5" D	75.5	APB3675
250, 400, 600, 800, 1200	38	36" W x 11.5" D	89.25	APB3689
250, 400, 600, 800, 1200	43, 48	36" W x 11.5" D	96.13	APB3696
400, 600	18, 23	44" W x 11.5" D	64.63	APB4465
400, 800, 1200	23, 28	44" W x 11.5" D	75.5	APB4475
400, 600, 800, 1200	38	44" W x 11.5" D	89.25	APB4489
400, 600, 800, 1200	43, 48	44" W x 11.5" D	96.13	APB4496

### Front w/Door

Panel Current Rating (amperes)	Space X Height	Box Width/Depth	Box Height (inches)	Product Number
250	18	27" W x 14.5" D	64.63	APF6518NS
250	28	27" W x 14.5" D	64.63	APF6528NS
250	38	27" W x 14.5" D	89.25	APF8938NS
400	18	27" W x 14.5" D	64.63	APF6518S
400	28	27" W x 14.5" D	75.5	APF7528S
600	23	27" W x 14.5" D	64.63	APF6523S
600	38	27" W x 14.5" D	89.25	APF8938S

### 4-pc Fronts

Panel Current Rating (amperes)	Space X Height	Box Width/Depth	Box Height (inches)	Product Number
250	18	36" W x 11.5" D	64.63	APF6518N
250	28	36" W x 11.5" D	64.63	APF6528N
250	38	36" W x 11.5" D	89.25	APF8938N
250	53	36" W x 11.5" D	96.13	APF9653N
400	18	36" W x 11.5" D	64.63	APF6518
400, 800, 1200	28	36" W x 11.5" D	75.5	APF7528
400, 600, 800, 1200	38	36" W x 11.5" D	89.25	APF8938
600	23	36" W x 11.5" D	64.63	APF6523
400, 600, 800, 1200	48	36" W x 11.5" D	96.13	APF9648
800	23	36" W x 11.5" D	75.5	APF7523
800, 1200	43	36" W x 11.5" D	96.13	APF9643
400	18	44" W x 11.5" D	64.63	APF6518W
600	23	44" W x 11.5" D	64.63	APF6523W
800	23	44" W x 11.5" D	75.5	APF7523W
400, 1200	28	44" W x 11.5" D	75.5	APF7528W
400, 600, 800, 1200	38	44" W x 11.5" D	89.25	APF8938W
800, 1200	43	44" W x 11.5" D	96.13	APF9643W
400, 600	48	44" W x 11.5" D	96.13	APF9648W

### Interior Aluminum

Panel Current Rating (amperes)	Space X Height	Product Number
250	18	APN1802U
250	28	APN2802U
250	38	APN3802U
250	53	APN5302U
400	18	APN1804U
400	28	APN2804U
400	38	APN3804U
400	48	APN4804U
600	23	APN2306U
600	38	APN3806U
600	48	APN4806U
800	23	APN2308U
800	38	APN3808U
800	43	APN4308U
1200	28	APN2812U
1200	38	APN3812U
1200	43	APN4312U

### Interior Copper

Panel Current Rating (amperes)	Space X Height	Product Number
250	18	APN1802UB4
250	28	APN2802UB4
250	38	APN3802UB4
250	53	APN5302UB4
400	18	APN1804UB4
400	28	APN2804UB4
400	38	APN3804UB4
400	48	APN4804UB4
600	23	APN2306UB4
600	38	APN3806UB4
600	48	APN4806UB4
800	23	APN2308UB4
800	38	APN3808UB4
800	43	APN4308UB4
1200	28	APN2812UB4
1200	38	APN3812UB4
1200	43	APN4312UB4



# Panelboards Spectra™ Series Panelboards Type SCP Plus

# Section 11

## Renewal Parts

Enclosure Options, Mounting Hardware and Spare Parts

Order through the Customer Service Center unless stated otherwise below.

### Boxes

Box Width/Depth	X Height	Box Height (inches)	Product Number
31"W x 11.5"D	15	49.375	ACB311149
31"W x 11.5"D	18	53.5	ACB311153
31"W x 11.5"D	21	57.625	ACB311157
31"W x 11.5"D	24	61.75	ACB311161
31"W x 11.5"D	27	65.875	ACB311165
31"W x 11.5"D	30	70	ACB311170
31"W x 11.5"D	33	74.125	ACB311174
31"W x 11.5"D	36	78.25	ACB311178
31"W x 11.5"D	39	82.275	ACB311182
31"W x 11.5"D	42	86.5	ACB311186
40"W x 11.5"D	15	49.375	ACB401149
40"W x 11.5"D	18	53.5	ACB401153
40"W x 11.5"D	21	57.625	ACB401157
40"W x 11.5"D	24	61.75	ACB401161
40"W x 11.5"D	27	65.875	ACB401165
40"W x 11.5"D	30	70	ACB401170
40"W x 11.5"D	33	74.125	ACB401174
40"W x 11.5"D	36	78.25	ACB401178
40"W x 11.5"D	39	82.275	ACB401182
40"W x 11.5"D	42	86.5	ACB401186

Box dimensions are inside dimensions. Add 1/4-inch for outside dimensions.  
Boxes furnished with no knockouts.

### Fronts

Box Width/Depth	X Height	Box Height (inches)	Product Number
31"W x 11.5"D	15	49.375	ACF3149S
31"W x 11.5"D	18	53.5	ACF3153S
31"W x 11.5"D	21	57.625	ACF3157S
31"W x 11.5"D	24	61.75	ACF3161S
31"W x 11.5"D	27	65.875	ACF3165S
31"W x 11.5"D	30	70	ACF3170S
31"W x 11.5"D	33	74.125	ACF3174S
31"W x 11.5"D	36	78.25	ACF3178S
31"W x 11.5"D	39	82.275	ACF3182S
31"W x 11.5"D	42	86.5	ACF3186S
40"W x 11.5"D	15	49.375	ACF4049S
40"W x 11.5"D	18	53.5	ACF4053S
40"W x 11.5"D	21	57.625	ACF4057S
40"W x 11.5"D	24	61.75	ACF4061S
40"W x 11.5"D	27	65.875	ACF4065S
40"W x 11.5"D	30	70	ACF4070S
40"W x 11.5"D	33	74.125	ACF4074S
40"W x 11.5"D	36	78.25	ACF4078S
40"W x 11.5"D	39	82.275	ACF4082S
40"W x 11.5"D	42	86.5	ACF4086S

Flush fronts (F) are 2 inches larger than box. Surface fronts (S) are 1/4-inch larger than box.

Note: If filler plates for SCP+ panels are required, please contact Houston equipment plant.

Note: THLC 1/2/4 breaker no longer available.

### Mounting Hardware—Hardware Kit and Straps

Mounting Arrangement	Breaker Frame	Maximum Breaker Amperage	Breaker Number of Poles	Product Number
Dual Mounted	SHE, SEL, SED, SEP	150A		ACTMKSE
Dual Mounted	TEB, TED, THED	150A	single-pole	ACTMKEB1P
Dual Mounted	TEB, TED, THED	150A	two-pole	ACTMKEB2P
Dual Mounted	TEB, TED, THED	150A	three-pole	ACTMKEB3P
Dual Mounted	TFK, SFH, SFL, SFP	250A		ACTMKSF
Dual Mounted	TQD, THQD	225A	two-pole	ACTMKQD2P
Dual Mounted	TQD, THQD	225A	three-pole	ACTMKQD3P
Dual Mounted	TJD, TJJ, TJK	400A		ACTMKJD
Dual Mounted	SGD, SGH, SGL, SGP	400A, 600A		ACTMKSG
Single Mounted	SGD, SGH, SGL, SGP	400A, 800A		ACSMKSG
Single Mounted	SKH, SKL	800A, 1200A		ACSMKSK
Single Mounted	TB4	400A		ACSMKTB4
Single Mounted	TB6	600A		ACSMKTB6
Single Mounted	TB8	800A		ACSMKTB8

### Mounting Hardware—Filler Plate and Filler Hardware

Mounting Arrangement	Breaker Frame	Maximum Breaker Amperage	Breaker Number of Poles	Product Number
Dual Mounted	SHE, SEL, SED, SEP	150A		ACTFPKSE
Dual Mounted	TEB, TED, THED	150A	single-pole	ACTFPKEB1P
Dual Mounted	TEB, TED, THED	150A	two-pole	ACTFPKEB2P
Dual Mounted	TEB, TED, THED	150A	three-pole	ACTFPKEB3P
Dual Mounted	TFK, SFH, SFL, SFP	250A		ACTFPKSF
Dual Mounted	TQD, THQD	225A	two-pole	ACTFPKQD2P
Dual Mounted	TQD, THQD	225A	three-pole	ACTFPKQD3P
Dual Mounted	TJD, TJJ, TJK	400A		ACTFPKJD
Dual Mounted	SGD, SGH, SGL, SGP	400A, 600A		ACTFPKSG
Single Mounted	SGD, SGH, SGL, SGP	400A, 800A		ACSFPKSG
Single Mounted	SKH, SKL	800A, 1200A		ACSFPKSK
Single Mounted	TB4	400A		ACSFPKTB4

### Mounting Hardware—Hardware to Mount One Breaker

Mounting Arrangement	Breaker Frame	Maximum Breaker Amperage	Breaker Number of Poles	Product Number
Dual Mounted	SHE, SEL, SED, SEP	150A		ACTHKSE
Dual Mounted	TEB, TED, THED	150A	single-pole	ACTHKEB1P
Dual Mounted	TEB, TED, THED	150A	two-pole	ACTHKEB2P
Dual Mounted	TEB, TED, THED	150A	three-pole	ACTHKEB3P
Dual Mounted	TFK, SFH, SFL, SFP	250A		ACTHKSF
Dual Mounted	TQD, THQD	225A	two-pole	ACTHKQD2P
Dual Mounted	TQD, THQD	225A	three-pole	ACTHKQD3P
Dual Mounted	TJD, TJJ, TJK	400A		ACTHKJD
Dual Mounted	SGD, SGH, SGL, SGP	400A, 600A		ACTHKSG
Single Mounted	SGD, SGH, SGL, SGP	400A, 800A		ACSHKSG
Single Mounted	SKH, SKL	800A, 1200A		ACSHKSK
Single Mounted	TB4	400A		ACSHKTB4





# Panelboards Spectra™ Series Panelboards Power

### Renewal Parts

Type [CCB](#) and [QMR](#) Panelboards

Order through the Customer Service Center unless stated otherwise below.

### Mounting Hardware—Copper Straps for Use on Cu or Al Main Bus Dual Mounted

Breaker Frame	Kit Ampere Rating	Product Number
TEB/TED	150A	TED1DPK
TEJ/TFK/TFL	225A	TF2DPK
TQD	225A	TQ2DPK
TJD/TJJ/TJK	400A	TJ4DPK
TJK	600A	TJ6DPK
TLB1/THLC1	150A	THLC1DPK
TEL	150A	TEL1DPK
TB1	150A	TB1DPK
SFH/SFL	225A	SF2DPK <sup>1,2</sup>

<sup>1</sup>If mounting hardware exists – must order SFCARE for additional insulators.

<sup>2</sup>225A Maximum

### Mounting Hardware—Copper Straps for Use on Cu or Al Main Bus Single Mounted

Breaker Frame	Kit Ampere Rating	Product Number
TKM8/THKM8	800A	TK8SPK <sup>3</sup>
TB1	100A	TB1SPK <sup>3</sup>
TB6	600A	TB6SPK <sup>3</sup>
TB8	800A	TB8SPK <sup>3</sup>
TKM12/THKM12	1200A	TK12SPK <sup>3,4</sup>
SKH8	800A	SK8SPK <sup>3</sup>
SKH12	1200A	SK12SPK <sup>3</sup>

<sup>3</sup>Deep mounted interior is required.

<sup>4</sup>Requires 7x of space if mounted at extreme end (top or bottom) of interior or 8x if mounted in center of interior.

### Device and Hardware Suffix Selection

Panelboard Lighting Type	Device Type		
	Twin (Double) Mount	Single Mount	TQD, TED, Panel Subfeed
CCB/QMR	DPK	SPK	—
Switchboards	DPK	SPK	—

To ensure a unit shipment, you must order using the device product number plus suffix; orders for the device and kit as separate items will ship as separate items.



# Panelboards

## Spectra™ Series Panelboards

### Power

## Section 11

#### Renewal Parts

#### Type CCB and QMR Panelboards

Order through the Customer Service Center unless stated otherwise below.

#### Replacement Panelboard CCB Front (Flush or Surface)

Box Width/Depth	X Height	Box Height (inches)	Product Number <sup>1</sup>
31" Wide x 9 1/2" Deep Box (No Knockouts)	15X	49	CBA3121S,F
31" Wide x 9 1/2" Deep Box (No Knockouts)	18X	53 1/2	CBA3124S,F
31" Wide x 9 1/2" Deep Box (No Knockouts)	21X	57 5/8	CBA3127S,F
31" Wide x 9 1/2" Deep Box (No Knockouts)	24X	61 3/4	CBA3130S,F
31" Wide x 9 1/2" Deep Box (No Knockouts)	30X	70	CBA3136S,F
31" Wide x 9 1/2" Deep Box (No Knockouts)	42X	86 1/2	CBA3148S,F
35" Wide x 11 1/2" Deep Box (No Knockouts)	36X	78 1/4	CBA3542S,F
40" Wide x 11 1/2" Deep Box (No Knockouts)	21X	57 5/8	CBA4027S,F
40" Wide x 11 1/2" Deep Box (No Knockouts)	24X	61 3/4	CBA4030S,F
40" Wide x 11 1/2" Deep Box (No Knockouts)	30X	70	CBA4036S,F
40" Wide x 11 1/2" Deep Box (No Knockouts)	33X	74 1/8	CBA4039S,F
40" Wide x 11 1/2" Deep Box (No Knockouts)	36X	78 1/4	CBA4042S,F
40" Wide x 11 1/2" Deep Box (No Knockouts)	39X	82 3/8	CBA4045S,F

<sup>1</sup>Flush fronts (F) are 2 inches larger than box. Surface fronts (S) are 1/4-inch larger than box.

#### Replacement Panelboard CCB Box

Box Width/Depth	X Height	Box Height (inches)	Product Number
31" Wide x 9 1/2" Deep Box (No Knockouts)	15X	49	DASW3121
31" Wide x 9 1/2" Deep Box (No Knockouts)	21X	57 5/8	DASW3127
31" Wide x 9 1/2" Deep Box (No Knockouts)	24X	61 3/4	DASW3130
31" Wide x 9 1/2" Deep Box (No Knockouts)	27X	65 7/8	DASW3133
31" Wide x 9 1/2" Deep Box (No Knockouts)	30X	70	DASW3136
31" Wide x 9 1/2" Deep Box (No Knockouts)	36X	78 1/4	DASW3142
35" Wide x 11 1/2" Deep Box (No Knockouts)	33X	74 1/8	DACB3539
35" Wide x 11 1/2" Deep Box (No Knockouts)	39X	82 3/8	DACB3545
40" Wide x 11 1/2" Deep Box (No Knockouts)	21X	57 5/8	DACB4027
40" Wide x 11 1/2" Deep Box (No Knockouts)	24X	61 3/4	DACB4030
40" Wide x 11 1/2" Deep Box (No Knockouts)	27X	65 7/8	DACB4033
40" Wide x 11 1/2" Deep Box (No Knockouts)	30X	70	DACB4036
40" Wide x 11 1/2" Deep Box (No Knockouts)	33X	74 1/8	DACB4039
40" Wide x 11 1/2" Deep Box (No Knockouts)	36X	78 1/4	DACB4042
40" Wide x 11 1/2" Deep Box (No Knockouts)	39X	82 3/8	DACB4045
40" Wide x 11 1/2" Deep Box (No Knockouts)	42X	86 1/2	DACB4048

Note: Box dimensions are inside dimensions. Add 1/4-inch for outside dimensions.  
Boxes furnished without knockouts as standard.

#### Filler Plates

Panel Type	X Height	Product Number
QMR	1X	QMRFP1
QMR	2X	QMRFP2
QMR	5X	QMRFP5
QMR	3X	75C145005G703
CCB	1X	CCBFP1
CCB	3X	CCBFP3
CCB	5X	CCBFP5
CCB	2X	75C145005G711
CCB	6X	75C145005G715
SCP+	1X	SCPPFP1
SCP+	2X	SCPPFP2
SCP+	3X	SCPPFP3
SCP+	5X	SCPPFP5

(Order from Local Sales Office or Equipment Plant)



# Panelboards

## Spectra™ Series Panelboards

### Power

#### Renewal Parts

Type [CCB](#) and [QMR](#) Panelboards

Order through the Customer Service Center unless stated otherwise below.

#### QMR Fusible Switch 240V<sup>1, 2</sup>

Switch Amps	Number of Poles	Description	Product Number
30	3	Left Hand Unit	THFP321L
30	3	Right Hand Unit - 3X	THFP321X
60	3	Right Hand Unit	THFP322
60	3	Left Hand Unit	THFP322L
60	3	Right Hand Unit - 3X	THFP322X
60	3	Left Hand Unit - 3X	THFP322XL
100	3	Right Hand Unit	THFP323
100	3	Left Hand Unit	THFP323L
200	3	Center Mount	THFP324
400	3	Center Mount	THFP325
600	3	Center Mount	THFP326

<sup>1</sup>Limited availability. Obsolete when inventory depleted.

<sup>2</sup>Switch and mounting hardware kit must be ordered separately

#### QMR Mounting Hardware Kits Are Copper for Use with Cu or Al Main Bus Dual Mounted

Breaker Frame	Kit Ampere Rating	Voltage	Product Number
THFP	30-60A	240 & 600V	THFP62DPK
THFP	100A	600V	THFP63DPKJ
THFP	100A	240 & 600V	THFP63DPK
THFP	100-30/60	600V	THFP63DPKC

Note: QMR Power Panelboards 600V, 100A double branch units require a minimum width of 40". 600V, 30A and 60A double branch, and 240V, 30A, 60A and 100A single and double branch units can be built in a 35" wide enclosure.

#### QMR Mounting Hardware Kits Are Copper for Use with Cu or Al Main Bus Single Mounted

Breaker Frame	Kit Ampere Rating	Voltage	Product Number
THFP	30/60A	240V	THFP22SPK
THFP	30/60/100A	240V & 600V	THFP62SPK
THFP	100A	600V	THFP63SPK
THFP	200A	240 & 600V	THFP64SPK
THFP	400A	240 & 600V	THFP65SPK
THFP	600A	240 & 600V	THFP66SPK
THFP	1200A	240 & 600V	THFP67SPK

Note: QMR Power Panelboards 600V, 100A double branch units require a minimum width of 40". 600V, 30A and 60A double branch, and 240V, 30A, 60A and 100A single and double branch units can be built in a 35" wide enclosure.

#### QMR Fusible Switch 600V<sup>1, 2</sup>

Switch Amps	Number of Poles	Description	Product Number
30	3	Right Hand Unit	THFP361
30	3	Left Hand Unit	THFP361L
60	3	Right Hand Unit	THFP362
60	3	Left Hand Unit	THFP362L
100	3	Right Hand Unit	THFP363
100	3	Left Hand Unit	THFP363L
200	3	Center Mount	THFP364
400	3	Center Mount	THFP365
600	3	Center Mount	THFP366
800	3	Center Mount	THFP367
1200	3	Center Mount	THFP368

#### Maximum Horsepower Ratings QMR Fusible Switch

Rating in Amperes <sup>3</sup>	Vac						Vdc		
	2-Pole				3-Pole			2-Pole 3-Pole	
	120	240	480	600	240	480	600	125	250
<b>With Standard and Fuses (Class H)</b>									
30	1/2	1 1/2	3	3	3	5	7 1/2	2	5
60	1 1/2	3	5	10	7 1/2	15	15	5	10
100	—	7 1/2	10	15	15	25	30	—	20
200	—	15	25	30	25	50	60	—	40
400	—	—	—	—	50	100	125	—	—
600	—	—	—	—	75	150	200	—	—
<b>With "Time-delay" Fuses (Class H)</b>									
30	2	5	10	15	10	20	20	3	—
60	3	10	20	25	20	40	50	5	—
100	—	15	30	40	30	60	75	—	—
200	—	30	50	50	60	125	150	—	—
400	—	—	—	—	125	250	350	—	—
600	—	—	—	—	200	400	500	—	—

<sup>3</sup>Ratings are based on latest revision of the National Electric Code Article 430. Horsepower ratings for switches with standard class H fuses are based on one-time fuses having minimum time-delay. When time-delay fuses are used the horsepower ratings are maximum for the switches.

#### QMR Fusible Switch Terminations<sup>4</sup>

Switch Amperes	Voltage	Wire Range (Cu/Al)	Wires per Lug	Lugs per Phase
30	250/600	#14-10	1	1
60	250/600	#14-2	1	1
100	250/600	#10-1/0	1	1
200	250/600	#6-250kcmil or 2(I/O-250kcmil)	1	1
400	250/600	#6-250kcmil or 2(I/O-250kcmil)	1	1
600	250/600	250-350kcmil Cu or 350-500kcmil Al	2	2
800	250/600	#4-600kcmil	1	4
1000	250/600	#4-600kcmil	1	4

<sup>4</sup>For optional lugs refer to GEH-460B



## Available Publications

### Spectra™ Series Power Panels Plug-In and Bolt-On

Circuit Breaker Mounting Instructions (Modules)	
TKM, THKM, TK4V, TKL4V, SKHA, SKLA, SKPA	GEH-5623
TJK, TJD, TJJ, THJK, TJ4V, THJ4V, TJL4V	GEH-5624
TEB, TED, THED, TEL, SEDA, SEHA, SELA, SEPA	GEH-5625
TFJ, TFK, THFK, TFL, SFHA, SFLA, SEPA	GEH-5626
TQD, THQD	GEH-5643
THLC1	GEH-5644
SGDA, SGHA, SGLA, SGPA (3 pole)	GEH-5673
SGDA, SGHA, SGLA, SGPA (2 pole)	GEH-5674
THLC2, THLC4, TLB4 (3 pole)	GEH-5675
THLC2, THLC4, TLB4 (2 pole)	GEH-5676
TEY, THQB, THQB	GEH-5677
Circuit Breaker Mounting Hardware Kits	
TQD, THQD, SE TEB, TED, THED, THLC1, SF, TFJ, TFK, THFK, SG, TJK, THJK, TJD, TJJ, THLC2, THLC4	GEH-5913
Installing Lugs	
Type AML Main Lug Kits	GEH-5588
Type AML Feed Thru Main Lug Kits	GEH-5630
Installing Fusible Switches	
Fuse Pullers	DEH-034
Class R Fuse Rejector Kit	GEH-4616
R Fuse Rejection Pin, 400-600 Ampere Switch Units	GEH-5577
Lug Kits into GE Type ADS Switches	GEH-5944
Alternate Lugs, 30-1200 Ampere Fusible Switch Units	GEJ-3050
Installing Fusible Switch Expansion Kits	
30/60 Ampere Expansion Kit	GEH-5547
60A, 100A Expansion Kits for Type ADS Fusible Switch Units	GEH-5581
200 Ampere Expansion Kit (J, T Fuses)	GEH-5582
200 Ampere Expansion Kit (H, K, R Fuses)	GEH-5889
Handle and Load Base Replacements on Fusible Switches	
Handle Replacement: 400-1200 Ampere Switches	GEH-5553
Load Base Replacement for Type ADS 400-600 Ampere Switches	GEH-5576
Miscellaneous	
Typical - Fusible Mains and Feeders	DE-166
Technical Data, Spectra Series Panelboards - Pressure Locked Connectors	DE-168

### Spectra™ Series Plug-In (Only)

Circuit Breaker Mounting Instructions (Modules)	
TKM, THKM, TK4V, LA, SKPA	GEH-5623
TJK, TJD, TJJ, THJK, TJ4V, THJ4V, TJL4V	GEH-5624
TEB, TED, THED, TEL, SEDA, SEHA, SELA, SEPA	GEH-5625
TFJ, TFK, THFK, TFL, SFHA, SFLA, SEPA	GEH-5626
TQD, THQD	GEH-5643
SGDA, SGHA, SGLA, SGPA (3 pole)	GEH-5673
SGDA, SGHA, SGLA, SGPA (2 pole)	GEH-5674
THLC2, THLC4, TLB4 (3 pole)	GEH-5675
Circuit Breaker Mounting Hardware Kits	
TQD, THQD, SE TEB, TED, THED, THLC1, SF, TFJ, TFK, THFK, SG, TJK, THJK, TJD, TJJ, THLC2, THLC4	GEH-5913
Installing Lugs	
Type AML Main Lug Kits	GEH-5588
Type AML Feed Thru Main Lug Kits	GEH-5630

### Spectra™ Series Plug-In (Only) (continued)

Installing Fusible Switches	
Fuse Pullers	DEH-034
Class R Fuse Rejector Kit	GEH-4616
R Fuse Rejection Pin, 400-600 Ampere Switch Units	GEH-5577
Lug Kits into GE Type ADS Switches	GEH-5944
Alternate Lugs, 30-1200 Ampere Fusible Switch Units	GEJ-3050
Installing Fusible Switch Expansion Kits	
30/60 Ampere Expansion Kit	GEH-5547
60A, 100A Expansion Kits for Type ADS Fusible Switch Units	GEH-5581
200 Ampere Expansion Kit (J, T Fuses)	GEH-5582
200 Ampere Expansion Kit (H, K, R Fuses)	GEH-5889
Handle and Load Base Replacements on Fusible Switches	
Handle Replacement: 400-1200 Ampere Switches	GEH-5553
Load Base Replacement for Type ADS 400-600 Ampere Switches	GEH-5576
Miscellaneous	
Typical - Fusible Mains and Feeders	DE-166
Technical Data, Spectra Series Panelboards - Pressure Locked Connectors	DE-168

### Spectra™ Series Bolt-On (Only)

Circuit Breaker Mounting Instructions (Straps)	
TEB, TED, THED, SED, SEH, SEL, SEP	DEH-047
SGH, SFL, SFP	DEH-059
SGH, SGL, SGP	DEH-060
SKH, SKL, SKP, TKM, THKM	DEH-061
TEY	DEH-062
TQD, THQD	DEH-065

### A-Series™ Panelboards

Lighting Panel Rating Labels	DEH-40007
GE Panelboards	DEA-185
Stainless Steel Enclosures	DET-386
AD Plus Lighting Panelboards	DEP-131
UL Recognized Series Connected Ratings	DET-008

### A-Series™ Lighting Control Panel

Lighting Control Panel Catalog/Selection Guide	DEA-388
Fact Sheet	DET-398

### Pro-Stock Panelboard

Selection and Pricing Guide	DEP-104A
Fact Sheet	DET-233
Product Summary	DEE-240
Initial Stock Order Form	DEZ-176
Branch Breaker Recommended Stock List	DEE-241
Pro-Stock Literature Order Form	DEZ-178
Sell Sheet	DEA-232
New Product Commercialization Summary	DEE-240
Q & A	DEQ-068

