

## FEATURES

- 12 MHz multiplying bandwidth
- INL of  $\pm 0.25$  LSB at 8-bit
- 8-lead TSOT and MSOP packages
- 2.5 V to 5.5 V supply operation
- Pin-compatible 8-/10-/12-/14-bit current output DACs
- $\pm 10$  V reference input
- 50 MHz serial interface
- 2.7 MSPS update rate
- Extended temperature range:  $-40^{\circ}\text{C}$  to  $+125^{\circ}\text{C}$
- 4-quadrant multiplication
- Power-on reset with brownout detect
- $< 0.4$   $\mu\text{A}$  typical current consumption
- Guaranteed monotonic
- Qualified for automotive applications

## APPLICATIONS

- Portable battery-powered applications
- Waveform generators
- Analog processing
- Instrumentation applications
- Programmable amplifiers and attenuators
- Digitally controlled calibration
- Programmable filters and oscillators
- Composite video
- Ultrasound
- Gain, offset, and voltage trimming

## GENERAL DESCRIPTION

The AD5450/AD5451/AD5452/AD5453<sup>1</sup> are CMOS 8-/10-/12-/14-bit current output digital-to-analog converters, respectively. These devices operate from a 2.5 V to 5.5 V power supply, making them suited to several applications, including battery-powered applications.

As a result of manufacture on a CMOS submicron process, these DACs offer excellent 4-quadrant multiplication characteristics of up to 12 MHz.

These DACs use a double-buffered, 3-wire serial interface that is compatible with SPI®, QSPI™, MICROWIRE™, and most DSP interface standards. Upon power-up, the internal shift register and latches are filled with 0s, and the DAC output is at zero scale.

<sup>1</sup> U.S. Patent Number 5,689,257.

### Rev. G

### Document Feedback

Information furnished by Analog Devices is believed to be accurate and reliable. However, no responsibility is assumed by Analog Devices for its use, nor for any infringements of patents or other rights of third parties that may result from its use. Specifications subject to change without notice. No license is granted by implication or otherwise under any patent or patent rights of Analog Devices. Trademarks and registered trademarks are the property of their respective owners.

## FUNCTIONAL BLOCK DIAGRAM

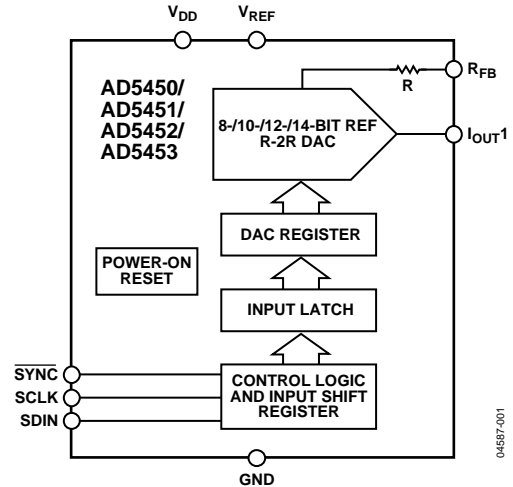

Figure 1.

The applied external reference input voltage ( $V_{REF}$ ) determines the full-scale output current. These parts can handle  $\pm 10$  V inputs on the reference, despite operating from a single-supply power supply of 2.5 V to 5.5 V. An integrated feedback resistor ( $R_{FB}$ ) provides temperature tracking and full-scale voltage output when combined with an external current-to-voltage precision amplifier.

The AD5450/AD5451/AD5452/AD5453 DACs are available in small 8-lead TSOT, and the AD5452/AD5453 are also available in MSOP packages. The AD5453 also comes in 8-lead LFCSP.

The EV-AD5443/46/53SDZ evaluation board is available for evaluating DAC performance. For more information, see the [UG-327](#) evaluation board user guide.

## TABLE OF CONTENTS

Features .....	1	DAC Section.....	16
Applications.....	1	Circuit Operation .....	16
Functional Block Diagram .....	1	Single-Supply Applications .....	18
General Description .....	1	Adding Gain.....	18
Revision History .....	2	Divider or Programmable Gain Element .....	19
Specifications.....	3	Reference Selection .....	19
Timing Characteristics .....	5	Amplifier Selection .....	19
Absolute Maximum Ratings.....	6	Serial Interface .....	21
ESD Caution.....	6	Microprocessor Interfacing.....	22
Pin Configurations and Function Descriptions .....	7	PCB Layout and Power Supply Decoupling .....	24
Typical Performance Characteristics .....	8	Outline Dimensions .....	26
Terminology .....	15	Ordering Guide .....	27
General Description .....	16	Automotive Products.....	27

## REVISION HISTORY

### 6/13—Rev. F to Rev. G

Change to General Description Section .....	1
Change to Figure 56 and Figure 57 .....	22
Updated Outline Dimensions .....	27
Changes to Ordering Guide .....	27

### 4/12—Rev. E to Rev. F

Changes to General Description Section .....	1
Deleted Evaluation Board for the DAC Section, Power Supplies for the Evaluation Board Section, and Figure 64;	
Renumbered Sequentially.....	25
Deleted Figure 65 and Figure 66.....	26
Deleted Figure 67.....	27
Changes to Ordering Guide .....	27

### 3/11—Rev. D to Rev. E

Changes to SYNC Function Section .....	21
Added Figure 54 (Renumbered Sequentially) .....	21
Added Figure 55 and Table 11 .....	22

### 2/11—Rev. C to Rev. D

Added 8-Lead LFCSP.....	Universal
Changes to Features Section.....	1
Updated Outline Dimensions .....	27
Changes to Ordering Guide .....	28
Added Automotive Products Section .....	28

### 1/10—Rev. B to Rev. C

Changes to DAC Control Bits C1, C0.....	21
Updated Outline Dimensions .....	27
Changes to Ordering Guide .....	28

### 3/06—Rev. A to Rev. B

Updated Format.....	Universal
Changes to Features .....	1
Changes to General Description .....	1
Changes to Specifications.....	4
Changes to Figure 27 and Figure 28.....	11
Change to Table 9 .....	20
Changes to Table 12 .....	26
Updated Outline Dimensions .....	27
Changes to Ordering Guide .....	28

### 7/05—Rev. 0 to Rev. A

Added AD5453 .....	Universal
Changes to Specifications.....	4
Change to Figure 21 .....	10
Updated Outline Dimensions .....	27
Changes to Ordering Guide .....	28

### 1/05—Revision 0: Initial Version

## SPECIFICATIONS

$V_{DD} = 2.5\text{ V to }5.5\text{ V}$ ,  $V_{REF} = 10\text{ V}$ . Temperature range for Y version:  $-40^{\circ}\text{C to }+125^{\circ}\text{C}$ . All specifications  $T_{MIN}$  to  $T_{MAX}$ , unless otherwise noted. DC performance measured with OP177 and ac performance measured with AD8038, unless otherwise noted.

Table 1.

Parameter	Min	Typ	Max	Unit	Test Conditions
<b>STATIC PERFORMANCE</b>					
AD5450					
Resolution			8	Bits	Guaranteed monotonic
Relative Accuracy			$\pm 0.25$	LSB	
Differential Nonlinearity			$\pm 0.5$	LSB	
Total Unadjusted Error			$\pm 0.5$	LSB	
Gain Error			$\pm 0.25$	LSB	
AD5451					
Resolution			10	Bits	Guaranteed monotonic
Relative Accuracy			$\pm 0.25$	LSB	
Differential Nonlinearity			$\pm 0.5$	LSB	
Total Unadjusted Error			$\pm 0.5$	LSB	
Gain Error			$\pm 0.25$	LSB	
AD5452					
Resolution			12	Bits	Guaranteed monotonic
Relative Accuracy			$\pm 0.5$	LSB	
Differential Nonlinearity			$\pm 1$	LSB	
Total Unadjusted Error			$\pm 1$	LSB	
Gain Error			$\pm 0.5$	LSB	
AD5453					
Resolution			14	Bits	Guaranteed monotonic
Relative Accuracy			$\pm 2$	LSB	
Differential Nonlinearity			$-1/+2$	LSB	
Total Unadjusted Error			$\pm 4$	LSB	
Gain Error			$\pm 2.5$	LSB	
Gain Error Temperature Coefficient <sup>1</sup>		$\pm 2$		ppm FSR/ $^{\circ}\text{C}$	
Output Leakage Current			$\pm 1$	nA	Data = 0x0000, $T_A = 25^{\circ}\text{C}$ , $I_{OUT1}$
			$\pm 10$	nA	Data = 0x0000, $T_A = -40^{\circ}\text{C to }+125^{\circ}\text{C}$ , $I_{OUT1}$
<b>REFERENCE INPUT<sup>1</sup></b>					
Reference Input Range		$\pm 10$		V	
$V_{REF}$ Input Resistance	7	9	11	k $\Omega$	Input resistance, $TC = -50\text{ ppm}/^{\circ}\text{C}$
$R_{FB}$ Feedback Resistance	7	9	11	k $\Omega$	Input resistance, $TC = -50\text{ ppm}/^{\circ}\text{C}$
Input Capacitance					
Zero-Scale Code		18	22	pF	
Full-Scale Code		18	22	pF	
<b>DIGITAL INPUTS/OUTPUTS<sup>1</sup></b>					
Input High Voltage, $V_{IH}$	2.0			V	$V_{DD} = 3.6\text{ V to }5\text{ V}$
	1.7			V	$V_{DD} = 2.5\text{ V to }3.6\text{ V}$
Input Low Voltage, $V_{IL}$			0.8	V	$V_{DD} = 2.7\text{ V to }5.5\text{ V}$
			0.7	V	$V_{DD} = 2.5\text{ V to }2.7\text{ V}$
Output High Voltage, $V_{OH}$	$V_{DD} - 1$			V	$V_{DD} = 4.5\text{ V to }5\text{ V}$ , $I_{SOURCE} = 200\text{ }\mu\text{A}$
	$V_{DD} - 0.5$			V	$V_{DD} = 2.5\text{ V to }3.6\text{ V}$ , $I_{SOURCE} = 200\text{ }\mu\text{A}$
Output Low Voltage, $V_{OL}$			0.4	V	$V_{DD} = 4.5\text{ V to }5\text{ V}$ , $I_{SINK} = 200\text{ }\mu\text{A}$
			0.4	V	$V_{DD} = 2.5\text{ V to }3.6\text{ V}$ , $I_{SINK} = 200\text{ }\mu\text{A}$
Input Leakage Current, $I_{IL}$			$\pm 1$	nA	$T_A = 25^{\circ}\text{C}$
			$\pm 10$	nA	$T_A = -40^{\circ}\text{C to }+125^{\circ}\text{C}$
Input Capacitance			10	pF	

Parameter	Min	Typ	Max	Unit	Test Conditions
<b>DYNAMIC PERFORMANCE<sup>1</sup></b>					
Reference-Multiplying BW		12		MHz	$V_{REF} = \pm 3.5\text{ V}$ , DAC loaded with all 1s
Multiplying Feedthrough Error		72		dB	$V_{REF} = \pm 3.5\text{ V}$ , DAC loaded with all 0s
		64		dB	100 kHz
		44		dB	1 MHz
					10 MHz
Output Voltage Settling Time					$V_{REF} = 10\text{ V}$ , $R_{LOAD} = 100\ \Omega$ ; DAC latch alternately loaded with 0s and 1s
Measured to $\pm 1\text{ mV}$ of FS		100	110	ns	
Measured to $\pm 4\text{ mV}$ of FS		24	40	ns	
Measured to $\pm 16\text{ mV}$ of FS		16	33	ns	
Digital Delay		20	40	ns	Interface delay time
10% to 90% Settling Time		10	30	ns	Rise and fall times, $V_{REF} = 10\text{ V}$ , $R_{LOAD} = 100\ \Omega$
Digital-to-Analog Glitch Impulse		2		nV-s	1 LSB change around major carry, $V_{REF} = 0\text{ V}$
Output Capacitance					
$I_{OUT1}$		13		pF	DAC latches loaded with all 0s
		28		pF	DAC latches loaded with all 1s
$I_{OUT2}$		18		pF	DAC latches loaded with all 0s
		5		pF	DAC latches loaded with all 1s
Digital Feedthrough		0.5		nV-s	Feedthrough to DAC output with $\overline{CS}$ high and alternate loading of all 0s and all 1s
Analog THD		83		dB	$V_{REF} = 3.5\text{ V p-p}$ , all 1s loaded, $f = 1\text{ kHz}$
Digital THD					Clock = 1 MHz, $V_{REF} = 3.5\text{ V}$
50 kHz $f_{OUT}$		71		dB	
20 kHz $f_{OUT}$		77		dB	
Output Noise Spectral Density		25		nV/ $\sqrt{\text{Hz}}$	@ 1 kHz
SFDR Performance (Wide Band)					Clock = 1 MHz, $V_{REF} = 3.5\text{ V}$
50 kHz $f_{OUT}$		78		dB	
20 kHz $f_{OUT}$		74		dB	
SFDR Performance (Narrow Band)					Clock = 1 MHz, $V_{REF} = 3.5\text{ V}$
50 kHz $f_{OUT}$		87		dB	
20 kHz $f_{OUT}$		85		dB	
Intermodulation Distortion		79		dB	$f_1 = 20\text{ kHz}$ , $f_2 = 25\text{ kHz}$ , clock = 1 MHz, $V_{REF} = 3.5\text{ V}$
<b>POWER REQUIREMENTS</b>					
Power Supply Range	2.5		5.5	V	
$I_{DD}$		0.4	10	$\mu\text{A}$	$T_A = -40^\circ\text{C}$ to $+125^\circ\text{C}$ , logic inputs = 0 V or $V_{DD}$
			0.6	$\mu\text{A}$	$T_A = 25^\circ\text{C}$ , logic inputs = 0 V or $V_{DD}$
Power Supply Sensitivity <sup>1</sup>			0.001	%/%	$\Delta V_{DD} = \pm 5\%$

<sup>1</sup> Guaranteed by design and characterization, not subject to production test.

**TIMING CHARACTERISTICS**

All input signals are specified with  $t_R = t_F = 1 \text{ ns}$  (10% to 90% of  $V_{DD}$ ) and timed from a voltage level of  $(V_{IL} + V_{IH})/2$ .  $V_{DD} = 2.5 \text{ V}$  to  $5.5 \text{ V}$ ,  $V_{REF} = 10 \text{ V}$ , temperature range for Y version:  $-40^\circ\text{C}$  to  $+125^\circ\text{C}$ . All specifications  $T_{MIN}$  to  $T_{MAX}$ , unless otherwise noted.

**Table 2.**

Parameter <sup>1</sup>	$V_{DD} = 2.5 \text{ V to } 5.5 \text{ V}$	Unit	Description
$f_{SCLK}$	50	MHz max	Maximum clock frequency
$t_1$	20	ns min	SCLK cycle time
$t_2$	8	ns min	SCLK high time
$t_3$	8	ns min	SCLK low time
$t_4$	8	ns min	$\overline{\text{SYNC}}$ falling edge to SCLK active edge setup time
$t_5$	5	ns min	Data setup time
$t_6$	4.5	ns min	Data hold time
$t_7$	5	ns min	$\overline{\text{SYNC}}$ rising edge to SCLK active edge
$t_8$	30	ns min	Minimum $\overline{\text{SYNC}}$ high time
Update Rate	2.7	MSPS	Consists of cycle time, $\overline{\text{SYNC}}$ high time, data setup, and output voltage settling time

<sup>1</sup> Guaranteed by design and characterization, not subject to production test.

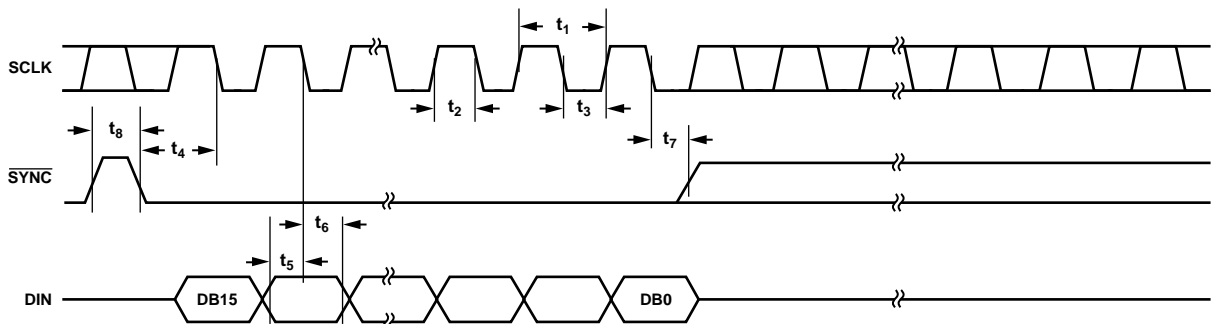

Figure 2. Timing Diagram

0-4987-002

## ABSOLUTE MAXIMUM RATINGS

Transient currents of up to 100 mA do not cause SCR latch-up.  
 $T_A = 25^\circ\text{C}$ , unless otherwise noted.

Table 3.

Parameter	Rating
$V_{DD}$ to GND	-0.3 V to +7 V
$V_{REF}$ , $R_{FB}$ to GND	-12 V to +12 V
$I_{OUT1}$ to GND	-0.3 V to +7 V
Input Current to Any Pin Except Supplies	$\pm 10$ mA
Logic Inputs and Output <sup>1</sup>	-0.3 V to $V_{DD} + 0.3$ V
Operating Temperature Range, Extended (Y Version)	-40°C to +125°C
Storage Temperature Range	-65°C to +150°C
Junction Temperature	150°C
$\theta_{JA}$ Thermal Impedance	
8-Lead MSOP	206°C/W
8-Lead TSOT	211°C/W
Lead Temperature, Soldering (10 sec)	300°C
IR Reflow, Peak Temperature (<20 sec)	235°C

<sup>1</sup> Overvoltages at SCLK,  $\overline{\text{SYNC}}$ , and SDIN are clamped by internal diodes.

Stresses above those listed under Absolute Maximum Ratings may cause permanent damage to the device. This is a stress rating only; functional operation of the device at these or any other conditions above those indicated in the operational section of this specification is not implied. Exposure to absolute maximum rating conditions for extended periods may affect device reliability.

### ESD CAUTION



**ESD (electrostatic discharge) sensitive device.** Charged devices and circuit boards can discharge without detection. Although this product features patented or proprietary protection circuitry, damage may occur on devices subjected to high energy ESD. Therefore, proper ESD precautions should be taken to avoid performance degradation or loss of functionality.

# PIN CONFIGURATIONS AND FUNCTION DESCRIPTIONS

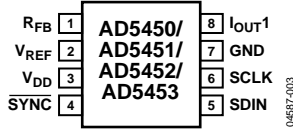

Figure 3. 8-Lead TSOT Pin Configuration

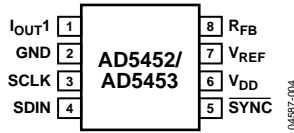
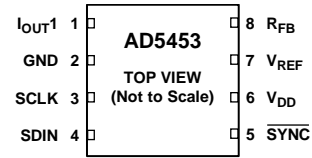

Figure 4. 8-Lead MSOP Pin Configuration



**NOTES**

- 1. THE EXPOSED PAD MUST BE CONNECTED TO GROUND.

Figure 5. 8-Lead LFCSP Pin Configuration

**Table 4. Pin Function Descriptions**

Pin No <sup>1</sup>			Mnemonic	Description
TSOT	MSOP	LFCSP		
1	8	8	RFB	DAC Feedback Resistor. Establish voltage output for the DAC by connecting to external amplifier output.
2	7	7	VREF	DAC Reference Voltage Input.
3	6	6	VDD	Positive Power Supply Input. These parts can operate from a supply of 2.5 V to 5.5 V.
4	5	5	SYNC	Active Low Control Input. This is the frame synchronization signal for the input data. Data is loaded to the shift register upon the active edge of the following clocks.
5	4	4	SDIN	Serial Data Input. Data is clocked into the 16-bit input register upon the active edge of the serial clock input. By default, in power-up mode data is clocked into the shift register upon the falling edge of SCLK. The control bits allow the user to change the active edge to a rising edge.
6	3	3	SCLK	Serial Clock Input. By default, data is clocked into the input shift register upon the falling edge of the serial clock input. Alternatively, by means of the serial control bits, the device can be configured such that data is clocked into the shift register upon the rising edge of SCLK.
7	2	2	GND	Ground Pin.
8	1	1	IOUT1	DAC Current Output.
N/A	N/A	EPAD	EPAD	Exposed pad must be connected to ground.

<sup>1</sup> N/A = not applicable.

TYPICAL PERFORMANCE CHARACTERISTICS

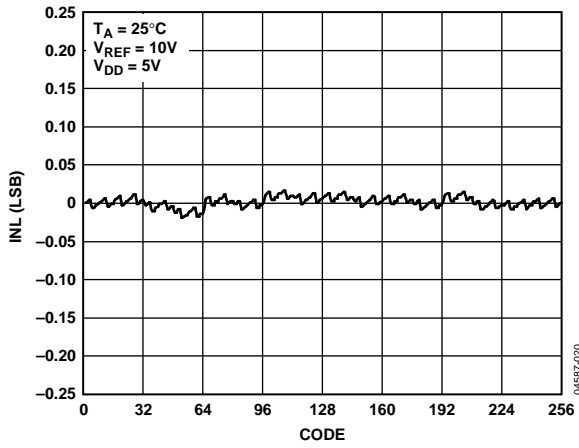

Figure 6. INL vs. Code (8-Bit DAC)

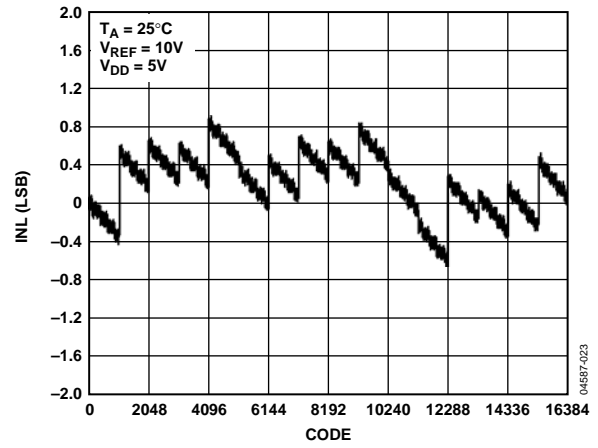

Figure 9. INL vs. Code (14-Bit DAC)

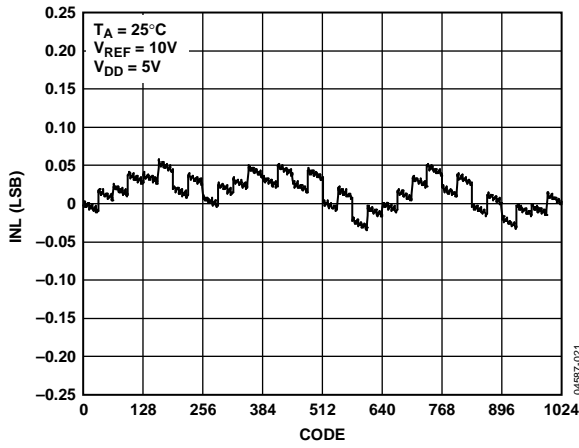

Figure 7. INL vs. Code (10-Bit DAC)

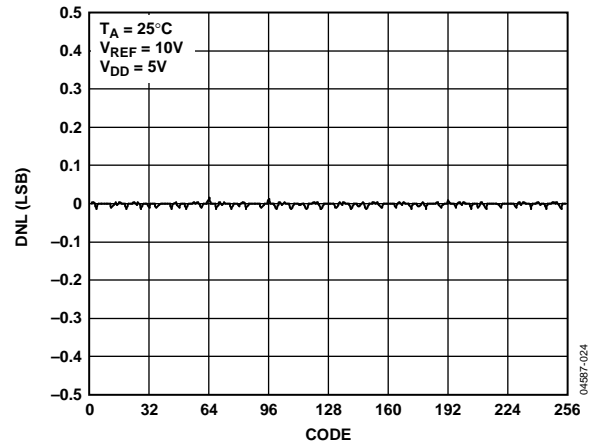

Figure 10. DNL vs. Code (8-Bit DAC)

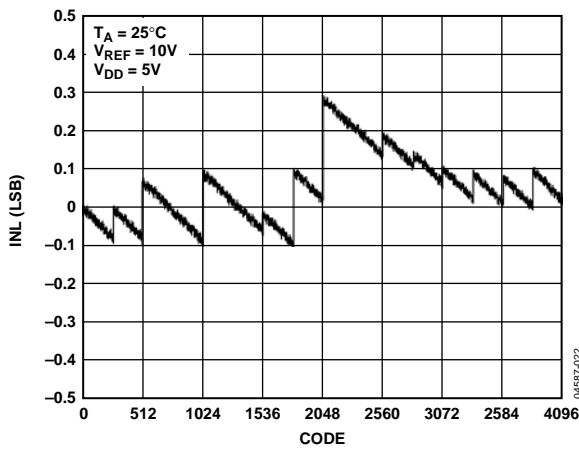

Figure 8. INL vs. Code (12-Bit DAC)

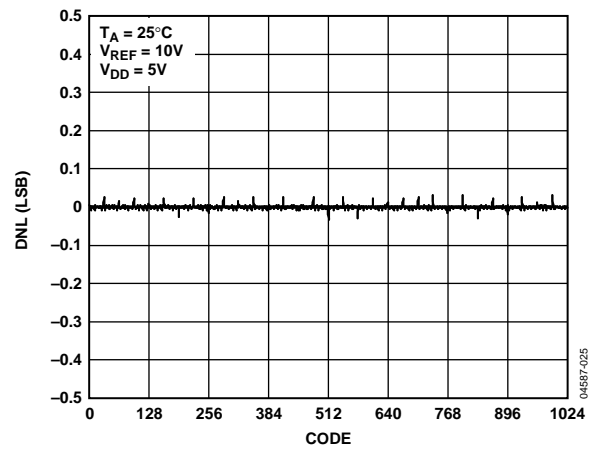

Figure 11. DNL vs. Code (10-Bit DAC)



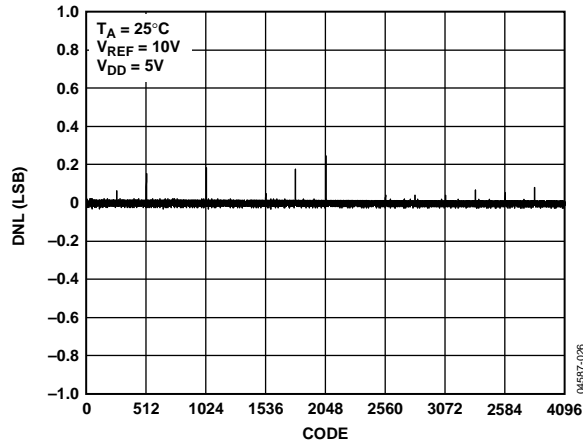

Figure 12. DNL vs. Code (12-Bit DAC)

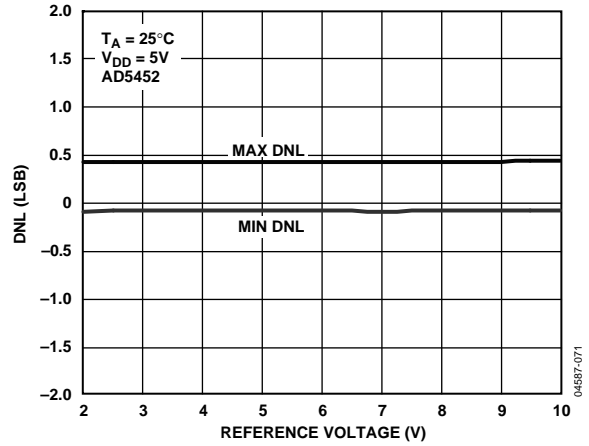

Figure 15. DNL vs. Reference Voltage

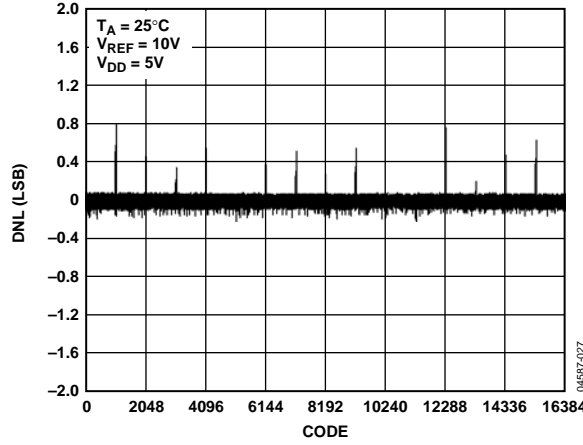

Figure 13. DNL vs. Code (14-Bit DAC)

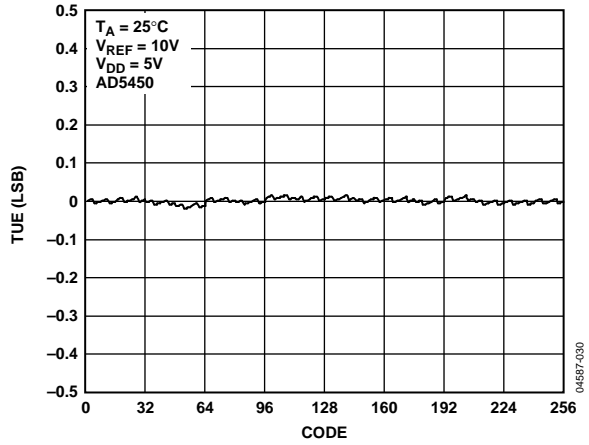

Figure 16. TUE vs. Code (8-Bit DAC)

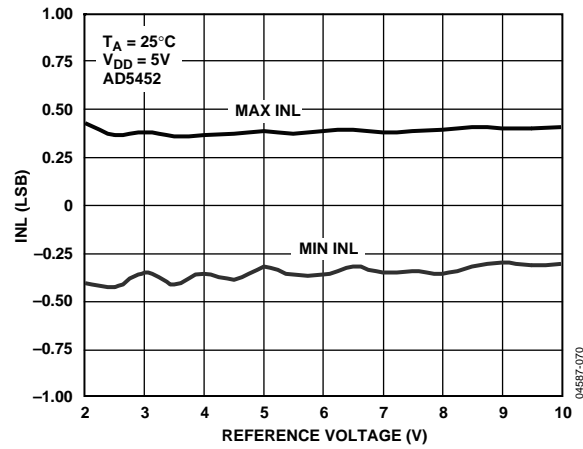

Figure 14. INL vs. Reference Voltage

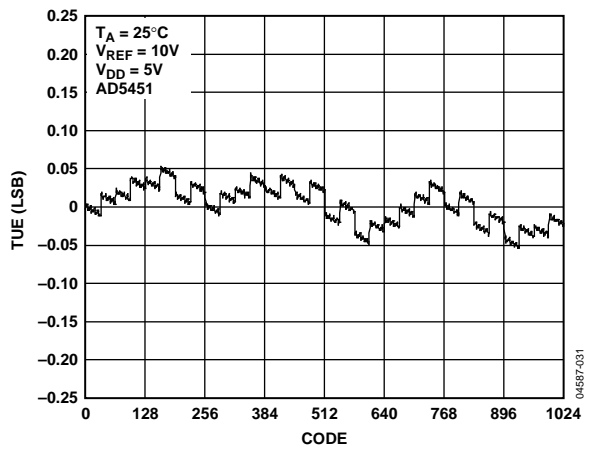

Figure 17. TUE vs. Code (10-Bit DAC)

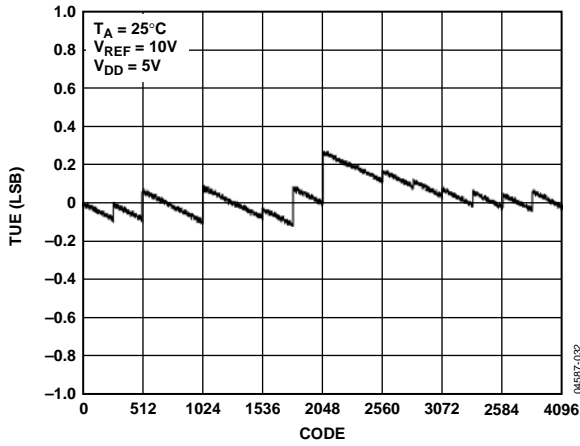

Figure 18. TUE vs. Code (12-Bit DAC)

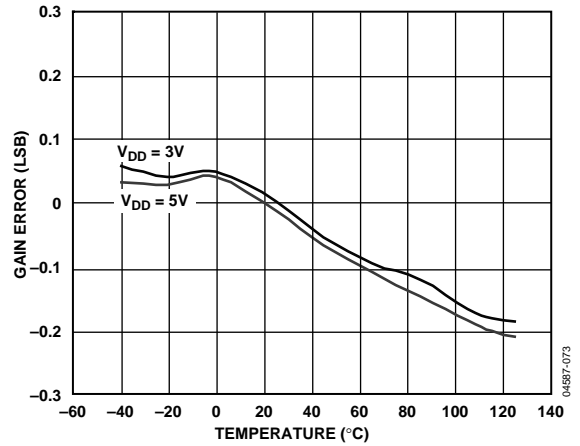

Figure 21. Gain Error (LSB) vs. Temperature

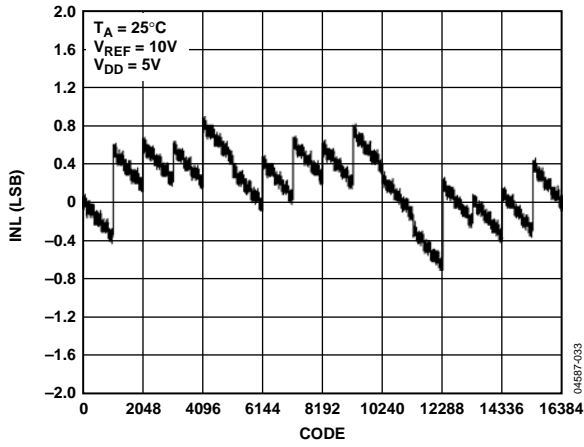

Figure 19. TUE vs. Code (14-Bit DAC)

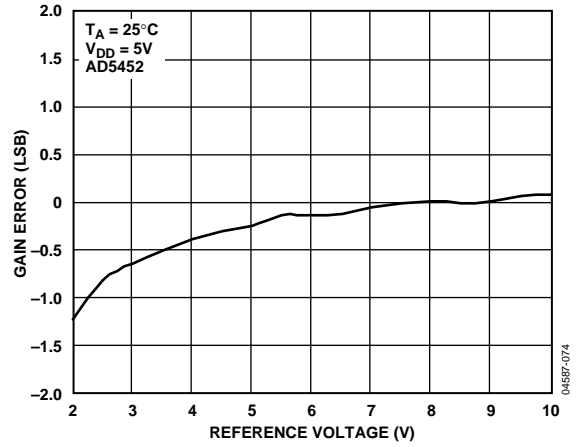

Figure 22. Gain Error (LSB) vs. Reference Voltage

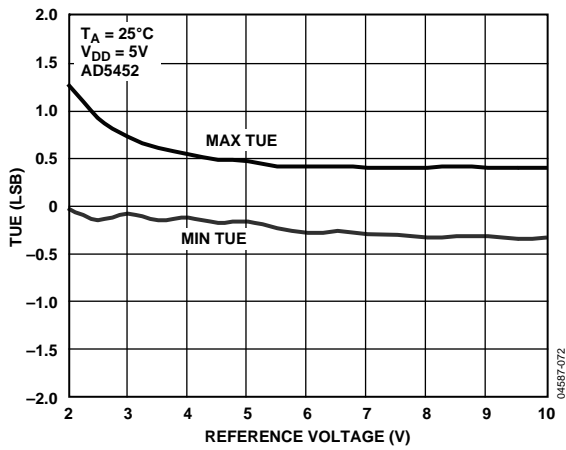

Figure 20. TUE vs. Reference Voltage

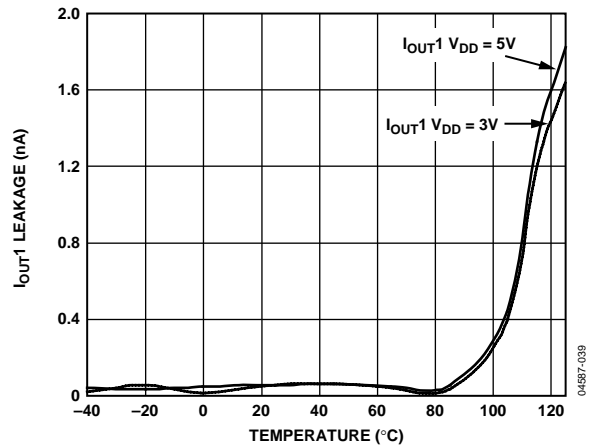

Figure 23.  $I_{OUT1}$  Leakage Current vs. Temperature

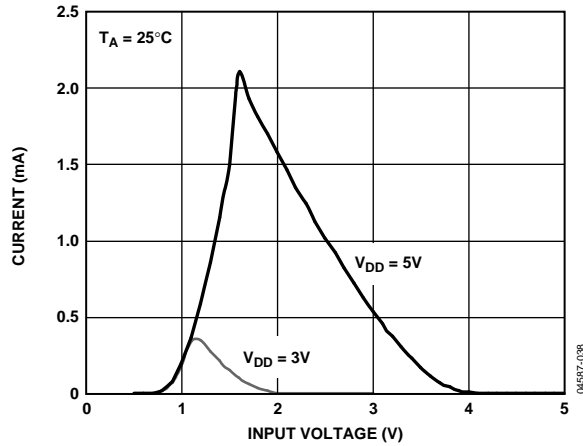

Figure 24. Supply Current vs. Logic Input Voltage

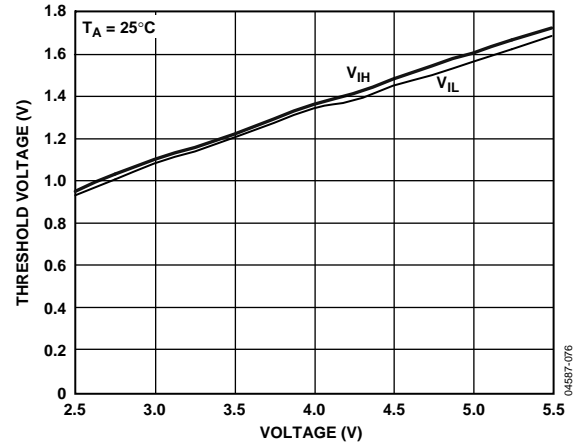

Figure 27. Threshold Voltage vs. Supply Voltage

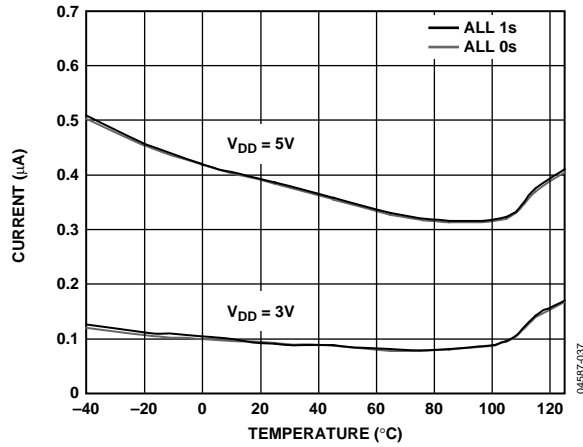

Figure 25. Supply Current vs. Temperature

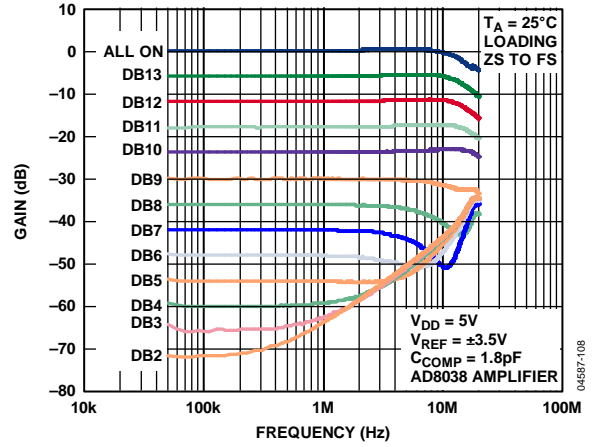

Figure 28. Reference Multiplying Bandwidth vs. Frequency and Code

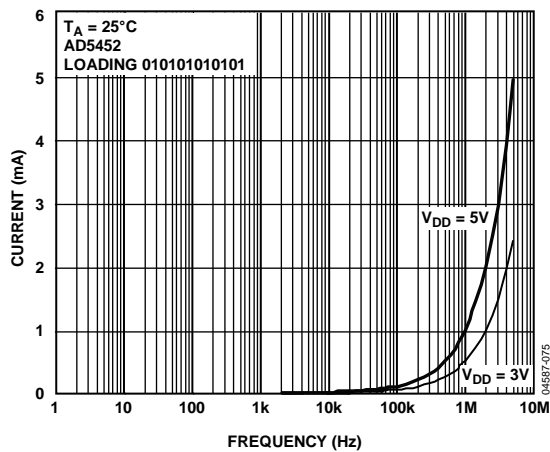

Figure 26. Supply Current vs. Update Rate

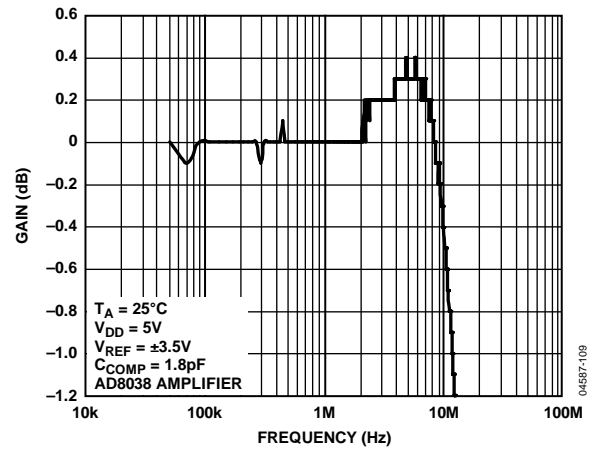

Figure 29. Reference Multiplying Bandwidth—All 1s Loaded

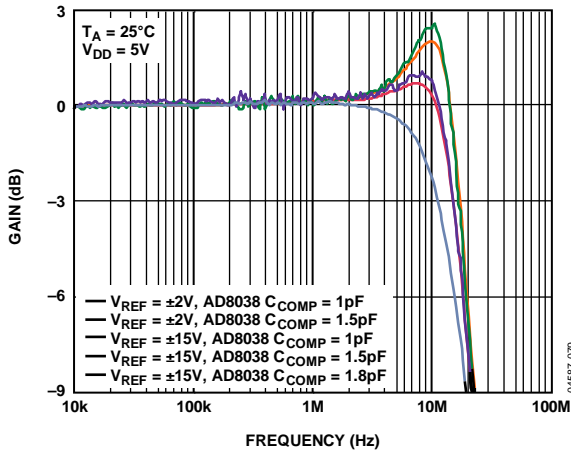

Figure 30. Reference Multiplying Bandwidth vs. Frequency and Compensation Capacitor

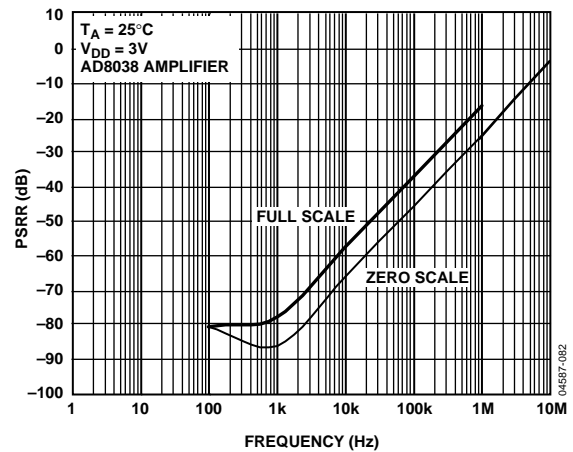

Figure 33. Power Supply Rejection Ratio vs. Frequency

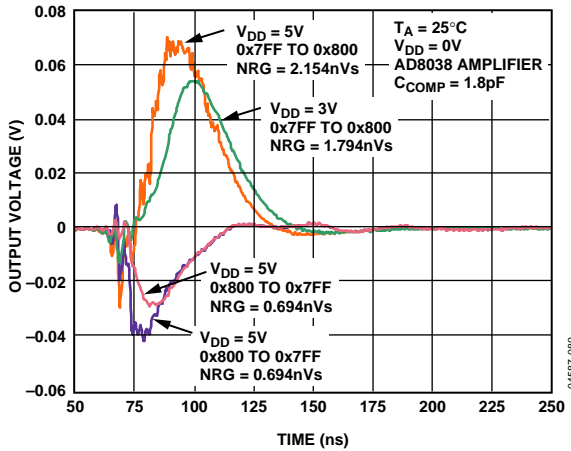

Figure 31. Midscale Transition,  $V_{REF} = 0V$

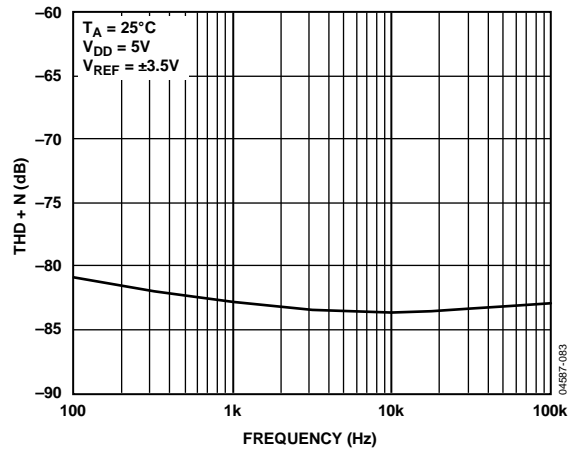

Figure 34. THD + Noise vs. Frequency

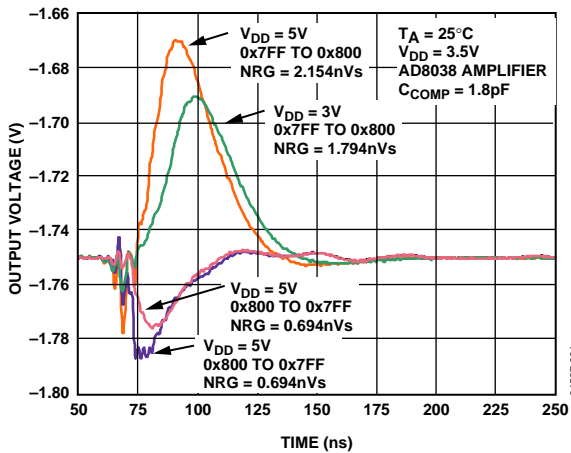

Figure 32. Midscale Transition,  $V_{REF} = 3.5V$

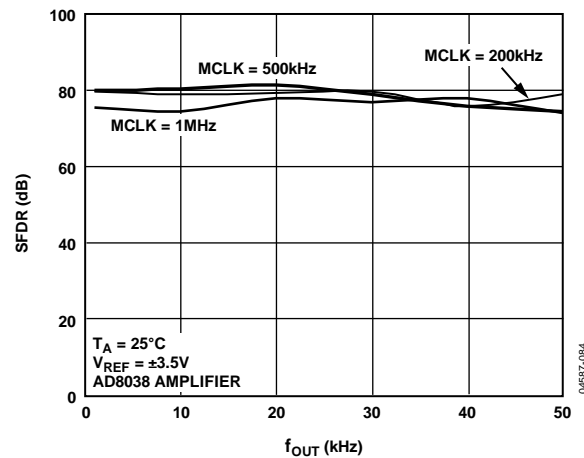

Figure 35. Wideband SFDR vs.  $f_{OUT}$  Frequency

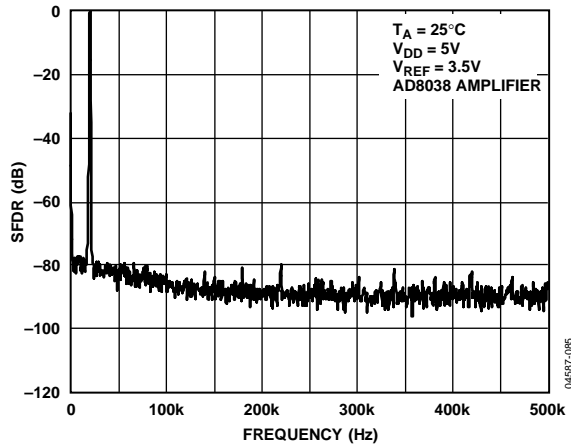

Figure 36. Wideband SFDR,  $f_{OUT} = 20\text{ kHz}$ , Clock = 1 MHz

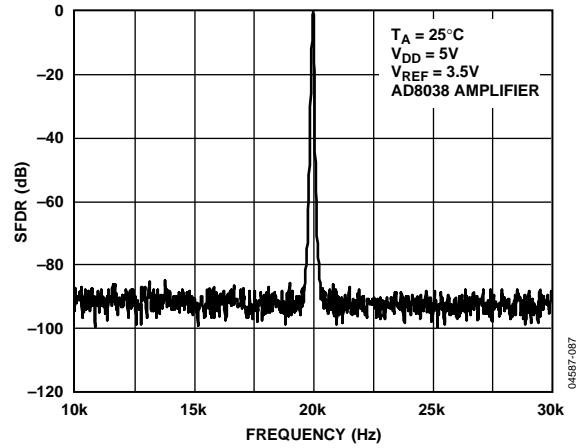

Figure 38. Narrow-Band SFDR,  $f_{OUT} = 20\text{ kHz}$ , Clock = 1 MHz

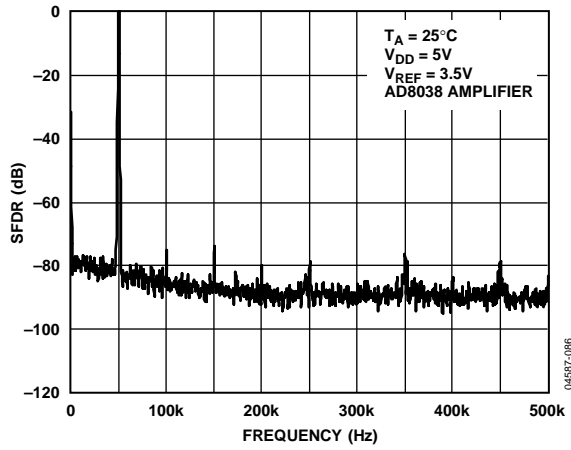

Figure 37. Wideband SFDR,  $f_{OUT} = 50\text{ kHz}$ , Clock = 1 MHz

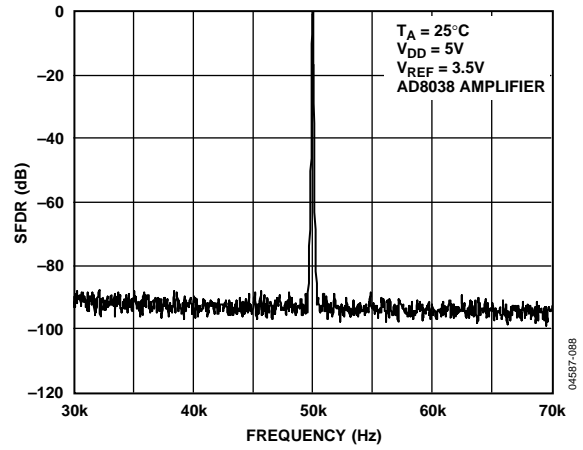

Figure 39. Narrow-Band SFDR,  $f_{OUT} = 50\text{ kHz}$ , Clock = 1 MHz

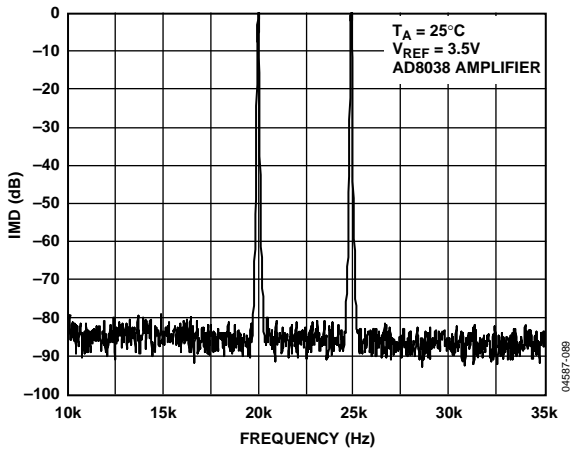

Figure 40. Narrow-Band IMD,  $f_{OUT} = 20\text{ kHz}, 25\text{ kHz}$ , Clock = 1 MHz

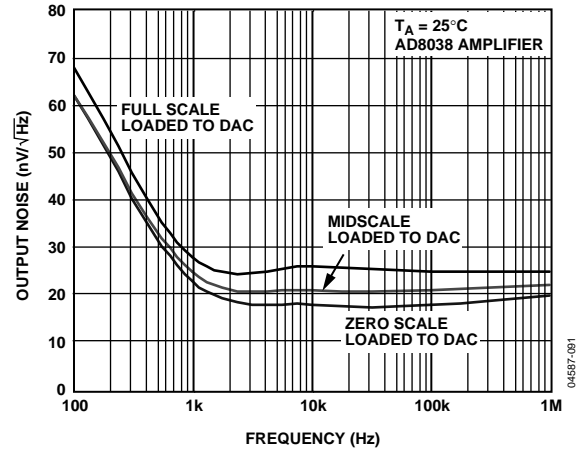

Figure 42. Output Noise Spectral Density

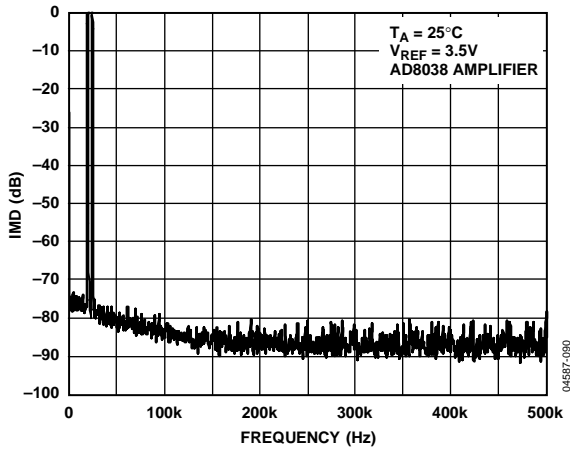

Figure 41. Wideband IMD,  $f_{OUT} = 20\text{ kHz}, 25\text{ kHz}$ , Clock = 1 MHz

## TERMINOLOGY

### Relative Accuracy (Endpoint Nonlinearity)

A measure of the maximum deviation from a straight line passing through the endpoints of the DAC transfer function. It is measured after adjusting for zero and full scale and is normally expressed in LSBs or as a percentage of the full-scale reading.

### Differential Nonlinearity

The difference between the measured change and the ideal 1 LSB change between any two adjacent codes. A specified differential nonlinearity of  $-1$  LSB maximum over the operating temperature range ensures monotonicity.

### Gain Error (Full-Scale Error)

A measure of the output error between an ideal DAC and the actual device output. For these DACs, ideal maximum output is  $V_{REF} - 1$  LSB. Gain error of the DACs is adjustable to zero with external resistance.

### Output Leakage Current

The current that flows into the DAC ladder switches when it is turned off. For the  $I_{OUT1}$  terminal, it can be measured by loading all 0s to the DAC and measuring the  $I_{OUT1}$  current.

### Output Capacitance

Capacitance from  $I_{OUT1}$  to AGND.

### Output Current Settling Time

The amount of time it takes for the output to settle to a specified level for a full-scale input change. For these devices, it is specified with a  $100\ \Omega$  resistor to ground. The settling time specification includes the digital delay from the  $\overline{SYNC}$  rising edge to the full-scale output change.

### Digital-to-Analog Glitch Impulse

The amount of charge injected from the digital inputs to the analog output when the inputs change state. This is normally specified as the area of the glitch in either pA-s or nV-s, depending on whether the glitch is measured as a current or voltage signal.

### Digital Feedthrough

When the device is not selected, high frequency logic activity on the device's digital inputs may be capacitively coupled through the device and produce noise on the  $I_{OUT}$  pins. This noise is coupled from the outputs of the device onto follow-on circuitry. This noise is digital feedthrough.

### Multiplying Feedthrough Error

The error due to capacitive feedthrough from the DAC reference input to the DAC  $I_{OUT1}$  terminal when all 0s are loaded to the DAC.

### Total Harmonic Distortion (THD)

The DAC is driven by an ac reference. The ratio of the rms sum of the harmonics of the DAC output to the fundamental value is the THD. Usually only the lower-order harmonics, such as second to fifth, are included.

$$THD = 20 \log \frac{\sqrt{V_2^2 + V_3^2 + V_4^2 + V_5^2}}{V_1}$$

### Digital Intermodulation Distortion (IMD)

Second-order intermodulation measurements are the relative magnitudes of the fa and fb tones generated digitally by the DAC and the second-order products at  $2fa - fb$  and  $2fb - fa$ .

### Compliance Voltage Range

The maximum range of (output) terminal voltage for which the device provides the specified characteristics.

### Spurious-Free Dynamic Range (SFDR)

The usable dynamic range of a DAC before spurious noise interferes or distorts the fundamental signal. SFDR is the measure of difference in amplitude between the fundamental and the largest harmonically or nonharmonically related spur from dc to full Nyquist bandwidth (half the DAC sampling rate or  $f_s/2$ ). Narrow-band SFDR is a measure of SFDR over an arbitrary window size, in this case 50% of the fundamental. Digital SFDR is a measure of the usable dynamic range of the DAC when the signal is a digitally generated sine wave.

## GENERAL DESCRIPTION

### DAC SECTION

The AD5450/AD5451/AD5452/AD5453 are 8-/10-/12-/14-bit current output DACs, respectively, consisting of a segmented (4-bit) inverting R-2R ladder configuration. A simplified diagram for the 12-bit AD5452 is shown in Figure 43.

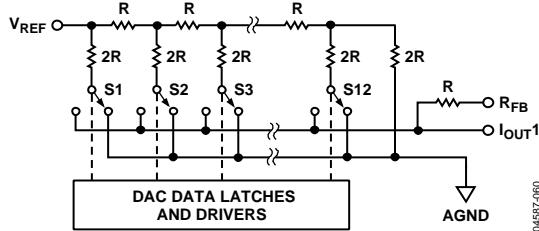

Figure 43. AD5452 Simplified Ladder

The feedback resistor, R<sub>FB</sub>, has a value of R. The value of R is typically 9 kΩ (with a minimum value of 7 kΩ and a maximum value of 11 kΩ). If I<sub>OUT1</sub> is kept at the same potential as GND, a constant current flows in each ladder leg, regardless of digital input code. Therefore, the input resistance presented at V<sub>REF</sub> is always constant and nominally of value R. The DAC output (I<sub>OUT1</sub>) is code-dependent, producing various resistances and capacitances. When choosing the external amplifier, take into account the variation in impedance generated by the DAC on the amplifier's inverting input node.

Access is provided to the V<sub>REF</sub>, R<sub>FB</sub>, and I<sub>OUT1</sub> terminals of the DAC, making the device extremely versatile and allowing it to be configured in several operating modes; for example, it can provide a unipolar output or can provide 4-quadrant multiplication in bipolar mode. Note that a matching switch is used in series with the internal R<sub>FB</sub> feedback resistor. If users attempt to measure R<sub>FB</sub>, power must be applied to V<sub>DD</sub> to achieve continuity.

### CIRCUIT OPERATION

#### Unipolar Mode

Using a single op amp, these devices can easily be configured to provide a 2-quadrant multiplying operation or a unipolar output voltage swing, as shown in Figure 44. When an output amplifier is connected in unipolar mode, the output voltage is given by

$$V_{OUT} = -\frac{D}{2^n} \times V_{REF}$$

where:

D is the fractional representation of the digital word loaded to the DAC.

- D = 0 to 255 (8-bit AD5450).
- = 0 to 1023 (10-bit AD5451).
- = 0 to 4095 (12-bit AD5452).
- = 0 to 16,383 (14-bit AD5453).

n is the number of bits.

Note that the output voltage polarity is opposite to the V<sub>REF</sub> polarity for dc reference voltages.

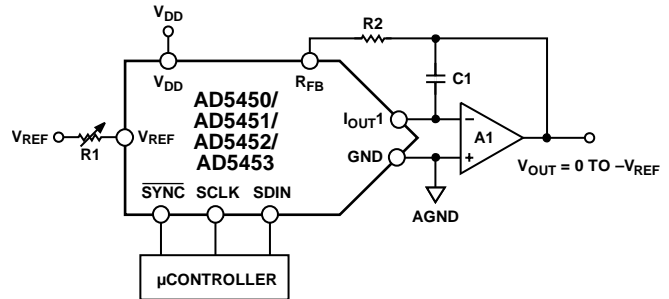

- NOTES
1. R1 AND R2 USED ONLY IF GAIN ADJUSTMENT IS REQUIRED.
  2. C1 PHASE COMPENSATION (1pF TO 2pF) MAY BE REQUIRED IF A1 IS A HIGH SPEED AMPLIFIER.

Figure 44. Unipolar Mode Operation

These DACs are designed to operate with either negative or positive reference voltages. The V<sub>DD</sub> power pin is only used by the internal digital logic to drive the on and off states of the DAC switches.

These DACs are designed to accommodate ac reference input signals in the range of -10 V to +10 V.

With a fixed 10 V reference, the circuit shown in Figure 44 gives a unipolar 0 V to -10 V output voltage swing. When V<sub>IN</sub> is an ac signal, the circuit performs 2-quadrant multiplication.

Table 5 shows the relationship between the digital code and the expected output voltage for a unipolar operation using the 8-bit AD5450.

Table 5. Unipolar Code Table for the AD5450

Digital Input	Analog Output (V)
1111 1111	-V <sub>REF</sub> (255/256)
1000 0000	-V <sub>REF</sub> (128/256) = -V <sub>REF</sub> /2
0000 0001	-V <sub>REF</sub> (1/256)
0000 0000	-V <sub>REF</sub> (0/256) = 0



**Bipolar Mode**

In some applications, it may be necessary to generate a full 4-quadrant multiplying operation or a bipolar output swing. This can be easily accomplished by using another external amplifier and some external resistors, as shown in Figure 45. In this circuit, the second amplifier, A2, provides a gain of 2. Biasing the external amplifier with an offset from the reference voltage results in full 4-quadrant multiplying operation. The transfer function of this circuit shows that both negative and positive output voltages are created as the input data (D) is incremented from Code 0 ( $V_{OUT} = -V_{REF}$ ) to midscale ( $V_{OUT} = 0V$ ) to full scale ( $V_{OUT} = +V_{REF}$ ).

$$V_{OUT} = \left( V_{REF} \times \frac{D}{2^{n-1}} \right) - V_{REF}$$

where:

D is the fractional representation of the digital word loaded to the DAC.

- D = 0 to 255 (8-bit AD5450).
- D = 0 to 1023 (10-bit AD5451).
- D = 0 to 4095 (12-bit AD5452).

n is the resolution of the DAC.

When  $V_{IN}$  is an ac signal, the circuit performs 4-quadrant multiplication. Table 6 shows the relationship between the digital code and the expected output voltage for a bipolar operation using the 8-bit AD5450.

**Table 6. Bipolar Code Table for the AD5450**

Digital Input	Analog Output (V)
1111 1111	+V <sub>REF</sub> (127/128)
1000 0000	0
0000 0001	-V <sub>REF</sub> (127/128)
0000 0000	-V <sub>REF</sub> (128/128)

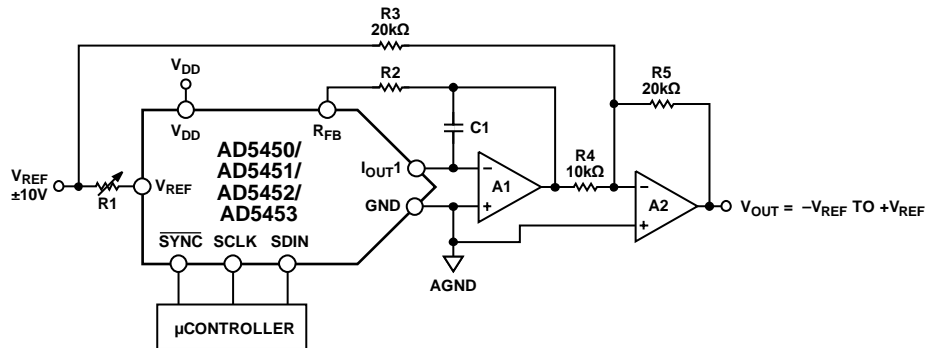

- NOTES**
1. R1 AND R2 USED ONLY IF GAIN ADJUSTMENT IS REQUIRED. ADJUST R1 FOR  $V_{OUT} = 0V$  WITH CODE 10000000 LOADED TO DAC.
  2. MATCHING AND TRACKING IS ESSENTIAL FOR RESISTOR PAIRS R3 AND R4.
  3. C1 PHASE COMPENSATION (1pF TO 2pF) MAY BE REQUIRED IF A1/A2 IS A HIGH SPEED AMPLIFIER.

Figure 45. Bipolar Mode Operation (4-Quadrant Multiplication)

04587-010

**Stability**

In the I-to-V configuration, the I<sub>OUT</sub> of the DAC and the inverting node of the op amp must be connected as close as possible, and proper PCB layout techniques must be employed. Because every code change corresponds to a step function, gain peaking may occur if the op amp has limited gain bandwidth product (GBP) and there is excessive parasitic capacitance at the inverting node. This parasitic capacitance introduces a pole into the open-loop response, which can cause ringing or instability in the closed-loop applications circuit.

An optional compensation capacitor, C1, can be added in parallel with R<sub>FB</sub> for stability, as shown in Figure 44 and Figure 45. Too small a value of C1 can produce ringing at the output, and too large a value can adversely affect the settling time. C1 should be found empirically, but 1 pF to 2 pF is generally adequate for the compensation.

**SINGLE-SUPPLY APPLICATIONS**

**Voltage-Switching Mode**

Figure 46 shows these DACs operating in the voltage-switching mode. The reference voltage, V<sub>IN</sub>, is applied to the I<sub>OUT1</sub> pin, and the output voltage is available at the V<sub>REF</sub> terminal. In this configuration, a positive reference voltage results in a positive output voltage, making single-supply operation possible. The output from the DAC is voltage at a constant impedance (the DAC ladder resistance); therefore, an op amp is necessary to buffer the output voltage. The reference input no longer sees constant input impedance, but one that varies with code; therefore, the voltage input should be driven from a low impedance source.

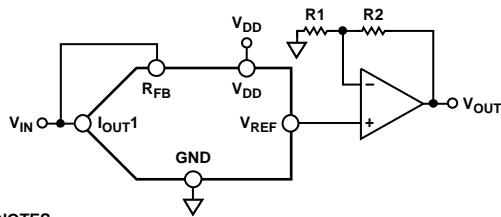

- NOTES  
 1. ADDITIONAL PINS OMITTED FOR CLARITY.  
 2. C1 PHASE COMPENSATION (1pF TO 2pF) MAY BE REQUIRED IF A1 IS A HIGH SPEED AMPLIFIER.

Figure 46. Single-Supply Voltage-Switching Mode

It is important to note that with this configuration V<sub>IN</sub> is limited to low voltages because the switches in the DAC ladder do not have the same source-drain drive voltage. As a result, their on resistance differs, which degrades the integral linearity of the DAC. Also, V<sub>IN</sub> must not go negative by more than 0.3 V, or an internal diode turns on, causing the device to exceed the maximum ratings. In this type of application, the full range of multiplying capability of the DAC is lost.

**Positive Output Voltage**

The output voltage polarity is opposite to the V<sub>REF</sub> polarity for dc reference voltages. To achieve a positive voltage output, an applied negative reference to the input of the DAC is preferred over the output inversion through an inverting amplifier because of the resistors' tolerance errors. To generate a negative reference, the reference can be level-shifted by an op amp such that the V<sub>OUT</sub> and GND pins of the reference become the virtual ground and -2.5 V, respectively, as shown in Figure 47.

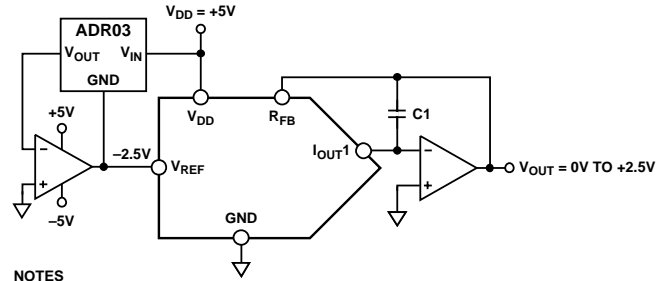

- NOTES  
 1. ADDITIONAL PINS OMITTED FOR CLARITY.  
 2. C1 PHASE COMPENSATION (1pF TO 2pF) MAY BE REQUIRED IF A1 IS A HIGH SPEED AMPLIFIER.

Figure 47. Positive Output Voltage with Minimum Components

**ADDING GAIN**

In applications in which the output voltage is required to be greater than V<sub>IN</sub>, gain can be added with an additional external amplifier, or it can be achieved in a single stage. It is important to consider the effect of the temperature coefficients of the DAC's thin film resistors. Simply placing a resistor in series with the R<sub>FB</sub> resistor causes mismatches in the temperature coefficients and results in larger gain temperature coefficient errors. Instead, increase the gain of the circuit by using the recommended configuration shown in Figure 48. R1, R2, and R3 should have similar temperature coefficients, but they need not match the temperature coefficients of the DAC. This approach is recommended in circuits where gains greater than 1 are required.

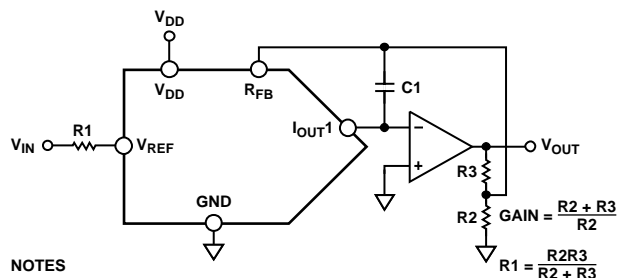

- NOTES  
 1. ADDITIONAL PINS OMITTED FOR CLARITY.  
 2. C1 PHASE COMPENSATION (1pF TO 2pF) MAY BE REQUIRED IF A1 IS A HIGH SPEED AMPLIFIER.

Figure 48. Increasing Gain of Current-Output DAC

## DIVIDER OR PROGRAMMABLE GAIN ELEMENT

Current-steering DACs are very flexible and lend themselves to many different applications. If this type of DAC is connected as the feedback element of an op amp and  $R_{FB}$  is used as the input resistor as shown in Figure 49, the output voltage is inversely proportional to the digital input fraction,  $D$ .

For  $D = 1 - 2^{-n}$ , the output voltage is

$$V_{OUT} = \frac{-V_{IN}}{D} = \frac{-V_{IN}}{(1 - 2^{-n})}$$

As  $D$  is reduced, the output voltage increases. For small values of the digital fraction,  $D$ , it is important to ensure that the amplifier does not saturate and that the required accuracy is met. For example, an 8-bit DAC driven with the binary code 0x10 (00010000), that is, 16 decimal, in the circuit of Figure 49 should cause the output voltage to be 16 times  $V_{IN}$ .

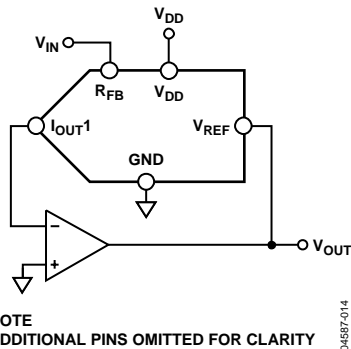

NOTE  
ADDITIONAL PINS OMITTED FOR CLARITY  
Figure 49. Current-Steering DAC Used as a Divider or Programmable Gain Element

However, if the DAC has a linearity specification of  $\pm 0.5$  LSB,  $D$  can have weight anywhere in the range of  $15.5/256$  to  $16.5/256$ . Therefore, the possible output voltage is in the range of  $15.5 V_{IN}$  to  $16.5 V_{IN}$ —an error of 3%, even though the DAC itself has a maximum error of 0.2%.

DAC leakage current is also a potential error source in divider circuits. The leakage current must be counterbalanced by an opposite current supplied from the op amp through the DAC. Because only a fraction,  $D$ , of the current in the  $V_{REF}$  terminal is routed to the  $I_{OUT1}$  terminal, the output voltage changes as follows:

$$\text{Output Error Voltage Due to Leakage} = (\text{Leakage} \times R)/D$$

where  $R$  is the DAC resistance at the  $V_{REF}$  terminal.

For a DAC leakage current of 10 nA,  $R = 10$  k $\Omega$ , and a gain (that is,  $1/D$ ) of 16, the error voltage is 1.6 mV.

## REFERENCE SELECTION

When selecting a reference for use with this series of current-output DACs, pay attention to the reference's output voltage temperature coefficient specification. This parameter not only affects the full-scale error, but also may affect the linearity (INL and DNL) performance. The reference temperature coefficient should be consistent with the system accuracy specifications. For example, an 8-bit system is required to hold its overall specification to within 1 LSB over the temperature range 0°C to 50°C, and the system's maximum temperature drift should be less than 78 ppm/°C.

A 12-bit system within 2 LSB accuracy requires a maximum drift of 10 ppm/°C. Choosing a precision reference with a low output temperature coefficient minimizes this error source. Table 7 lists some dc references available from Analog Devices that are suitable for use with this range of current-output DACs.

## AMPLIFIER SELECTION

The primary requirement for the current-steering mode is an amplifier with low input bias currents and low input offset voltage. The input offset voltage of an op amp is multiplied by the variable gain of the circuit due to the code-dependent output resistance of the DAC. A change in this noise gain between two adjacent digital fractions produces a step change in the output voltage due to the offset voltage of the amplifier's input. This output voltage change is superimposed on the desired change in output between the two codes and gives rise to a differential linearity error, which if large enough, could cause the DAC to be nonmonotonic.

The input bias current of an op amp generates an offset at the voltage output as a result of the bias current flowing in the feedback resistor,  $R_{FB}$ . Most op amps have input bias currents low enough to prevent significant errors in 12-bit applications. However, for 14-bit applications, some consideration should be given to selecting an appropriate amplifier.

Common-mode rejection of the op amp is important in voltage-switching circuits because it produces a code-dependent error at the voltage output of the circuit. Most op amps have adequate common-mode rejection for use at 8-, 10-, and 12-bit resolutions.

Provided that the DAC switches are driven from true wideband low impedance sources ( $V_{IN}$  and AGND), they settle quickly. Consequently, the slew rate and settling time of a voltage-switching DAC circuit is determined largely by the output op amp. To obtain minimum settling time in this configuration, it is important to minimize capacitance at the  $V_{REF}$  node (the voltage output node in this application) of the DAC. This is done by using low input-capacitance buffer amplifiers and careful board design.

Most single-supply circuits include ground as part of the analog signal range, which in turn requires an amplifier that can handle rail-to-rail signals. There is a large range of single-supply amplifiers available from Analog Devices.

Table 7. Suitable ADI Precision References

Part No.	Output Voltage (V)	Initial Tolerance (%)	Temp Drift (ppm/°C)	I <sub>SS</sub> (mA)	Output Noise (μV p-p)	Package
ADR01	10	0.05	3	1	20	SOIC-8
ADR01	10	0.05	9	1	20	TSOT-23, SC70
ADR02	5	0.06	3	1	10	SOIC-8
ADR02	5	0.06	9	1	10	TSOT-23, SC70
ADR03	2.5	0.10	3	1	6	SOIC-8
ADR03	2.5	0.10	9	1	6	TSOT-23, SC70
ADR06	3	0.10	3	1	10	SOIC-8
ADR06	3	0.10	9	1	10	TSOT-23, SC70
ADR431	2.5	0.04	3	0.8	3.5	SOIC-8
ADR435	5	0.04	3	0.8	8	SOIC-8
ADR391	2.5	0.16	9	0.12	5	TSOT-23
ADR395	5	0.10	9	0.12	8	TSOT-23

Table 8. Suitable ADI Precision Op Amps

Part No.	Supply Voltage (V)	V <sub>OS</sub> (Max) (μV)	I <sub>B</sub> (Max) (nA)	0.1 Hz to 10 Hz Noise (μV p-p)	Supply Current (μA)	Package
OP97	±2 to ±20	25	0.1	0.5	600	SOIC-8
OP1177	±2.5 to ±15	60	2	0.4	500	MSOP, SOIC-8
AD8551	2.7 to 5	5	0.05	1	975	MSOP, SOIC-8
AD8603	1.8 to 6	50	0.001	2.3	50	TSOT
AD8628	2.7 to 6	5	0.1	0.5	850	TSOT, SOIC-8

Table 9. Suitable ADI High Speed Op Amps

Part No.	Supply Voltage (V)	BW @ ACL (MHz)	Slew Rate (V/μs)	V <sub>OS</sub> (Max) (μV)	I <sub>B</sub> (Max) (nA)	Package
AD8065	5 to 24	145	180	1500	0.006	SOIC-8, SOT-23, MSOP
AD8021	±2.5 to ±12	490	120	1000	10500	SOIC-8, MSOP
AD8038	3 to 12	350	425	3000	750	SOIC-8, SC70-5
AD9631	±3 to ±6	320	1300	10000	7000	SOIC-8

**SERIAL INTERFACE**

The AD5450/AD5451/AD5452/AD5453 have an easy-to-use 3-wire interface that is compatible with SPI, QSPI, MICROWIRE, and most DSP interface standards. Data is written to the device in 16-bit words. This 16-bit word consists of two control bits and 8, 10, 12, or 14 data bits, as shown in Figure 50, Figure 51, Figure 52, and Figure 53. The AD5453 uses all 14 bits of DAC data, the AD5452 uses 12 bits and ignores the two LSBs, the AD5451 uses 10 bits and ignores the four LSBs, and the AD5450 uses 8 bits and ignores the six LSBs.

**DAC Control Bits C1, C0**

Control Bits C1 and C0 allow the user to load and update the new DAC code and to change the active clock edge. By default, the shift register clocks data upon the falling edge; this can be changed via the control bits. If changed, the DAC core is inoperative until the next data frame, and a power recycle is required to return it to active on the falling edge. A power cycle resets the core to default condition. On-chip power-on reset circuitry ensures that the device powers on with zero scale loaded to the DAC register and I<sub>OUT</sub> line.

**Table 10. DAC Control Bits**

C1	C0	Function Implemented
0	0	Load and update (power-on default)
0	1	Reserved
1	0	Reserved
1	1	Clock data to shift register upon rising edge

**SYNC Function**

SYNC is an edge-triggered input that acts as a frame-synchronization signal and chip enable. Data can only be transferred to the device while SYNC is low. To start the serial data transfer, SYNC should be taken low, observing the minimum SYNC falling to SCLK falling edge setup time, t<sub>s</sub>. To minimize the power consumption of the device, the interface powers up fully only when the device is being written to, that is, upon the falling edge of SYNC. The SCLK and SDIN input buffers are powered down upon the rising edge of SYNC.

After the falling edge of the 16<sup>th</sup> SCLK pulse, bring SYNC high to transfer data from the input shift register to the DAC register.

The serial interface to the AD5450 uses a 16-bit shift register. Take care to avoid incomplete data sequences as these will be latched to update the DAC output.

For example,

- Loading 0x3FFF (a complete data sequence) will update the output to 10 V (full scale).
- User intends to write 0x3200 but after 12 active edges SYNC goes high (incomplete write sequence). This will actually update the following code: 0xF200.
- The user expects an output of 5.6 V. However, if SYNC goes high after 12 valid clock edges then an incomplete data sequence of 12 bits is loaded. To complete the shift register the 4 LSBs from the previous sequence are taken and used as the 4 MSBs missing. The addition of these 4 bits will put the part in rising edge mode and the output will show no change. Figure 54, Figure 55, and Table 11 show the data frames for this example.

Also note that if more than 16-bits are loaded to the part before SYNC goes high the last 16-bits will be latched.

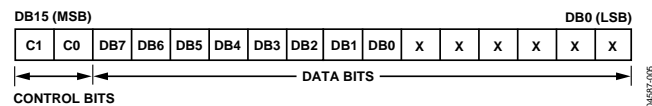

Figure 50. AD5450 8-Bit Input Shift Register Contents

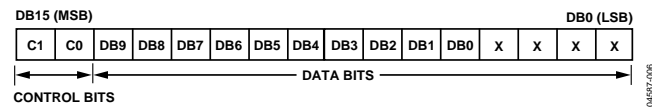

Figure 51. AD5451 10-Bit Input Shift Register Contents

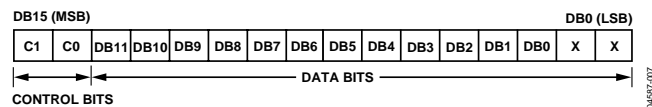

Figure 52. AD5452 12-Bit Input Shift Register Contents

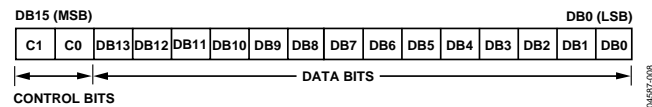

Figure 53. AD5453 14-Bit Input Shift Register Contents

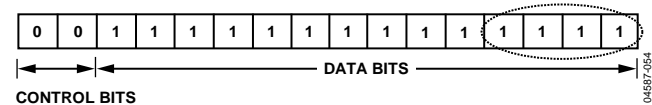

Figure 54. AD5453 First Write, Complete Data Sequence (0x3FFF)

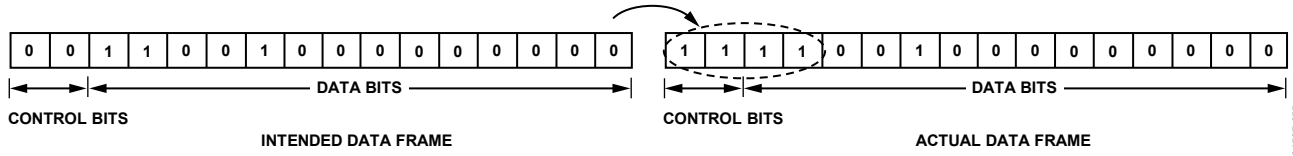

Figure 55. AD5453 Second Write, Incomplete Data Sequence (0x3200) and Subsequent Additional Bits (0xF200)

Table 11.

Writing Sequence	Data Write in Shift Register	Action Expected	Data Transfer to the Device	Action Carried Out
1	0x3FFF	Load and update 0x3FFF	0x3FFF	Load and update 0x3FFF
2	0x3200	Load and update 0x3200	0xF200	Clock data to shift register upon rising edge (0xF200)

## MICROPROCESSOR INTERFACING

Microprocessor interfacing to a [AD5450/AD5451/AD5452/AD5453](#) DAC is through a serial bus that uses standard protocol and is compatible with microcontrollers and DSP processors. The communication channel is a 3-wire interface consisting of a clock signal, a data signal, and a synchronization signal. The [AD5450/AD5451/AD5452/AD5453](#) require a 16-bit word, with the default being data valid upon the falling edge of SCLK, but this is changeable using the control bits in the data-word.

### ADSP-21xx-to-AD5450/AD5451/AD5452/AD5453 Interface

The ADSP-21xx family of DSPs is easily interfaced to a [AD5450/AD5451/AD5452/AD5453](#) DAC without the need for extra glue logic. Figure 56 is an example of an SPI interface between the DAC and the ADSP-2191M. SCK of the DSP drives the serial data line, SDIN. SYNC is driven from one of the port lines, in this case SPIxSEL.

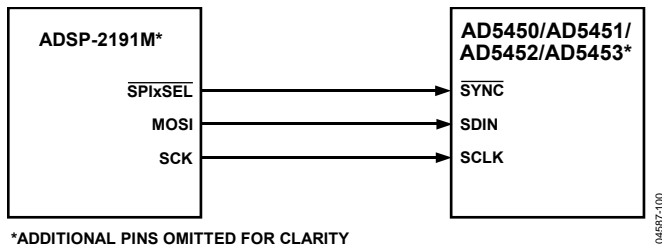
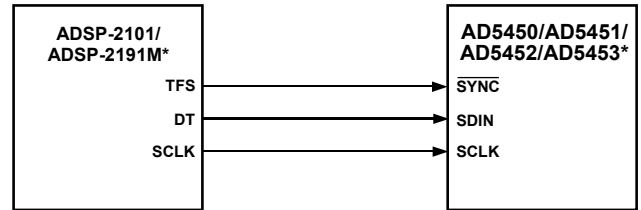

Figure 56. ADSP-2191M SPI-to-AD5450/AD5451/AD5452/AD5453 Interface

A serial interface between the DAC and DSP SPORT is shown in Figure 57. In this example, SPORT0 is used to transfer data to the DAC shift register. Transmission is initiated by writing a word to the Tx register after the SPORT has been enabled. In a write sequence, data is clocked out upon each rising edge of the DSP's serial clock and clocked into the DAC input shift register upon the falling edge of its SCLK. The update of the DAC output takes place upon the rising edge of the SYNC signal.



\*ADDITIONAL PINS OMITTED FOR CLARITY

Figure 57. ADSP-2101/ADSP-2191M-to-AD5450/AD5451/AD5452/AD5453 Interface

Communication between two devices at a given clock speed is possible when the following specifications are compatible: frame SYNC delay and frame SYNC setup-and-hold, data delay and data setup-and-hold, and SCLK width. The DAC interface expects a  $t_4$  (SYNC falling edge to SCLK falling edge setup time) of 13 ns minimum. See the *ADSP-21xx User Manual* for information on clock and frame SYNC frequencies for the SPORT register. Table 12 shows the setup for the SPORT control register.

Table 12. SPORT Control Register Setup

Name	Setting	Description
TFSW	1	Alternate framing
INVTFS	1	Active low frame signal
DTYPE	00	Right justify data
ISCLK	1	Internal serial clock
TFSR	1	Frame every word
ITFS	1	Internal framing signal
SLEN	1111	16-bit data-word

### ADSP-BF5xx-to-AD5450/AD5451/AD5452/AD5453 Interface

The ADSP-BF5xx family of processors has an SPI-compatible port that enables the processor to communicate with SPI-compatible devices. A serial interface between the BlackFin® processor and the [AD5450/AD5451/AD5452/AD5453](#) DAC is shown in Figure 58. In this configuration, data is transferred through the MOSI (master output, slave input) pin. SYNC is driven by the SPIxSEL pin, which is a reconfigured programmable flag pin.

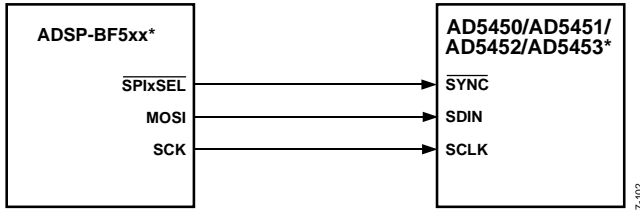

\*ADDITIONAL PINS OMITTED FOR CLARITY

Figure 58. ADSP-BF5xx-to-AD5450/AD5451/AD5452/AD5453 Interface

The ADSP-BF5xx processor incorporates channel synchronous serial ports (SPORT). A serial interface between the DAC and the DSP SPORT is shown in Figure 59. When the SPORT is enabled, initiate transmission by writing a word to the Tx register. The data is clocked out upon each rising edge of the DSP's serial clock and clocked into the DAC's input shift register upon the falling edge its SCLK. The DAC output is updated by using the transmit frame synchronization (TFS) line to provide a SYNC signal.

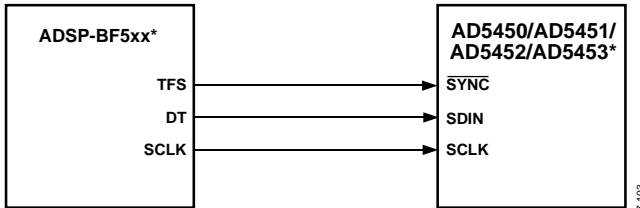

\*ADDITIONAL PINS OMITTED FOR CLARITY

Figure 59. ADSP-BF5xx SPORT-to-AD5450/AD5451/AD5452/AD5453 Interface

**80C51/80L51-to-AD5450/AD5451/AD5452/AD5453 Interface**

A serial interface between the DAC and the 80C51/80L51 is shown in Figure 60. TxD of the 80C51/80L51 drives SCLK of the DAC serial interface, and RxD drives the serial data line, SDIN. P1.1 is a bit-programmable pin on the serial port and is used to drive SYNC. As data is transmitted to the switch, P1.1 is taken low. The 80C51/80L51 transmit data only in 8-bit bytes; therefore, only eight falling clock edges occur in the transmit cycle.

To load data correctly to the DAC, P1.1 is left low after the first eight bits are transmitted, and a second write cycle is initiated to transmit the second byte of data. Data on RxD is clocked out of the microcontroller upon the rising edge of TxD and is valid upon the falling edge. As a result, no glue logic is required between the DAC and microcontroller interface. P1.1 is taken high following the completion of this cycle. The 80C51/80L51 provide the LSB of its SBUF register as the first bit in the data stream. The DAC input register acquires its data with the MSB as the first bit received. The transmit routine should take this into account.

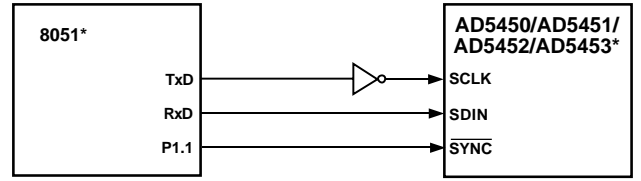

\*ADDITIONAL PINS OMITTED FOR CLARITY

Figure 60. 80C51/80L51-to-AD5450/AD5451/AD5452/AD5453 Interface

**MC68HC11-to-AD5450/AD5451/AD5452/AD5453 Interface**

Figure 61 is an example of a serial interface between the DAC and the MC68HC11 microcontroller. The serial peripheral interface (SPI) on the MC68HC11 is configured for master mode (MSTR) = 1, clock polarity bit (CPOL) = 0, and clock phase bit (CPHA) = 1. The SPI is configured by writing to the SPI control register (SPCR); see the 68HC11 User Manual. SCK of the 68HC11 drives the SCLK of the DAC interface; the MOSI output drives the serial data line (SDIN) of the DAC.

The SYNC signal is derived from a port line (PC7). When data is being transmitted to the AD5450/AD5451/AD5452/AD5453, the SYNC line is taken low (PC7). Data appearing on the MOSI output is valid upon the falling edge of SCK. Serial data from the 68HC11 is transmitted in 8-bit bytes with only eight falling clock edges occurring in the transmit cycle. Data is transmitted MSB first. To load data to the DAC, PC7 is left low after the first eight bits are transferred, and a second serial write operation is performed to the DAC. PC7 is taken high at the end of this procedure.

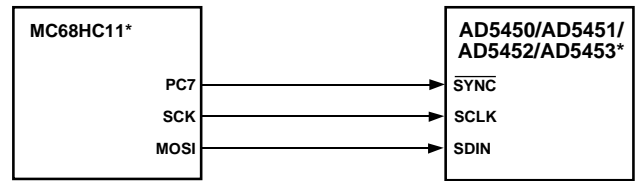

\*ADDITIONAL PINS OMITTED FOR CLARITY

Figure 61. MC68HC11-to-AD5450/AD5451/AD5452/AD5453 Interface

If the user wants to verify the data previously written to the input shift register, the SDO line can be connected to MISO of the MC68HC11. In this configuration with SYNC low, the shift register clocks data out upon the rising edges of SCLK.

### MICROWIRE-to-AD5450/AD5451/AD5452/AD5453 Interface

Figure 62 shows an interface between the DAC and any MICROWIRE-compatible device. Serial data is shifted out upon the falling edge of the serial clock, SK, and is clocked into the DAC input shift register upon the rising edge of SK, which corresponds to the falling edge of the DAC's SCLK.

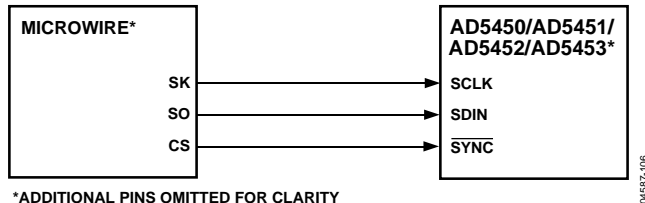

Figure 62. MICROWIRE-to-AD5450/AD5451/AD5452/AD5453 Interface

### PIC16C6x/PIC16C7x-to-AD5450/AD5451/AD5452/AD5453 Interface

The PIC16C6x/PIC16C7x synchronous serial port (SSP) is configured as an SPI master with the clock polarity bit (CKP) = 0. This is done by writing to the synchronous serial port control register (SSPCON); see the *PIC16/PIC17 Microcontroller User Manual*.

In this example, I/O Port RA1 is used to provide a SYNC signal and enable the serial port of the DAC. This microcontroller transfers only eight bits of data during each serial transfer operation; therefore, two consecutive write operations are required. Figure 63 shows the connection diagram.

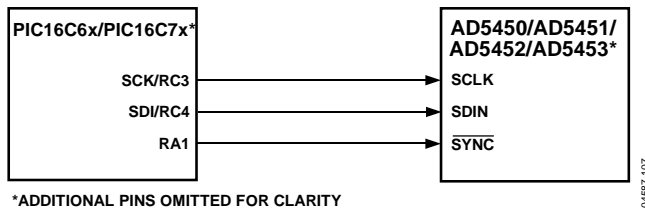

Figure 63. PIC16C6x/7x-to-AD5450/AD5451/AD5452/AD5453 Interface

### PCB LAYOUT AND POWER SUPPLY DECOUPLING

In any circuit where accuracy is important, careful consideration of the power supply and ground return layout helps to ensure the rated performance. The printed circuit board on which a [AD5450/AD5451/AD5452/AD5453](#) DAC is mounted should be designed so that the analog and digital sections are separated and confined to certain areas of the board. If the DAC is in a system where multiple devices require an AGND-to-DGND connection, the connection should be made at one point only. The star ground point should be established as close as possible to the device.

These DACs should have ample supply bypassing of 10  $\mu\text{F}$  in parallel with 0.1  $\mu\text{F}$  on the supply located as close to the package as possible, ideally right up against the device. The 0.1  $\mu\text{F}$  capacitor should have low effective series resistance (ESR) and low effective series inductance (ESI), like the common ceramic types that provide a low impedance path to ground at high frequencies, to handle transient currents due to internal logic switching. Low ESR 1  $\mu\text{F}$  to 10  $\mu\text{F}$  tantalum or electrolytic capacitors should also be applied at the supplies to minimize transient disturbance and filter out low frequency ripple.

Components, such as clocks, that produce fast switching signals should be shielded with a digital ground to avoid radiating noise to other parts of the board, and they should never be run near the reference inputs.

Avoid crossover of digital and analog signals. Traces on opposite sides of the board should run at right angles to each other. This reduces the effects of feedthrough through the board. A microstrip technique is the best solution, but its use is not always possible with a double-sided board. In this technique, the component side of the board is dedicated to the ground plane and signal traces are placed on the solder side.

It is good practice to employ compact, minimum lead length PCB layout design. Leads to the input should be as short as possible to minimize IR drops and stray inductance.

The PCB metal traces between  $V_{\text{REF}}$  and  $R_{\text{FB}}$  should also be matched to minimize gain error. To optimize high frequency performance, the I-to-V amplifier should be located as close to the device as possible.

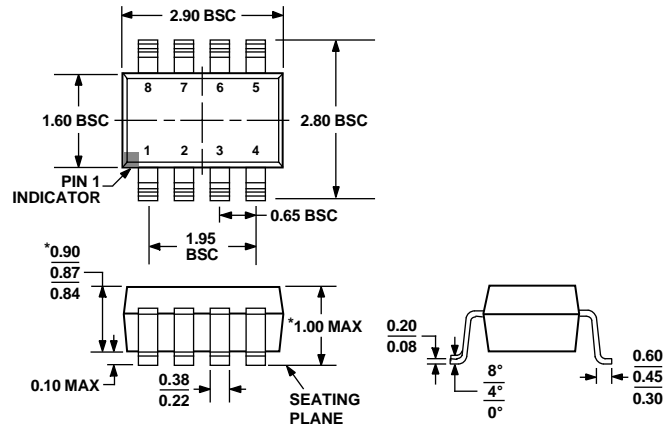

Table 13. Overview of AD54xx and AD55xx Devices

Part No.	Resolution	No. DACs	INL (LSB)	Interface	Package <sup>1</sup>	Features
AD5424	8	1	±0.25	Parallel	RU-16, CP-20	10 MHz BW, 17 ns $\overline{CS}$ pulse width
AD5426	8	1	±0.25	Serial	RM-10	10 MHz BW, 50 MHz serial
AD5428	8	2	±0.25	Parallel	RU-20	10 MHz BW, 17 ns $\overline{CS}$ pulse width
AD5429	8	2	±0.25	Serial	RU-10	10 MHz BW, 50 MHz serial
AD5450	8	1	±0.25	Serial	UJ-8	12 MHz BW, 50 MHz serial interface
AD5432	10	1	±0.5	Serial	RM-10	10 MHz BW, 50 MHz serial
AD5433	10	1	±0.5	Parallel	RU-20, CP-20	10 MHz BW, 17 ns $\overline{CS}$ pulse width
AD5439	10	2	±0.5	Serial	RU-16	10 MHz BW, 50 MHz serial
AD5440	10	2	±0.5	Parallel	RU-24	10 MHz BW, 17 ns $\overline{CS}$ pulse width
AD5451	10	1	±0.25	Serial	UJ-8	12 MHz BW, 50 MHz serial interface
AD5443	12	1	±1	Serial	RM-10	10 MHz BW, 50 MHz serial
AD5444	12	1	±0.5	Serial	RM-10	12 MHz BW, 50 MHz serial
AD5415	12	2	±1	Serial	RU-24	10 MHz BW, 50 MHz serial
AD5405	12	2	±1	Parallel	CP-40	10 MHz BW, 17 ns $\overline{CS}$ pulse width
AD5445	12	2	±1	Parallel	RU-20, CP-20	10 MHz BW, 17 ns $\overline{CS}$ pulse width
AD5447	12	2	±1	Parallel	RU-24	10 MHz BW, 17 ns $\overline{CS}$ pulse width
AD5449	12	2	±1	Serial	RU-16	10 MHz BW, 50 MHz serial
AD5452	12	1	±0.5	Serial	UJ-8, RM-8	12 MHz BW, 50 MHz serial interface
AD5446	14	1	±1	Serial	RM-10	12 MHz BW, 50 MHz serial
AD5453	14	1	±2	Serial	UJ-8, RM-8	12 MHz BW, 50 MHz serial
AD5553	14	1	±1	Serial	RM-8	4 MHz BW, 50 MHz serial clock
AD5556	14	1	±1	Parallel	RU-28	4 MHz BW, 20 ns $\overline{WR}$ pulse width
AD5555	14	2	±1	Serial	RM-8	4 MHz BW, 50 MHz serial clock
AD5557	14	2	±1	Parallel	RU-38	4 MHz BW, 20 ns $\overline{WR}$ pulse width
AD5543	16	1	±2	Serial	RM-8	4 MHz BW, 50 MHz serial clock
AD5546	16	1	±2	Parallel	RU-28	4 MHz BW, 20 ns $\overline{WR}$ pulse width
AD5545	16	2	±2	Serial	RU-16	4 MHz BW, 50 MHz serial clock
AD5547	16	2	±2	Parallel	RU-38	4 MHz BW, 20 ns $\overline{WR}$ pulse width

<sup>1</sup> RU = TSSOP, CP = LFCSP, RM = MSOP, UJ = TSOT.

OUTLINE DIMENSIONS



\*COMPLIANT TO JEDEC STANDARDS MO-193-BA WITH THE EXCEPTION OF PACKAGE HEIGHT AND THICKNESS.

Figure 64. 8-Lead Thin Small Outline Transistor Package [TSOT] (UJ-8)

Dimensions shown in millimeters

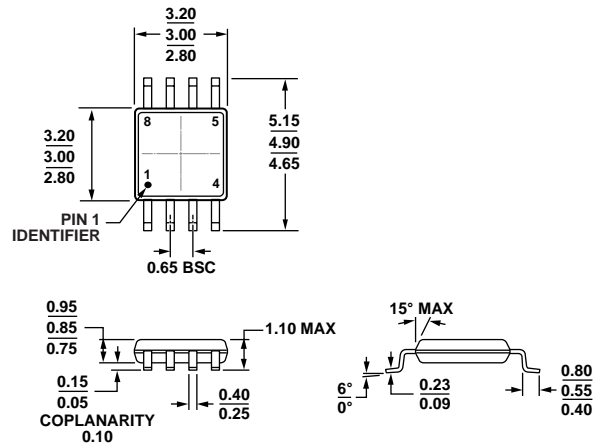

COMPLIANT TO JEDEC STANDARDS MO-187-AA

Figure 65. 8-Lead Mini Small Outline Package [MSOP] (RM-8)

Dimensions shown in millimeters

10-07-2008-B

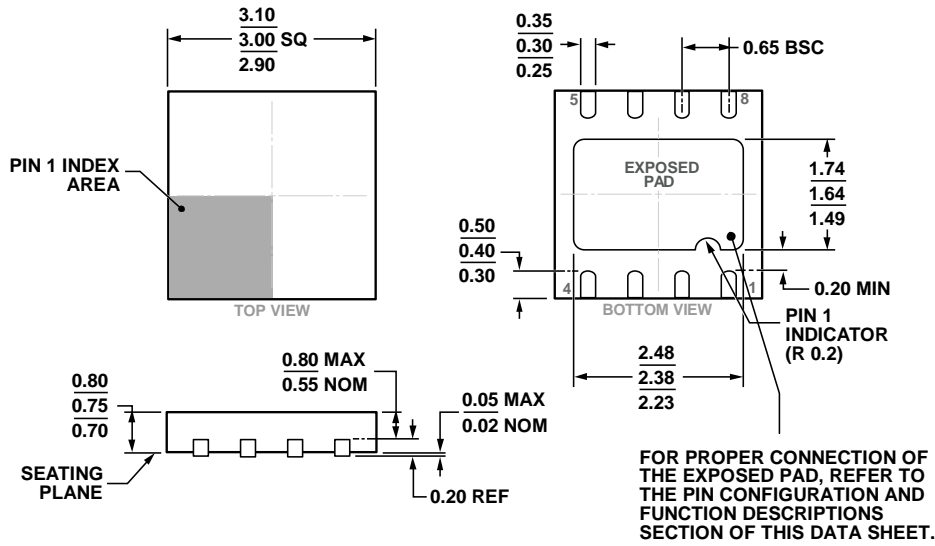

Figure 66. 8-Lead Lead Frame Chip Scale Package [LFCS\_P\_WD]  
 3 mm × 3 mm Body, Very Very Thin, Dual Lead  
 (CP-8-3)  
 Dimensions shown in millimeters

02-05-2013-C

**ORDERING GUIDE**

Model <sup>1, 2</sup>	Resolution	INL	Temperature Range	Package Description	Package Option	Branding
AD5450YUJZ-REEL	8	±0.25	-40°C to +125°C	8-Lead TSOT	UJ-8	D6Y
AD5450YUJZ-REEL7	8	±0.25	-40°C to +125°C	8-Lead TSOT	UJ-8	D6Y
AD5451YUJZ-REEL	10	±0.25	-40°C to +125°C	8-Lead TSOT	UJ-8	D6Z
AD5451YUJZ-REEL7	10	±0.25	-40°C to +125°C	8-Lead TSOT	UJ-8	D6Z
AD5452YUJZ-REEL	12	±0.5	-40°C to +125°C	8-Lead TSOT	UJ-8	D70
AD5452YUJZ-REEL7	12	±0.5	-40°C to +125°C	8-Lead TSOT	UJ-8	D70
AD5452YRM	12	±0.5	-40°C to +125°C	8-Lead MSOP	RM-8	D1Z
AD5452YRM-REEL	12	±0.5	-40°C to +125°C	8-Lead MSOP	RM-8	D1Z
AD5452YRMZ	12	±0.5	-40°C to +125°C	8-Lead MSOP	RM-8	D70
AD5452YRMZ-REEL	12	±0.5	-40°C to +125°C	8-Lead MSOP	RM-8	D70
AD5452YRMZ-REEL7	12	±0.5	-40°C to +125°C	8-Lead MSOP	RM-8	D70
AD5453WBCPZ-RL	14	±2	-40°C to +125°C	8-Lead LFCS_P_WD	CP-8-3	DG3
AD5453YUJZ-REEL	14	±2	-40°C to +125°C	8-Lead TSOT	UJ-8	DAH
AD5453YUJZ-REEL7	14	±2	-40°C to +125°C	8-Lead TSOT	UJ-8	DAH
AD5453YRM	14	±2	-40°C to +125°C	8-Lead MSOP	RM-8	D26
AD5453YRM-REEL	14	±2	-40°C to +125°C	8-Lead MSOP	RM-8	D26
AD5453YRM-REEL7	14	±2	-40°C to +125°C	8-Lead MSOP	RM-8	D26
AD5453YRMZ	14	±2	-40°C to +125°C	8-Lead MSOP	RM-8	DAH
AD5453YRMZ-REEL	14	±2	-40°C to +125°C	8-Lead MSOP	RM-8	DAH
AD5453YRMZ-REEL7	14	±2	-40°C to +125°C	8-Lead MSOP	RM-8	DAH
EV-AD5443/46/53SDZ				Evaluation Board		

<sup>1</sup> Z = RoHS Compliant Part.  
<sup>2</sup> W = Qualified for Automotive Applications.

**AUTOMOTIVE PRODUCTS**

The AD5453WBCPZ-RL model is available with controlled manufacturing to support the quality and reliability requirements of automotive applications. Note that this automotive model may have specifications that differ from the commercial models; therefore, designers should review the Specifications section of this data sheet carefully. Only the automotive grade products shown are available for use in automotive applications. Contact your local Analog Devices account representative for specific product ordering information and to obtain the specific Automotive Reliability reports for these models.

**NOTES**