



FEATURES

- UL60950 recognized
- Operation to zero load
- Single isolated output
- 1kVDC isolation
- Efficiency up to 87% typical
- Wide temperature performance at full 1 watt load, -40°C to 85°C
- Power density from 1.305W/cm³
- Industry standard pinout
- 3.3V, 5V, 12V, 15V & 24V input
- 3.3V, 5V, 9V, 12V and 15V output
- Custom solutions available
- Pin compatible with LME, NME, NKE & NML series
- PCB mounting

DESCRIPTION

The MEE1 series is the new high performance version of our 1W NME series. The MEE1 series is more efficient and offers improved regulation performance for applications where a wide output voltage variation can not be tolerated. They are ideally suited for providing local supplies on control system boards with the added benefit of 1kVDC galvanic isolation to reduce switching noise.

SELECTION GUIDE

Order Code	Nominal Input Voltage	Output Voltage	Output Current	Load Regulation (Typ)	Load Regulation (Max)	Ripple & Noise (Typ)	Ripple & Noise (Max)	Input Current at Rated Load	Efficiency (Min)	Efficiency (Typ)	Isolation Capacitance (Typ)	MTTF	Package Style
	V	V	mA	%	%	mVp-p	mVp-p	mA	%	%	pF	kHrs	
MEE1S0303SC	3.3	3.3	303	10	12	26	50	377	76	78.5	42	3852	SIP
MEE1S0305SC	3.3	5	200	9.2	11	23	50	360	79	81.5	44	4008	
MEE1S0309SC	3.3	9	111	10	12	15	40	361	79	81.5	47	4930	
MEE1S0312SC	3.3	12	83	8.7	11	14	40	352	81	84	48	4040	
MEE1S0315SC	3.3	15	67	7.8	10	12	35	350	82	84.5	50	3792	
MEE1S0503SC	5	3.3	303	8	10	22	45	246	76	80	39	3213	
MEE1S0505SC	5	5	200	5.6	7	19	40	237	80	83	46	3990	
MEE1S0509SC	5	9	111	6.8	9	13	35	238	80	83.5	53	4526	
MEE1S0512SC	5	12	83	6.5	8	11	35	233	81	85	49	3756	
MEE1S0515SC	5	15	67	5.7	8	9	30	230	83	85.5	46	3240	
MEE1S1205SC	12	5	200	5	7	16	40	97	79	83.5	47	3857	
MEE1S1209SC	12	9	111	5.8	8	12	35	97	79	84	77	4370	
MEE1S1212SC	12	12	83	4.8	6	10	35	97	82	85	79	3774	
MEE1S1215SC	12	15	67	4.2	7	9	35	95	81	86.5	81	3779	
MEE1S1505SC	15	5	200	4.2	6	15	40	79	77	83.5	41	3312	
MEE1S1509SC	15	9	111	5.1	7	12	35	79	77	83	65	3451	
MEE1S1512SC	15	12	83	4.3	5	11	35	77	78	85	77	3940	
MEE1S1515SC	15	15	67	3.8	5	8	30	76	83	86.5	100	3420	
MEE1S2405SC	24	5	200	3.6	5	19	50	49	75	83	51	3983	
MEE1S2409SC	24	9	111	4	6	17	40	50	74	83	70	4255	
MEE1S2412SC	24	12	83	3.4	5	11	35	49	79	85.5	89	3991	
MEE1S2415SC	24	15	67	3	5	9	35	49	78	86	101	3532	
MEE1S0303DC	3.3	3.3	303	10	12	26	50	377	76	78.5	42	3852	DIP
MEE1S0305DC	3.3	5	200	9.2	11	23	50	360	79	81.5	44	4008	
MEE1S0309DC	3.3	9	111	10	12	15	40	361	79	81.5	47	4930	
MEE1S0312DC	3.3	12	83	8.7	11	14	40	352	81	84	48	4040	
MEE1S0315DC	3.3	15	67	7.8	10	12	35	350	82	84.5	50	3792	
MEE1S0503DC	5	3.3	303	8	10	22	45	246	76	80	39	3213	
MEE1S0505DC	5	5	200	5.6	7	19	40	237	80	83	46	3990	
MEE1S0509DC	5	9	111	6.8	9	13	35	238	80	83.5	53	4526	
MEE1S0512DC	5	12	83	6.5	8	11	35	233	81	85	49	3756	
MEE1S0515DC	5	15	67	5.7	8	9	30	230	83	85.5	46	3240	
MEE1S1205DC	12	5	200	5	7	16	40	97	79	83.5	47	3857	
MEE1S1209DC	12	9	111	5.8	8	12	35	97	79	84	77	4370	
MEE1S1212DC	12	12	83	4.8	6	10	35	97	82	85	79	3774	
MEE1S1215DC	12	15	67	4.2	7	9	35	95	81	86.5	81	3779	
MEE1S1505DC	15	5	200	4.2	6	15	40	79	77	83.5	41	3312	
MEE1S1509DC	15	9	111	5.1	7	12	35	79	77	83	65	3451	
MEE1S1512DC	15	12	83	4.3	5	11	35	77	78	85	77	3940	
MEE1S1515DC	15	15	67	3.8	5	8	30	76	83	86.5	100	3420	
MEE1S2405DC	24	5	200	3.6	5	19	50	49	75	83	51	3983	
MEE1S2409DC	24	9	111	4	6	17	40	50	74	83	70	4255	
MEE1S2412DC	24	12	83	3.4	5	11	35	49	79	85.5	89	3991	
MEE1S2415DC	24	15	67	3	5	9	35	49	78	86	101	3532	

1. Calculated using MIL-HDBK-217F FN2 with nominal input voltage at full load.

All specifications typical at TA=25°C, nominal input voltage and rated output current unless otherwise specified.



INPUT CHARACTERISTICS					
Parameter	Conditions	Min.	Typ.	Max.	Units
Voltage range	Continuous operation, 3.3V input types	2.97	3.3	3.63	V
	Continuous operation, 5V input types	4.5	5.0	5.5	
	Continuous operation, 12V input types	10.8	12.0	13.2	
	Continuous operation, 15V input types	13.5	15	16.5	
	Continuous operation, 24V input types	21.6	24	26.4	
Reflected ripple current	3.3V, 5V & 12V Input types		5	20	mA p-p
	15V Input types		3	10	
	24V Input types		4	10	

OUTPUT CHARACTERISTICS					
Parameter	Conditions	Min.	Typ.	Max.	Units
Rated Power	T _A =-40°C to 85°C			1.0	W
Voltage Set Point Accuracy	See tolerance envelope				
Line regulation	High V _{IN} to low V _{IN}	3.3V Input	1.0	1.15	%/%
		All other inputs	1.0	1.1	

ISOLATION CHARACTERISTICS					
Parameter	Conditions	Min.	Typ.	Max.	Units
Isolation test voltage	Flash tested for 1 second	1000			VDC
Resistance	Viso= 1000VDC	10			GΩ

GENERAL CHARACTERISTICS					
Parameter	Conditions	Min.	Typ.	Max.	Units
Switching frequency	3.3V input types		47		kHz
	5V input types		60		
	12V input types		70		
	15V input types		77		
	24V input types		80		

TEMPERATURE CHARACTERISTICS					
Parameter	Conditions	Min.	Typ.	Max.	Units
Specification	All output types	-40		85	°C
Storage		-50		125	
Case Temperature above ambient	MEE1S0303XC			30	
	All other types			25	
Cooling	Free air convection				

ABSOLUTE MAXIMUM RATINGS	
Lead temperature 1.5mm from case for 10 seconds	260°C
Internal power dissipation	450mW
Input voltage V _{IN} , MEE1S03 types	5.5V
Input voltage V _{IN} , MEE1S05 types	7V
Input voltage V _{IN} , MEE1S12 types	15V
Input voltage V _{IN} , MEE1S15 types	18V
Input voltage V _{IN} , MEE1S24 types	28V

All specifications typical at T_A=25°C, nominal input voltage and rated output current unless otherwise specified.

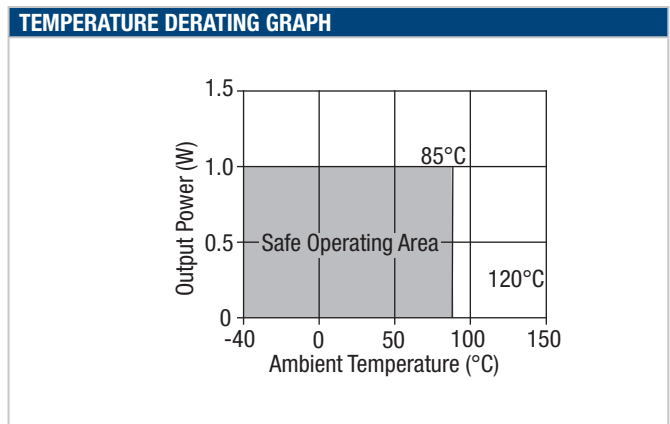

TOLERANCE ENVELOPES

The voltage tolerance envelopes show typical load regulation characteristics for this product series. The tolerance envelope is the maximum output voltage variation due to changes in output loading and set point accuracy.

3.3V Input & 0503

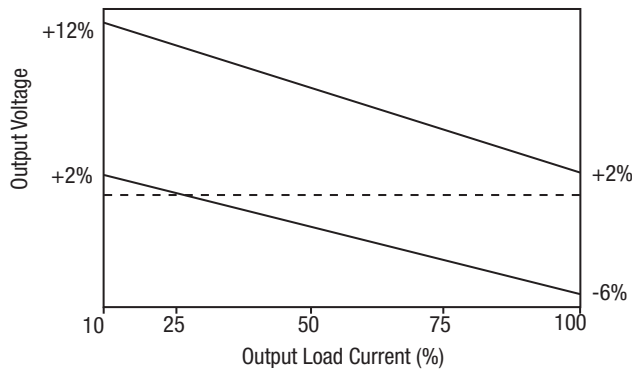

5V Output

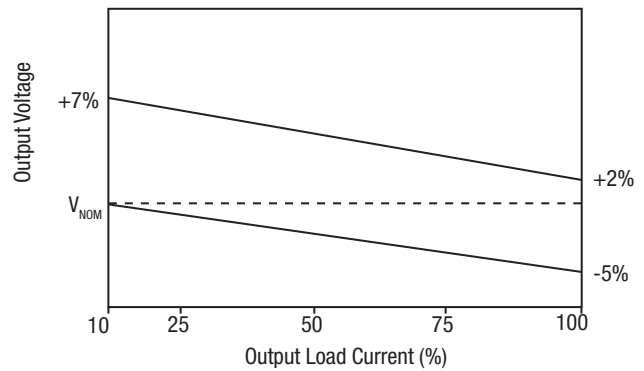

9V Output

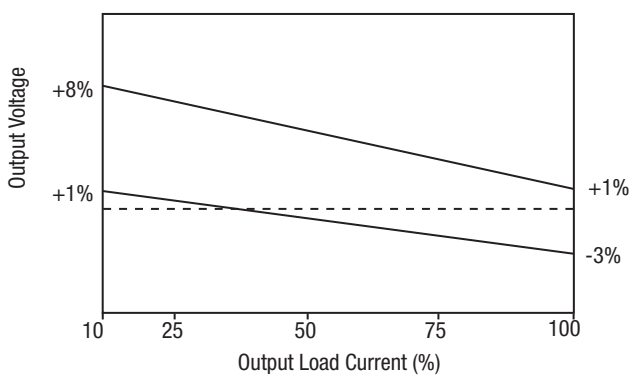

12V Output

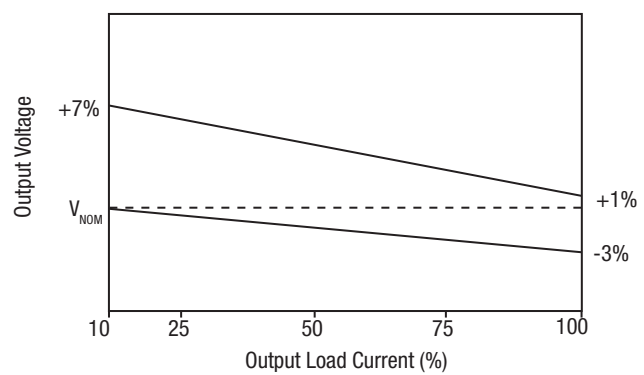

15V Output

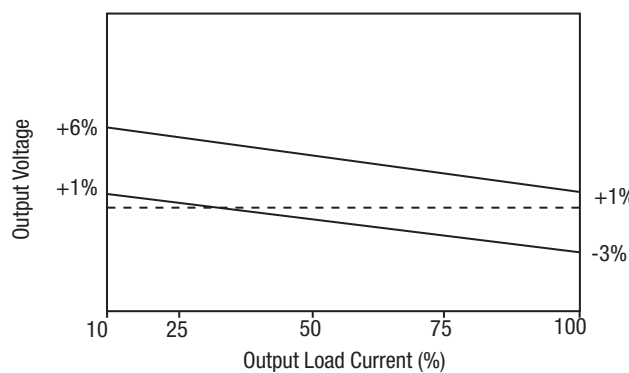

RoHS COMPLIANCE INFORMATION



This series is compatible with RoHS soldering systems with a peak wave solder temperature of 260°C for 10 seconds. The pin termination finish on the SIP package type is Tin Plate, Hot Dipped over Matte Tin with Nickel Preplate. The DIP types are Matte Tin over Nickel Preplate. Both types in this series are backward compatible with Sn/Pb soldering systems.

For further information, please visit www.murata-ps.com/rohs

EFFICIENCY VS LOAD

3.3V Input

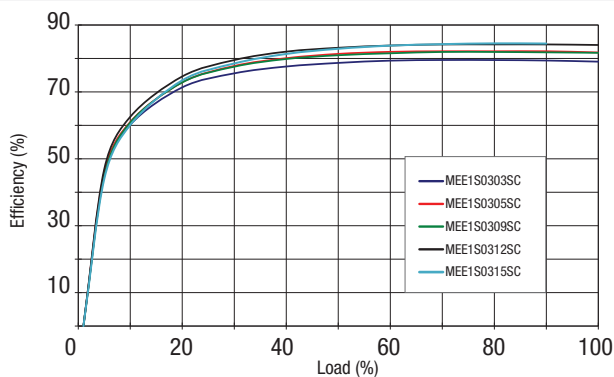

5V Input

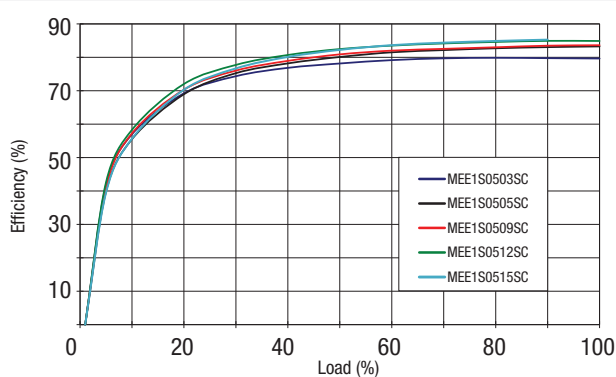

12V Input

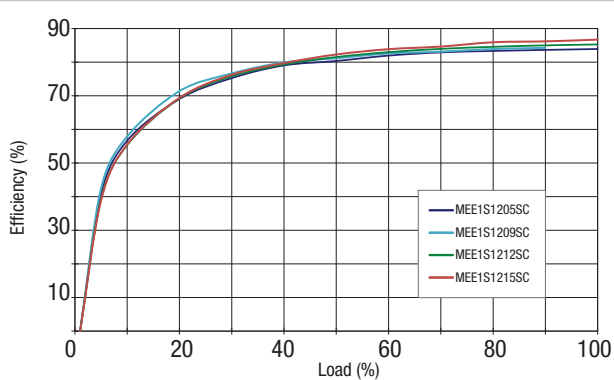

15V Input

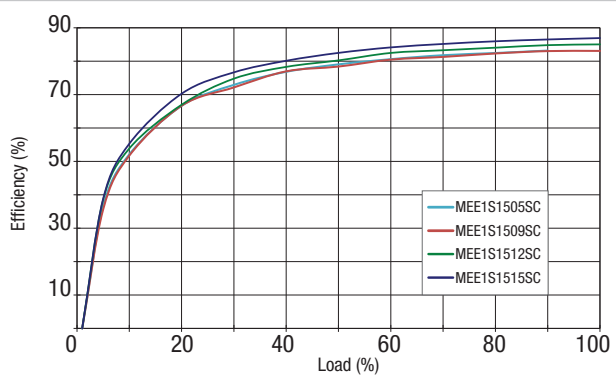

24V Input

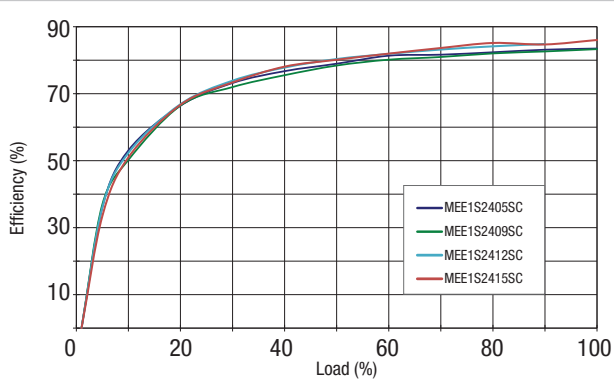

APPLICATION NOTES

Minimum Load

The minimum load to meet datasheet specification is 10% of the full rated load across the specified input voltage range. Lower than 10% minimum loading will result in an increase in output voltage, which may rise to typically 1.25 times the specified output voltage if the output load falls to less than 5%.

Capacitive loading and start up

Typical start up times for this series, with a typical input voltage rise time of 2.2µs and output capacitance of 10µF, are shown in the table below. The product series will start into a capacitance of 47µF with an increased start time, however, the maximum recommended output capacitance is 10µF.

	Start-up time		Start-up time
	µs		µs
MEE1S0303XC	355	MEE1S1209XC	818
MEE1S0305XC	622	MEE1S1212XC	1285
MEE1S0309XC	1542	MEE1S1215XC	2052
MEE1S0312XC	2410	MEE1S1505XC	260
MEE1S0315XC	3346	MEE1S1509XC	642
MEE1S0503XC	334	MEE1S1512XC	993
MEE1S0505XC	402	MEE1S1515XC	1574
MEE1S0509XC	1316	MEE1S2405XC	221
MEE1S0512XC	1776	MEE1S2409XC	541
MEE1S0515XC	2232	MEE1S2412XC	860
MEE1S1205XC	285	MEE1S2415XC	1049

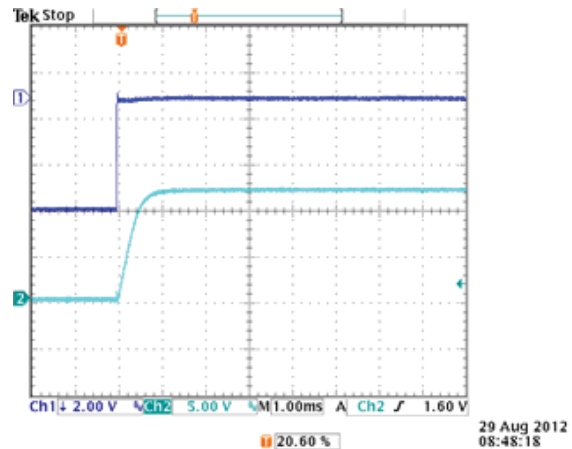

Ripple & Noise Characterisation Method

Ripple and noise measurements are performed with the following test configuration.

C1	1µF X7R multilayer ceramic capacitor, voltage rating to be a minimum of 3 times the output voltage of the DC/DC converter
C2	10µF tantalum capacitor, voltage rating to be a minimum of 1.5 times the output voltage of the DC/DC converter with an ESR of less than 100mΩ at 100 kHz
C3	100nF multilayer ceramic capacitor, general purpose
R1	450Ω resistor, carbon film, ±1% tolerance
R2	50Ω BNC termination
T1	3T of the coax cable through a ferrite toroid
RLOAD	Resistive load to the maximum power rating of the DC/DC converter. Connections should be made via twisted wires

Measured values are multiplied by 10 to obtain the specified values.

Differential Mode Noise Test Schematic

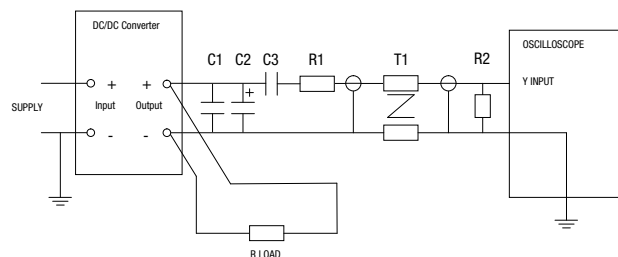

TECHNICAL NOTES

ISOLATION VOLTAGE

'Hi Pot Test', 'Flash Tested', 'Withstand Voltage', 'Proof Voltage', 'Dielectric Withstand Voltage' & 'Isolation Test Voltage' are all terms that relate to the same thing, a test voltage, applied for a specified time, across a component designed to provide electrical isolation, to verify the integrity of that isolation.

Murata Power Solutions MEE1 series of DC/DC converters are all 100% production tested at their stated isolation voltage. This is 1kVDC for 1 second.

A question commonly asked is, "What is the continuous voltage that can be applied across the part in normal operation?"

The MEE1 has been recognized by Underwriters Laboratory for functional insulation, both input and output should normally be maintained within SELV limits i.e. less than 42.4V peak, or 60VDC. The isolation test voltage represents a measure of immunity to transient voltages and the part should never be used as an element of a safety isolation system. The part could be expected to function correctly with several hundred volts off-set applied continuously across the isolation barrier; but then the circuitry on both sides of the barrier must be regarded as operating at an unsafe voltage and further isolation/insulation systems must form a barrier between these circuits and any user-accessible circuitry according to safety standard requirements.

REPEATED HIGH-VOLTAGE ISOLATION TESTING

It is well known that repeated high-voltage isolation testing of a barrier component can actually degrade isolation capability, to a lesser or greater degree depending on materials, construction and environment. The MEE1 series has toroidal isolation transformers, with no additional insulation between primary and secondary windings of enameled wire. While parts can be expected to withstand several times the stated test voltage, the isolation capability does depend on the wire insulation. Any material, including this enamel (typically polyurethane) is susceptible to eventual chemical degradation when subject to very high applied voltages thus implying that the number of tests should be strictly limited. We therefore strongly advise against repeated high voltage isolation testing, but if it is absolutely required, that the voltage be reduced by 20% from specified test voltage.

This consideration equally applies to agency recognized parts rated for better than functional isolation where the wire enamel insulation is always supplemented by a further insulation system of physical spacing or barriers.

PACKAGE SPECIFICATIONS

MECHANICAL DIMENSIONS

DIP Package

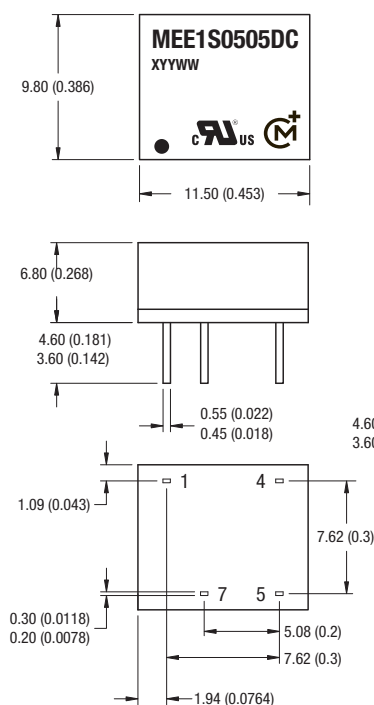

SIP Package

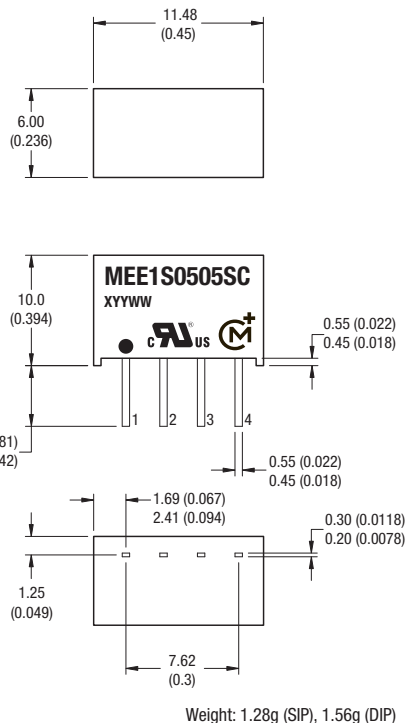

Weight: 1.28g (SIP), 1.56g (DIP)

All dimensions in mm ±0.25mm (inches ±0.01). All pins on a 2.54 (0.1) pitch and within ± 0.25 (0.01) of true position.

PIN CONNECTIONS - 8 PIN DIP

Pin	Function
1	-VIN
4	+VIN
5	+VOUT
7	-VOUT

PIN CONNECTIONS - 4 PIN SIP

Pin	Function
1	-VIN
2	+VIN
3	-VOUT
4	+VOUT

PACKAGE SPECIFICATIONS (continued)

RECOMMENDED FOOTPRINT DETAILS

8 Pin DIP Package

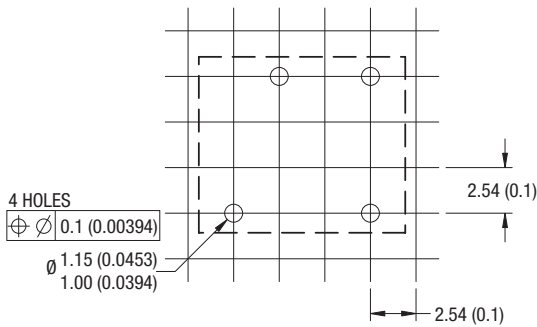

4 Pin SIP Package

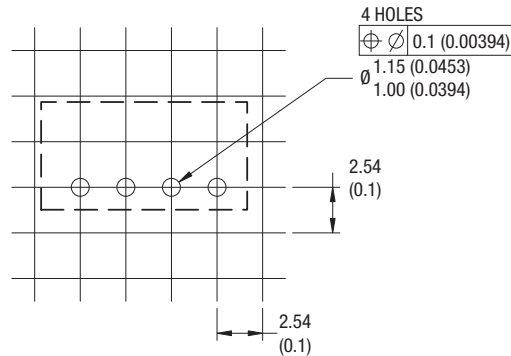

TUBE OUTLINE DIMENSIONS

8 Pin DIP Tube

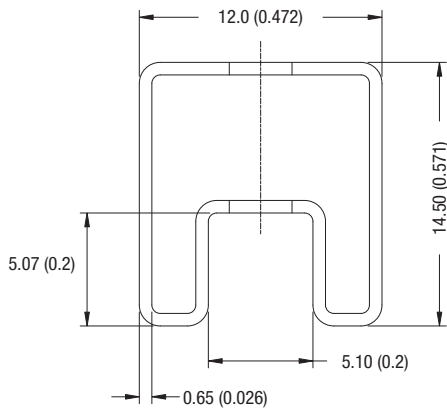

4 Pin SIP Tube

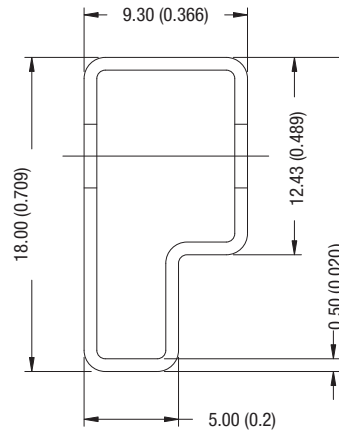

Unless otherwise stated all dimensions in mm (inches) ± 0.5 mm.
 Tube length (8 Pin DIP) : 520mm ± 2 mm (20.47).
 Tube length (4 Pin SIP) : 520mm ± 2 mm (20.47).

Tube Quantity : 35

SAFETY APPROVAL

The MEE1 series has been recognized by Underwriters Laboratory (UL) to UL 60950 for functional insulation in a maximum ambient temperature for 3.3V & 5V input models of 60°C and for 12V, 15V and 24V models of 85°C. File number E151252 applies. The MEE1 Series of converters are not internally fused so to meet the requirements of UL 60950 an anti-surge input line fuse should always be used with ratings as defined below.

- MEE1S03xxxC: 1A
- MEE1S05xxxC: 0.7A
- MEE1S12xxxC: 0.2A
- MEE1S15xxxC: 0.2A
- MEE1S24xxxC: 0.16A

All fuses should be UL approved and rated to at least the maximum allowable DC input voltage.

Murata Power Solutions, Inc.
 11 Cabot Boulevard, Mansfield, MA 02048-1151 U.S.A.
 ISO 9001 and 14001 REGISTERED



**This product is subject to the following operating requirements and the Life and Safety Critical Application Sales Policy:
 Refer to: <http://www.murata-ps.com/requirements/>**

Murata Power Solutions, Inc. makes no representation that the use of its products in the circuits described herein, or the use of other technical information contained herein, will not infringe upon existing or future patent rights. The descriptions contained herein do not imply the granting of licenses to make, use, or sell equipment constructed in accordance therewith. Specifications are subject to change without notice.
 © 2012 Murata Power Solutions, Inc.