

# Triple 7.0 mOhm and Dual 17 mOhm High Side Switch

The 07XSF517 is the latest achievement in DC motors and lighting drivers. It belongs to an expanding family to control and diagnose various types of loads, such as incandescent lamps or light-emitting diodes (LEDs) with enhanced precision. It combines flexibility through daisy chainable SPI 5.0 MHz, extended digital and analog feedbacks, safety, and robustness.

Output edge shaping helps to improve electromagnetic performance. To avoid shutting off the device upon inrush current, while still being able to closely track the load current, a dynamic overcurrent threshold profile is featured. Current of each channel can be sensed with a programmable sensing ratio. Whenever communication with the external microcontroller is lost, the device enters a Fail operation mode, but remains operational, controllable, and protected.

This new generation of high side switch products family facilitates ECU design due to compatible MCU software and PCB foot prints for each device variant.

This family is packaged in a Pb-free power-enhanced SOIC package with an exposed pad, which is End of Life Vehicles directive compliant. This device is powered by SMARTMOS technology.

## Features

- Triple 7.0 mΩ and dual 17 mΩ high side switches with high transient current capability
- 16-bit 5.0 MHz SPI control of overcurrent profiles, channel control including PWM duty-cycles, output-ON and -OFF OpenLoad detections, thermal shut-down and prewarning, and fault reporting
- Output current monitoring with programmable synchronization signal and supply voltage feedback
- Limp Home mode
- External smart power switch control
- Operating voltage is 7.0 to 18 V with sleep current < 5.0 μA, extended mode from 6.0 to 28 V
- -16 V reverse polarity and ground disconnect protections
- Compatible PCB foot print and SPI software driver among the family



## Applications

- Low voltage exterior lighting
- Low voltage industrial lighting
- Low voltage automation systems
- Halogen lamps
- Incandescent bulbs
- Light-emitting diodes (LEDs)
- HID Xenon ballasts
- DC motors

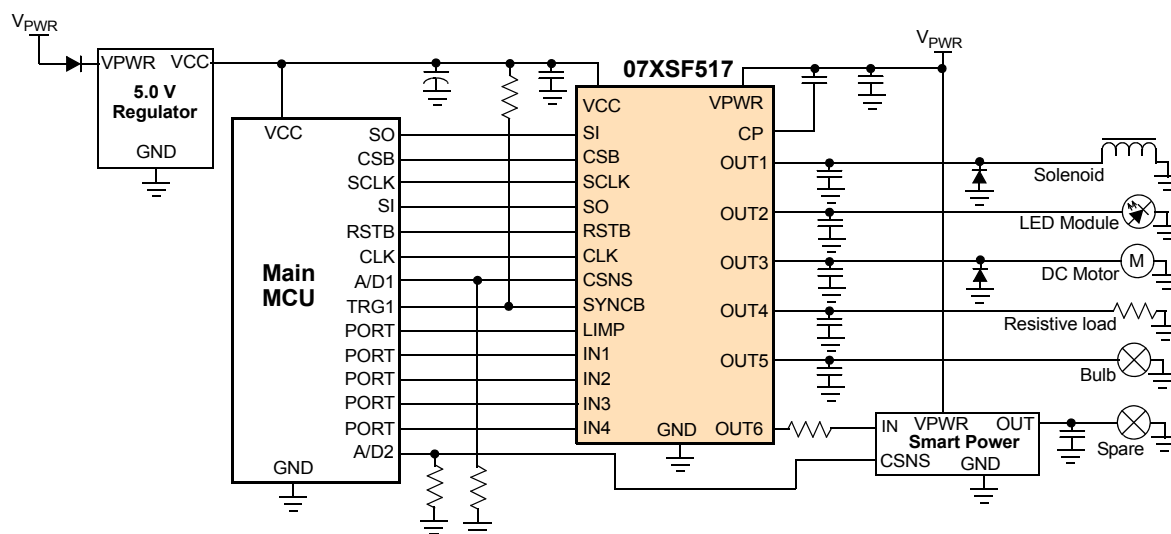

**Figure 1. Triple 7.0 mOhm and Dual 17 mOhm Simplified Application Diagram**

\* This document contains certain information on a new product. Specifications and information herein are subject to change without notice.

# 1 Orderable Parts

This section describes the part numbers available to be purchased along with their differences.

**Table 1. Orderable Part Variations**

Part Number	Notes	Temperature (T <sub>A</sub> )	Package	OUT1 Rds(on)	OUT2 Rds(on)	OUT3 Rds(on)	OUT4 Rds(on)	OUT5 Rds(on)	OUT6
MC07XSF517EK	(1)	-40 to 125 °C	SOIC 54 pins exposed pad	17 mΩ	17 mΩ	7.0 mΩ	7.0 mΩ	7.0 mΩ	Yes

Notes

1. To Order parts in Tape & Reel, add the R2 suffix to the part number.

Valid orderable part numbers are provided on the web. To determine the orderable part numbers for this device, go to <http://www.freescale.com> and perform a part number search for the following device numbers: 07XSF517.

# Table of Contents

2	Internal Block Diagram	5
3	Pin Connections	6
3.1	Pinout Diagram	6
3.2	Pin Definitions	6
4	General Product Characteristics	9
4.1	Relationship Between Ratings and Operating Requirements	9
4.2	Maximum Ratings	10
4.4	Operating Conditions	11
4.5	Supply Currents	12
5	General IC Functional Description and Application Information	13
5.1	Introduction	13
5.2	Features	13
5.3	Block Diagram	14
5.3.1	Self-protected High Side Switches	14
5.3.2	Power Supply	14
5.3.3	MCU Interface and Device Control	14
5.4	Functional Description	14
5.5	Modes of Operation	15
5.5.1	Power Off Mode	15
5.5.2	Sleep Mode	15
5.5.3	Normal Mode	15
5.5.4	Fail Mode	16
5.5.5	Mode Transitions	16
5.6	SPI Interface and Configurations	17
5.6.1	Introduction	17
5.6.2	SPI Input Register and Bit Descriptions	17
5.6.3	SPI Output Register and Bit Descriptions	19
5.6.4	Timing Diagrams	20
5.6.5	Electrical Characterization	21
6	Functional Block Requirements and Behaviors	22
6.1	Self-protected High Side Switches Description and Application Information	22
6.1.1	Features	22
6.1.2	Output Pulse Shaping	22
6.1.3	Output Protections	27
6.1.4	Output Clamps	40
6.1.5	Digital Diagnostics	41
6.1.6	Analog Diagnostics	47
6.2	Power Supply Functional Block Description and Application Information	55
6.2.1	Introduction	55
6.2.2	Wake State Reporting	55
6.2.3	Supply Voltages Disconnection	56
6.3	Communication Interface and Device Control Functional Block Description and Application Information	57
6.3.1	Introduction	57
6.3.2	Fail Mode Input (LIMP)	57
6.3.3	MCU Communication Interface Protections	58
6.3.4	External Smart Power Control (OUT6)	60

7	Typical Applications	61
7.1	Introduction	61
7.1.1	Application Diagram	61
7.1.2	Application Instructions	62
7.1.3	Bill of Material	62
7.2	EMC and EMI Considerations	63
7.2.1	EMC/EMI Tests	63
7.2.1	EMC/EMI Tests	63
7.2.2	Fast Transient Pulse Tests	63
7.3	Robustness Considerations	64
7.4	PCB Layout Recommendations	65
7.5	Thermal Information	66
7.5.1	Thermal Transient	66
7.5.2	R/C Thermal Model	66
8	Packaging	67
8.1	Marking Information	67
8.2	Package Mechanical Dimensions	67
9	Revision History	71

## 2 Internal Block Diagram

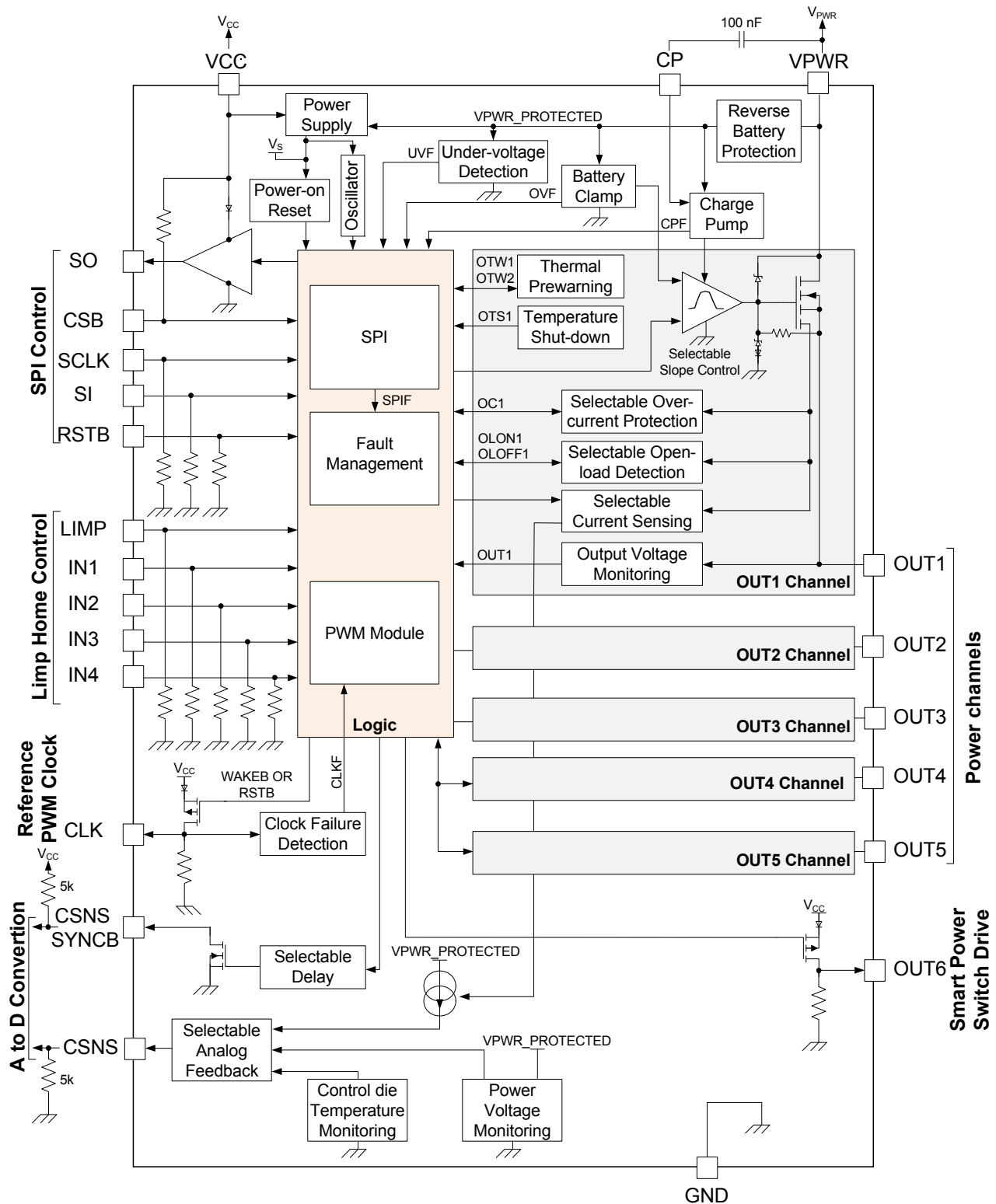

Figure 2. Simplified Internal Block Diagram (Penta version)

## 3 Pin Connections

### 3.1 Pinout Diagram

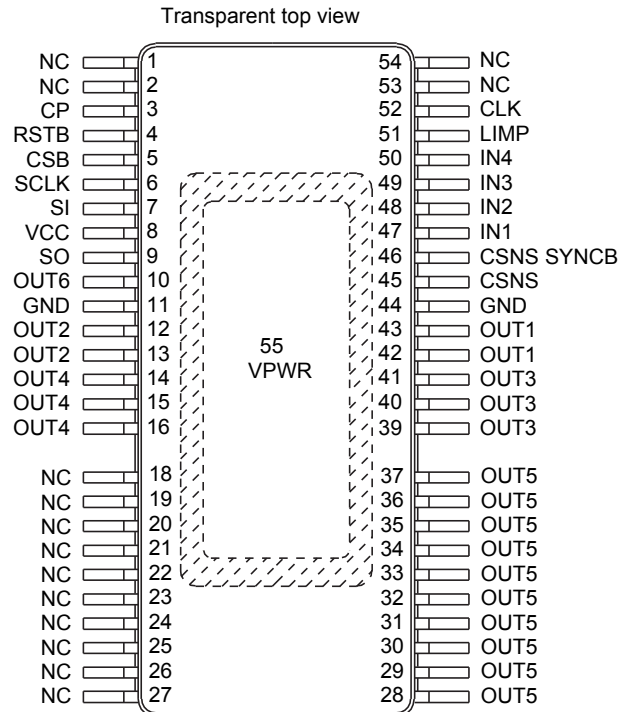

Figure 3. Pinout Diagram

### 3.2 Pin Definitions

Table 2. 07XSF517 Pin Definitions

Pin Number	Pin Name	Pin Function	Formal Name	Definition
3	CP	Internal supply	Charge-pump	This pin is the connection for an external capacitor for charge pump use only.
4	RSTB	SPI	Reset	This input pin is used to initialize the device configuration and fault registers, as well as place the device in a low-current sleep mode. This pin has a passive internal pull-down.
5	CSB	SPI	Chip select	This input pin is connected to a chip select output of a master microcontroller (MCU). When this digital signal is high, SPI signals are ignored. Asserting this pin low starts an SPI transaction. The transaction is indicated as completed when this signal returns to high level. This pin has a passive internal pull-up to $V_{CC}$ through a diode.
6	SCLK	SPI	Serial clock	This input pin is connected to the MCU providing the required bit shift clock for SPI communication. This pin has a passive internal pull-down.
7	SI	SPI	Serial input	This pin is the data input of the SPI communication interface. The data at the input are sampled on the positive edge of the SCLK. This pin has a passive internal pull-down.

**Table 2. 07XSF517 Pin Definitions (continued)**

Pin Number	Pin Name	Pin Function	Formal Name	Definition
8	VCC	Power supply	MCU power supply	This pin is a power supply pin for internal logic, the SPI I/Os and the OUT6 driver.
9	SO	SPI	Serial Output	This output pin is connected to the SPI Serial Data Input pin of the MCU or to the SI pin of the next device of a daisychain of devices. The SPI changes on the negative edge of SCLK. When CSB is high, this pin is high-impedance.
10	OUT6	Output	External Solid State	This output pin controls an external Smart Power Switch by logic level. This pin has a passive internal pull-down.
11, 44	GND	Ground	Ground	These pins are the ground for the logic and analog circuitries of the device. For ESD and electrical parameter accuracy purpose, the ground pins must be shorted on the board.
12, 13	OUT2	Output	Channel #2	Protected high side power output pins to the load.
14, 15, 16	OUT4	Output	Channel #4	Protected high side power output pins to the load.
1, 2, 18... 27, 53, 54	NC	N/A	Not connected	These pins are not connected.
28... 37	OUT5	Output	Channel #5	Protected high side power output pins to the load.
39, 40, 41	OUT3	Output	Channel #3	Protected high side power output pins to the load.
42, 43	OUT1	Output	Channel #1	Protected high side power output pins to the load.
45	CSNS	Feedback	Current sense	This pin reports an analog value proportional to the designated OUT[1:5] output current or the temperature of the exposed pad or the supply voltage. It is used externally to generate a ground-referenced voltage for the microcontroller (MCU). Current recopy and analog voltage feedbacks are SPI programmable.
46	CSNS SYNCB	Feedback	Current sense synchronization	This open drain output pin allows synchronizing the MCU A/D conversion. This pin requires an external pull-up resistor to VCC.
47	IN1	Input	Direct input #1	This input wakes up the device. This input pin is used to directly control corresponding channel in Fail mode. During Normal mode the control of the outputs by the control inputs is SPI programmable. This pin has a passive internal pull-down.
48	IN2	Input	Direct input #2	This input wakes up the device. This input pin is used to directly control corresponding channel in Fail mode. During Normal mode the control of the outputs by the control inputs is SPI programmable. This pin has a passive internal pull-down.
49	IN3	Input	Direct input #3	This input wakes up the device. This input pin is used to directly control corresponding channel in Fail mode. During Normal mode the control of the outputs by the control inputs is SPI programmable. This pin has a passive internal pull-down.
50	IN4	Input	Direct input #4	This input wakes up the device. This input pin is used to directly control corresponding channel in Fail mode. During Normal mode the control of the outputs by the control inputs is SPI programmable. This pin has a passive internal pull-down.
51	LIMP	Input	Limp Home	The Fail mode can be activated by this digital input. This pin has a passive internal pull-down.

**Table 2. 07XSF517 Pin Definitions (continued)**

Pin Number	Pin Name	Pin Function	Formal Name	Definition
52	CLK	Input/Output	Device mode feedback Reference PWM clock	This pin is an input/output pin. It is used to report the device sleep-state information. It is also used to apply reference PWM clock which will be divided by $2^8$ in Normal operating mode. This pin has a passive internal pull-down.
55	VPWR	Power Supply	Supply power supply	This exposed pad connects to the positive power supply and is the source of operational power for the device.

Pins 17 and 38 are omitted.



# 4 General Product Characteristics

## 4.1 Relationship Between Ratings and Operating Requirements

The analog portion of device is supplied by the voltage applied to the VPWR exposed pad. Thereby the supply of internal circuitry (logic in case of a V<sub>CC</sub> disconnect, charge pump, gate drive,...) is derived from the VPWR pin.

In case of a reverse supply:

- the internal supply rail is protected (max. -16 V)
- the output drivers (OUT1... OUT5) are switched on, to reduce the power consumption in the drivers when using incandescent bulbs

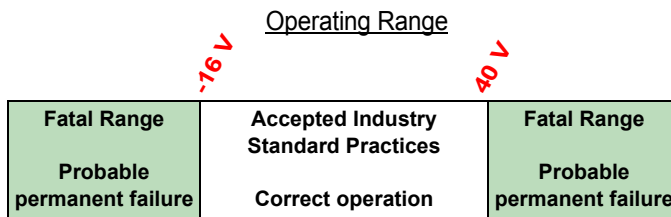
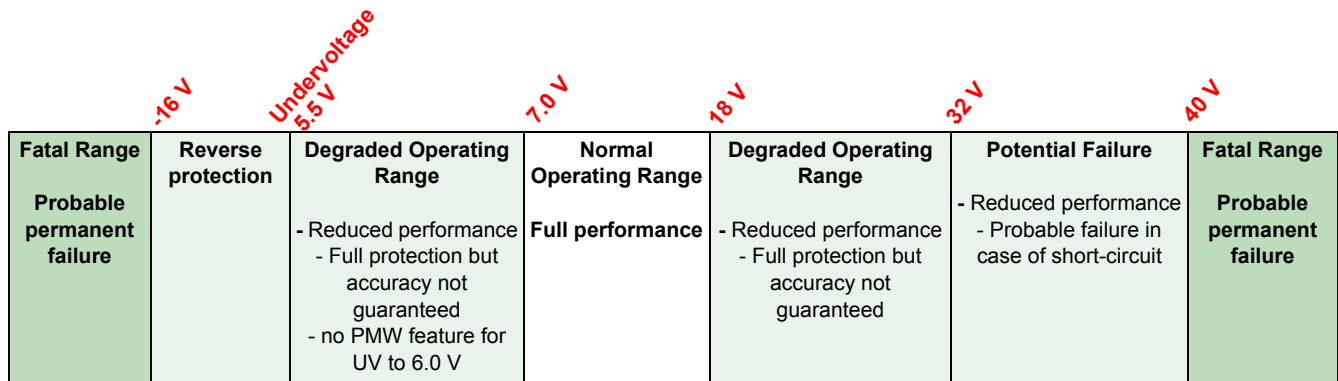

Handling Conditions (Power OFF)

Figure 4. Ratings vs. Operating Requirements (VPWR pin)

The device's digital circuitry is powered by the voltage applied to the VCC pin. If VCC is disconnected, the logic part is supplied by the VPWR pin.

The output driver for SPI signals, CLK pin (wake feedback), and OUT6 are supplied by the VCC pin only. This pin shall be protected externally in case of a reverse polarity, and in case of a high-voltage disturbance.

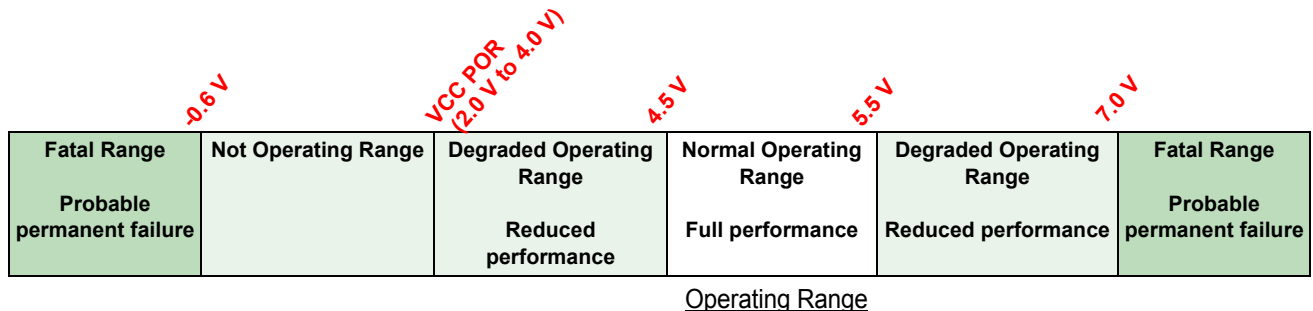

Operating Range

Figure 5. Ratings vs. Operating Requirements (VCC pin)

## 4.2 Maximum Ratings

**Table 3. Maximum Ratings**

All voltages are with respect to ground unless otherwise noted. Exceeding these ratings may cause a malfunction or permanent damage to the device.

Symbol	Description (Rating)	Min.	Max.	Unit	Notes
<b>ELECTRICAL RATINGS</b>					
$V_{PWR}$	$V_{PWR}$ Voltage Range	-16	40	V	
$V_{CC}$	VCC Logic Supply Voltage	-0.3	7.0	V	
$V_{IN}$	Digital Input Voltage <ul style="list-style-type: none"> <li>• IN1... IN4 and LIMP</li> <li>• CLK, SI, SCLK, CSB, and RSTB</li> </ul>	-0.3 -0.3	40 20	V	(2)
$V_{OUT}$	Digital Output Voltage <ul style="list-style-type: none"> <li>• SO, CSNS, SYNC, OUT6, CLK</li> </ul>	-0.3	20	V	(2)
$I_{CL}$	Negative Digital Input Clamp Current	–	5.0	mA	(3)
$I_{OUT}$	Power Channel Current <ul style="list-style-type: none"> <li>• 7.0 m<math>\Omega</math> channel</li> <li>• 17 m<math>\Omega</math> channel</li> </ul>	– –	11 5.5	A	(4)
$E_{CL}$	Power Channel Clamp Energy Capability <ul style="list-style-type: none"> <li>• 7.0 m<math>\Omega</math> channel - Initial <math>T_J = 25\text{ }^\circ\text{C}</math></li> <li>• 7.0 m<math>\Omega</math> channel - Initial <math>T_J = 150\text{ }^\circ\text{C}</math></li> <li>• 17 m<math>\Omega</math> channel - Initial <math>T_J = 25\text{ }^\circ\text{C}</math></li> <li>• 17 m<math>\Omega</math> channel - Initial <math>T_J = 150\text{ }^\circ\text{C}</math></li> </ul>	– – – –	200 100 100 50	mJ	(5)
$V_{ESD}$	ESD Voltage <ul style="list-style-type: none"> <li>• Human Body Model (HBM) - <math>V_{PWR}</math>, Power Channel, and GND pins</li> <li>• Human Body Model (HBM) - All other pins</li> <li>• Charge Device Model (CDM) - Corner pins</li> <li>• Charge Device Model (CDM) - All other pins</li> </ul>	-8000 -2000 -750 -500	+8000 +2000 +750 +500	V	(6)

**Notes**

2. Exceeding voltage limits on those pins may cause a malfunction or permanent damage to the device.
3. Maximum current in negative clamping for IN1... IN4, LIMP, RSTB, CLK, SI, SO, SCLK, and CSB pins
4. Continuous high side output current rating so long as maximum junction temperature is not exceeded. Calculation of maximum output current using package thermal resistance is required.
5. Active clamp energy using single-pulse method ( $L = 2.0\text{ mH}$ ,  $R_L = 0\text{ }\Omega$ ,  $V_{PWR} = 14\text{ V}$ ). Please refer to [Output Clamps](#) section.
6. ESD testing is performed in accordance with the Human Body Model (HBM) ( $C_{ZAP} = 100\text{ pF}$ ,  $R_{ZAP} = 1500\text{ }\Omega$ ), and the Charge Device Model.

## 4.3 Thermal Characteristics

**Table 4. Thermal Ratings**

All voltages are with respect to ground unless otherwise noted. Exceeding these ratings may cause a malfunction or permanent damage to the device.

Symbol	Description (Rating)	Min.	Max.	Unit	Notes
<b>THERMAL RATINGS</b>					
$T_A$	Operating Temperature	-40	+125	°C	(7)
$T_J$	• Ambient • Junction	-40	+150		
$T_{STG}$	Storage Temperature	-55	+ 150	°C	
$T_{PPRT}$	Peak Package Reflow Temperature During Reflow	–	260	°C	(8) (9)

**THERMAL RESISTANCE AND PACKAGE DISSIPATION RATINGS**

$R_{\theta JB}$	Junction-to-Board (1]Soldered to Board)	–	2.5	°/W	(10)
$R_{\theta JA}$	Junction-to-Ambient, Natural Convection, Four-Layer Board (2s2p)	–	17.4	°/W	(11) (12)
$R_{\theta JC}$	Junction-to-Case (Case top surface)	–	10.6	°/W	(13)

**Notes**

- To achieve high reliability over 10 years of continuous operation, the device's continuous operating junction temperature should not exceed 125 °C.
- Pin soldering temperature limit is for 10 seconds maximum duration. Not designed for immersion soldering. Exceeding these limits may cause malfunction or permanent damage to the device.
- Freescall's Package Reflow capability meets Pb-free requirements for JEDEC standard J-STD-020C. For Peak Package Reflow Temperature and Moisture Sensitivity Levels (MSL), Go to [www.freescale.com](http://www.freescale.com), search by part number [e.g. remove prefixes/suffixes and enter the core ID to view all orderable parts. (i.e. MC33xxx enter 33xxx), and review parametrics.
- Thermal resistance between the die and the printed circuit board per JEDEC JESD51-8. Board temperature is measured on the top surface of the board near the package.
- Junction temperature is a function of die size, on-chip power dissipation, package thermal resistance, mounting site (board) temperature, ambient temperature, air flow, power dissipation of other components on the board, and board thermal resistance.
- Per JEDEC JESD51-6 with the board (JESD51-7) horizontal.
- Thermal resistance between the die and the case top surface as measured by the cold plate method (MIL SPEC-883 Method 1012.1).

## 4.4 Operating Conditions

This section describes the operating conditions of the device. Conditions apply to all the following data, unless otherwise noted.

**Table 5. Operating Conditions**

All voltages are with respect to ground unless otherwise noted. Exceeding these ratings may cause a malfunction or permanent damage to the device.

Symbol	Ratings	Min	Max	Unit	Notes
$V_{PWR}$	Functional operating supply voltage - Device is fully functional. All features are operating.	7.0	18	V	
	Overvoltage range	–	28	V	
	• Jump Start • Load dump	–	40		
	Reverse Supply	-16	–	V	
$V_{CC}$	Functional operating supply voltage - Device is fully functional. All features are operating.	4.5	5.5	V	

## 4.5 Supply Currents

This section describes the current consumption characteristics of the device.

**Table 6. Supply Currents**

Characteristics noted under conditions  $4.5\text{ V} \leq V_{CC} \leq 5.5\text{ V}$ ,  $-40\text{ }^\circ\text{C} \leq T_A \leq 125\text{ }^\circ\text{C}$ ,  $GND = 0\text{ V}$ , unless otherwise noted. Typical values noted reflect the approximate parameter means at  $T_A = 25\text{ }^\circ\text{C}$  under nominal conditions, unless otherwise noted.

Symbol	Ratings	Min	Typ.	Max	Unit	Notes
<b>VPWR CURRENT CONSUMPTIONS</b>						
$I_{QVPWR}$	Sleep mode measured at $V_{PWR} = 12\text{ V}$ <ul style="list-style-type: none"> <li>• <math>T_A = 25\text{ }^\circ\text{C}</math></li> <li>• <math>T_A = 125\text{ }^\circ\text{C}</math></li> </ul>	–	1.2	5.0	$\mu\text{A}$	(14) (15)
$I_{VPWR}$	Operating mode measured at $V_{PWR} = 18\text{ V}$	–	7.0	8.0	mA	(15)
<b>VCC CURRENT CONSUMPTIONS</b>						
$I_{QVCC}$	Sleep mode measured at $V_{CC} = 5.5\text{ V}$	–	0.05	5.0	$\mu\text{A}$	
$I_{VCC}$	Operating mode measured at $V_{PWR} = 5.5\text{ V}$ (SPI frequency 5.0 MHz)	–	2.8	4.0	mA	

Notes

14. With the OUT1... OUT5 power channels grounded.
15. With the OUT1... OUT5 power channels opened.

# 5 General IC Functional Description and Application Information

## 5.1 Introduction

The 07XSF517 is an evolution of the successful Gen3 by providing improved features of a complete family of devices using Freescale's latest and unique technologies for the controller and the power stages.

It consists of a scalable family of devices compatible in terms of software driver and package footprint. It allows diagnosing the light-emitting diodes (LEDs) with an enhanced current sense precision with synchronization pin, as well as driving high power motors with a perfect control of its current consumption. It combines flexibility through daisy chainable SPI 5.0 MHz, extended digital and analog feedbacks, safety, and robustness. It integrates an enhanced PWM module with 8-bit duty cycle capability and PWM frequency prescaler per power channel.

## 5.2 Features

The main attributes of 07XSF517 are:

- Penta high side switches with overload, overtemperature and undervoltage protection
- control output for 1 external smart power switch
- 16 Bit SPI communication interface with daisy chain capability
- integrated Fail mode (ASIL B compliant functional safety behavior)
- dedicated control inputs for use in Fail mode
- analog feedback pin with SPI programmable multiplexer and sync signal
- channel diagnosis by SPI communication
- advanced current sense mode for LED usage
- synchronous PWM module with external clock, prescaler and multiphase feature
- excellent EMC behavior
- power net and reverse polarity protection
- ultra low power mode
- scalable and flexible family concept
- board layout compatible SOIC54 package with exposed pad

## 5.3 Block Diagram

The choice of multi-die technology in SOIC exposed pad package including low cost vertical trench FET power die associated with Smart Power control die lead to an optimized solution.

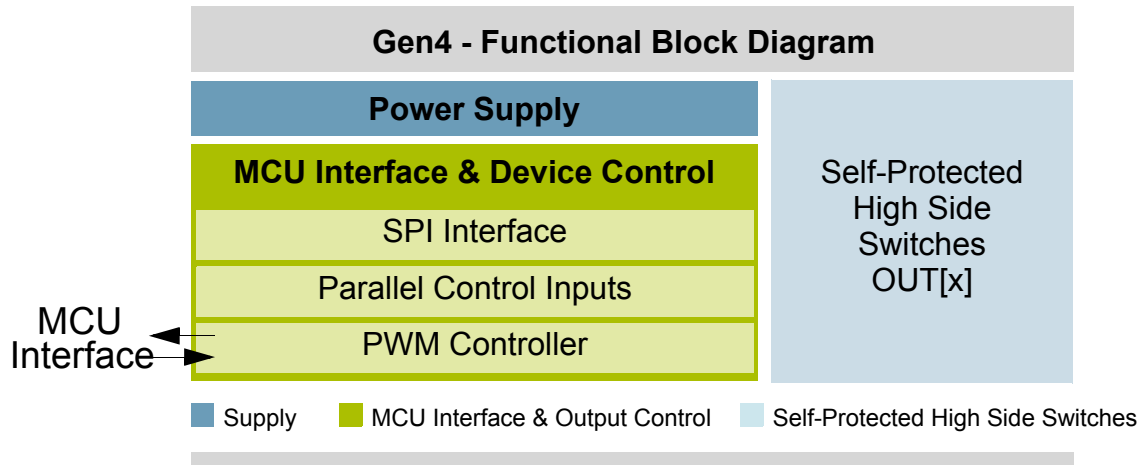

Figure 6. Functional Block Diagram

### 5.3.1 Self-protected High Side Switches

OUT1... OUT5 are the output pins of the power switches. The power channels are protected against various kinds of short-circuits and have active clamp circuitry that may be activated when switching off inductive loads. Many protective and diagnostic functions are available.

### 5.3.2 Power Supply

The device operates with supply voltages from 5.5 to 40 V ( $V_{PWR}$ ), but is full spec. compliant only between 7.0 and 18 V. The VPWR pin supplies power to the internal regulator, analog, and logic circuit blocks. The VCC pin (5.0 V typ.) supplies the output register of the serial peripheral interface (SPI). Consequently, the SPI registers cannot be read without presence of  $V_{CC}$ . The employed IC architecture guarantees a low quiescent current in Sleep mode.

### 5.3.3 MCU Interface and Device Control

In Normal mode the power output channels are controlled by the embedded PWM module, which is configured by the SPI register settings. For bidirectional SPI communication,  $V_{CC}$  has to be in the authorized range. Failure diagnostics and configuration are also performed through the SPI port. The reported failure types are: open-load, short-circuit to supply, severe short-circuit to ground, overcurrent, overtemperature, clock-fail, and under and overvoltage.

The device allows driving loads at different frequencies up to 400 Hz.

## 5.4 Functional Description

The device has four fundamental operating modes: Sleep, Normal, Fail, and Power off. It possesses multiple high side switches (power channels) each of which can be controlled independently:

- in Normal mode by SPI interface. For bidirectional SPI communication, a second supply voltage ( $V_{CC}$ ) is required.
- in Fail mode by the corresponding the direct inputs IN1... IN4. The OUT5 for the Penta version and the OUT6 are off in this mode.

## 5.5 Modes of Operation

The operating modes are based on the signals:

- wake = (IN1\_ON) OR (IN2\_ON) OR (IN3\_ON) OR (IN4\_ON) OR (RST\). More details in [Logic I/O Plausibility Check](#) section.
- fail = (SPI\_fail) OR (LIMP). More details in [Loss of Communication Interface](#) section.

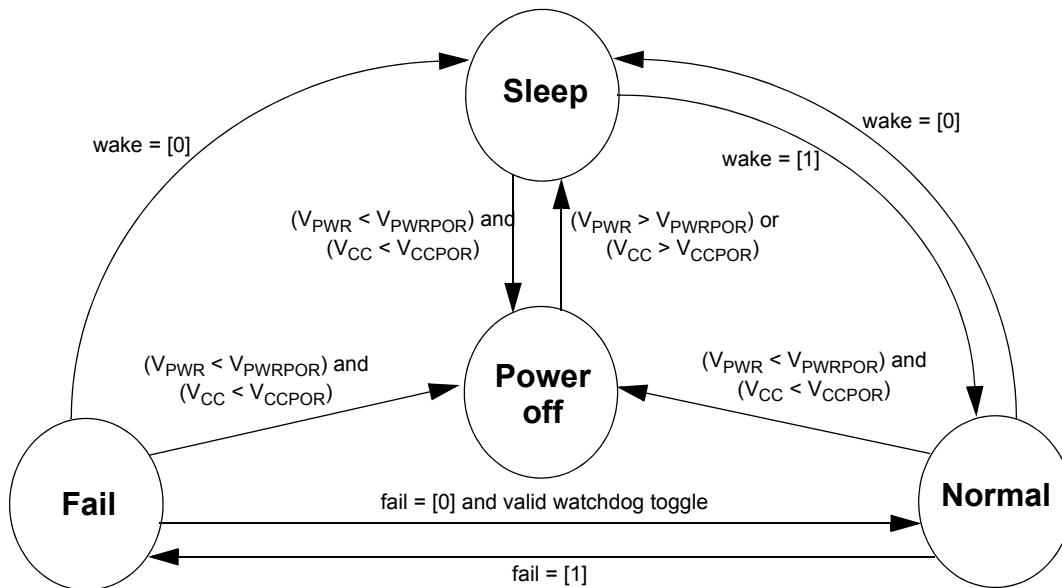

Figure 7. General IC Operating Modes

### 5.5.1 Power Off Mode

The power off mode is applied when  $V_{PWR}$  and  $V_{CC}$  are below the power on reset threshold ( $V_{PWR\ POR}$ ,  $V_{CC\ POR}$ ). In power off, no functionality is available but the device is protected by the clamping circuits. Refer to [Supply Voltages Disconnection](#) section.

### 5.5.2 Sleep Mode

The Sleep mode is used to provide ultra low current consumption. During Sleep mode:

- the component is inactive and all outputs are disabled
- the outputs are protected by the clamping circuits
- the pull-up / pull-down resistors are present

The Sleep mode is the default mode of the device after applying the supply voltages ( $V_{PWR}$  or  $V_{CC}$ ) prior to any wake-up condition (wake = [0]).

The wake-up from Sleep mode is provided by the wake signal.

### 5.5.3 Normal Mode

The Normal mode is the regular operating mode of the device. The device is in Normal mode, when the device is in the wake state (wake = [1]) and no fail condition (fail = [0]) is detected.

During Normal mode:

- the power outputs are under control of the SPI
- the power outputs are controlled by the programmable PWM module

- the power outputs are protected by the overload protection circuit
- the control of the power outputs by SPI programming
- the digital diagnostic feature transfers status of the smart switch via the SPI
- the analog feedback output (CSNS and CSNS SYNC) can be controlled by SPI

The channel control (CHx) can be summarized:

- CH1... 4 controlled by ONx or iINx (if it is programmed by SPI)
- CH5... 6 controlled by ONx
- Rising CHx by definition means starting over current window for OUT1... 5.

## 5.5.4 Fail Mode

The device enters the Fail mode, when

- the LIMP input pin is high (logic [1])
- or a SPI failure is detected

During Fail mode (wake = [1] & fail = [1]):

- the OUT1... OUT4 outputs are directly controlled by the corresponding control inputs (IN1... IN4)
- the OUT5... OUT6 are turned off
- the PWM module is not available
- while no SPI control is feasible, the SPI diagnosis is functional (depending on the fail mode condition):
  - the SO shall report the content of SO register defined by SOA0 to 3 bits
- the outputs are fully protected in case of an overload, overtemperature, and undervoltage
- no analog feedback is available
- the max. output overcurrent profile is activated (OCLO and window times)
- in case of an overload condition or undervoltage, the autorestart feature controls the OUT1... OUT4 outputs
- in case of an overtemperature condition, OCHI1 detection, or severe short-circuit detection, the corresponding output is latched OFF until a new wake-up event.

The channel control (CHx) can be summarized:

- CH1... 4 controlled by iINx, while the overcurrent windows are controlled by IN\_ONx
- CH5... 6 are off

## 5.5.5 Mode Transitions

After a wake-up:

- a power on reset is applied and all SPI SI and SO registers are cleared (logic[0])
- the faults are blanked during  $t_{BLANKING}$

The device enters in Normal mode after start-up if following sequence is provided:

- $V_{PWR}$  and  $V_{CC}$  power supplies must be above their undervoltage thresholds (Sleep mode)
- generate wake-up event (wake =1) setting RSTB from 0 to 1

The device initialization will be completed after 50  $\mu$ sec (typ). During this time, the device is robust in case of  $V_{PWR}$  interrupts higher than 150nsec.

The transition from “Normal mode” to “Fail mode” is executed immediately when a fail condition is detected.

During the transition, the SPI SI settings are cleared and the SPI SO registers are not cleared.

When the Fail mode condition was a:

- LIMP input, WD toggle timeout, WD toggle sequence, or a SPI modulo 16 error, the SPI diagnosis is available during Fail mode
- SI / SO stuck to static level, the SPI diagnosis is not available during Fail mode

The transition from “Fail mode” to “Normal mode” is enabled, when

- the fail condition is removed and
- two SPI commands are sent within a valid watchdog cycle (first WD=[0] and then WD=[1])



During this transition:

- all SPI SI and SO registers are cleared (logic[0])
- the DSF (device status flag) in the registers #1... #7 and the RCF (Register Clearer flag) in the device status register #1 are set (logic[1])

To delatch the RCF diagnosis, a read command of the quick status register #1 must be performed.

## 5.6 SPI Interface and Configurations

### 5.6.1 Introduction

The SPI is used to

- control the device in case of Normal mode
- provide diagnostics in case of Normal and Fail mode

The SPI is a 16 Bit full-duplex synchronous data transfer interface with daisy chain capability.

The interface consists of four I/O lines with 5.0 V CMOS logic levels and termination resistors:

- The SCLK pin clocks the internal shift registers of the device
- The SI pin accepts data into the input shift register on the rising edge of the SCLK signal
- The SO pin changes its state on the rising edge of SCLK and reads out on the falling edge
- The CSB enables the SPI interface
  - with the leading edge of CS\ the registers are loaded
  - while CSB is logic [0] SI/SO data are shifted
  - with the trailing edge of the CSB signal, SPI data is latched into the internal registers
  - when CSB is logic [1], the signals at the SCLK and SI pins are ignored and SO is high-impedance

When the RSTB input is

- low (logic [0]), the SPI and the fault registers are reset. The Wake state then depends on the status of the input pins (IN\_ON1... IN\_ON4)
- high (logic[1]), the device is in Wake status and the SPI is enabled

The functionality of the SPI is checked by a plausibility check. In case of a SPI failure the device enters the Fail mode.

### 5.6.2 SPI Input Register and Bit Descriptions

The first nibble of the 16 bit data word (D15... D12) serves as address bits.

Register	SI address				SI data												
	#	D15	D14	D13	D12	D11	D10	D9	D8	D7	D6	D5	D4	D3	D2	D1	D0
name		4 Bit address				WD	11 Bit data										

11 bits (D10... D1) are used as data bits.

The D11 bit is the WD toggle bit. This bit has to be toggled with each write command.

When the toggling of the bit is not executed within the WD timeout, a SPI fail is detected.

All register values are logic [0] after a reset. The predefined value is off / inactive unless otherwise noted.

Register	#	SI address				SI data											
		D15	D14	D13	D12	D11	D10	D9	D8	D7	D6	D5	D4	D3	D2	D1	D0
Initialisation 1	0	0	0	0	0	WD	WD SEL	SYNC EN1	SYNC EN0	MUX2	MUX1	MUX0	SOA MODE	SOA3	SOA2	SOA1	SOA0
Initialisation 2	1	0	0	0	1	WD	OCHI THERMAL	OCHI TRANSPARENT	NO HID1	NO HID0	OCHI OD5	OCHI OD4	OCHI OD3	OCHI OD2	OCHI OD1	PWM sync	OTW SEL
CH1 control	2	0	0	1	0	WD	PH11	PH01	ON1	PWM71	PWM61	PWM51	PWM41	PWM31	PWM21	PWM11	PWM01
CH2 control	3	0	0	1	1	WD	PH12	PH02	ON2	PWM72	PWM62	PWM52	PWM42	PWM32	PWM22	PWM12	PWM02
CH3 control	4	0	1	0	0	WD	PH13	PH03	ON3	PWM73	PWM63	PWM53	PWM43	PWM33	PWM23	PWM13	PWM03
CH4 control	5	0	1	0	1	WD	PH14	PH04	ON4	PWM74	PWM64	PWM54	PWM44	PWM34	PWM24	PWM14	PWM04
CH5 control	6	0	1	1	0	WD	PH15	PH05	ON5	PWM75	PWM65	PWM55	PWM45	PWM35	PWM25	PWM15	PWM05
CH6 control	7	0	1	1	1	WD	PH16	PH06	ON6	PWM76	PWM66	PWM56	PWM46	PWM36	PWM26	PWM16	PWM06
output control	8	1	0	0	0	WD	PSF5	PSF4	PSF3	PSF2	PSF1	ON6	ON5	ON4	ON3	ON2	ON1
Global PWM control	9-1	1	0	0	1	WD	0	X	X	X	X	GPWM EN6	GPWM EN5	GPWM EN4	GPWM EN3	GPWM EN2	GPWM EN1
	9-2	1	0	0	1	WD	1	X	X	GPWM7	GPWM6	GPWM5	GPWM4	GPWM3	GPWM2	GPWM1	GPWM0
over current control	10-1	1	0	1	0	WD	0	OCL05	OCL04	OCL03	OCL02	OCL01	ACM EN5	ACM EN4	ACM EN3	ACM EN2	ACM EN1
	10-2	1	0	1	0	WD	1	NO OCH15	NO OCH14	NO OCH13	NO OCH12	NO OCH11	SHORT OCH15	SHORT OCH14	SHORT OCH13	SHORT OCH12	SHORT OCH11
input enable	11	1	0	1	1	WD	0	X	X	INEN14	INEN04	INEN13	INEN03	INEN12	INEN02	INEN11	INEN01
prescaler settings	12-1	1	1	0	0	WD	0	PRS15	PRS05	PRS14	PRS04	PRS13	PRS03	PRS12	PRS02	PRS11	PRS01
	12-2	1	1	0	0	WD	1	X	X	X	X	X	X	X	X	PRS16	PRS06
OL control	13-1	1	1	0	1	WD	0	OLON DGL5	OLON DGL4	OLON DGL3	OLON DGL2	OLON DGL1	OLOFF EN5	OLOFF EN4	OLOFF EN3	OLOFF EN2	OLOFF EN1
OLLED control	13-2	1	1	0	1	WD	1	res	res	res	res	OLLED TRIG	OLLED EN5	OLLED EN4	OLLED EN3	OLLED EN2	OLLED EN1
increment / decrement	14	1	1	1	0	WD	INCR SGN	INCR15	INCR05	INCR14	INCR04	INCR13	INCR03	INCR12	INCR02	INCR11	INCR01
testmode	15	1	1	1	1	X	X	X	X	X	X	X	X	X	X	X	X

<p>WD #0-#14 = watchdog toggle bit</p> <p>SOA0 ~ SOA3 #0 = address of next SO data word</p> <p>SOA MODE #0 = single read address of next SO data word</p> <p>MUX0 ~ MUX2 #0 = CSN multiplexer setting</p> <p>SYNC EN0 ~ SYNC EN1 #0 = SYNC delay setting</p> <p>WD SEL #0 = watchdog timeout select</p> <p>OTW SEL #1 = over temperature warning threshold selection</p> <p>PWM SYNC #1 = reset clock module</p> <p>OCH ODx #1 = OCH1 window load demand</p> <p>NO HIDx #1 = HID outputs selection</p> <p>OCH THERMAL #1 = OCH11 level depending on control die temperature</p> <p>OCH TRANSPARENT #1 = OCH11 level adjusted during OFF to ON transition</p> <p>PWM0x ~ PWM7x #2-#7 = PWM value (8Bit)</p> <p>PH0x ~ PH1x #2-#7 = phase control</p> <p>ONx #2-#8 = channel on/off incl. OCH1 control</p> <p>PSFx #8 = pulse skipping feature for power output channels</p> <p>GPWM ENx #9-1 = global PWM enable</p> <p>GPWM1 ~ GPWM7 #9-2 = global PWM value (8Bit)</p> <p>ACM ENx #10-1 = advanced current sense mode enable</p> <p>OCL0x #10-1 = OCL0 level control</p> <p>SHORT OCHx #10-2 = use short OCH1 window time</p> <p>NO OCHx #10-2 = start with OCL0 threshold</p> <p>INENx ~ INEN1x #11 = input enable control</p> <p>PRS0x ~ PRS1x #12 = prescaler setting</p> <p>OLOFF ENx #13-1 = OL load in off state enable</p> <p>OLON DGLx #13-1 = OL ON deglitch time</p> <p>OLLED ENx #13-2 = OL LED mode enable</p> <p>OLLED TRIG #13-2 = trigger for OLLED detection in 100% d.c.</p> <p>INCR SGN #14 = PWM increment / decrement sign</p> <p>INCR0x ~ INCR1x #14 = PWM increment / decrement setting</p>	<p>#0</p> <p><b>SYNC EN1</b>   <b>SYNC EN0</b>   <b>Sync status</b></p> <p>0   0   sync off</p> <p>0   1   valid</p> <p>1   0   trig0</p> <p>1   1   trig1/2</p> <p>#1</p> <p><b>NO HID1 NO HID0 Selection</b></p> <p>0   0   available for all channels</p> <p>0   1   available for channel 3 only</p> <p>1   0   available for channels 3 and 4 only</p> <p>1   1   unavailable for all channels</p> <p>#2-#7</p> <p><b>PH 1x</b>   <b>PH 0x</b>   <b>Phase</b></p> <p>0   0   0°</p> <p>0   1   90°</p> <p>1   0   180°</p> <p>1   1   270°</p> <p>#11</p> <table border="1"> <thead> <tr> <th>ONx</th> <th>INEN1x</th> <th>INEN0x</th> <th>GPWM ENx</th> <th>INx=0</th> <th>INx=1</th> </tr> <tr> <th></th> <th></th> <th></th> <th></th> <th>OUTx</th> <th>PWMx</th> </tr> </thead> <tbody> <tr> <td>0</td> <td>x</td> <td>x</td> <td>x</td> <td>OFF</td> <td>x</td> </tr> <tr> <td>0</td> <td>0</td> <td>0</td> <td>0</td> <td>ON</td> <td>individual</td> </tr> <tr> <td>0</td> <td>0</td> <td>1</td> <td>1</td> <td>ON</td> <td>global</td> </tr> <tr> <td>0</td> <td>0</td> <td>1</td> <td>0</td> <td>OFF</td> <td>individual</td> </tr> <tr> <td>0</td> <td>1</td> <td>1</td> <td>1</td> <td>OFF</td> <td>global</td> </tr> <tr> <td>1</td> <td>1</td> <td>0</td> <td>0</td> <td>OFF</td> <td>individual</td> </tr> <tr> <td>1</td> <td>1</td> <td>0</td> <td>1</td> <td>OFF</td> <td>global</td> </tr> <tr> <td>1</td> <td>1</td> <td>1</td> <td>1</td> <td>ON</td> <td>global</td> </tr> </tbody> </table> <p>#12</p> <p><b>PRS 1x</b>   <b>PRS 0x</b>   <b>PRS divider</b></p> <p>0   0   /4   25Hz ... 100Hz</p> <p>0   1   /2   50Hz ... 200Hz</p> <p>1   x   /1   100Hz ... 400Hz</p> <p>#14</p> <p><b>INCR SGN</b>   <b>increment/decrement</b></p> <p>0   decrement</p> <p>1   increment</p> <p>#14</p> <p><b>INCR 1x INCR 0x</b>   <b>increment/decrement</b></p> <p>0   0   no increment/decrement</p> <p>0   1   4 LSB</p> <p>1   0   8 LSB</p> <p>1   1   16 LSB</p>	ONx	INEN1x	INEN0x	GPWM ENx	INx=0	INx=1					OUTx	PWMx	0	x	x	x	OFF	x	0	0	0	0	ON	individual	0	0	1	1	ON	global	0	0	1	0	OFF	individual	0	1	1	1	OFF	global	1	1	0	0	OFF	individual	1	1	0	1	OFF	global	1	1	1	1	ON	global
ONx	INEN1x	INEN0x	GPWM ENx	INx=0	INx=1																																																								
				OUTx	PWMx																																																								
0	x	x	x	OFF	x																																																								
0	0	0	0	ON	individual																																																								
0	0	1	1	ON	global																																																								
0	0	1	0	OFF	individual																																																								
0	1	1	1	OFF	global																																																								
1	1	0	0	OFF	individual																																																								
1	1	0	1	OFF	global																																																								
1	1	1	1	ON	global																																																								

## 5.6.3 SPI Output Register and Bit Descriptions

The first nibble of the 16 Bit data word (D12... D15) serves as address bits.

All register values are logic [0] after a reset, except DSF and RCF bits. The predefined value is off / inactive unless otherwise noted.

Register	SO address					SO data											
	#	D15	D14	D13	D12	D11	D10	D9	D8	D7	D6	D5	D4	D3	D2	D1	D0
not used	0	0	0	0	0	X	X	X	X	X	X	X	X	X	X	X	X
quick status	1	0	0	0	1	FM	DSF	OVLf	OLf	CPF	RCF	CLKF	QSF5	QSF4	QSF3	QSF2	QSF1
CH1 status	2	0	0	1	0	FM	DSF	OVLf	OLf	res	OTS1	OTW1	OC21	OC11	OC01	OLON1	OLOFF1
CH2 status	3	0	0	1	1	FM	DSF	OVLf	OLf	res	OTS2	OTW2	OC22	OC12	OC02	OLON2	OLOFF2
CH3 status	4	0	1	0	0	FM	DSF	OVLf	OLf	res	OTS3	OTW3	OC23	OC13	OC03	OLON3	OLOFF3
CH4 status	5	0	1	0	1	FM	DSF	OVLf	OLf	res	OTS4	OTW4	OC24	OC14	OC04	OLON4	OLOFF4
CH5 status	6	0	1	1	0	FM	DSF	OVLf	OLf	res	OTS5	OTW5	OC25	OC15	OC05	OLON5	OLOFF5
device status	7	0	1	1	1	FM	DSF	OVLf	OLf	res	res	res	TMF	OVF	UVF	SPIF	iLIMP
I/O status	8	1	0	0	0	FM	res	TOGGLE	iIN4	iIN3	iIN2	iIN1	OUT5	OUT4	OUT3	OUT2	OUT1
device ID	9	1	0	0	1	FM	UVF	res	res	DEVID 7	DEVID 6	DEVID 5	DEVID 4	DEVID 3	DEVID 2	DEVID 1	DEVID 0
not used	10	1	0	1	0	X	X	X	X	X	X	X	X	X	X	X	X
not used	11	1	0	1	1	X	X	X	X	X	X	X	X	X	X	X	X
not used	12	1	1	0	0	X	X	X	X	X	X	X	X	X	X	X	X
not used	13	1	1	0	1	X	X	X	X	X	X	X	X	X	X	X	X
not used	14	1	1	1	0	X	X	X	X	X	X	X	X	X	X	X	X
testmode	15	1	1	1	1	X	X	X	X	X	X	X	X	X	X	X	X

<b>QSFx</b> #1 = quick status (OC or OTW or OTS or OLON or OLOFF)	#2-#6	<b>OC2x</b>	<b>OC1x</b>	<b>OC0x</b>	<b>over current status</b>
<b>CLKF</b> #1 = PWM clock fail flag		0	0	0	no overcurrent
<b>RCF</b> #1 = register clear flag		0	0	1	OCH11
<b>CPF</b> #1 = charge pump flag		0	1	0	OCH12
<b>OLf</b> #1-#7 = open load flag (wired or of all OL signals)		0	1	1	OCH13
<b>OVLf</b> #1-#7 = over load flag (wired or of all OC and OTS signals)		1	0	0	OCLO
<b>DSF</b> #1-#7 = device status flag (UVF or OVF or CPF or RCF or CLKF or TMF)		1	0	1	OCH10D
<b>FM</b> #1-#8 = fail mode flag		1	1	0	SSC
<b>OLOFFx</b> #2-#6 = open load in off state status bit		1	1	1	not used
<b>OLONx</b> #2-#6 = open load in on state status bit	#9	<b>DEVID2</b>	<b>DEVID1</b>	<b>DEVID0</b>	<b>device type</b>
<b>OTWx</b> #2-#6 = over temperature warning bit		0	0	0	Penta3/2
<b>OTSx</b> #2-#6 = over temperature shutdown bit		0	0	1	Penta0/5
<b>iLIMP</b> #7 = status of LIMPin after deglitcher (reported in real time)		0	1	0	Quad2/2
<b>SPIF</b> #7 = SPI fail flag		0	1	1	Quad0/4
<b>UVF</b> #7 = under voltage flag		1	0	0	Triple1/2
<b>OVF</b> #7 = over voltage flag		1	0	1	Triple0/3
<b>TMF</b> #7 = testmode activation flag		1	1	0	res
<b>OUTx</b> #8 = status of VPWR/2 comparator (reported in real time)		1	1	1	res
<b>iINx</b> #8 = status of INx pin after deglitcher (reported in real time)					
<b>TOGGLE</b> #8 = status of INx_ON signals (IN1_ON or IN2_ON or IN3_ON or IN4_ON)					
<b>DEVID0 ~ DEVID2</b> #9 = device type					
<b>DEVID3 ~ DEVID4</b> #9 = device family					
<b>DEVID5 ~ DEVID7</b> #9 = design status (incremented number)					

## 5.6.4 Timing Diagrams

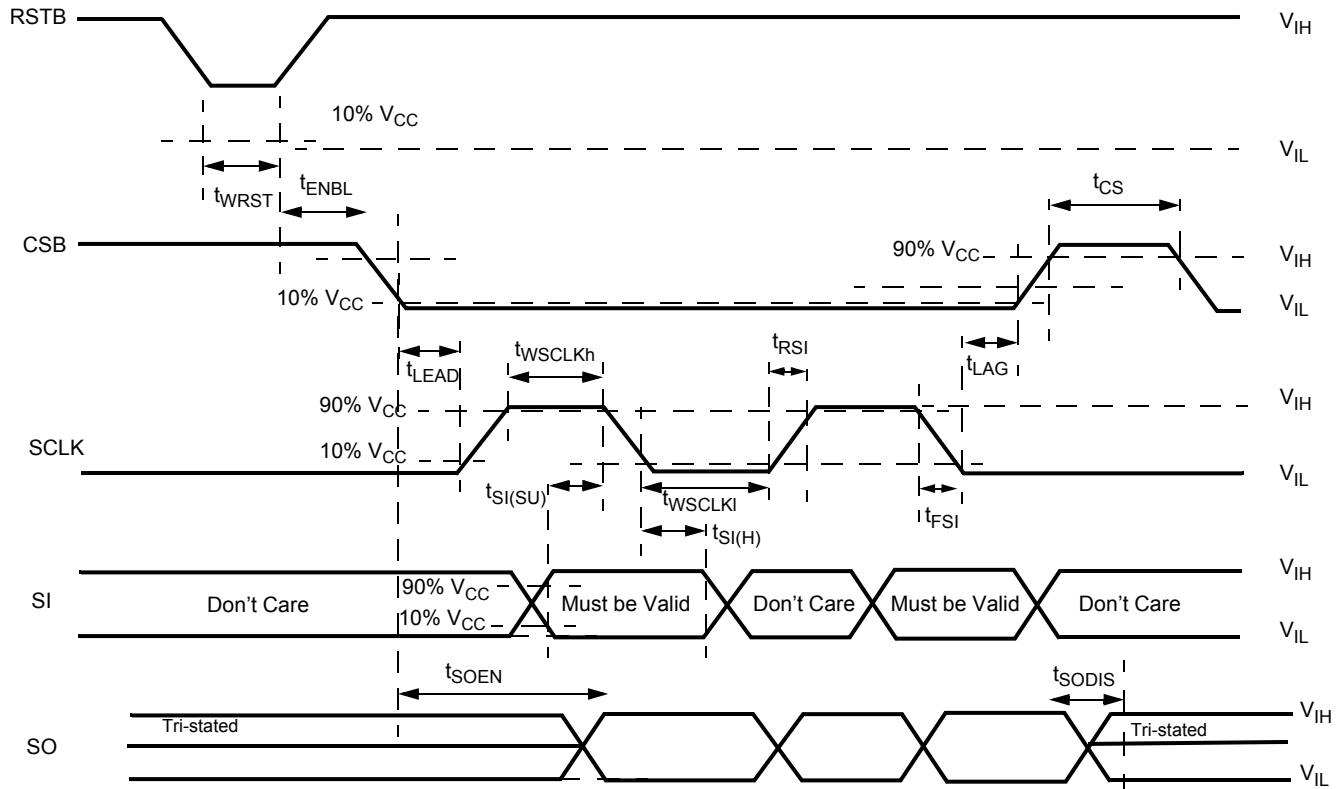

Figure 8. Timing Requirements During SPI Communication

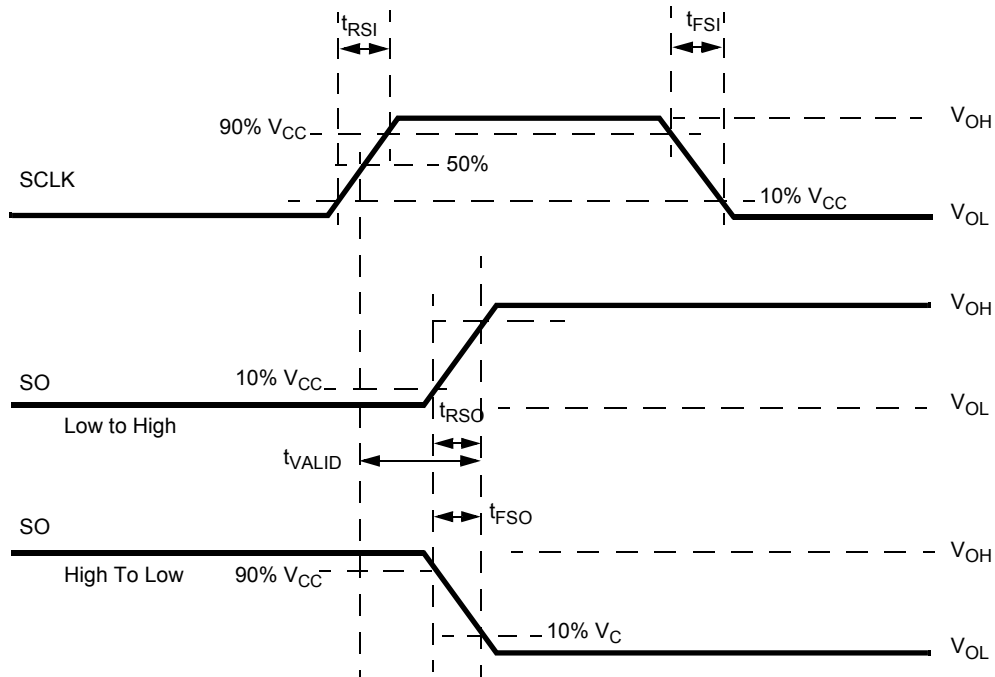

Figure 9. Timing Diagram for Serial Output (SO) Data Communication

## 5.6.5 Electrical Characterization

**Table 7. Electrical Characteristics**

Characteristics noted under conditions  $4.5\text{ V} \leq V_{CC} \leq 5.5\text{ V}$ ,  $-40\text{ }^\circ\text{C} \leq T_A \leq 125\text{ }^\circ\text{C}$ ,  $\text{GND} = 0\text{ V}$ , unless otherwise noted. Typical values noted reflect the approximate parameter means at  $T_A = 25\text{ }^\circ\text{C}$  under nominal conditions, unless otherwise noted.

Symbol	Characteristic	Min	Typ	Max	Unit	Notes
<b>SPI SIGNALS CSB, SI, SO, SCLK, SO</b>						
$f_{\text{SPI}}$	SPI Clock Frequency	0.5	–	5.0	MHz	
$V_{\text{IH}}$	Logic Input High State Level (SI, SCLK, CSB, RSTB)	3.5	–	–	V	
$V_{\text{IH(WAKE)}}$	Logic Input High State Level for wake-up (RSTB)	3.75	–	–	V	
$V_{\text{IL}}$	Logic Input Low State Level (SI, SCLK, CSB, RSTB)	–	–	0.85	V	
$V_{\text{OH}}$	Logic Output High State Level (SO)	$V_{CC} - 0.4$	–	–	V	
$V_{\text{OL}}$	Logic Output Low State Level (SO)	–	–	0.4	V	
$I_{\text{IN}}$	Logic Input Leakage Current in Inactive State (SI = SCLK = RSTB = [0] and CSB = [1])	-0.5	–	+0.5	$\mu\text{A}$	
$I_{\text{OUT}}$	Logic Output Tri-state Leakage Current (SO from 0 V to $V_{CC}$ )	-10	–	+1.0	$\mu\text{A}$	
$R_{\text{PULL}}$	Logic Input Pull-up / Pull-down Resistor	25	–	100	$\text{k}\Omega$	
$C_{\text{IN}}$	Logic Input Capacitance	–	–	20	pF	(16)
$t_{\text{RST\_DGL}}$	RSTB deglitch Time	7.5	10	12.5	$\mu\text{s}$	
$t_{\text{SO}}$	SO Rising and Falling Edges with 80 pF	–	–	20	ns	
$t_{\text{WCLKh}}$	Required High State Duration of SCLK (Required Setup Time)	80	–	–	ns	
$t_{\text{WCLKl}}$	Required Low State Duration of SCLK (Required Setup Time)	80	–	–	ns	
$t_{\text{CS}}$	Required duration from the Rising to the Falling Edge of CSB (Required Setup Time)	1.0	–	–	$\mu\text{s}$	
$t_{\text{RST}}$	Required Low State Duration for reset RST\	1.0	–	–	$\mu\text{s}$	
$t_{\text{LEAD}}$	Falling Edge of CSB to Rising Edge of SCLK (Required Setup Time)	320	–	–	ns	
$t_{\text{LAG}}$	Falling Edge of SCLK to Rising Edge of CSB (Required Setup lag Time)	100	–	–	ns	
$t_{\text{SI(SU)}}$	SI to Falling Edge of SCLK (Required Setup Time)	20	–	–	ns	
$t_{\text{SI(H)}}$	Falling Edge of SCLK to SI (Required hold Time of the SI signal)	20	–	–	ns	
$t_{\text{RSI}}$	SI, CSB, SCLK, Max. Rise Time Allowing Operation at Maximum $f_{\text{SPI}}$	–	20	50	ns	
$t_{\text{FSI}}$	SI, CSB, SCLK, Max. Fall Time Allowing Operation at Maximum $f_{\text{SPI}}$	–	20	50	ns	
$t_{\text{SO(EN)}}$	Time from Falling Edge of CS\ to Reach Low-impedance on SO (access time)	–	–	60	ns	
$t_{\text{SO(DIS)}}$	Time from Rising Edge of CSB to Reach Tri-state on SO	–	–	60	ns	

Notes

16. Parameter is derived from simulations.

# 6 Functional Block Requirements and Behaviors

## 6.1 Self-protected High Side Switches Description and Application Information

### 6.1.1 Features

Up to five power outputs are foreseen to drive light as well as DC motor applications. The outputs are optimized for driving bulbs, but also HID ballasts, LEDs, and other resistive or low inductive loads.

The smart switches are controlled by use of high sophisticated gate drivers. The gate drivers provide:

- output pulse shaping
- output protections
- active clamps
- output diagnostics

### 6.1.2 Output Pulse Shaping

The outputs are controlled with a closed loop active pulse shaping to provide the best compromise between:

- low switching losses
- low EMC emission performance
- minimum propagation delay time

Depending on the programming of the prescaler setting register #12-1, #12-2, the switching speeds of the outputs are adjusted to the output frequency range of each channel.

The edge shaping shall be designed according the following table:

divider factor	PWM freq [Hz]		PWM period [ms]		d.c. range [hex]		d.c. range [LSB]		min. on/off duty cycle time [μs]
	min	max	min	max	min	max	min	max	
4	25	100	10	40	03	FB	4	252	156
2	50	200	5	20	07	F7	8	248	156
1	100	400	2,5	10	07	F7	8	248	78

The edge shaping provides full symmetry for rising and falling transition:

- the slopes for the rising and falling edge are matched to provide the best EMC emission performance
- the shaping of the upper edges and the lower edges are matched to provide the best EMC emission performance
- the propagation delay time for the rising edge and the falling edge is matched to provide true duty cycle control of the output duty cycle error,  $\leq 1$  LSB at max. frequency
- a digital regulation loop is used to minimize the duty cycle error of the output signal

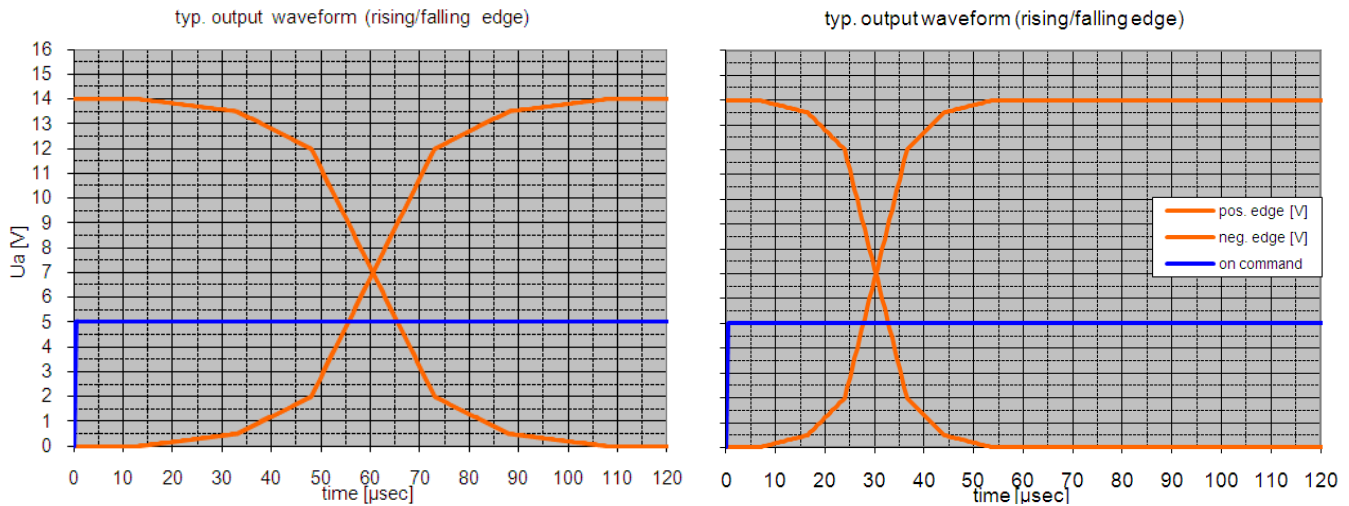

Figure 10. Typical Power Output Switching (slow & fast slew rate)

### 6.1.2.1 SPI Control and Configuration

For optimized control of the outputs, a synchronous clock module is integrated. The PWM frequency and output timing during Normal mode are generated from the clock input (CLK) by the integrated PWM module. In case of clock fail (very low frequency, very high frequency), the output duty cycle is 100%.

Each output (OUT1... OUT6) can be controlled by an individual channel control register:

Register	SI address				SI data												
	#	D15	D14	D13	D12	D11	D10	D9	D8	D7	D6	D5	D4	D3	D2	D1	D0
CHx control	2-7	channel address				WD	PH1x	PH0x	Onx	PWM7x	PWM6x	PWM5x	PWM4x	PWM3x	PWM2x	PWM1x	PWM0x

where:

- PH0x... PH1x: phase assignment of the output channel x
- Onx: on/off control including overcurrent window control of the output channel x
- PWM0x... PWM7x: 8-bit PWM value individually for each output channel x

The ONx bits are duplicated in the output control register #8 to control the outputs with either the CHx control register or the output control register.

The PRS1x... PRS0x prescaler settings can be set in the prescaler settings register #12-1 and #12-2.

The following changes of the duty cycle are performed asynchronous (with pos. edge of CSB signal)

- turn on with 100% duty cycle (CHx = ON)
- change of duty cycle value to 100%
- turn off (CHx = OFF)
- phase setting (PH0x... PH1x)
- prescaler setting (PRS1x... PRS0x)

A change in phase setting or prescaler setting during CHx = ON may cause an unwanted long ON-time. Therefore it is recommended to turn off the output(s) before execution of this change.

#### INCR SGN increment/decrement

0 decrement

1 increment

The following changes of the duty cycle are performed synchronous (with the next PWM cycle)

- turn on with less than 100% duty cycle (OUTx = ONx)
- change of duty cycle value to less than 100%

A change of the duty cycle value can be achieved by a change of the

- PWM0x... PWM7x bits in individual channel control register #2... #7
- GPWM EN1... GPWM EN6 bits (change between individual PWM and global PWM settings) in global PWM control register #9-1
- incremental/decremental register #14

The synchronization of the switching phases between different devices is provided by the PWM SYNC bit in the initialization 2 register #1.

On a SPI write into initialization 2 register (#1):

- initialization when the bit D1 (PWM SYNC) is logic[1], all counters of the PWM module are reset with the positive edge of the CSB, i.e. the phase synchronization is performed immediately within one SPI frame. It could help to synchronize different Gen4 devices in the board.
- when the bit D1 is logic[0], no action is executed

The switching frequency can be adjusted for the corresponding channel as described in the following table:

CLK freq. [kHz]		prescaler setting		divider	PWM freq [Hz]		slew	PWM resolution	
min.	max.	PRS1x	PRS0x	factor	min	max	rate	[Bit]	[steps]
25,6	102,4	0	0	4	25	100	slow	8	256
		0	1	2	50	200	slow		
		1	X	1	100	400	fast		

PWM duty cycle			pulse skipping frame							
hex	dec	[%]	S0	S1	S2	S3	S4	S5	S6	S7
<b>FF</b>	256	<b>100,00%</b>	FF	FF	FF	FF	FF	FF	FF	FF
<b>FE</b>	255	<b>99,61%</b>	F7	FF	FF	FF	FF	FF	FF	FF
<b>FD</b>	254	<b>99,22%</b>	F7	FF	FF	FF	F7	FF	FF	FF
<b>FC</b>	253	<b>98,83%</b>	F7	FF	F7	FF	F7	FF	FF	FF
<b>FB</b>	252	<b>98,44%</b>	F7	FF	F7	FF	F7	FF	F7	FF
<b>FA</b>	251	<b>98,05%</b>	F7	F7	F7	FF	F7	FF	F7	FF
<b>F9</b>	250	<b>97,66%</b>	F7	F7	F7	FF	F7	F7	F7	FF
<b>F8</b>	249	<b>97,27%</b>	F7	F7	F7	F7	F7	F7	F7	FF
<b>F7</b>	248	<b>96,88%</b>								
<b>F6</b>	247	<b>96,48%</b>								
<b>F5</b>	246	<b>96,09%</b>								
<b>F4</b>	245	<b>95,70%</b>								
.	.	.								
.	.	.								
.	.	.								
<b>03</b>	4	<b>1,56%</b>								
<b>02</b>	3	<b>1,17%</b>								
<b>01</b>	2	<b>0,78%</b>								
<b>00</b>	1	<b>0,39%</b>								

No PWM feature is provided in case of:

- Fail mode
- clock input signal failure

### 6.1.2.2 Global PWM Control

In addition to the individual PWM register, each channel can be assigned independently to a global PWM register.

The setting is controlled by the GPWM EN bits inside the global PWM control register #9-1. When no control by direct input pin is enabled and the GPWM EN bit is

- low (logic[0]), the output is assigned to individual PWM (default status)
- high (logic[1]), the output is assigned to global PWM

The PWM value of the global PWM channel is controlled by the global PWM control register #9-2.



ON <sub>x</sub>	INEN1 <sub>x</sub>	INEN0 <sub>x</sub>	GPWM EN <sub>x</sub>	iIN <sub>x</sub> =0		iIN <sub>x</sub> =1	
				CH <sub>x</sub>	PWM <sub>x</sub>	CH <sub>x</sub>	PWM <sub>x</sub>
0	x	x	x	OFF	x	OFF	x
1	0	0	0	ON	<i>individual</i>	ON	<i>individual</i>
			1	ON	<i>global</i>	ON	<i>global</i>
	1	0	0	OFF	<i>individual</i>	ON	<i>individual</i>
			1	OFF	<i>global</i>	ON	<i>global</i>
	1	1	0	ON	<i>individual</i>	ON	<i>global</i>
			1	ON	<i>global</i>	ON	<i>individual</i>

When a channel is assigned to global PWM, the switching phase the prescaler and the pulse skipping are according the corresponding output channel setting.

### 6.1.2.3 Incremental PWM Control

To reduce the control overhead during soft start/stop of bulbs or DC motors (e.g. theatre dimming), an incremental PWM control feature is implemented.

With the incremental PWM control feature the PWM values of all internal channels OUT1... OUT5 can be incremented or decremented with one SPI frame.

The incremental PWM feature is not available for

- the global PWM channel
- the external channel OUT6

The control is according the increment/decrement register #14:

- INCR SGN: sign of incremental dimming (valid for all channels)
- INCR 1x, INCR 0x increment/decrement

INCR 1x	INCR 0x	increment/decrement
0	0	<i>no increment/decrement</i>
0	1	4
1	0	8
1	1	16

This feature limits the duty cycle to the rails (00 resp. FF) to avoid any overflow.

### 6.1.2.4 Pulse Skipping

Due to the output pulse shaping feature and the resulting switching delay time of the smart switches, duty cycles close to 0% resp. 100% can not be generated by the device. Therefore the pulse skipping feature (PSF) is integrated to interpolate this output duty cycle range in Normal mode.

The pulse skipping provides a fixed duty cycle pattern with eight states to interpolate the duty cycle values between F7 (Hex) and FF (Hex). The range between 00 (Hex) and 07 (Hex) is not considered to be provided.

The pulse skipping feature

- is available individually for the power output channels (OUT1... OUT5)
- is not available for the external channel (OUT6).

The feature is enabled with the PSF bits in the output control register #8.

When the corresponding PSF bit is

- low (logic[0]), the pulse skipping feature is disabled on this channel (default status)
- high (logic[1]), the pulse skipping feature is enabled on this channel

## 6.1.2.5 Input Control

Up to four dedicated control inputs (IN1... IN4) are foreseen to

- wake-up the device
- fully control the corresponding output in case of Fail mode
- control the corresponding output in case of Normal mode

The control during Normal mode is according the INEN0x and INEN1x bits in the input enable register #11 and according following logic table:

An input deglitcher is provided at each control input to avoid high frequency control of the outputs. The internal signal is called iINx.

The channel control (CHx) can be summarized:

- Normal mode:
  - CH1... 4 controlled by ONx or INx (if it is programmed by the SPI)
  - CH5... 6 controlled by ONx
  - Rising CHx by definition means starting overcurrent window for OUT1... 5
- Fail mode:
  - CH1... 4 controlled by iINx, while the over current windows are controlled by IN\_ONx
  - CH5... 6 are off

Even so, the input thresholds are logic level compatible, the input structure of the pins shall be able to withstand supply voltage level (max.40 V) without damage. External current limit resistors (i.e. 1.0 k...10 k) can be used to handle reverse current conditions.

The inputs have an integrated pull-down resistor.

## 6.1.2.6 Electrical Characterization

**Table 8. Electrical Characteristics**

Characteristics noted under conditions  $7.0\text{ V} \leq V_{PWR} \leq 18\text{ V}$ ,  $-40\text{ }^{\circ}\text{C} \leq T_A \leq 125\text{ }^{\circ}\text{C}$ ,  $\text{GND} = 0\text{ V}$ , unless otherwise noted. Typical values noted reflect the approximate parameter means at  $T_A = 25\text{ }^{\circ}\text{C}$  under nominal conditions, unless otherwise noted.

Symbol	Characteristic	Min	Typ	Max	Unit	Notes
<b>POWER OUTPUTS OUT1... OUT5</b>						
$R_{DS(ON)}$	ON-Resistance, Drain-to-Source for 7mΩ Power Channel <ul style="list-style-type: none"> <li>• <math>T_J = 25\text{ }^{\circ}\text{C}</math>, <math>V_{PWR} \geq 12\text{ V}</math></li> <li>• <math>T_J = 150\text{ }^{\circ}\text{C}</math>, <math>V_{PWR} \geq 12\text{ V}</math></li> <li>• <math>T_J = 25\text{ }^{\circ}\text{C}</math>, <math>V_{PWR} = 7.0\text{ V}</math></li> <li>• <math>T_J = 25\text{ }^{\circ}\text{C}</math>, <math>V_{PWR} = -12\text{ V}</math></li> <li>• <math>T_J = 150\text{ }^{\circ}\text{C}</math>, <math>V_{PWR} = -12\text{ V}</math></li> </ul>	–	7.0	8.0	mΩ	
$R_{DS(ON)}$	ON-Resistance, Drain-to-Source for 17 mΩ Power Channel <ul style="list-style-type: none"> <li>• <math>T_J = 25\text{ }^{\circ}\text{C}</math>, <math>V_{PWR} \geq 12\text{ V}</math></li> <li>• <math>T_J = 150\text{ }^{\circ}\text{C}</math>, <math>V_{PWR} \geq 12\text{ V}</math></li> <li>• <math>T_J = 25\text{ }^{\circ}\text{C}</math>, <math>V_{PWR} = 7.0\text{ V}</math></li> <li>• <math>T_J = 25\text{ }^{\circ}\text{C}</math>, <math>V_{PWR} = -12\text{ V}</math></li> <li>• <math>T_J = 150\text{ }^{\circ}\text{C}</math>, <math>V_{PWR} = -12\text{ V}</math></li> </ul>	–	17	19	mΩ	
$I_{LEAK\ SLEEP}$	Sleep Mode Output Leakage Current (Output shorted to GND) per Channel <ul style="list-style-type: none"> <li>• <math>T_J = 25\text{ }^{\circ}\text{C}</math>, <math>V_{PWR} = 12\text{ V}</math></li> <li>• <math>T_J = 125\text{ }^{\circ}\text{C}</math>, <math>V_{PWR} = 12\text{ V}</math></li> <li>• <math>T_J = 25\text{ }^{\circ}\text{C}</math>, <math>V_{PWR} = 35\text{ V}</math></li> <li>• <math>T_J = 125\text{ }^{\circ}\text{C}</math>, <math>V_{PWR} = 35\text{ V}</math></li> </ul>	–	–	0.5	μA	
		–	–	5.0		
		–	–	5.0		
		–	–	25		

**Table 8. Electrical Characteristics**

Characteristics noted under conditions  $7.0\text{ V} \leq V_{PWR} \leq 18\text{ V}$ ,  $-40\text{ }^\circ\text{C} \leq T_A \leq 125\text{ }^\circ\text{C}$ ,  $\text{GND} = 0\text{ V}$ , unless otherwise noted. Typical values noted reflect the approximate parameter means at  $T_A = 25\text{ }^\circ\text{C}$  under nominal conditions, unless otherwise noted.

Symbol	Characteristic	Min	Typ	Max	Unit	Notes
<b>POWER OUTPUTS OUT1... OUT5 (Continued)</b>						
$I_{OUT\ OFF}$	Operational Output Leakage Current in OFF-State per Channel <ul style="list-style-type: none"> <li><math>T_J = 25\text{ }^\circ\text{C}</math>, <math>V_{PWR} = 18\text{ V}</math></li> <li><math>T_J = 125\text{ }^\circ\text{C}</math>, <math>V_{PWR} = 18\text{ V}</math></li> </ul>	– –	– –	10 20	$\mu\text{A}$	
$\delta_{PWM}$	Output PWM Duty Cycle Range (measured at $V_{OUT} = V_{PWR}/2$ ) <ul style="list-style-type: none"> <li>Low Frequency Range (25 to 100 Hz)</li> <li>Medium Frequency Range (50 to 200 Hz)</li> <li>High Frequency Range (100 to 400 Hz)</li> </ul>	4.0 8.0 8.0	– – –	252 248 248	LSB	
SR	Rising and Falling Edges Slew-Rate at $V_{PWR} = 14\text{ V}$ (measured from $V_{OUT} = 2.5\text{ V}$ to $V_{PWR} - 2.5\text{ V}$ ) <ul style="list-style-type: none"> <li>Low Frequency Range</li> <li>Medium Frequency Range</li> <li>High Frequency Range</li> </ul>	0.25 0.25 0.55	0.42 0.42 0.84	0.6 0.6 1.25	$\text{V}/\mu\text{s}$	(17)
$\Delta\text{SR}$	Rising and Falling Edges Slew Rate Matching at $V_{PWR} = 14\text{ V}$ ( $\text{SR}_r / \text{SR}_f$ )	0.9	1.0	1.1		(17)
$t_{DLY}$	Turn-on and Turn-off Delay Times at $V_{PWR} = 14\text{ V}$ <ul style="list-style-type: none"> <li>Low Frequency Range</li> <li>Medium Frequency Range</li> <li>High Frequency Range</li> </ul>	20 20 10	60 60 30	100 100 50	$\mu\text{s}$	(17)
$\Delta t_{DLY}$	Turn-on and Turn-off Delay Times Matching at $V_{PWR} = 14\text{ V}$ <ul style="list-style-type: none"> <li>Low Frequency Range</li> <li>Medium Frequency Range</li> <li>High Frequency Range</li> </ul>	-20 -20 -10	0.0 0.0 0.0	20 20 10	$\mu\text{s}$	(17)
$t_{OUTPUT\ SD}$	Shutdown Delay Time in case of Fault	0.5	2.5	4.5	$\mu\text{s}$	
<b>REFERENCE PWM CLOCK</b>						
$f_{CLK}$	Clock Input Frequency Range	25.6	–	102.4	$\text{kHz}$	

**Notes**

17. With nominal resistive load: 2.5  $\Omega$  and 5.0  $\Omega$  respectively for 7.0 m $\Omega$  and 17 m $\Omega$  channel.

### 6.1.3 Output Protections

The power outputs are protected against fault conditions in Normal and Fail mode in case of

- overload conditions
- harness short-circuit
  - overcurrent protection against ultra-low resistive short-circuit conditions thanks to smart overcurrent profile & severe short-circuit protection
- overtemperature protection including overtemperature warning
- under and overvoltage protections
- charge pump monitoring
- reverse supply protection

In case a fault condition is detected, the corresponding output is commanded off immediately after the deglitch time  $t_{FAULT\ SD}$ . The turn off in case of a fault shutdown (OCHI1, OCHI2, OCHI3, OCLO, OTS, UV, CPF, OLOFF) is provided by the FTO feature (fast turn off).

The FTO:

- does not use edge shaping
- is provided with high slew rate to minimize the output turn-off time  $t_{\text{OUTPUT SD}}$ , in regards to the detected fault
- uses a latch which keeps the FTO active during an undervoltage condition ( $0 \leq V_{\text{PWR}} \leq V_{\text{PWR UVF}}$ )

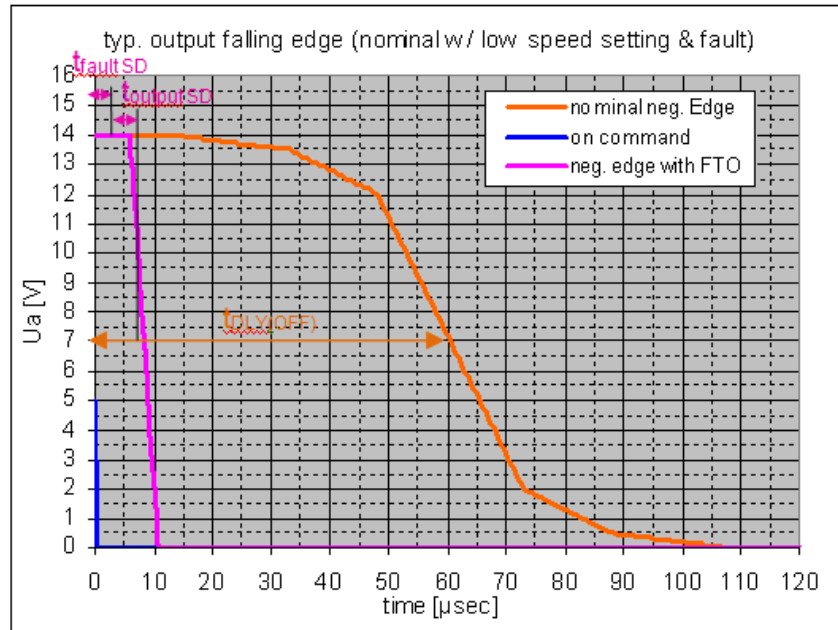

Figure 11. Power Output Switching in Nominal Operation and In Case of Fault

Normal mode

In case of a fault condition during Normal mode

- the status is reported in the quick status register #1 and the corresponding channel status register #2... #6.

To restart the output

- the channel must be restarted by writing the corresponding ON bit in the channel control register #2... #6 or output control register #8.

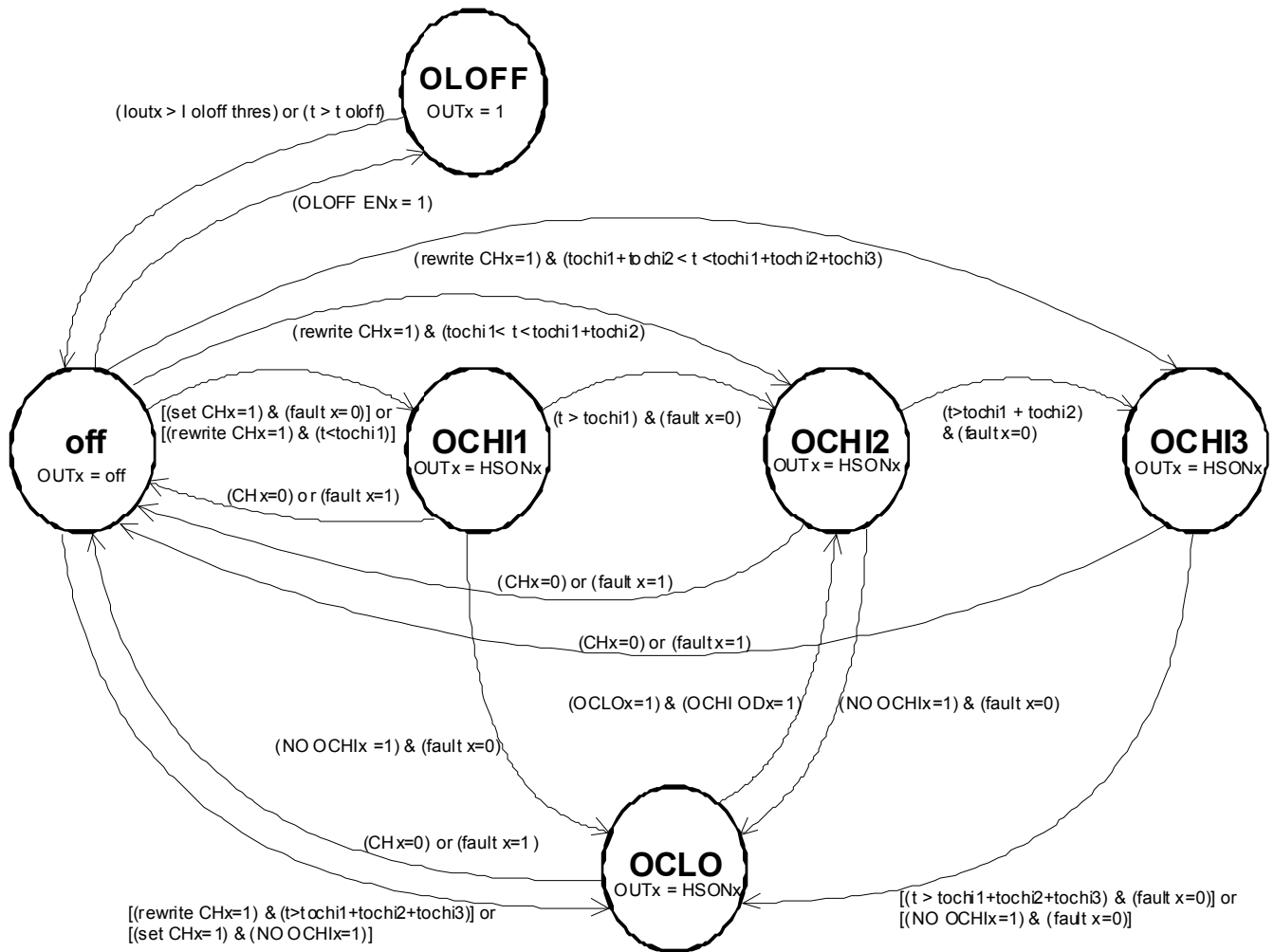

Definitions of key logic signals:

(fault x):= (UV) or (OCHI1x) or (OCHI2x) or (OCHI3x) or (OCLOx) or (OTx) or (SSCx)

(set CHx=1):= [(ONx=0) then (ONx=1)]

(rewrite CHx=1):= (rewrite ONx=1) after (fault x=1)

SSCx:= severe short circuit detection

**Figure 12. Output Control Diagram in Normal Mode**

**Fail mode**

In case of an overcurrent (OCHI2, OCHI3, OCLO) or undervoltage, the restart is controlled by the autorestart feature

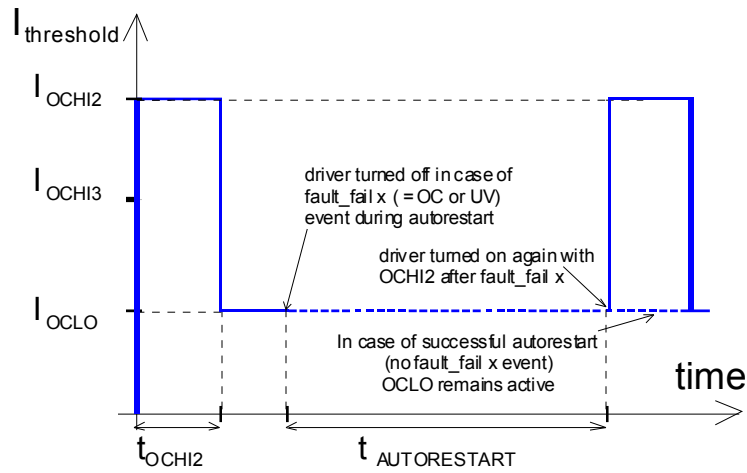

**Figure 13. Autorestart in Fail Mode**

In case of overtemperature (OTSx), severe short-circuit (SSCx), or OCHI1 overcurrent, the corresponding output enters latch off state until the next wake-up cycle or mode change.

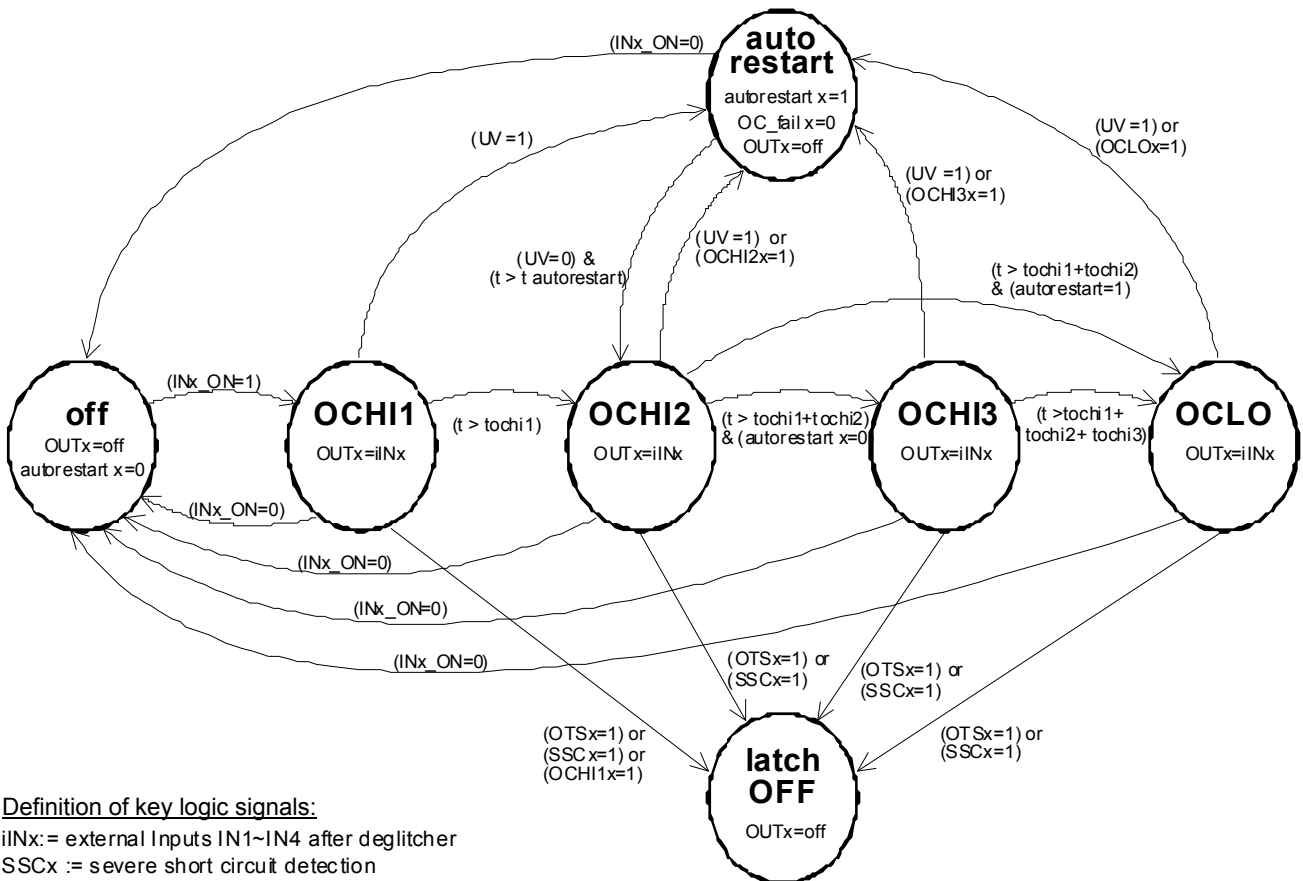

Definition of key logic signals:

$i\text{IN}_x$  := external Inputs  $\text{IN}_1 \sim \text{IN}_4$  after deglitcher  
 $\text{SSC}_x$  := severe short circuit detection

**Figure 14. Output Control Diagram in Fail Mode**

### 6.1.3.1 Overcurrent Protections

Each output channel is protected against overload conditions by use of a multilevel overcurrent shutdown.

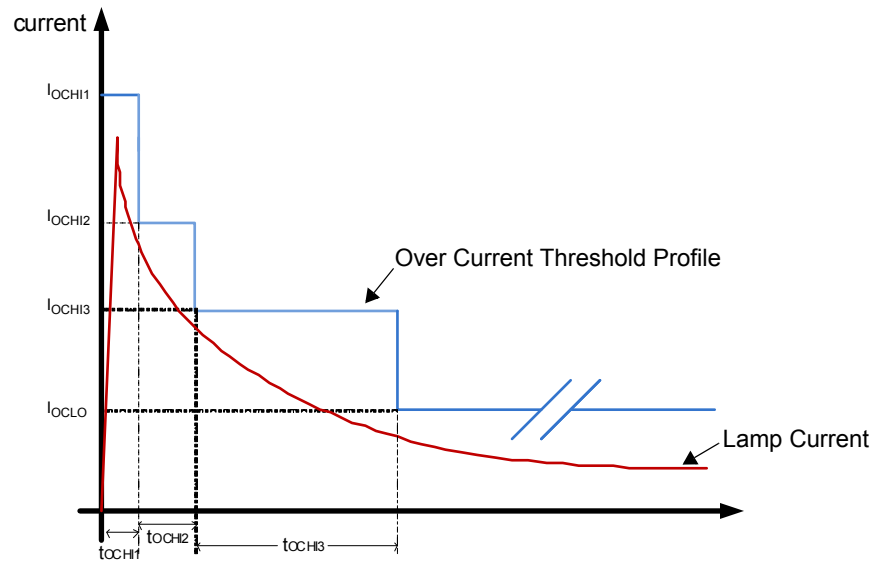
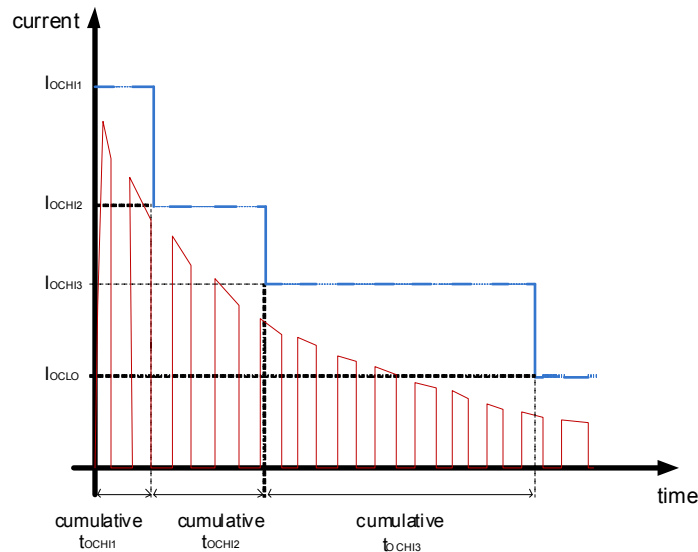

**Figure 15. Transient Overcurrent Profile**

The current thresholds and the threshold window times are fixed for each type of power channel.

When the output is in PWM mode, the clock for the OCHI time counters ( $t_{OCHI1} \dots t_{OCHI3}$ ) is gated (logic AND) with the referring output control signal:

- the clock for the  $t_{OCHI}$  counter is activated when the output = [1] respectively CHx = 1
- the clock for the  $t_{OCHI}$  counter is stopped when the output = [0] respectively CHx = 0



**Figure 16. Transient Over Current Profile in PWM mode**

This strategy counts the OCHI time only when the bulb is actually heated up. The window counting is stopped in case of UV, CPF and OTS.

A severe short-circuit protection (SSC) is implemented in order to limit the power dissipation in Normal and Fail modes, in case of severe short-circuit event. This feature is active only for a very short period of time, during OFF-to-ON transition. The load impedance is monitored during the output turn-on.

Normal mode

The enabling of the high current window (OCHI1... OCHI3) is dependent on CHx signal.

When no control input pin is enabled, the control of the over current window depends on the ON bits inside channel control registers #2... #7 or the output control register #8.

When the corresponding CHx signal is

- toggled (turn OFF and then ON), the OCHI window counter is reset and the full OCHI windows are applied

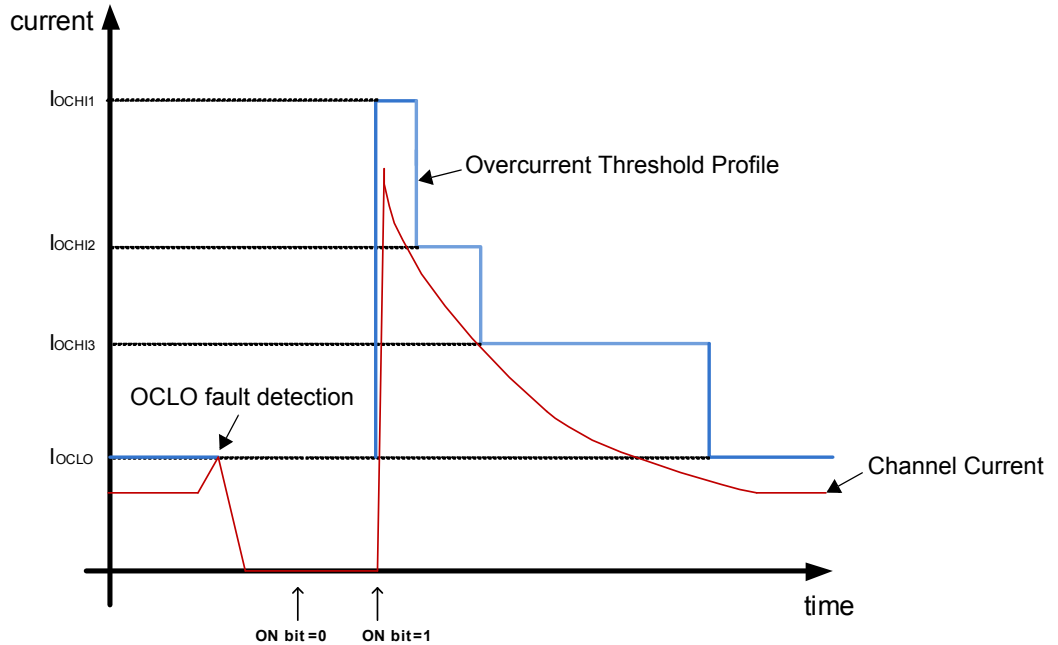

**Figure 17. Resettable Overcurrent Profile**

- rewritten (logic [1]), the OCHI window time is proceeding without reset of the OCHI counter

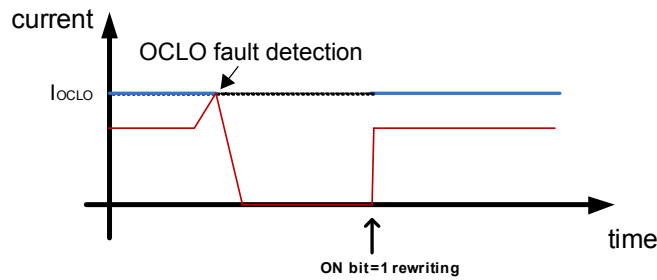

**Figure 18. Overcurrent Level Fixed to OCLO**

Fail mode

The enabling of the high current window (OCHI1... OCHI3) is dependent on INx\_ON toggle signal.

The enabling of output (OUT1... 5) is dependent on CHx signal.



### 6.1.3.1.1 Over Current Control Programming

A set of overcurrent control programming functions are implemented to provide a flexible and robust system behavior:

HID Ballast Profile (NO\_HID)

A smart overcurrent window control strategy is implemented to turn on an HID ballast, even in the case of a long power on reset time.

When the output is in 100% PWM mode (including PWM clock failure in Normal mode and  $iINx=1$  in Fail mode), the clock for the OCHI2 time counter is divided by 8, when no load current is demanded from the output driver.

- the clock for the  $t_{OCHI2}$  counter is divided by 8 when the open load signal is high (logic[1]), to accommodate the HID ballast while in power on reset mode
- the clock for the  $t_{OCHI2}$  counter is connected directly to the window time counter when the OpenLoad signal is low (logic[0]), to accommodate the HID demanding load current from the output

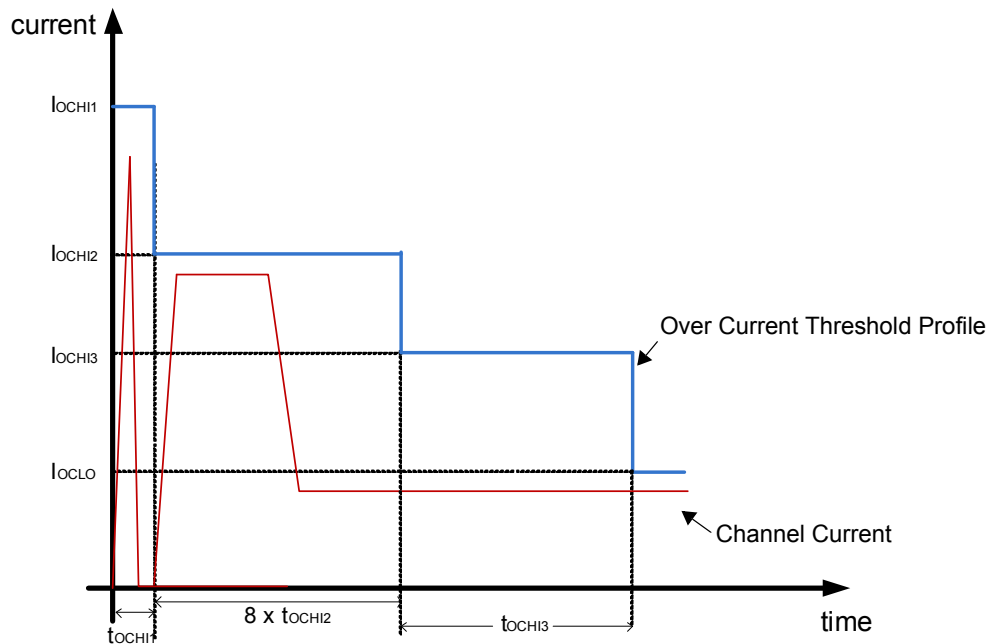

**Figure 19. HID Ballast Overcurrent Profile**

This feature extends the OCHI2 time, depending on the status of the HID ballast, and ensures to bypass even a long power on reset time of HID ballast. Nominal  $t_{OCHI2}$  duration is up to 64 ms (instead of 8.0 ms).

This feature is automatically active at the beginning of smart overcurrent window, except for OCHI On Demand as described by the following.

The functionality is controlled by the NO\_HID1 and NO\_HID0 bits inside the initialization #2 register.

When the NO\_HID1 and NO\_HID0 bits are respectively:

- [0 0]: smart HID feature is available for all channels (default status and during Fail mode)
- [0 1]: smart HID feature is available for channel 3 only
- [1 0]: smart HID feature is available for channels 3 and 4 only
- [1 1]: smart HID feature is not available for any channel

OCHI On Demand (OCHI OD)

In some instances, a lamp might be de-powered when its supply is interrupted by the opening of a switch (as in a door), or by disconnecting the load (as in a trailer harness). In these cases, the driver should be tolerant of the inrush current that will occur when the load is reconnected. The OCHI On Demand feature allows such control individually for each channel through the OCHI ODx bits inside the Initialization #2 register.

When the OCHI ODx bit is:

- low (logic[0]), the channel operates in its Normal, Default mode. After end of OCHI window timeout the output is protected with an OCLO threshold
- high (logic[1]), the channel operates in the OCHI On Demand mode and uses the OCHI2 and OCHI3 windows and times after an OCLO event

To reset the OCHI ODx bit (logic[0]) and change the response of the channel, first change the bit in the Initialization #2 register and then turn the channel off. The OCHI ODx bit is also reset after an overcurrent event at the corresponding output.

The fault detection status is reported in the quick status register #1 and the corresponding channel status registers #2... #6, as presented in [Figure 20](#).

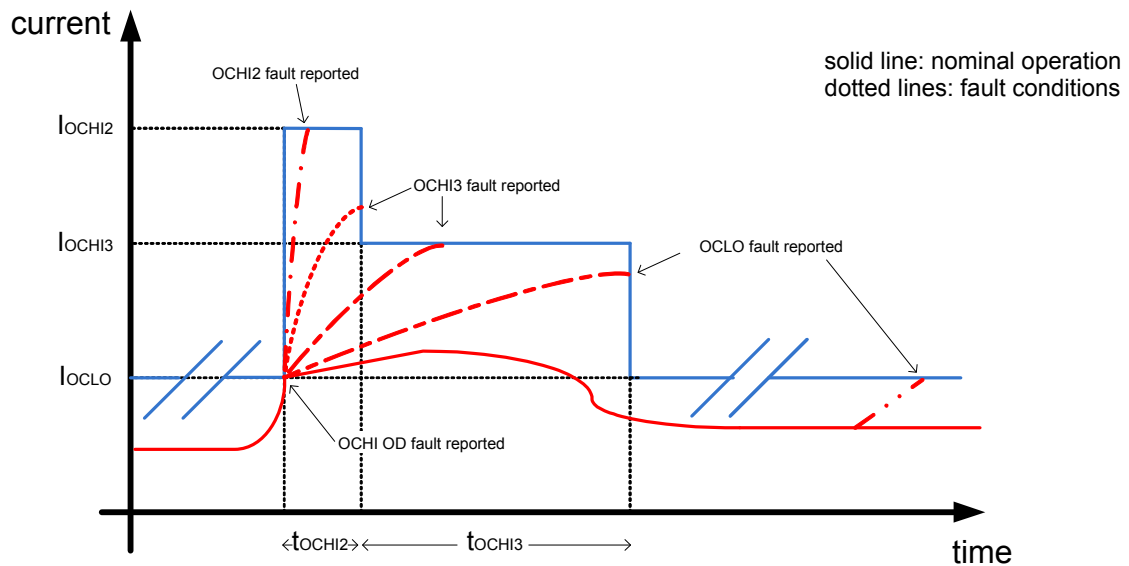

**Figure 20. OCHI On Demand Profile**

#### OCLO Threshold Setting

The static overcurrent threshold can be programmed individually for each output in two levels to adapt low duty cycle dimming and a variety of loads.

The CSNS recopy factor and OCLO threshold depend on OCLO and ACM settings.

The OCLO setting is controlled by the OCLOx bits inside the overcurrent control register #10-1.

When the OCLOx bit is

- low (logic[0]), the output is protected with the higher OCLO threshold (default status and during Fail mode)
- high (logic[1]), the lower OCLO threshold is applied

#### SHORT OCHI

The length of the OCHI windows can be shortened by a factor of 2, to accelerate the availability of the CSNS diagnosis and to reduce the potential stress inside the switch during an overload condition.

The setting is controlled individually for each output by the SHORT OCHIx bits inside the overload control register #10-2.

When the SHORT OCHIx bit is

- low (logic[0]), the default OCHI window times are applied (default status and during Fail mode)
- high (logic[1]), the short OCHI window times are applied (50% of the regular OCHI window time)

#### NO OCHI

The switch on process of an output can be done without an OCHI window, to accelerate the availability of the CSNS diagnosis.

The setting is controlled individually for each channel by the NO OCHIx bits inside the overcurrent control register #10-2.

When the NO OCHIx bit is

- low (logic[0]), the regular OCHI window is applied (default status and during Fail mode)
- high (logic[1]), the turn on of the output is provided without OCHI windows

The NO OCHI bit is applied in real time. The OCHI window is left immediately when the NO OCHI is high (logic[1]).

The overcurrent threshold is set to OCLO when:

- the NO OCHx bit is set to logic [1] while CHx is ON or
- CHx turns ON if NO OCHx is already set

#### THERMAL OCHI

To minimize the electro-thermal stress inside the device in case of a short-circuit, the OCHI1 level can be automatically adjusted in regards to the control die temperature.

The functionality is controlled for all channels by the OCHI THERMAL bit inside the initialization 2.

When the OCHI THERMAL bit is:

- low (logic[0]), the output is protected with default OCHI1 level
- high (logic[1]), the output is protected with the OCHI1 level reduced by  $R_{THERMAL\ OCHI} = 15\%$  (typ) when the control die temperature is above  $T_{THERMAL\ OCHI} = 63\text{ °C}$  (typ)

#### TRANSIENT OCHI

To minimize the electro-thermal stress inside the device in case of a short-circuit, the OCHx levels can be dynamically evaluated during the OFF-to-ON output transition.

The functionality is controlled for all channels by the OCHI TRANSIENT bit inside the initialization 2 register.

When the OCHI TRANSIENT bit is:

- low (logic[0]), the output is protected with default OCHx levels
- high (logic[1]), the output is protected with an OCHx levels depending on the output voltage ( $V_{OUT}$ ):
  - OCHx level reduced by  $R_{TRANSIENT\ OCHI} = 50\%$  typ for  $0 \leq V_{OUT} < V_{OUT\ DETECT}$  ( $V_{PWR} / 2$  typ),
  - Default OCHx level for  $V_{OUT\ DETECT} \leq V_{OUT}$

In case the resistive load is less than  $V_{PWR}/I_{OCHI1}$ , the overcurrent threshold will be exceeded before output reaches  $V_{PWR} / 2$ , and the output current reaches  $I_{OCHI1}$ . The output is then switched off at much lower and safer currents.

When the load has significant series inductance, the output current transition falls behind voltage with  $L_{LOAD}/R_{LOAD}$  constant time. The intermediate overcurrent threshold could not reach and the output current continues to rise up to OCHx levels.

### 6.1.3.1.2 Electrical Characterization

**Table 9. Electrical Characteristics**

Characteristics noted under conditions  $7.0V \leq V_{PWR} \leq 18V$ ,  $-40\text{ °C} \leq T_A \leq 125\text{ °C}$ ,  $GND = 0V$ , unless otherwise noted. Typical values noted reflect the approximate parameter means at  $T_A = 25\text{ °C}$  under nominal conditions, unless otherwise noted.

Symbol	Characteristic	Min	Typ	Max	Unit	Notes
<b>POWER OUTPUTS OUT1... OUT5</b>						
$I_{OCHI1}$	High Overcurrent Level 1 for 7.0 mΩ Power Channel • $T_J = -40\text{ °C}$ and $25\text{ °C}$ • $T_J = 150\text{ °C}$	100 96	111 106	126.5 126.5	A	
$I_{OCHI2}$	High Overcurrent Level 2 for 7.0 mΩ Power Channel • $T_J = -40\text{ °C}$ and $25\text{ °C}$ • $T_J = 150\text{ °C}$	61.2 60	70 69	77.5 77.5	A	
$I_{OCHI3}$	High Overcurrent Level 3 for 7.0 mΩ Power Channel	34	39	43.5	A	
$I_{OCLO}$	Low Overcurrent for 7.0 mΩ Power Channel • High Level • Low Level	17.6 8.8	21.9 10.8	26.4 13.2	A	
$I_{OCLO\ ACM}$	Low Overcurrent for 7.0 mΩ Power Channel in ACM Mode • High Level • Low Level	8.8 4.4	10.8 5.5	13.2 6.6	A	
$I_{OCHI1}$	High Overcurrent Level 1 for 17 mΩ Power Channel • $T_J = -40\text{ °C}$ and $25\text{ °C}$ • $T_J = 150\text{ °C}$	42 40	48 46	54.4 54.4	A	

**Table 9. Electrical Characteristics**

Characteristics noted under conditions  $7.0V \leq V_{PWR} \leq 18V$ ,  $-40^{\circ}C \leq T_A \leq 125^{\circ}C$ ,  $GND = 0V$ , unless otherwise noted. Typical values noted reflect the approximate parameter means at  $T_A = 25^{\circ}C$  under nominal conditions, unless otherwise noted.

Symbol	Characteristic	Min	Typ	Max	Unit	Notes
<b>POWER OUTPUTS OUT1... OUT5 (Continued)</b>						
$I_{OCHI2}$	High Overcurrent Level 2 for 17 m $\Omega$ Power Channel	24.5	28.2	32.2	A	
$I_{OCHI3}$	High Overcurrent Level 3 for 17 m $\Omega$ Power Channel	14.8	17.3	19.5	A	
$I_{OCLO}$	Low Overcurrent for 17 m $\Omega$ Power Channel • High Level • Low Level	8.8	10.8	13.2	A	
		4.4	5.3	6.6		
$I_{OCLO\ ACM}$	Low Overcurrent for 17 m $\Omega$ Power Channel in ACM Mode • High Level • Low Level	4.4	5.3	6.6	A	
		2.2	2.6	3.3		
$R_{TRANSIENT\ OCHI}$	High Overcurrent Ratio 1	0.45	0.5	0.55		
$R_{THERMAL\ OCHI}$	High Overcurrent Ratio 2	0.835	0.85	0.865		
$T_{THERMAL\ OCHI}$	Temperature Threshold for IOCHI1 Level Adjustment	50	63	70	$^{\circ}C$	
$t_{OCHI1}$	High Overcurrent Time 1 • Default Value • SHORT OCHI option	1.5	2.0	2.5	ms	
		0.75	1.0	1.25		
$t_{OCHI2}$	High Overcurrent Time 2 • Default Value • SHORT OCHI option	6.0	8.0	10	ms	
		3.0	4.0	5.0		
$t_{OCHI3}$	High Overcurrent Time 3 • Default Value • SHORT OCHI option	48	64	80	ms	
		24	32	40		
$R_{SC\ MIN}$	Minimum Severe Short-circuit Detection • 7.0 m $\Omega$ Power Channel • 17 m $\Omega$ Power Channel	5.0	–	–	m $\Omega$	
		10	–	–		
$t_{fault\ SD}$	Fault Deglitch Time • OCLO and OCHI OD • OCHI1... 3 and SSC	1.0	2.0	3.0	$\mu s$	(18)
		1.0	2.0	3.0		
$t_{autorestart}$	Fault Autorestart Time in Fail Mode	48	64	80	ms	
$t_{BLANKING}$	Fault Blanking Time after Wake-up	–	50	100	$\mu s$	

Notes

18. Guaranteed by testmode.

### 6.1.3.2 Overtemperature Protection

A dedicated temperature sensor is located on each power transistor, to protect the transistors and provide SPI status monitoring. The protection is based on a two stage strategy.

When the temperature at the sensor exceeds the:

- selectable overtemperature warning threshold ( $T_{OTW1}$ ,  $T_{OTW2}$ ), the output stays on and the event is reported in the SPI
- overtemperature threshold ( $T_{OTS}$ ), the output is switched off immediately after the deglitch time  $t_{FAULT\ SD}$  and the event is reported in the SPI after the deglitch time  $t_{FAULT\ SD}$ .

### 6.1.3.2.1 Overtemperature Warning (OTW)

In case of overtemperature warning:

- the output remains in current state
- the status is reported in the quick status register #1 and the corresponding channel status register #2... #6

The OTW threshold can be selected by the OTW SEL bit inside the initialization 2 register #1.

When the bit is:

- low (logic[0]), the high overtemperature threshold is enabled (default status)
- high (logic[1]), the low overtemperature threshold is enabled

To delatch the OTW bit (OTWx):

- the temperature has to drop below the corresponding overtemperature warning threshold
- a read command of the corresponding channel status register #2... #6 must be performed

### 6.1.3.2.2 Overtemperature Shutdown (OTS)

During an overtemperature shutdown:

- the corresponding output is disabled immediately after the deglitch time  $t_{\text{FAULT SD}}$
- the status is reported after  $t_{\text{FAULT SD}}$  in the quick status register #1 and the corresponding channel status register #2... #6.

To restart the output after an overtemperature shutdown event in Normal mode:

- the overtemperature condition must be removed, and the channel must be restarted by a write command of the ON bit in the corresponding channel control register #2... #6, or in the output control register #8

To delatch the diagnosis:

- the overtemperature condition must be removed:
- a read command of the corresponding channel status register #2... #6 must be performed

To restart the output after an overtemperature shutdown event in Fail mode:

- a mode transition is needed. Refer to [Mode Transitions](#) section

### 6.1.3.2.3 Electrical Characterization

**Table 10. Electrical Characteristics**

Characteristics noted under conditions  $7.0 \text{ V} \leq V_{\text{PWR}} \leq 18 \text{ V}$ ,  $-40 \text{ }^\circ\text{C} \leq T_{\text{A}} \leq 125 \text{ }^\circ\text{C}$ ,  $\text{GND} = 0 \text{ V}$ , unless otherwise noted. Typical values noted reflect the approximate parameter means at  $T_{\text{A}} = 25 \text{ }^\circ\text{C}$  under nominal conditions, unless otherwise noted.

Symbol	Characteristic	Min	Typ	Max	Unit	Notes
<b>POWER OUTPUTS OUT1... OUT5</b>						
$T_{\text{OW}}$	Overtemperature Warning <ul style="list-style-type: none"> <li>• <math>T_{\text{OW1}}</math> level</li> <li>• <math>T_{\text{OW2}}</math> level</li> </ul>	100 120	115 135	130 150	$^\circ\text{C}$	(19)
$T_{\text{OTS}}$	Overtemperature Shutdown	155	170	185	$^\circ\text{C}$	(19)
$t_{\text{FAULT SD}}$	Fault Deglitch Time <ul style="list-style-type: none"> <li>• OTS</li> </ul>	2.0	5.0	10	$\mu\text{s}$	

Notes

19. Guaranteed by testmode.

## 6.1.3.3 Undervoltage and Overvoltage Protections

### 6.1.3.3.1 Undervoltage

During an undervoltage condition ( $V_{PWRPOR} \leq V_{PWR} \leq V_{PWRUVF}$ ), all outputs (OUT1... OUT5) are switched off immediately after deglitch time  $t_{FAULTSD}$ .

The undervoltage condition is reported after the deglitch time  $t_{FAULTSD}$

- in the device status flag (DSF) in the registers #1... #7
- in the undervoltage flag (UVF) inside the device status register #7

Normal mode

The reactivation of the outputs is controlled by the microcontroller.

To restart, the output the undervoltage condition must be removed and:

- a write command of the ON Bit must be performed in the corresponding channel control register #2... #6 or in the output control register #8

To delatch the diagnosis

- the undervoltage condition must be removed
- a read command of the device status register #7 must be performed

Fail mode

When the device is in Fail mode, the restart of the outputs is controlled by the autorestart feature.

### 6.1.3.3.2 Overvoltage

The device is protected against overvoltage on  $V_{PWR}$ .

During:

- jump start condition, the device may be operated, but with respect to the device limits
- load dump condition ( $V_{PWRLDMAX} = 40\text{ V}$ ) the device does not conduct energy to the loads

The overvoltage condition ( $V_{PWR} \geq V_{PWR OVF}$ ) is reported in the

- device status flag (DSF) in the registers #1... #7
- overvoltage flag (OVF) inside the device status register #7

To delatch the diagnosis

- the overvoltage condition must be removed
- a read command of the device status register #7 must be performed

In case of an overvoltage ( $V_{PWR} \geq V_{PWRHIGH}$ ), the device is not "short-circuit" proof

### 6.1.3.3.3 Electrical Characterization

**Table 11. Electrical Characteristics**

Characteristics noted under conditions  $7.0\text{ V} \leq V_{PWR} \leq 18\text{ V}$ ,  $-40\text{ °C} \leq T_A \leq 125\text{ °C}$ ,  $GND = 0\text{ V}$ , unless otherwise noted. Typical values noted reflect the approximate parameter means at  $T_A = 25\text{ °C}$  under nominal conditions, unless otherwise noted.

Symbol	Characteristic	Min	Typ	Max	Unit	Notes
<b>SUPPLY VPWR</b>						
$V_{PWRUVF}$	Supply Undervoltage	5.0	5.25	5.5	V	
$V_{PWRUVFHYS}$	Supply Undervoltage Hysteresis	200	350	500	mV	
$V_{PWR OVF}$	Supply Overvoltage	28	30	32	V	
$V_{PWR OVFHYS}$	Supply Overvoltage Hysteresis	0.5	1.0	1.5	V	
$V_{PWR LD MAX}$	Supply Load Dump Voltage (2.0 min at 25 °C)	40	–	–	V	

**Table 11. Electrical Characteristics**

Characteristics noted under conditions  $7.0\text{ V} \leq V_{\text{PWR}} \leq 18\text{ V}$ ,  $-40\text{ }^\circ\text{C} \leq T_{\text{A}} \leq 125\text{ }^\circ\text{C}$ ,  $\text{GND} = 0\text{ V}$ , unless otherwise noted. Typical values noted reflect the approximate parameter means at  $T_{\text{A}} = 25\text{ }^\circ\text{C}$  under nominal conditions, unless otherwise noted.

Symbol	Characteristic	Min	Typ	Max	Unit	Notes
<b>SUPPLY VPWR (Continued)</b>						
$V_{\text{PWR HIGH}}$	Maximum Supply Voltage for Short-circuit Protection	32	–	–	V	
$t_{\text{FAULT SD}}$	Fault Deglitch Time • UV and OV	2.0	3.5	5.5	$\mu\text{s}$	

### 6.1.3.4 Charge Pump Protection

The charge pump voltage is monitored in order to protect the smart switches in case of:

- power up
- failure of external capacitor
- failure of charge pump circuitry

During power up, when the charge pump voltage has not yet settled to its nominal output voltage range, the outputs can not be turned on. Any turn on command during this phase is executed immediately after settling of the charge pump.

When the charge pump voltage is not within its nominal output voltage range:

- the power outputs are disabled immediately after the deglitch time  $t_{\text{FAULT SD}}$
- the failure status is reported after  $t_{\text{FAULT SD}}$  in the device status flag DSF in the registers #1... #7 and the CPF in the quick status register #1
- Any turn on command during this phase is executed including the OCHI windows immediately after the charge pump output voltage has reached its valid range

To delatch the diagnosis:

- the charge pump failure condition must be removed
- a read command of the quick status register #1 is necessary

#### 6.1.3.4.1 Electrical Characterization

**Table 12. Electrical Characteristics**

Characteristics noted under conditions  $7.0\text{ V} \leq V_{\text{PWR}} \leq 18\text{ V}$ ,  $-40\text{ }^\circ\text{C} \leq T_{\text{A}} \leq 125\text{ }^\circ\text{C}$ ,  $\text{GND} = 0\text{ V}$ , unless otherwise noted. Typical values noted reflect the approximate parameter means at  $T_{\text{A}} = 25\text{ }^\circ\text{C}$  under nominal conditions, unless otherwise noted.

Symbol	Characteristic	Min	Typ	Max	Unit	Notes
<b>CHARGE PUMP CP</b>						
$C_{\text{CP}}$	Charge Pump Capacitor Range (Ceramic type X7R)	47	–	220	nF	
$V_{\text{CP MAX}}$	Maximum Charge Pump Voltage	–	–	16	V	
$t_{\text{FAULT SD}}$	Fault Deglitch Time • CPF	–	4.0	6.0	$\mu\text{s}$	

### 6.1.3.5 Reverse Supply Protection

The device is protected against reverse polarity of the  $V_{\text{PWR}}$  line.

In reverse polarity condition:

- the output transistors OUT1... 5 are turned ON in order to prevent the device from thermal overload
- the OUT6 pin is pulled down to GND. An external current limit resistor shall be added in series with OUT6 pin
- no output protection is available in this condition

## 6.1.4 Output Clamps

### 6.1.4.1 Negative Output Clamp

In case of an inductive load (L), the energy is dissipated after the turn-off inside the N-channel MOSFET.

When  $t_{CL} (=I_o \times L / V_{CL}) > 1.0$  ms, the turn-off waveform can be simplified with a rectangle as shown in [Figure 21](#).

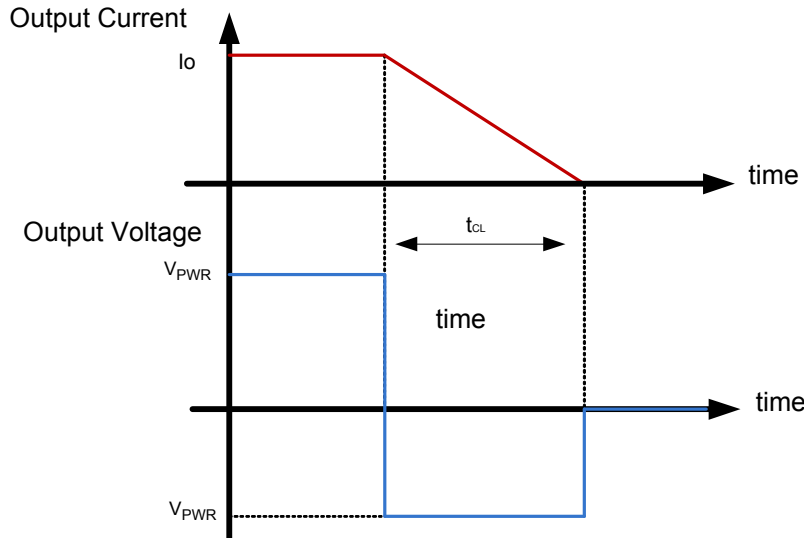

**Figure 21. Simplified Negative Output Clamp Waveform**

The energy dissipated in the N-Channel MOSFET is:  $E_{CL} = 1/2 \times L \times I_o^2 \times (1 + V_{PWR} / |V_{CL}|)$ .

In the case of  $t_{CL} < 1.0$  ms, please contact the factory for guidance.

### 6.1.4.2 Supply Clamp

The device is protected against dynamic overvoltage on the  $V_{PWR}$  line by means of an active gate clamp, which activates the output transistors in order to limit the supply voltage ( $V_{DCCLAMP}$ ).

In case of an overload on an output the corresponding switch is turned off, which leads to high voltage at  $V_{PWR}$  with an inductive  $V_{PWR}$  line. The maximum  $V_{PWR}$  voltage is limited at  $V_{DCCLAMP}$  by active clamp circuitry through the load.

In case of an OpenLoad condition, the positive transient pulses (acc. automotive specification ISO 7637 / pulse 2 and inductive supply line) shall be handled by the application. In case of negative transients on the  $V_{PWR}$  line (acc. ISO7637-2 / pulse 1), the energy of the pulses are dissipated inside the load, or shall be drained by an external clamping circuit, during a high ohmic load.

### 6.1.4.3 Electrical Characterization

**Table 13. Electrical Characteristics**

Characteristics noted under conditions  $7.0 \text{ V} \leq V_{PWR} \leq 18 \text{ V}$ ,  $-40 \text{ }^\circ\text{C} \leq T_A \leq 125 \text{ }^\circ\text{C}$ ,  $\text{GND} = 0 \text{ V}$ , unless otherwise noted. Typical values noted reflect the approximate parameter means at  $T_A = 25 \text{ }^\circ\text{C}$  under nominal conditions, unless otherwise noted.

Symbol	Characteristic	Min	Typ	Max	Unit	Notes
<b>SUPPLY VPWR</b>						
$V_{DCCLAMP}$	Supply Clamp Voltage	41	–	50	V	
<b>POWER OUTPUTS OUT1... OUT5</b>						
$V_{CL}$	Negative Power Channel Clamp Voltage				V	
	• 7.0 m $\Omega$	-20.5	–	-17.5		
	• 17 m $\Omega$	-21	–	-18		



## 6.1.5 Digital Diagnostics

The device offers several modes for load status detection in on state and off state through SPI.

### 6.1.5.1 OpenLoad Detections

#### 6.1.5.1.1 OpenLoad in ON State

OpenLoad detection during ON state is provided for each power output (OUT1... OUT5), based on the current monitoring circuit. The detection is activated automatically when the output is in on state.

The detection threshold is dependent on:

- the OLLED EN bits inside the OLLED control register #13-2

The detection result is reported in:

- the corresponding QSFx bit in the quick status register #1
- the global open load flag OLF (registers #1... #7)
- the OLON bit of the corresponding channel status registers #2... #6

To delatch the diagnosis:

- the openload condition must be removed
- a read command of the corresponding channel status register #2... #6 must be performed

When an open load has been detected, the output remains in on state.

The deglitch time of the OpenLoad in on state can be controlled individually for each output in order to be compliant with different load types.

The setting is dependent on the OLON DGL bits inside the OpenLoad control register #13-1:

- low (logic[0]) the deglitch time is  $t_{OLON\ DGL} = 64\ \mu s$  typ (bulb mode)
- high (logic[1]) the deglitch time is  $t_{OLON\ DGL} = 2.0\ ms$  typ (converter mode)

The deglitching filter is reset whenever output falls low and is only active when the output is high.

#### 6.1.5.1.2 OpenLoad in ON State for LED

For detection of small load currents (e.g. LED) in on state of the switch a special low current detection mode is implemented by using the OLLED EN bit.

The detection principle is based on a digital decision during regular switch off of the output.

Thereby a current source ( $I_{OLLED}$ ) is switched on and the falling edge of the output voltage is evaluated by a comparator at  $V_{PWR} - 0.75\ V$  (typ).

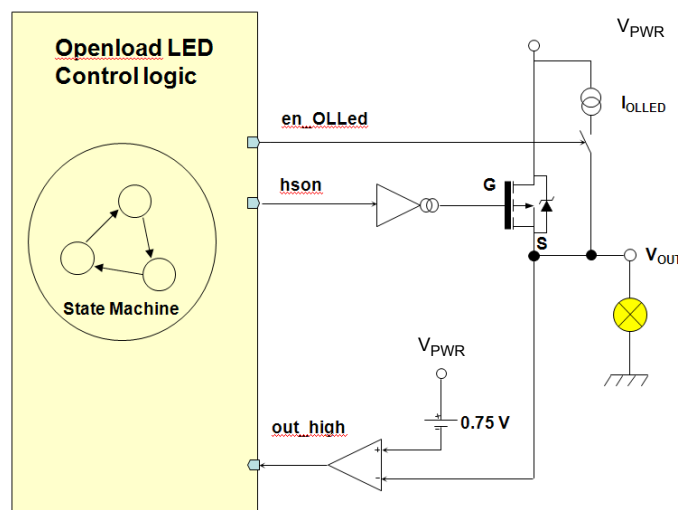

Figure 22. OpenLoad in ON State Diagram for LED

The OLLED fault is reported when the output voltage is above  $V_{PWR} - 0.75$  V after 2.0 ms off-time or at each turn-on command in case of off-time < 2.0 ms.

The detection mode is enabled individually for each channel with the OLLED EN bits inside the LED control register #13-2.

When the corresponding OLLED EN bit is:

- low (logic[0]), the standard OpenLoad in on state (OLON) is enabled
- high (logic[1]), the OLLED detection is enabled

The detection result is reported in:

- the corresponding QSFx bit in the quick status register #1
- the global open load flag OLF (register #1... #7)
- the OLON bit of the corresponding channel status register #2... #6

When an OpenLoad has been detected, the output remains in on state.

When output is in PWM operation:

- the detection is performed at the end of the on time of each PWM cycle
- the detection is active during the off time of the PWM signal, up to 2.0 ms max.

The current source ( $I_{OLLED}$ ) is disabled after “no OLLED” detection or after 2.0 ms.

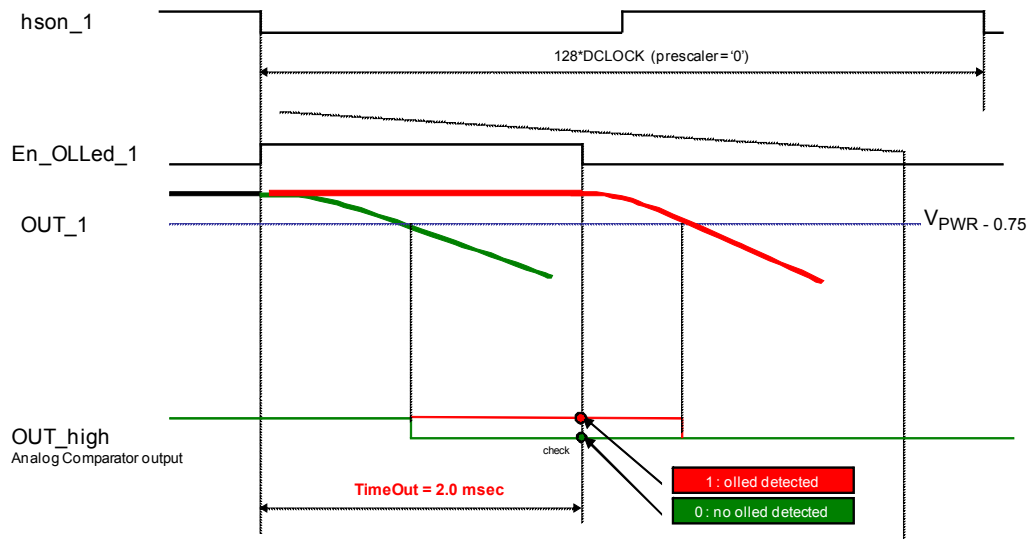

**Figure 23. OpenLoad in ON State for LED in PWM Operation (OFF time > 2.0 ms)**

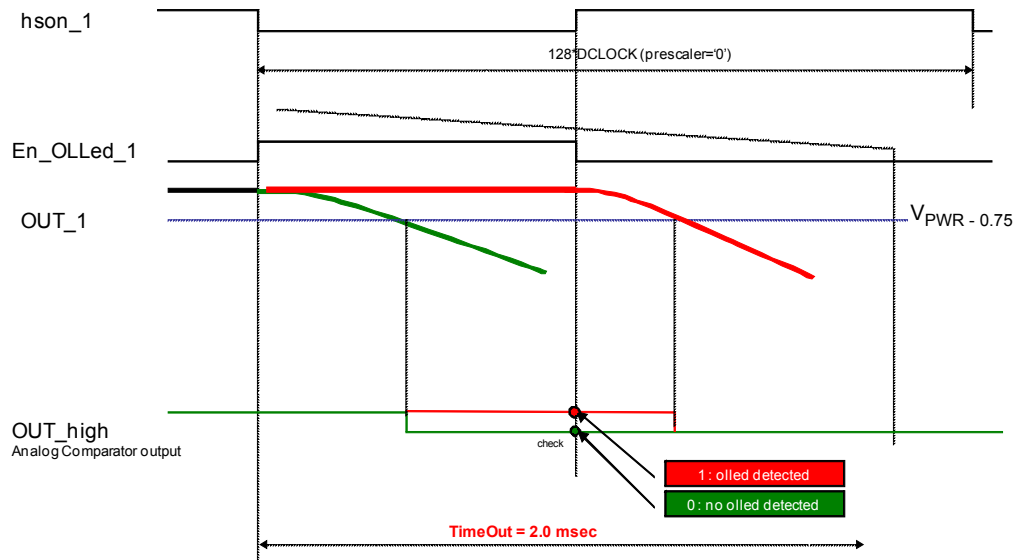

**Figure 24. Openload in ON State for LED in PWM Operation (OFF time < 2.0 ms)**

When output is in fully ON operation (100% PWM):

- the detection on all outputs is triggered by setting the OLLED TRIG bit inside the LED control register #13-2
- at the end of detection time, the current source ( $I_{OLLED}$ ) is disabled 100  $\mu$ sec (typ.) after the output reactivation

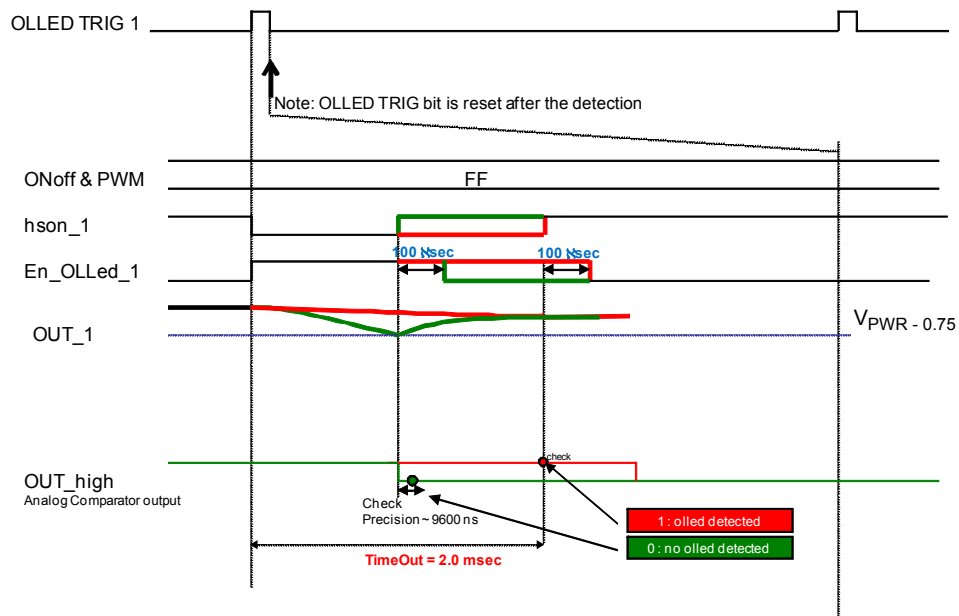

**Figure 25. Openload in ON State for LED in Fully ON Operation**

The OLLED TRIG bit is reset after the detection.

To delatch the diagnosis:

- a read command of the corresponding channel status register #2... #6 must be performed

A false "open" result could be reported in the OLON bit:

- for high duty cycles, the PWM off-time becomes too short
- for capacitive load, the output voltage slope becomes too slow

### 6.1.5.1.3 OpenLoad in OFF State

An OpenLoad in off state detection is provided individually for each power output (OUT1... OUT5).

The detection is enabled individually for each channel by the OLOFF EN bits inside the open load control register #13-1.

When the corresponding OLOFF EN is:

- low (logic[0]), the diagnosis mode is disabled (default status)
- high (logic[1]), the diagnosis mode is started for  $t_{OLOFF}$ . It is not possible to restart any OLOFF or disable the diagnosis mode during active OLOFF state

This detection can be activated independently for each power output (OUT1... OUT5). When it is activated, it is always activated synchronously for all selected outputs (with positive edge of CS\).

When the detection is started, the corresponding output channel is turned on with a fixed overcurrent threshold of  $I_{OLOFF}$  threshold.

When this overcurrent threshold is:

- reached within the detection timeout  $t_{OLOFF}$ , the output is turned off and the OLOFF EN bit is reset. No OCLOx and no OLOFFx will be reported.
- not reached within the detection timeout  $t_{OLOFF}$ , the output is turned off after  $t_{OLOFF}$  and the OLOFF EN bit is reset. The OLOFFx will be reported.

The overcurrent behavior as commanded by the overcurrent control settings (NO OCHIx, OCHI ODx, SHORTOCHIx, OCLOx, and ACM ENx) is not be affected by applying the OLOFF ENx bit. The same is true for the output current feedback and the current sense synchronization.

The detection result is reported in:

- the corresponding QSFx bit in the quick status register #1
- the global open load flag OLF (register #1... #7)
- the OLOFF bit of the corresponding channel status register #2... #6

To delatch the diagnosis, a read command of the corresponding channel status register #2... #6 must be performed.

In case any fault during  $t_{OLOFF}$  (OTS, UV, CPF,), the OpenLoad in off state detection is disabled and the output(s) is (are) turned off after the deglitch time  $t_{FAULT SD}$ . The corresponding fault is reported in the SPI SO registers.

### 6.1.5.1.4 Electrical Characterization

**Table 14. Electrical Characteristics**

Characteristics noted under conditions  $7.0\text{ V} \leq V_{PWR} \leq 18\text{ V}$ ,  $-40\text{ }^\circ\text{C} \leq T_A \leq 125\text{ }^\circ\text{C}$ ,  $\text{GND} = 0\text{ V}$ , unless otherwise noted. Typical values noted reflect the approximate parameter means at  $T_A = 25\text{ }^\circ\text{C}$  under nominal conditions, unless otherwise noted.

Symbol	Characteristic	Min	Typ	Max	Unit	Notes
<b>POWER OUTPUTS OUT1... OUT5</b>						
$I_{OL}$	Openload Current Threshold in ON State <ul style="list-style-type: none"> <li>• 7.0 mΩ Power Channel at <math>T_J = -40\text{ }^\circ\text{C}</math></li> <li>• 7.0 mΩ Power Channel at <math>T_J = 25\text{ }^\circ\text{C}</math> and <math>125\text{ }^\circ\text{C}</math></li> <li>• 17 mΩ Power Channel at <math>T_J = -40\text{ }^\circ\text{C}</math></li> <li>• 17 mΩ Power Channel at <math>T_J = 25\text{ }^\circ\text{C}</math> and <math>125\text{ }^\circ\text{C}</math></li> </ul>	50 100 30 50	200 200 100 100	350 300 160 150	mA	
$\delta_{PWM OLON}$	Output PWM Duty Cycle Range for Openload Detection in ON state <ul style="list-style-type: none"> <li>• Low Frequency Range (25 to 100 Hz)</li> <li>• Medium Frequency Range (100 to 200 Hz)</li> <li>• High Frequency Range (200 to 400 Hz)</li> </ul>	18 18 17	– – –	– – –	LSB	
$I_{OLLED}$	Openload Current Threshold in ON state / OLLED mode	2.0	4.0	5.0	mA	
$t_{OLLED100}$	Maximum Openload Detection Time / OLLED mode with 100% duty cycle	1.5	2.0	2.6	ms	
$t_{OLOFF}$	Openload Detection Time in OFF State	0.9	1.2	1.5	ms	

**Table 14. Electrical Characteristics**

Characteristics noted under conditions  $7.0\text{ V} \leq V_{PWR} \leq 18\text{ V}$ ,  $-40\text{ }^\circ\text{C} \leq T_A \leq 125\text{ }^\circ\text{C}$ ,  $\text{GND} = 0\text{ V}$ , unless otherwise noted. Typical values noted reflect the approximate parameter means at  $T_A = 25\text{ }^\circ\text{C}$  under nominal conditions, unless otherwise noted.

Symbol	Characteristic	Min	Typ	Max	Unit	Notes
<b>POWER OUTPUTS OUT1... OUT5 (Continued)</b>						
$t_{\text{FAULT SD}}$	Fault Deglitch Time					
	• OLOFF	2.0	3.3	5.0	$\mu\text{s}$	
	• OLON with OLON DGL = 0	48	64	80	ms	
	• OLON with OLON DGL = 1	1.5	2.0	2.5	ms	
$I_{\text{OLOFF}}$	Openload Current Threshold in OFF state	0.385	0.55	0.715	A	

### 6.1.5.2 Output Shorted to VPWR in OFF State

A short to  $V_{PWR}$  detection during OFF state is provided individually for each power output OUT1... OUT5, based on an output voltage comparator referenced to  $V_{PWR} / 2$  ( $V_{\text{OUT DETECT}}$ ) and an external pull-down circuitry.

The detection result is reported in the OUTx bits of the I/O status register #8 in real time.

In case of UVF, the OUTx bits are undefined.

#### 6.1.5.2.1 Electrical Characterization

**Table 15. Electrical Characteristics**

Characteristics noted under conditions  $7.0\text{ V} \leq V_{PWR} \leq 18\text{ V}$ ,  $-40\text{ }^\circ\text{C} \leq T_A \leq 125\text{ }^\circ\text{C}$ ,  $\text{GND} = 0\text{ V}$ , unless otherwise noted. Typical values noted reflect the approximate parameter means at  $T_A = 25\text{ }^\circ\text{C}$  under nominal conditions, unless otherwise noted.

Symbol	Characteristic	Min	Typ	Max	Unit	Notes
<b>POWER OUTPUTS OUT1... OUT5</b>						
$V_{\text{OUT detect}}$	Output Voltage Comparator Threshold	0.42	0.5	0.58	$V_{PWR}$	

### 6.1.5.3 SPI Fault Reporting

Protection and monitoring of the outputs during normal mode is provided by digital switch diagnosis via the SPI.

The selection of the SO data word is controlled by the SOA0... SOA3 bits inside the initialization 1 register #0.

The device provides two different reading modes, depending on the SOA MODE bit.

When the SOA MODE bit is:

- low (logic[0]), the programmed SO address will be used for a single read command. After the reading the SO address returns to quick status register #1 (default state)
- high (logic[1]), the programmed SO address will be used for the next and all further read commands until a new programming

The “quick status register” #1 provides one glance failure overview. As long as no failure flag is set (logic[1]), no control action by the microcontroller is necessary.

Register	SO address					SO data											
	#	D15	D14	D13	D12	D11	D10	D9	D8	D7	D6	D5	D4	D3	D2	D1	D0
quick status	1	0	0	0	1	FM	DSF	OVLf	OLf	CPF	RCF	CLKF	QSF5	QSF4	QSF3	QSF2	QSF1

- FM: Fail mode indication. This bit is also present in all other SO data words, and indicates the fail mode by a logic[1]. When the device is in Normal mode, the bit is logic[0]
- global device status flags (D10... D8): These flags are also present in the channel status registers #2... #6, the device status register #7, and are cleared when all fault bits are cleared by reading the registers #2... #7

- DSF = device status flag (RCF, or UVF, or OVF, or CPF, or CLKF, or TMF). UVF and TMF are also reported in the device status register #7
- OVLF = over load flag (wired OR of all OC and OTS signals)
- OLF = openload flag
- CPF: charge pump flag
- RCF: registers clear flag: this flag is set (logic[1]) when all SI and SO registers are reset
- CLKF: clock fail flag. Refer to [Logic I/O Plausibility Check](#) section
- QSF1... QSF5: channel quick status flags (QSFx = OC0x, or OC1x, or OC2x, or OTWx, or OTSx, or OLONx, or OLOFFx)

The SOA address #0 is also mapped to register #1 (D15... D12 bits will report logic [0001]).

When a fault condition is indicated by one of the quick status bits (QSF1... QSF5, OVLF, OLF), the detailed status can be evaluated by reading of the corresponding channel status registers #2... #6.

Register	SO address					SO data											
	#	D15	D14	D13	D12	D11	D10	D9	D8	D7	D6	D5	D4	D3	D2	D1	D0
CH 1 status	2	0	0	1	0	FM	DSF	OVLF	OLF	res	OTS1	OTW1	OC21	OC11	OC01	OLON1	OLOFF1
CH 2 status	3	0	0	1	1	FM	DSF	OVLF	OLF	res	OTS2	OTW2	OC22	OC12	OC02	OLON2	OLOFF2
CH 3 status	4	0	1	0	0	FM	DSF	OVLF	OLF	res	OTS3	OTW3	OC23	OC13	OC03	OLON3	OLOFF3
CH 4 status	5	0	1	0	1	FM	DSF	OVLF	OLF	res	OTS4	OTW4	OC24	OC14	OC04	OLON4	OLOFF4
CH 5 status	6	0	1	1	0	FM	DSF	OVLF	OLF	res	OTS5	OTW5	OC25	OC15	OC05	OLON5	OLOFF5

- OTSx: overtemperature shutdown flag
- OTWx: overtemperature warning flag
- OC0x... OC2x: overcurrent status flags
- OLONx: OpenLoad in on state flag
- OLOFFx: OpenLoad in off state flag

The most recent OC fault is reported by the OC0x... OC2x bits, if a new OC occurs before an old OC on the same output that was read.

When a fault condition is indicated by one of the global status bits (FM, DSF), the detailed status can be evaluated by reading of the device status registers #7:

Register	SO address					SO data											
	#	D15	D14	D13	D12	D11	D10	D9	D8	D7	D6	D5	D4	D3	D2	D1	D0
device status	7	0	1	1	1	FM	DSF	OVLF	OLF	res	res	res	TMF	OVF	UVF	SPIF	iLIMP

- TMF: testmode activation flag. Testmode is used for manufacturing testing only. If this bit is set to logic [1], the MCU shall reset the device.
- OVF: overvoltage flag
- UVF: undervoltage flag
- SPIF: SPI fail flag
- iLIMP (real time reporting after the  $t_{IN\_DGL}$ , not latched)

The I/O status register #8 can be used for system test, fail mode test and the power down procedure:

Register	SO address					SO data											
	#	D15	D14	D13	D12	D11	D10	D9	D8	D7	D6	D5	D4	D3	D2	D1	D0
I/O status	8	1	0	0	0	FM	res	TOGGLE	iIN4	iIN3	iIN2	iIN1	OUT5	OUT4	OUT3	OUT2	OUT1

The register provides the status of the control inputs, the toggle signal, and the power outputs state in real time (not latched).

- TOGGLE = status of the 4 input toggle signals (IN1\_ON, or IN2\_ON, or IN3\_ON, or IN4\_ON), reported in real time
- iINx = status of iINx signal (real time reporting after the  $t_{IN\_DGL}$ , not latched)
- OUTx = status of output pins OUTx (the detection threshold is  $V_{PWR}/2$ ) when undervoltage condition does not occur

The device can be clearly identified by the device ID register #9 when the supply voltage is within its nominal range:

Register	SO address					SO data												
	#	D15	D14	D13	D12	D11	D10	D9	D8	D7	D6	D5	D4	D3	D2	D1	D0	
device ID	9	1	0	0	1	X	X	X	X	DEVID <sub>7</sub>	DEVID <sub>6</sub>	DEVID <sub>5</sub>	DEVID <sub>4</sub>	DEVID <sub>3</sub>	DEVID <sub>2</sub>	DEVID <sub>1</sub>	DEVID <sub>0</sub>	

#2-#6	OC2x	OC1x	OC0x	over current status
	0	0	0	no overcurrent
	0	0	1	OCHI1
	0	1	0	OCHI2
	0	1	1	OCHI3
	1	0	0	OCLO
	1	0	1	OCHIOD
	1	1	0	SSC
	1	1	1	not used

The register delivers DEVIDx bits = 40hex for the 07XSF517.

During undervoltage condition (UVF = 1), DEVIDx bits report 00hex.

## 6.1.6 Analog Diagnostics

The analog feedback circuit (CSNS) is implemented to provide load and device diagnostics during Normal mode. During Fail and Sleep modes, the analog feedback is not available.

The routing of the integrated multiplexer is controlled by MUX0... MUX2 bits inside the initialization 1 register #0.

### 6.1.6.1 Output Current Monitoring

The current sense monitor provides a current proportional to the current of the selected output (OUT1... OUT5). CSNS output delivers 1.0 mA full scale range current source reporting channel 1... 5 current feedback ( $I_{FSR}$ ).

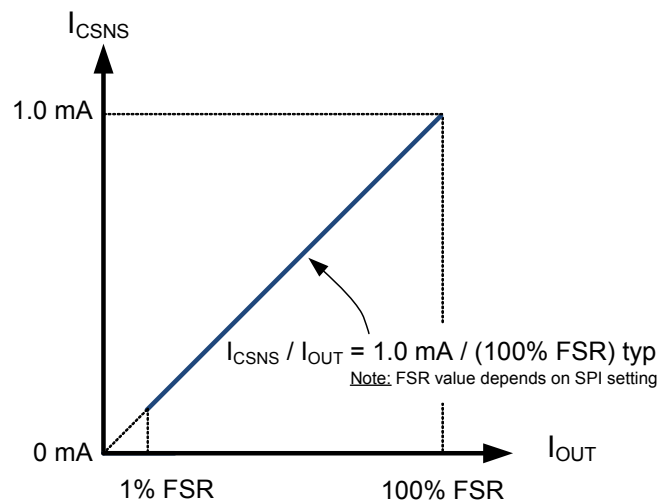

Figure 26. Output Current Sensing

The feedback is suppressed during OCHI window ( $t \leq t_{\text{OCHI1}} + t_{\text{OCHI2}} + t_{\text{OCHI3}}$ ) and only enabled during low overcurrent shutdown threshold (OCLO).

During PWM operation, the current feedback circuit (CSNS) delivers current only during the on time of the output switch.

Current sense settling time,  $t_{\text{CSNS(SET)}}$ , varies with current amplitude. Current sense valid time,  $t_{\text{CSNS(VAL)}}$ , depends on the PWM frequency (see [Electrical Characterization](#)).

An advanced current sense mode (ACM) is implemented in order to diagnose LED loads in Normal mode and to improve current sense accuracy for low current loads.

In the ACM mode, the offset sign of current sense amplifier is toggled on every CSNS SYNCB rising edge.

The error amplifier offset contribution to the CSNS error can be fully eliminated from the measurement result by averaging each two sequential current sense measurements.

The ACM mode is enabled with the ACM ENx bits inside the ACM control register #10-1.

When the ACM ENx bit is:

- low (logic[0]), ACM disabled (default status and during Fail mode)
- high (logic[1]), ACM enabled

In ACM mode:

- the precision of the current recopy feature (CSNS) is improved especially at low output current by averaging CSNS reporting on sequential PWM periods
- the current sense full scale range (FSR) is reduced by a factor of two
- the overcurrent protection threshold OCLO is reduced by a factor of two

[Figure 27](#) describes the timings between the selected channel current and the analog feedback current. Current sense validation time pertains to stabilization time needed after turn on. Current sense settling time pertains to the stabilization time needed after the load current changes while the output is continuously on or when another output signal is selected.

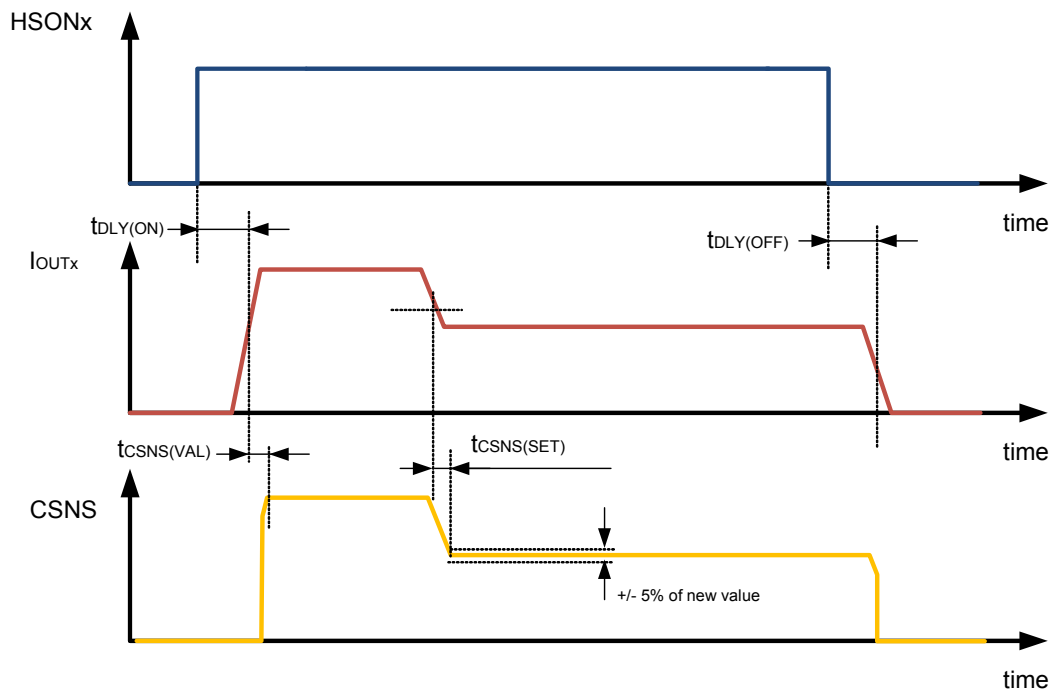

**Figure 27. Current Sensing Response Time**

Internal circuitry limits the voltage of the CSNS pin when its sense resistor is absent. This feature prevents damage to other circuitry sharing that electrical node, such as a microcontroller pin, for example.

Several 07XSF517 may be connected to one shared CSNS resistor.



### 6.1.6.2 Supply Voltage Monitoring

The  $V_{PWR}$  monitor provides a voltage proportional to the supply tab. The CSNS voltage is proportional to the  $V_{PWR}$  voltage as shown in [Figure 28](#).

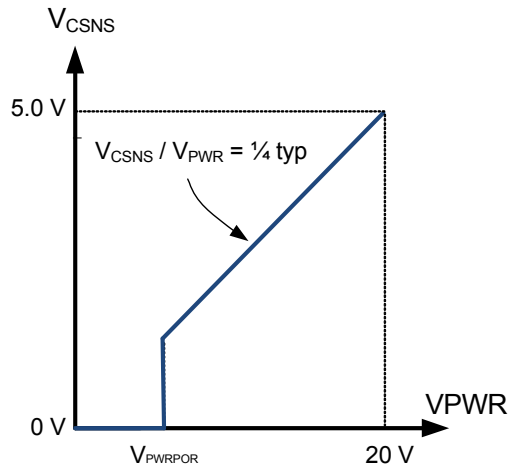

Figure 28. Supply Voltage Reporting

### 6.1.6.3 Temperature Monitoring

The average temperature of the control die is monitored by an analog temperature sensor. The CSNS pin can report the voltage of this sensor.

The chip temperature monitor output voltage is independent of the resistor connected to the CSNS pin, provided the resistor is within the min/max range of 5.0 k $\Omega$  to 50 k $\Omega$ . Temperature feedback range,  $T_{FB}$ , -40 °C to 150 °C.

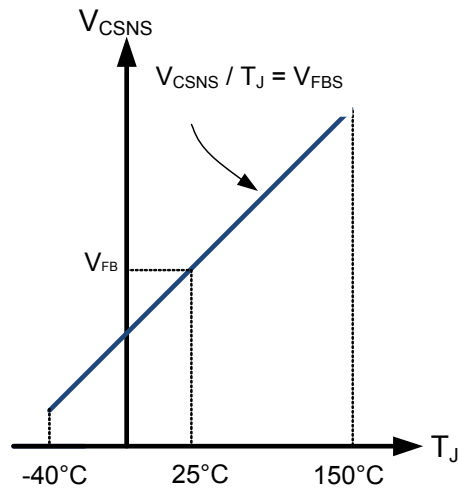

Figure 29. Temperature Reporting

### 6.1.6.4 Analog Diagnostic Synchronization

A current sense synchronization pin is provided to simplify the synchronous sampling of the CSNS signal.

The CSNS SYNCB pin is an open drain requiring an external 5.0 kΩ (min) pull-up resistor to  $V_{CC}$ .

The CSNS SYNC signal is

- available during Normal mode only
- behavior depends on the type of signal selected by the MUX2 ... MUX0 bits in the initialization 1 register #0. This signal is either a current proportional to an output current or a voltage proportional to temperature or the supply voltage

Current sense signal

When a current sense signal is selected:

- the pin delivers a recopy of the output control signal during on phase of the PWM defined by the SYNC EN0, SYNC EN1 bits inside the initialization 1 register #0

SYNC EN1	SYNC EN0	Setting	Behavior
0	0	OFF	CSNS SYNC is inactive (high).
0	1	VALID	CSNS SYNC is active (low) when CSNS is valid. During switching the output or MUX the CSNS SYNC is inactive (high).
1	0	TRIG0	As in setting VALID but after a change of the MUX the CSNS SYNC is inactive (high) until the next PWM cycle is started.
1	1	TRIG1/2	Pulses (active low) from the middle of the CSNS pulse to its end are generated. Switching phases (output and MUX) and the time from the MUX switching to the next middle of the CSNS pulse are blanked (high).

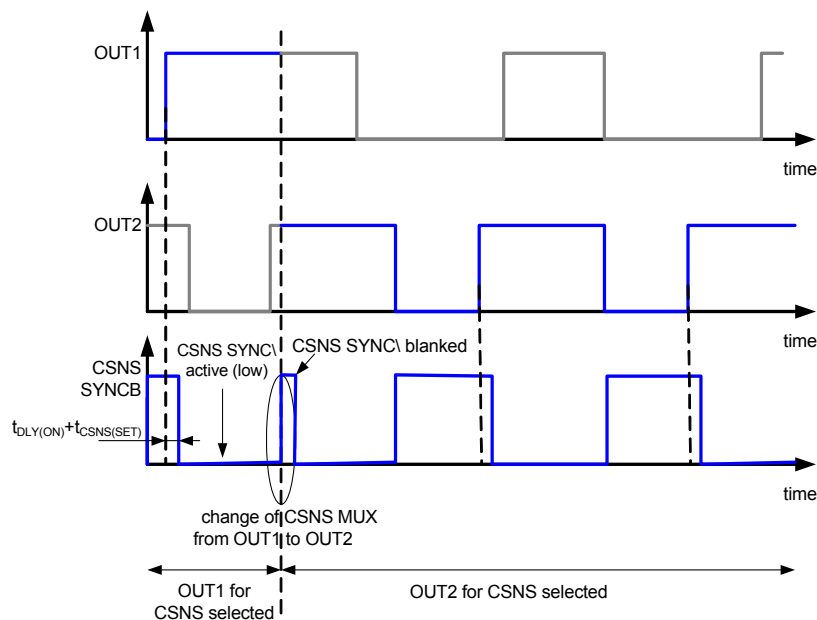
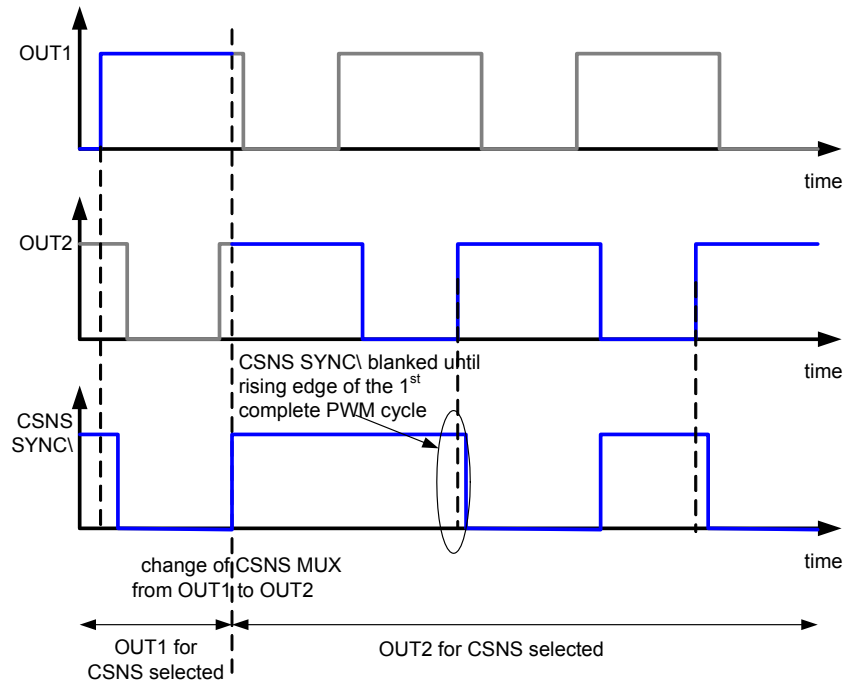
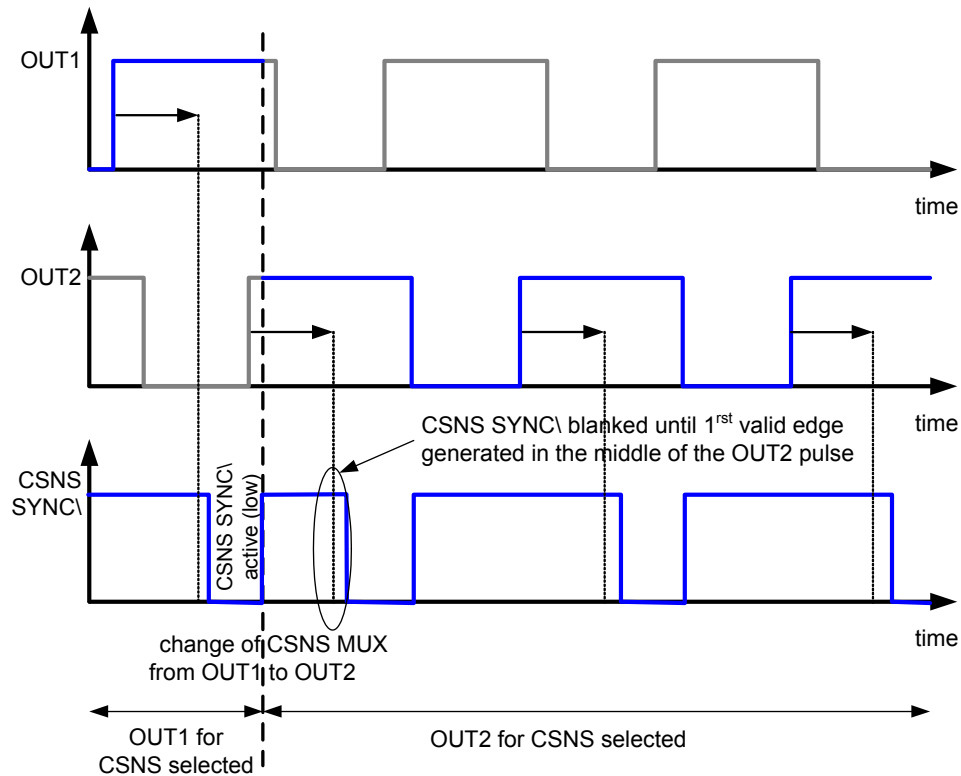

Figure 30. CSNS SYNC\ Valid Setting



**Figure 31. CSNS SYNC\ TRIG0 Setting**



**Figure 32. CSNS SYNC\ TRIG1/2 Setting**

- the CSNS SYNC\ pulse is suppressed during OCHI and during OFF phase of the PWM
- the CSNS SYNC\ is blanked during settling time of the CSNS multiplexer and ACM switching by a fixed time of  $t_{dly(on)} + t_{CSNS(SET)}$

- when a PWM clock fail is detected, the CSNS SYNCB delivers a signal with 50% duty cycle at a fixed period of 6.5 ms.
- when the output is programmed with 100% PWM, the CSNS SYNCB delivers a logic[0] a high pulse with the length of 100  $\mu$ s (typ.) during the PWM counter overflow for TRIG0 and TRIG1/2 settings, as shown in [Figure 33](#).

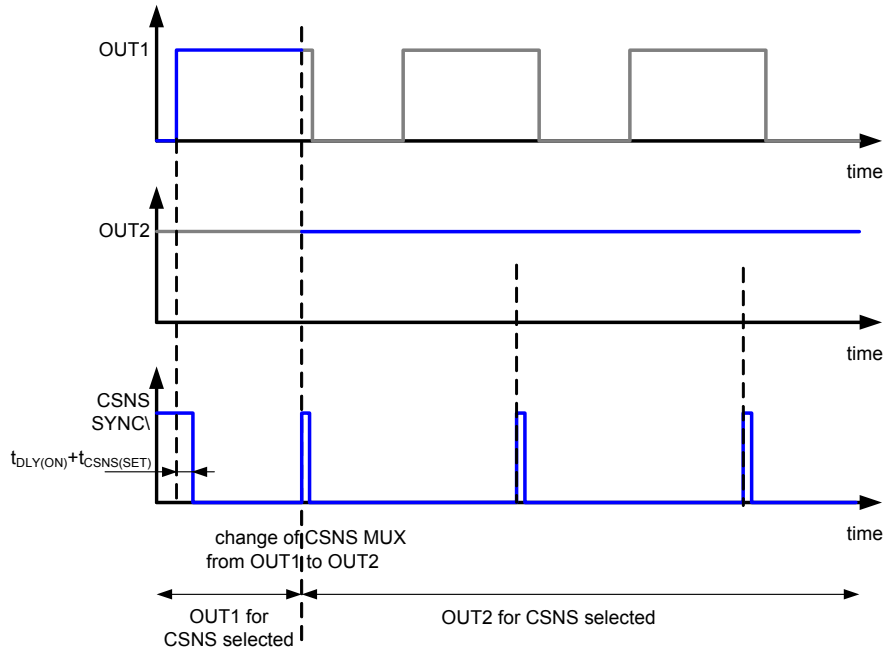

**Figure 33. CSNS SYNCB when the output is programmed with 100%**

- In case of output fault, the CSNS SYNCB signal for current sensing does not deliver a trigger signal until the output is enabled again.

Temperature signal or  $V_{PWR}$  monitor signal

When a voltage signal (average control die temperature or supply voltage) is selected:

- the CSNS SYNCB delivers a signal with 50% duty cycle and the period of the lowest prescaler setting ( $f_{CLK} / 1024$ ).
- and a PWM clock fail is detected, the CSNS SYNCB delivers a signal with 50% duty cycle at a fixed period of 6.5 ms ( $t_{SYNC\ DEFAULT}$ ).

## 6.1.6.5 Electrical Characterization

**Table 16. Electrical Characteristics**

Characteristics noted under conditions  $7.0\text{ V} \leq V_{PWR} \leq 18\text{ V}$ ,  $-40\text{ }^\circ\text{C} \leq T_A \leq 125\text{ }^\circ\text{C}$ ,  $\text{GND} = 0\text{ V}$ , unless otherwise noted. Typical values noted reflect the approximate parameter means at  $T_A = 25\text{ }^\circ\text{C}$  under nominal conditions, unless otherwise noted.

Symbol	Characteristic	Min	Typ	Max	Unit	Notes
<b>CURRENT SENSE CSNS</b>						
$R_{CSNS}$	Current Sense Resistor Range	5.0	–	50	$\text{k}\Omega$	
$I_{CSNS\ LEAK}$	Current Sense Leakage Current when CSNS is disabled	-1.0	–	+1.0	$\mu\text{A}$	
$V_{CS}$	Current Sense Clamp Voltage	6.0	–	8.0	V	

**Table 16. Electrical Characteristics**

Characteristics noted under conditions  $7.0\text{ V} \leq V_{PWR} \leq 18\text{ V}$ ,  $-40\text{ }^\circ\text{C} \leq T_A \leq 125\text{ }^\circ\text{C}$ ,  $\text{GND} = 0\text{ V}$ , unless otherwise noted. Typical values noted reflect the approximate parameter means at  $T_A = 25\text{ }^\circ\text{C}$  under nominal conditions, unless otherwise noted.

Symbol	Characteristic	Min	Typ	Max	Unit	Notes
<b>CURRENT SENSE CSNS (Continued)</b>						
$I_{FSR}$	Current Sense Full Scale Range for 7.0 mΩ Power Channel <ul style="list-style-type: none"> <li>High OCLO and ACM = 0</li> <li>Low OCLO and ACM = 0</li> <li>High OCLO and ACM = 1</li> <li>Low OCLO and ACM = 1</li> </ul>	–	22	–	A	
ACC $I_{CSNS}$	Current Sense Accuracy for $9.0\text{ V} \leq V_{PWR} \leq 18\text{ V}$ for 7.0 mΩ Power Channel <ul style="list-style-type: none"> <li><math>I_{OUT} = 80\%</math> FSR with ACM = 0</li> <li><math>I_{OUT} = 25\%</math> FSR with ACM = 0</li> <li><math>I_{OUT} = 10\%</math> FSR with ACM = 0</li> <li><math>I_{OUT} = 5.0\%</math> FSR with ACM = 0</li> <li><math>I_{OUT} = 80\%</math> FSR with High OCLO and ACM = 1</li> <li><math>I_{OUT} = 25\%</math> FSR with High OCLO and ACM = 1</li> <li><math>I_{OUT} = 10\%</math> FSR with High OCLO and ACM = 1</li> <li><math>I_{OUT} = 5.0\%</math> FSR with High OCLO and ACM = 1</li> <li><math>I_{OUT} = 80\%</math> FSR with Low OCLO and ACM = 1</li> <li><math>I_{OUT} = 25\%</math> FSR with Low OCLO and ACM = 1</li> <li><math>I_{OUT} = 10\%</math> FSR with Low OCLO and ACM = 1</li> <li><math>I_{OUT} = 5.0\%</math> FSR with Low OCLO and ACM = 1</li> </ul>	–11	–	+11	%	
		–14	–	+14		
		–20	–	+20		
		–29	–	+29		
		–14	–	+14		
		–18	–	+18		
		–25	–	+25		
		–40	–	+40		
		–16	–	+16		
		–22	–	+22		
		–40	–	+40		
		–60	–	+60		
ACC $I_{CSNS1}$ CAL	Current Sense Accuracy for $9.0\text{ V} \leq V_{PWR} \leq 18\text{ V}$ with 1 calibration point at $25\text{ }^\circ\text{C}$ for 50% FSR and $V_{PWR} = 14\text{ V}$ for 7.0 mΩ Power Channel <ul style="list-style-type: none"> <li><math>I_{OUT} = 80\%</math> FSR</li> <li><math>I_{OUT} = 25\%</math> FSR</li> <li><math>I_{OUT} = 10\%</math> FSR</li> <li><math>I_{OUT} = 5.0\%</math> FSR</li> </ul>	–7.0	–	+7.0	%	(24) (22)
ACC $I_{CSNS2}$ CAL	Current Sense Accuracy for $9.0\text{ V} \leq V_{PWR} \leq 18\text{ V}$ with 2 calibration points at $25\text{ }^\circ\text{C}$ for 2.0% and 50% FSR and $V_{PWR} = 14\text{ V}$ for 7.0 mΩ Power Channel <ul style="list-style-type: none"> <li><math>I_{OUT} = 80\%</math> FSR</li> <li><math>I_{OUT} = 25\%</math> FSR</li> <li><math>I_{OUT} = 10\%</math> FSR</li> <li><math>I_{OUT} = 5.0\%</math> FSR</li> </ul>	–6.0	–	+6.0	%	(24) (22)
		–6.0	–	+6.0		
		–8.0	–	+8.0		
		–21	–	+21		
$I_{CSNSMIN}$	Minimum Current Sense Reporting for 17 mΩ <ul style="list-style-type: none"> <li><math>9.0\text{ V} &lt; V_{PWR} &lt; 12\text{ V}</math></li> <li><math>9.0\text{ V} &lt; V_{PWR} &lt; 18\text{ V}</math></li> </ul>	–	–	2.0	%	
$I_{FSR}$	Current Sense Full Scale Range for 17 mΩ Power Channel <ul style="list-style-type: none"> <li>High OCLO and ACM = 0</li> <li>Low OCLO and ACM = 0</li> <li>High OCLO and ACM = 1</li> <li>Low OCLO and ACM = 1</li> </ul>	–	11	–	A	
		–	5.5	–		
		–	5.5	–		
		–	2.75	–		

**Table 16. Electrical Characteristics**

Characteristics noted under conditions  $7.0\text{ V} \leq V_{PWR} \leq 18\text{ V}$ ,  $-40\text{ }^\circ\text{C} \leq T_A \leq 125\text{ }^\circ\text{C}$ ,  $\text{GND} = 0\text{ V}$ , unless otherwise noted. Typical values noted reflect the approximate parameter means at  $T_A = 25\text{ }^\circ\text{C}$  under nominal conditions, unless otherwise noted.

Symbol	Characteristic	Min	Typ	Max	Unit	Notes
<b>CURRENT SENSE CSNS (Continued)</b>						
ACC I <sub>CSNS</sub>	Current Sense Accuracy for $9.0\text{ V} \leq V_{PWR} \leq 18\text{ V}$ for 17 mΩ Power Channel <ul style="list-style-type: none"> <li>I<sub>OUT</sub> = 80% FSR</li> <li>I<sub>OUT</sub> = 25% FSR</li> <li>I<sub>OUT</sub> = 10% FSR</li> <li>I<sub>OUT</sub> = 5.0% FSR</li> </ul>	-11 -14 -20 -29	– – – –	+11 +14 +20 +29	%	(20)
ACC I <sub>CSNS1</sub> CAL	Current Sense Accuracy for $9.0\text{ V} \leq V_{PWR} \leq 18\text{ V}$ with 1 calibration point at 25 °C for 50% FSR and $V_{PWR} = 14\text{ V}$ for 17 mΩ Power Channel <ul style="list-style-type: none"> <li>I<sub>OUT</sub> = 80% FSR</li> <li>I<sub>OUT</sub> = 25% FSR</li> <li>I<sub>OUT</sub> = 10% FSR</li> <li>I<sub>OUT</sub> = 5.0% FSR</li> </ul>	-7.0 -7.0 -20 -29	– – – –	+7.0 +7.0 +20 +29	%	(20) (22)
ACC I <sub>CSNS2</sub> CAL	Current Sense Accuracy for $9.0\text{ V} \leq V_{PWR} \leq 18\text{ V}$ with 2 calibration points at 25 °C for 2.0% and 50% FSR and $V_{PWR} = 14\text{ V}$ for 17 mΩ Power Channel <ul style="list-style-type: none"> <li>I<sub>OUT</sub> = 80% FSR</li> <li>I<sub>OUT</sub> = 25% FSR</li> <li>I<sub>OUT</sub> = 10% FSR</li> <li>I<sub>OUT</sub> = 5.0% FSR</li> </ul>	-6.0 -6.0 -8.0 -11	– – – –	+6.0 +6.0 +8.0 +11	%	(20) (22)
I <sub>CSNSMIN</sub>	Minimum Current Sense Reporting for 17 mΩ <ul style="list-style-type: none"> <li>for <math>9.0\text{ V} \leq V_{PWR} \leq 18\text{ V}</math>, max. = 1%</li> </ul>	–	–	1.0	%	(20) (23)
V <sub>PWR</sub>	Supply Voltage Feedback Range	V <sub>PWRMAX</sub>	–	20	V	
ACC V <sub>PWR</sub>	Supply Feedback Precision <ul style="list-style-type: none"> <li>Default</li> <li>1 calibration point at 25 °C and <math>V_{PWR} = 12\text{ V}</math>, for <math>7.0\text{ V} \leq V_{PWR} \leq 20\text{ V}</math></li> <li>1 calibration point at 25 °C and <math>V_{PWR} = 12\text{ V}</math>, for <math>6.0\text{ V} \leq V_{PWR} &lt; 7.0\text{ V}</math></li> </ul>	-5.0 -1.0 -2.2	– – –	+5.0 +1.0 +2.2	%	(22)
T <sub>FB</sub>	Temperature Feedback Range	-40	–	150	°C	(21)
V <sub>FB</sub>	Temperature Feedback Voltage at 25 °C	–	2.31	–	V	
COEF V <sub>FB</sub>	Temperature Feedback Thermal Coefficient	–	7.72	–	mV/°C	(22)
ACC T <sub>FB</sub>	Temperature Feedback Voltage Precision <ul style="list-style-type: none"> <li>Default</li> <li>1 calibration point at 25 °C and <math>V_{PWR} = 7.0\text{ V}</math></li> </ul>	-15 -5.0	– –	+15 +5.0	°C	(22)
t <sub>CSNS(SET)</sub>	Current Sense Settling Time <ul style="list-style-type: none"> <li>Current Sensing Feedback for I<sub>OUT</sub> from 75% FSR to 50% FSR</li> <li>Current Sensing Feedback for I<sub>OUT</sub> from 10% FSR to 1.0% FSR</li> <li>Temperature and Supply Voltage Feedbacks</li> </ul>	– – –	– – –	40 260 10	μs	(21)

**Notes**

- Precision either OCLO and ACM setting.
- Parameter is derived mainly from simulations.
- Parameter is guaranteed by design characterization. Measurements are taken from a statistically relevant sample size across process variations.
- Error of ±100% without calibration and ±50% with 1 calibration point done at 25 °C.

**Table 16. Electrical Characteristics**

Characteristics noted under conditions  $7.0\text{ V} \leq V_{PWR} \leq 18\text{ V}$ ,  $-40\text{ }^\circ\text{C} \leq T_A \leq 125\text{ }^\circ\text{C}$ ,  $\text{GND} = 0\text{ V}$ , unless otherwise noted. Typical values noted reflect the approximate parameter means at  $T_A = 25\text{ }^\circ\text{C}$  under nominal conditions, unless otherwise noted.

Symbol	Characteristic	Min	Typ	Max	Unit	Notes
<b>CURRENT SENSE CSNS (Continued)</b>						
$t_{CSNS(VAL)}$	Current Sense Valid Time				$\mu\text{s}$	(24)
	Current Sensing Feedback					
	• Low / Medium Frequency Ranges for $I_{OUT} > 20\%$ FSR	10	–	150		
	• Low / Medium Frequency Ranges for $I_{OUT} \leq 20\%$ FSR	70	–	300		
	• High Frequency Range for $I_{OUT} > 20\%$ FSR	5.0	–	75		
	• High Frequency Range for $I_{OUT} \leq 20\%$ FSR	70	–	300		
	Temperature Voltage Feedback	–	–	10		
	Supply Voltage Feedback	–	–	15		
$t_{SYNC}$ DEFAULT	Current Sense Synchronization Period for PWM Clock Failure	4.8	6.5	8.2	ms	
<b>CURRENT SENSE SYNCHRONIZATION CSNS SYNCB</b>						
$R_{CSNS SYNC}$	Pull-up Current Sense Synchronization Resistor Range	5.0	–	–	$\text{k}\Omega$	
$V_{OL}$	Current Sense Synchronization Logic Output Low State Level at 1.0 mA	–	–	0.4	V	
$I_{OUT max}$	Current Sense Synchronization Leakage Current in Tri-state (CSNS SYNC from 0 to 5.5 V)	-1.0	–	+1.0	$\mu\text{A}$	

**Notes**

24. Tested at 5% of final value @  $V_{PWR} = 14\text{ V}$ , current step from 0 A to 2.8 A (or 5.6 A). Parameter guaranteed by design at 1% of final value.

## 6.2 Power Supply Functional Block Description and Application Information

### 6.2.1 Introduction

The device is functional when  $\text{wake} = [1]$  with supply voltages from 5.5 to 40 V ( $V_{PWR}$ ), but is fully specification compliant only between 7.0 and 18 V. The  $V_{PWR}$  pin supplies power to the internal regulator, analog, and logic circuit blocks. The  $V_{CC}$  pin (5.0 V typ.) supplies the output register of the Serial Peripheral Interface (SPI) and the OUT6 driver. Consequently, the SPI registers cannot be read without presence of  $V_{CC}$ . The employed IC architecture guarantees a low quiescent current in Sleep mode ( $\text{wake} = [0]$ ).

### 6.2.2 Wake State Reporting

The CLK input/output pin is also used to report the wake state of the device to the microcontroller as long as RSTB is logic [0].

When the device is in:

- “wake state” and RSTB is inactive, the CLK pin reports a high signal (logic[1])
- “sleep mode” or the device is wake by the RSTB pin, the CLK is an input pin

## 6.2.2.1 Electrical Characterization

**Table 17. Electrical Characteristics**

Characteristics noted under conditions  $7.0\text{ V} \leq V_{PWR} \leq 18\text{ V}$ ,  $-40\text{ }^\circ\text{C} \leq T_A \leq 125\text{ }^\circ\text{C}$ ,  $\text{GND} = 0\text{ V}$ , unless otherwise noted. Typical values noted reflect the approximate parameter means at  $T_A = 25\text{ }^\circ\text{C}$  under nominal conditions, unless otherwise noted.

Symbol	Characteristic	Min	Typ	Max	Unit	Notes
<b>CLOCK INPUT/OUTPUT CLK</b>						
$V_{OH}$	Logic Output High State Level (CLK) at 1.0 mA	$V_{CC} - 0.6$	–	–	V	

## 6.2.3 Supply Voltages Disconnection

### 6.2.3.1 Loss of $V_{PWR}$

In case of  $V_{PWR}$  disconnection ( $V_{PWR} \leq V_{PWR\text{ POR}}$ ) the device behavior depends on  $V_{CC}$  voltage value:

- $V_{CC} \leq V_{CC\text{ POR}}$ : the device enters the power off mode. All outputs are shut off immediately. All registers and faults are cleared.
- $V_{CC} > V_{CC\text{ POR}}$ : all registers and faults are maintained. OUT1... 5 are shut off immediately. The ON/OFF state of OUT6 depends on the current SPI configuration. SPI reporting is available when  $V_{CC}$  remains within its operating voltage range (4.5 to 5.5 V).

The wake-up event is not reported to the CLK pin.

The clamping structures (supply clamp, negative output clamp) are available to protect the device.

No current is conducted from  $V_{CC}$  to  $V_{PWR}$ .

An external current path shall be available to drain the energy from an inductive load, in case a supply disconnection occurs when an output is ON.

### 6.2.3.2 Loss of $V_{CC}$

In case of a  $V_{CC}$  disconnection, the device behavior depends on  $V_{PWR}$  voltage:

- $V_{PWR} \leq V_{PWR\text{ POR}}$ : the device enters the power off mode. All outputs are shut off immediately. All registers and faults are cleared.
- $V_{PWR} > V_{PWR\text{ POR}}$ : the SPI is not available. Therefore, the device will enter WD timeout.

The clamping structures (supply clamp, negative output clamp) are available to protect the device.

No current is conducted from  $V_{PWR}$  to  $V_{CC}$ .

### 6.2.3.3 Loss of Device GND

During loss of ground, the device cannot drive the loads, therefore the OUT1... OUT5 outputs are switched off and the OUT6 voltage is pulled up.

The device shall not be damaged by this failure condition.

For protection of the digital inputs series resistors (1.0 k $\Omega$  typ) can be provided externally in order to limit the current to  $I_{CL}$ .



## 6.2.3.4 Electrical Characterization

**Table 18. Electrical Characteristics**

Characteristics noted under conditions  $7.0\text{ V} \leq V_{PWR} \leq 18\text{ V}$ ,  $-40\text{ }^\circ\text{C} \leq T_A \leq 125\text{ }^\circ\text{C}$ ,  $\text{GND} = 0\text{ V}$ , unless otherwise noted. Typical values noted reflect the approximate parameter means at  $T_A = 25\text{ }^\circ\text{C}$  under nominal conditions, unless otherwise noted.

Symbol	Characteristic	Min	Typ	Max	Unit	Notes
<b>SUPPLY VPWR</b>						
$V_{PWR\text{ POR}}$	Supply Power On Reset	2.0	3.0	4.0	V	
<b>VCC</b>						
$V_{CC\text{ POR}}$	VCC Power On Reset	2.0	3.0	4.0	V	
<b>GROUND GND</b>						
$V_{GND\text{ SHIFT}}$	Maximum Ground Shift between GND Pin and Load Grounds	-1.5	–	+1.5	V	

## 6.3 Communication Interface and Device Control Functional Block Description and Application Information

### 6.3.1 Introduction

In Normal mode, the power output channels are controlled by the embedded PWM module, which is configured by the SPI register settings. For bidirectional SPI communication,  $V_{CC}$  has to be in the authorized range. Failure diagnostics and configuration are also performed through the SPI port. The reported failure types are: OpenLoad, short-circuit to supply, severe short-circuit to ground, overcurrent, overtemperature, clock fail, and under and overvoltage.

For direct input control, the device shall be in Fail-safe mode.  $V_{CC}$  is not required and this mode can be forced by the LIMP input pin.

### 6.3.2 Fail Mode Input (LIMP)

The Fail mode of the component can be activated by LIMP direct input. The Fail mode is activated when the input is logic [1].

In Fail mode, the channel power outputs are controlled by the corresponding inputs. Even though the input thresholds are logic level compatible, the input structure of the pins are able to withstand supply voltage level (max. 40 V) without damage. External current limit resistors (i.e. 1.0 k $\Omega$ ...10 k $\Omega$ ) can be used to handle reverse current conditions. The direct inputs have an integrated pull-down resistor.

The LIMP input has an integrated pull-down resistor. The status of the LIMP input can be monitored by the LIMP IN bit inside the device status register #7.

#### 6.3.2.1 Electrical Characterization

**Table 19. Electrical Characteristics**

Characteristics noted under conditions  $4.5\text{ V} \leq V_{PWR} \leq 5.5\text{ V}$ ,  $-40\text{ }^\circ\text{C} \leq T_A \leq 125\text{ }^\circ\text{C}$ ,  $\text{GND} = 0\text{ V}$ , unless otherwise noted. Typical values noted reflect the approximate parameter means at  $T_A = 25\text{ }^\circ\text{C}$  under nominal conditions, unless otherwise noted.

Symbol	Characteristic	Min	Typ	Max	Unit	Notes
<b>FAIL MODE INPUT LIMP</b>						
$V_{IH}$	Logic Input High State Level	3.5	–	–	V	
$V_{IL}$	Logic Input Low State Level	–	–	1.5	V	
$I_{IN}$	Logic Input Leakage Current in Inactive State (LIMP = [0])	-0.5	–	+0.5	$\mu\text{A}$	
$R_{PULL}$	Logic Input Pull-down Resistor	25	–	100	k $\Omega$	

**Table 19. Electrical Characteristics**

Characteristics noted under conditions  $4.5\text{ V} \leq V_{PWR} \leq 5.5\text{ V}$ ,  $-40\text{ }^\circ\text{C} \leq T_A \leq 125\text{ }^\circ\text{C}$ ,  $\text{GND} = 0\text{ V}$ , unless otherwise noted. Typical values noted reflect the approximate parameter means at  $T_A = 25\text{ }^\circ\text{C}$  under nominal conditions, unless otherwise noted.

Symbol	Characteristic	Min	Typ	Max	Unit	Notes
$C_{IN}$	Logic Input Capacitance	–	–	20	pF	(25)

**DIRECT INPUTS IN1... IN4**

$V_{IH}$	Logic Input High State Level	3.5	–	–	V	
$V_{IH(WAKE)}$	Logic Input High State Level for wake-up	3.75	–	–	V	
$V_{IL}$	Logic Input Low State Level	–	–	1.5	V	
$I_{IN}$	Logic Input Leakage Current in Inactive State (forced to [0])	-0.5	–	+0.5	$\mu\text{A}$	
$R_{PULL}$	Logic Input Pull-down Resistor	25	–	100	$\text{k}\Omega$	
$C_{IN}$	Logic Input Capacitance	–	–	20	pF	(25)

## Notes

25. Parameter is derived mainly from simulations.

## 6.3.3 MCU Communication Interface Protections

### 6.3.3.1 Loss of Communication Interface

If a SPI communication error occurs, the device is switched into Fail mode.

A SPI communication fault is detected if:

- the WD bit is not toggled with each SPI message or
- WD timeout is reached or
- protocol length error (modulo 16 check)

The SI stuck to static levels during CSB period and VCC fail (SPI not functional) are indirectly detected by a WD toggle error.

The SPI communication error is reported in:

- SPI failure flag (SPIF) inside the device status register #7 in the next SPI communication

As long as the device is in Fail mode, the SPIF bit retains its state.

The SPIF bit is delatched during the transition from fail-to-normal modes.

### 6.3.3.2 Logic I/O Plausibility Check

The logic and signal I/O are protected against fatal mistreatment by a signal plausibility check, according following table:

I/O	Signal check strategy
IN1 ~ IN4	frequency above limit (low pass filter)
LMP	frequency above limit (low pass filter)
RST\	frequency above limit (low pass filter)
CLK	frequency above limit (low pass filter)

The LIMP and IN1... IN4 have an input symmetrically deglitch time  $t_{IN\_DGL} = 200\text{ }\mu\text{s}$  (typ).

If the LIMP input is set to logic [1] for a delay longer than  $200\text{ }\mu\text{s}$  typ, the device is switched into Fail mode (internal signal called iLIMP).

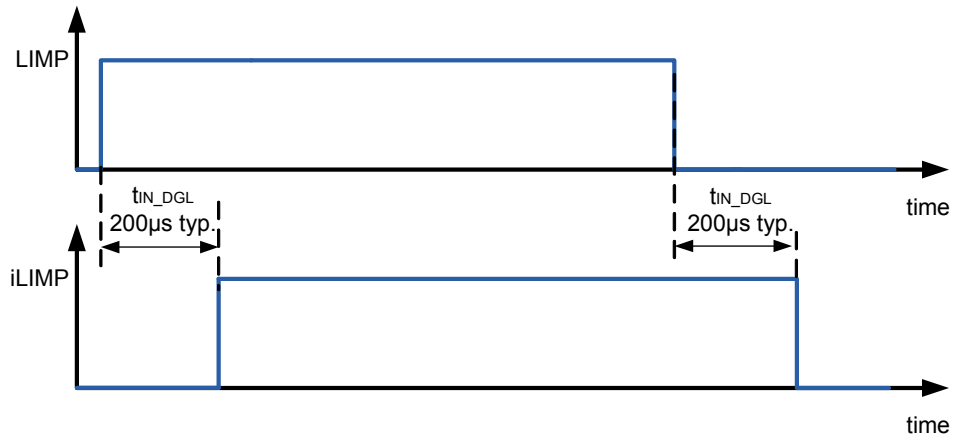

**Figure 34. LIMP and iLIMP signal**

In case the INx input is set to logic [1] for a delay longer than 200 µs (typ.), the corresponding channel is controlled by the direct signal (internal signal called iINx).

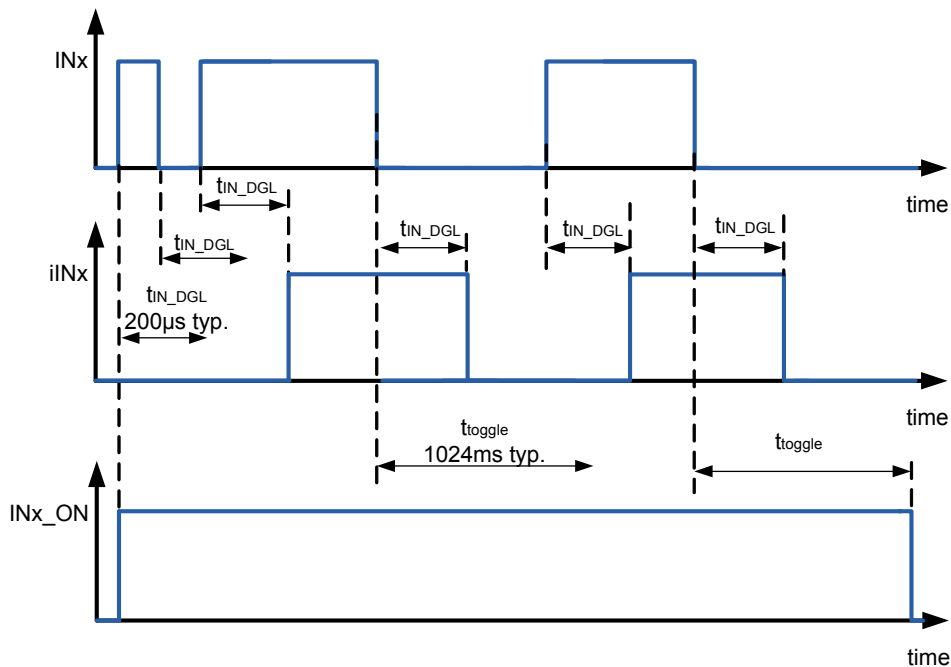

**Figure 35. IN, iIN and IN\_ON signal**

The RSTB has an input deglitch time  $t_{RST\_DGL} = 10 \mu s$  (typ) for the falling edge only.

The CLK has an input symmetrically deglitch time  $t_{CLK\_DGL} = 2.0 \mu s$  (typ). Due to the input deglitcher (at the CLK input) a very high input frequency leads to a clock fail detection.

The CLK fail detection (clock input frequency detection  $f_{CLK\_LOW}$ ) is started immediately with the positive edge of RSTB signal.

If the CLK frequency is below  $f_{CLK\_LOW}$  limit, the output state will depend on the corresponding CHx signal.

As soon as the CLK signal is valid, the output duty cycle depends on the corresponding SPI configuration.

To delatch the CLK fail diagnosis

- the clock failure condition must be removed
- a read command of the quick status register #1 must be performed

### 6.3.3.3 Electrical Characterization

**Table 20. Electrical Characteristics**

Characteristics noted under conditions  $7.0V \leq V_{PWR} \leq 18V$ ,  $-40^{\circ}C \leq T_A \leq 125^{\circ}C$ ,  $GND = 0V$ , unless otherwise noted. Typical values noted reflect the approximate parameter means at  $T_A = 25^{\circ}C$  under nominal conditions, unless otherwise noted.

Symbol	Characteristic	Min	Typ	Max	Unit	Notes
<b>LOGIC I/O LIMP IN1... IN4 CLK</b>						
$t_{WD}$	SPI Watchdog Timeout • WD SEL = 0 • WD SEL = 1	24 96	32 128	40 160	ms	
$t_{TOGGLE}$	Input Toggle Time for IN1... IN4	768	1024	1280	ms	
$t_{DGL}$	Input Deglitching Time • LIMP and IN1... IN4 • CLK • RST\	150 1.5 7.5	200 2.0 10	250 2.5 12.5	$\mu s$	
$f_{CLOCK LOW}$	Clock Low Frequency Detection	50	100	200	Hz	

### 6.3.4 External Smart Power Control (OUT6)

The device provides a control output to drive an external smart power device in Normal mode only.

The control is according to the channel 6 settings in the SPI input data register.

- The protection and current feedback of the external SmartMOS device are under the responsibility of the microcontroller.
- The output delivers a 5.0 V CMOS logic signal from  $V_{CC}$ .

The output is protected against overvoltage.

An external current limit resistor (i.e. 1.0 k $\Omega$ ...10 k $\Omega$ ) shall be used to handle negative output voltage conditions.

The output has an integrated pull-down resistor to provide a stable OFF condition in Sleep mode and Fail mode.

In case of a ground disconnection, the OUT6 voltage is pulled up. External components are mandatory to define the state of external smart power device and to limit possible reverse OUT6 current (i.e. resistor in series).

#### 6.3.4.1 Electrical Characterization

**Table 21. Electrical Characteristics**

Characteristics noted under conditions  $7.0 V \leq V_{PWR} \leq 18 V$ ,  $-40^{\circ}C \leq T_A \leq 125^{\circ}C$ ,  $GND = 0 V$ , unless otherwise noted. Typical values noted reflect the approximate parameter means at  $T_A = 25^{\circ}C$  under nominal conditions, unless otherwise noted.

Symbol	Characteristic	Min	Typ	Max	Unit	Notes
<b>EXTERNAL SMART POWER OUTPUT OUT6</b>						
$t_{OUT6 RISE}$	OUT6 Rising Edge for 100 pF capacitive load	–	–	5.0	$\mu s$	
$R_{OUT6 DWN}$	OUT6 Pull-down Resistor	5.0	10	20	k $\Omega$	
$V_{OH}$	Logic Output High State Level (OUT6)	$V_{CC} - 0.6$	–	–	V	
$V_{OL}$	Logic Output Low State Level (OUT6)	–	–	0.6	V	

# 7 Typical Applications

## 7.1 Introduction

The 07XSF517 is the latest achievement in drivers for all types of centralized lighting applications.

### 7.1.1 Application Diagram

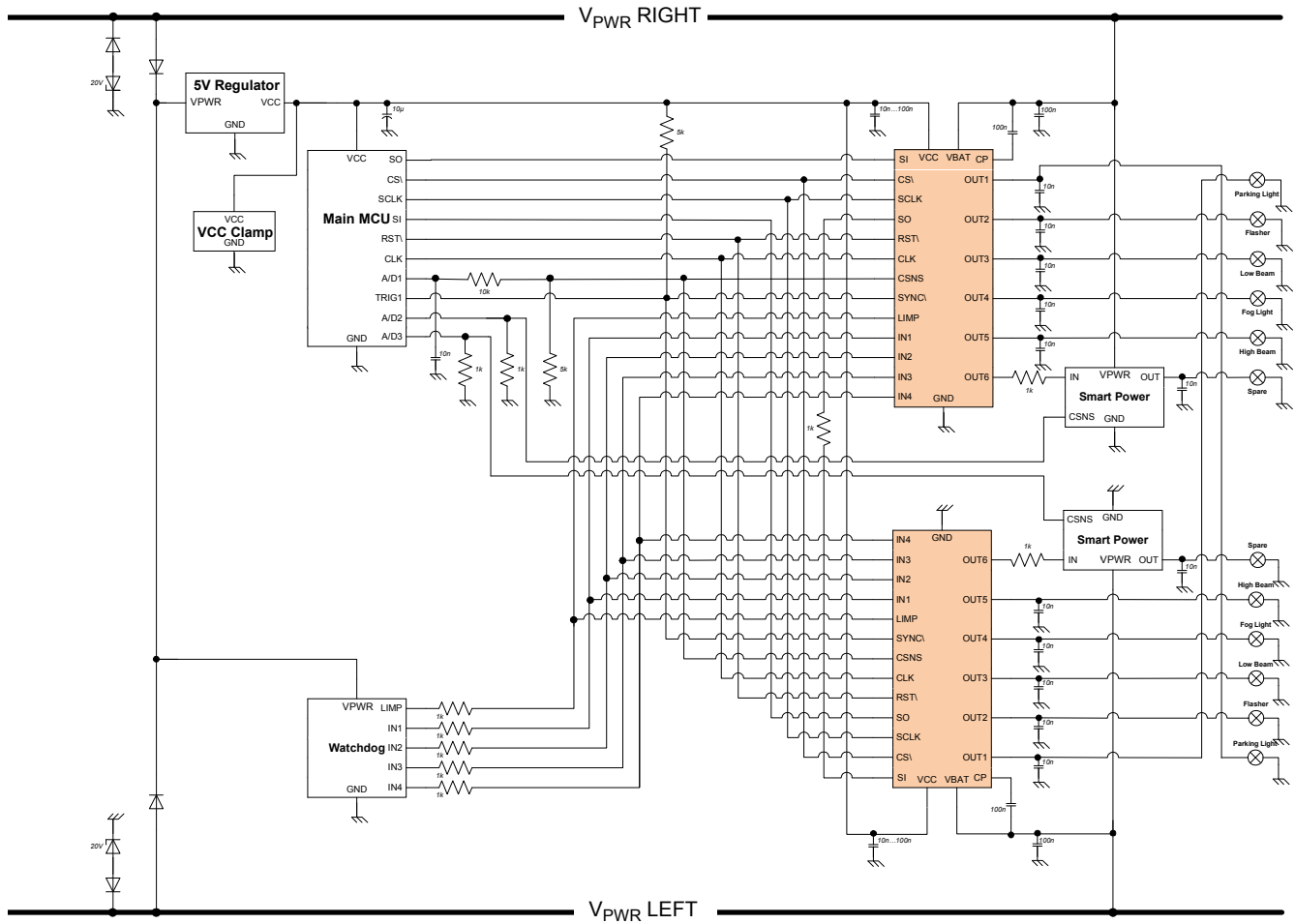

Figure 36. Typical Front Lighting Application for Automotive

## 7.1.2 Application Instructions

### 7.1.3 Bill of Material

Table 22. 07XSF517 Bill of Material (26)

Signal	Location	Mission	Value
V <sub>PWR</sub>	close to Gen4 eXtreme Switch	reduction of emission and immunity	100 nF (X7R 50 V)
CP	close to Gen4 eXtreme Switch	charge pump tank capacitor	100 nF (X7R 50 V)
V <sub>CC</sub>	close to Gen4 eXtreme Switch	reduction of emission and immunity	10 to 100 nF (X7R 16 V)
OUT1... OUT5	close to output connector	sustain ESG gun and fast transient pulses	10 to 22 nF (X7R 50 V)
CSNS	close to MCU	output current sensing	5.0 k (±1.0%)
CSNS	close to MCU	low pass filter removing noise	10 kΩ (±1.0%) & 10 nF (X7R 16V)
CSNS SYNCB	N/A	pull-up resistor for the synchronization of A/D conversion	5.0 k (±1.0%)
IN1... IN4	N/A	sustain high-voltage	1.0 kΩ (±1.0%)
OUT6	N/A	sustain reverse supply	1.0 kΩ (±1.0%)
To Increase Fast Transient Pulses Robustness			
V <sub>PWR</sub>	close to connector	sustain pulse #1 in case of LED loads or without loads	20 V zener diode and diode in series per supply line
V <sub>PWR</sub>	close to Gen4 eXtreme Switch	sustain pulse #2 without loads	additional 10 μF (X7R 50 V)
To Sustain 5.0 V Voltage Regulator Failure Mode			
V <sub>CC</sub>	close to 5.0 V voltage regulator	prevent high-voltage application on the MCU	5.0 V zener diode and a bipolar transistor

#### Notes

26. Freescale does not assume liability, endorse, or warrant components from external manufacturers that are referenced in circuit drawings or tables. While Freescale offers component recommendations in this configuration, it is the customer's responsibility to validate their application.

## 7.2 EMC and EMI Considerations

### 7.2.1 EMC/EMI Tests

This paragraph gives EMC/EMI performances, according to automotive specifications. Further generic design recommendations can be e.g. found on the Freescale website [www.freescale.com](http://www.freescale.com).

**Table 23. 07XSF517 EMC/EMI Performances**

Test	Signals	Conditions	Automotive Standard	Criteria
Conducted Emission	VPWR	outputs off outputs on in PWM	CISPR25	Class 5
	150 $\Omega$ Method Global pins: V <sub>PWR</sub> and OUT1... OUT5 Local pins: V <sub>CC</sub> , CP, and CSNS		IEC 61967-4	150 $\Omega$ Method Global pins: 12-K level Local pins: 10-J level
Conducted Immunity	Global pins: V <sub>PWR</sub> and OUT1... OUT5 Local pins: V <sub>CC</sub>		IEC 62132-4	Class A related to the outputs state and the analog diagnostics ( $\pm 20\%$ ) 30 dBm for Global pins 12 dBm for Local pins

### 7.2.2 Fast Transient Pulse Tests

This paragraph gives the device performances against fast transient disturbances.

**Table 24. 07XSF517 Fast Transient Capability on VPWR**

Test	Conditions	Automotive Standard	Criteria
Pulse 1	outputs loaded with lamps other cases with external transient voltage suppressor	ISO 7637-2	Class A
Pulse 2a			
Pulse 3a / 3b	outputs loaded outputs unloaded		
Pulse 5b (40 V)			

## 7.3 Robustness Considerations

The short-circuit protections embedded in 07XSF517 are preferred to conventional current limitations, to minimize the thermal overstress within the device in case of an overload condition. The junction temperature elevation is drastically reduced to a value which does not affect the device's reliability. Moreover, the availability of the lighting is guaranteed in fail mode by the unlimited autorestart feature.

The chapter 12 of AEC-Q100 specification published by the Automotive Electronics Council, presents turn-on into short-circuit condition. It is not enough, because the short-circuit event can also occur in on-state. The 07XSF517 test plan at  $T_A = 70\text{ }^\circ\text{C}$  is presented in [Table 25](#). The tests are performed on 30 parts from three engineering lots (total 90 pieces).

**Table 25. 07XSF517 Repetitive Short-circuit Test Results at  $T_A = 70\text{ }^\circ\text{C}$**

Short-circuit Case	Supply Voltage	Supply Line	Load Line	7.0 m $\Omega$ output cycle without Failure	17 m $\Omega$ output cycle without Failure
Turn-on into short-circuit condition	16 V	0.3 m / 2.5 mm <sup>2</sup>	5.0 m / 1.0 mm <sup>2</sup>	500 k	500 k
			0.3 m / 1.0 mm <sup>2</sup>	500 k	500 k
		5.0 m / 2.5 mm <sup>2</sup>		500 k	500 k
Short-circuit in On-state <sup>(27)</sup>	14 V	0.3 m / 2.5 mm <sup>2</sup>	5.0 m / 1.0 mm <sup>2</sup>	500 k	500 k
			0.3 m / 1.0 mm <sup>2</sup>	500 k	500 k
		5.0 m / 2.5 mm <sup>2</sup>		500 k	500 k
On-state overload 95% of min OCHI1/2/3 levels	16 V	1.0 m / 6.0 mm <sup>2</sup>	2.6 m / 6.0 mm <sup>2</sup> in series with 0.3 m / 1.0 mm <sup>2</sup>	250 k	500 k
On-state overload 95% of min OCHI1/2/3 levels with thermal OCHI feature active	16 V	1.0 m / 6.0 mm <sup>2</sup>	2.6 m / 6.0 mm <sup>2</sup> in series with 0.3 m / 1.0 mm <sup>2</sup>	500 k	500 k

Notes

27. The channel was loaded in the on-state with 100 mA.

**Table 26. 07XSF517 AECQ100-12 Reliability Test Results at  $T_A = 85\text{ }^\circ\text{C}$  and Supply Voltage = 14 V**

Short-circuit Case	Supply Line	Load Line	AECQ100-12 Grade
Load short-circuit on 7.0 m $\Omega$ Output	5.0 $\mu$ H/10 m $\Omega$	5.0 $\mu$ H/50 m $\Omega$	D
Load short-circuit on 17.0 m $\Omega$ Output		5.0 $\mu$ H/100 m $\Omega$	D

For either condition, contact our local Field Application Engineer (email: [support@freescale.com](mailto:support@freescale.com)).



## 7.4 PCB Layout Recommendations

This new generation of high-side switch products family facilitates ECU design thanks to compatible MCU software and PCB foot print for each device variant. The PCB Copper layer is similar for all devices in the family, only the solder Stencil opening is different.

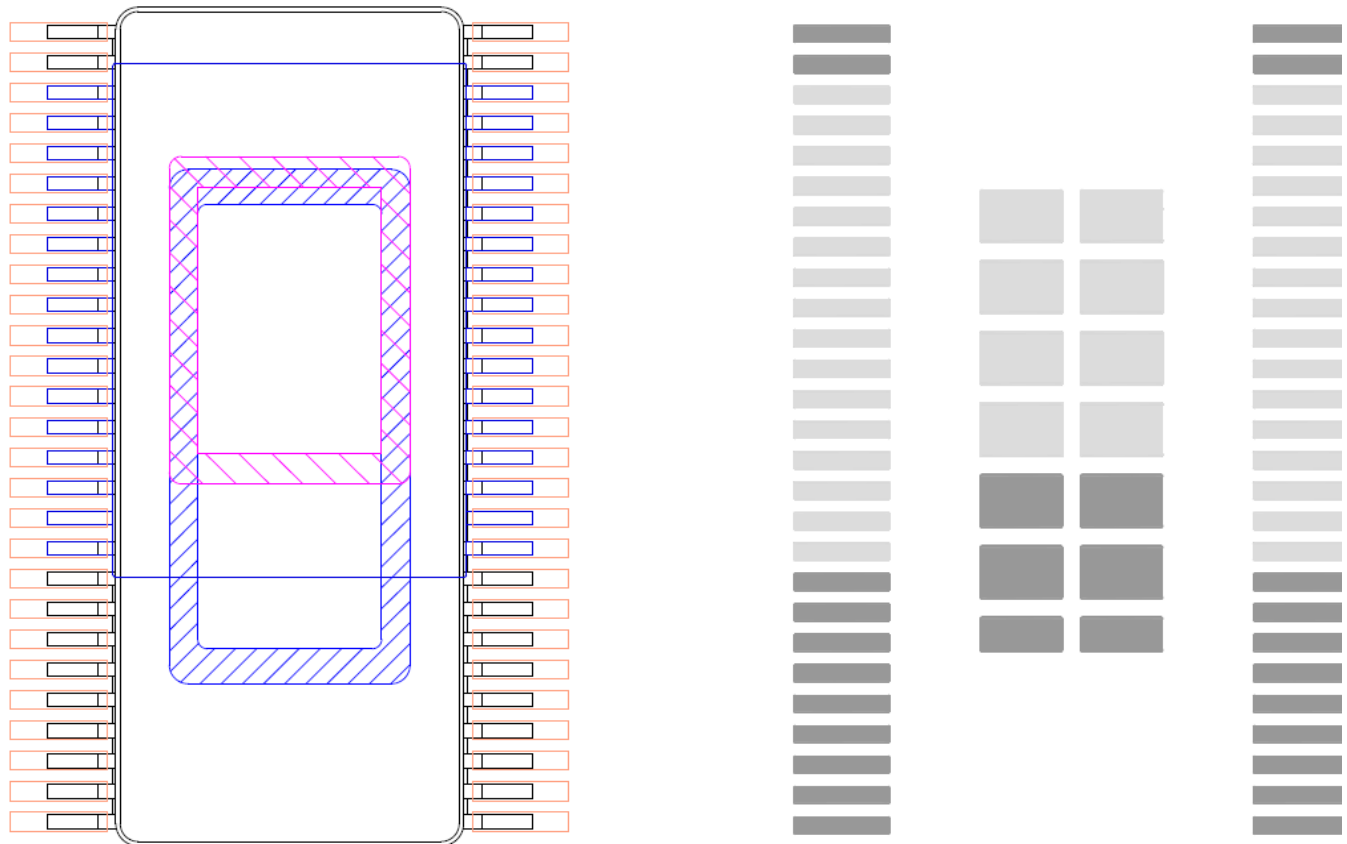

Figure 37. PCB Copper Layer & Solder Stencil Opening Recommendations

## 7.5 Thermal Information

This section is to provide thermal information.

### 7.5.1 Thermal Transient

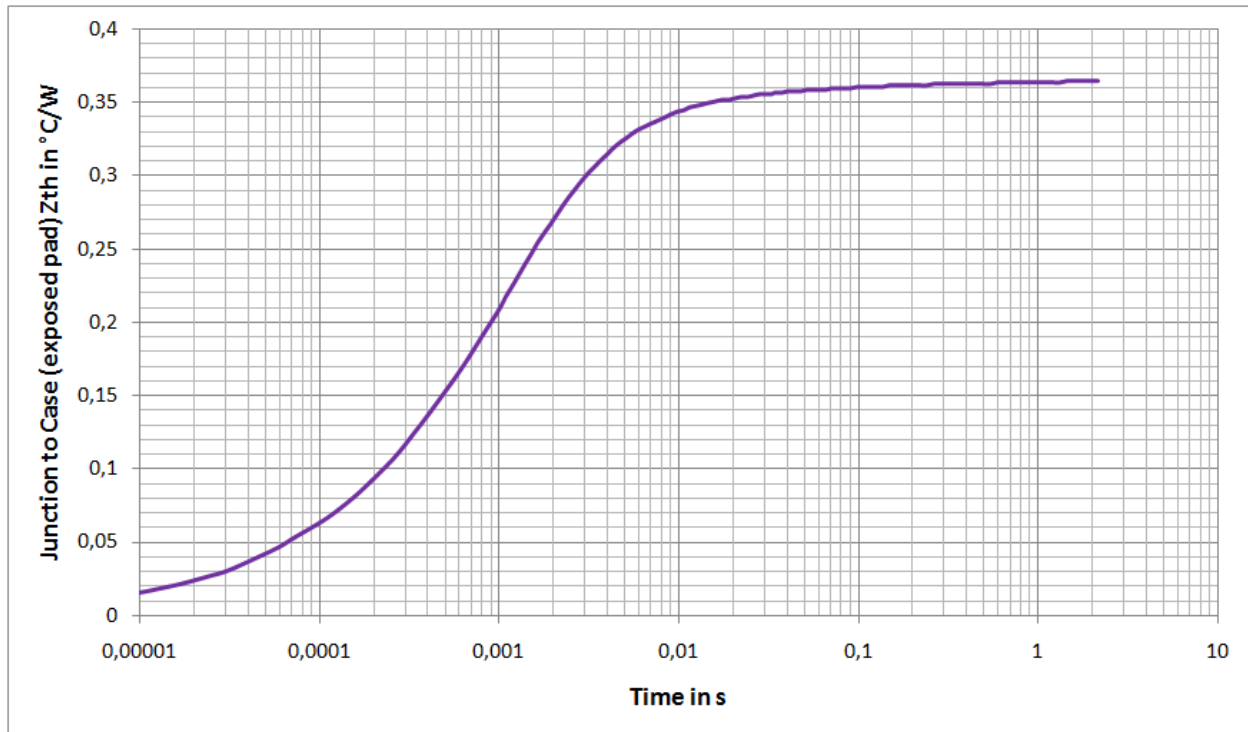

Figure 38. Transient Thermal Response Curve

### 7.5.2 R/C Thermal Model

Contact our local Field Application Engineer (email: [support@freescale.com](mailto:support@freescale.com)).

## 8 Packaging

### 8.1 Marking Information

Device markings indicate information on the week and year of manufacturing. The date is coded with the last four characters of the nine character build information code (e.g. “CTKAH1229”). The date is coded as four numerical digits where the first two digits indicate the year and the last two digits indicate the week. For instance, the date code “1229” indicates the 29<sup>th</sup> week of the year 2012.

### 8.2 Package Mechanical Dimensions

Package dimensions are provided in package drawings. To find the most current package outline drawing, go to [www.freescale.com](http://www.freescale.com) and perform a keyword search for the drawing's document number.

**Table 27. Package Outline**

Package	Suffix	Package Outline Drawing Number
54-Pin SOICEP	EK	98ASA00367D

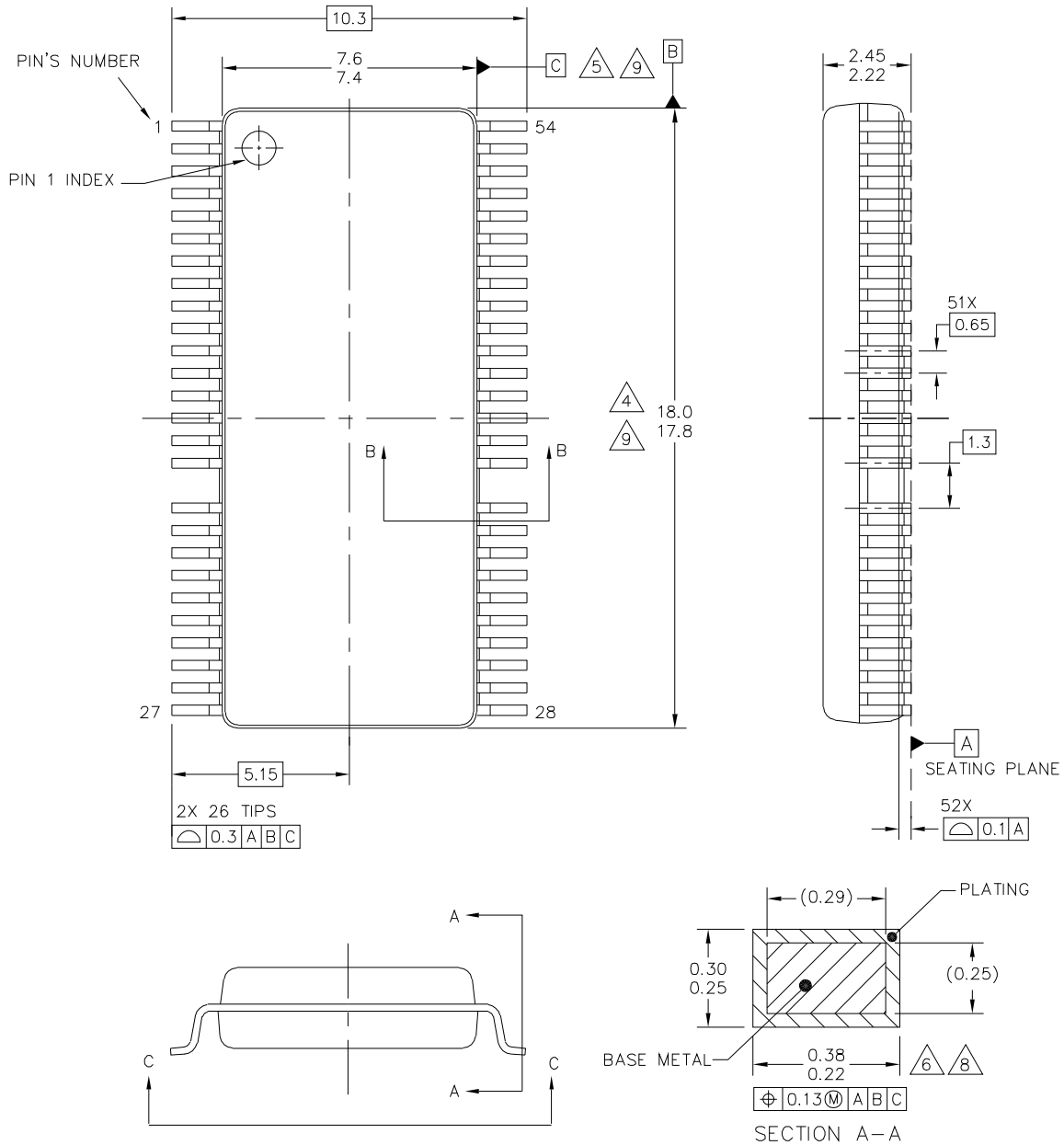

© FREESCALE SEMICONDUCTOR, INC. ALL RIGHTS RESERVED.	MECHANICAL OUTLINE	PRINT VERSION NOT TO SCALE	
TITLE: SOIC W/B, TOOTH GAP DESIGN, 54 TERMINAL, 0.65 PITCH, 4.5 X 10.3 EXPOSED PAD	DOCUMENT NO: 98ASA00367D	REV: 0	
	CASE NUMBER: 2181-01	14 JUL 2011	
	STANDARD: NON-JEDEC		

**EK SUFFIX**  
54-PIN SOIC-EP  
98ASA00367D  
ISSUE 0

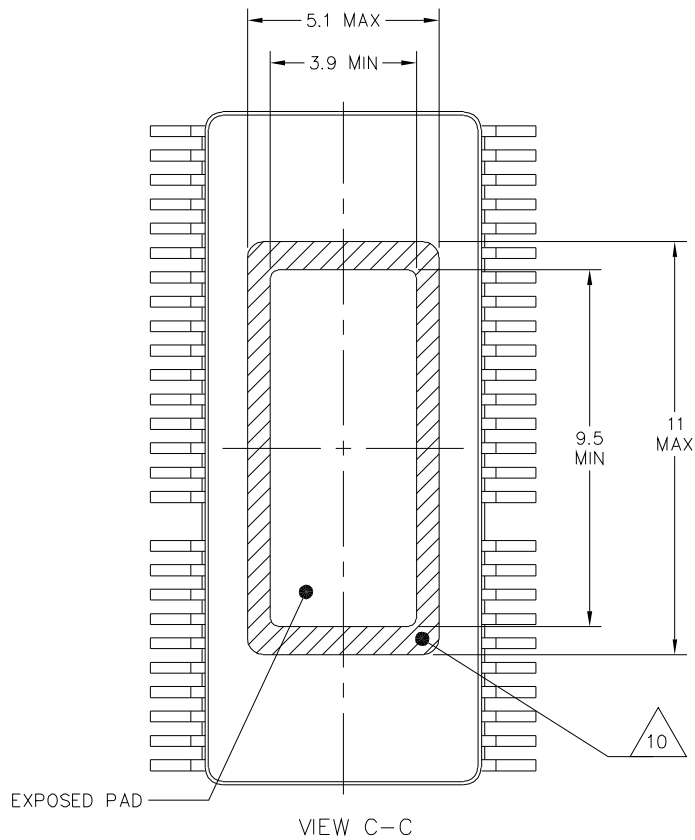
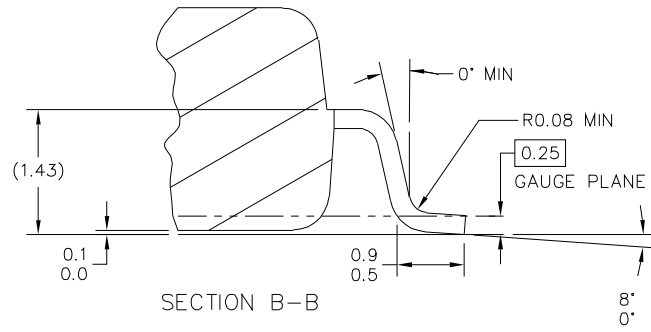

© FREESCALE SEMICONDUCTOR, INC. ALL RIGHTS RESERVED.	MECHANICAL OUTLINE	PRINT VERSION NOT TO SCALE	
TITLE: SOIC W/B, TOOTH GAP DESIGN, 54 TERMINAL, 0.65 PITCH, 4.5 X 10.3 EXPOSED PAD	DOCUMENT NO: 98ASA00367D	REV: 0	
	CASE NUMBER: 2181-01	14 JUL 2011	
	STANDARD: NON-JEDEC		

**EK SUFFIX**  
54-PIN SOIC-EP  
98ASA00367D  
ISSUE 0

NOTES:

1. DIMENSIONS ARE IN MILLIMETERS.
2. DIMENSIONING AND TOLERANCING PER ASME Y14.5M-1994.
3. DATUMS B AND C TO BE DETERMINED AT THE PLANE WHERE THE BOTTOM OF THE LEADS EXIT THE PLASTIC BODY.
4. THIS DIMENSION DOES NOT INCLUDE MOLD FLASH, PROTRUSION OR GATE BURRS. MOLD FLASH, PROTRUSION OR GATE BURRS SHALL NOT EXCEED 0.15 MM PER SIDE. THIS DIMENSION IS DETERMINED AT THE PLANE WHERE THE BOTTOM OF THE LEADS EXIT THE PLASTIC BODY.
5. THIS DIMENSION DOES NOT INCLUDE INTER-LEAD FLASH OR PROTRUSIONS. INTER-LEAD FLASH AND PROTRUSIONS SHALL NOT EXCEED 0.25 MM PER SIDE. THIS DIMENSION IS DETERMINED AT THE PLANE WHERE THE BOTTOM OF THE LEADS EXIT THE PLASTIC BODY.
6. THIS DIMENSION DOES NOT INCLUDE DAMBAR PROTRUSION. ALLOWABLE DAMBAR PROTRUSION SHALL NOT CAUSE THE LEAD WIDTH TO EXCEED 0.46 mm. DAMBAR CANNOT BE LOCATED ON THE LOWER RADIUS OR THE FOOT. MINIMUM SPACE BETWEEN PROTRUSION AND ADJACENT LEAD SHALL NOT BE LESS THAN 0.07 mm.
7. EXACT SHAPE OF EACH CORNER IS OPTIONAL.
8. THESE DIMENSIONS APPLY TO THE FLAT SECTION OF THE LEAD BETWEEN 0.1 mm AND 0.3 mm FROM THE LEAD TIP.
9. THE PACKAGE TOP MAY BE SMALLER THAN THE PACKAGE BOTTOM. THIS DIMENSION IS DETERMINED AT THE OUTERMOST EXTREMES OF THE PLASTIC BODY EXCLUSIVE OF MOLD FLASH, TIE BAR BURRS, GATE BURRS AND INTER-LEAD FLASH, BUT INCLUDING ANY MISMATCH BETWEEN THE TOP AND BOTTOM OF THE PLASTIC BODY.
10. HATCHED AREA TO BE KEEP OUT ZONE FOR PCB ROUTING.

© FREESCALE SEMICONDUCTOR, INC. ALL RIGHTS RESERVED.	MECHANICAL OUTLINE	PRINT VERSION NOT TO SCALE	
TITLE: SOIC W/B, TOOTH GAP DESIGN, 54 TERMINAL, 0.65 PITCH, 4.5 X 10.3 EXPOSED PAD	DOCUMENT NO: 98ASA00367D	REV: 0	
	CASE NUMBER: 2181-01	14 JUL 2011	
	STANDARD: NON-JEDEC		

**EK SUFFIX**  
54-PIN SOIC-EP  
98ASA00367D  
ISSUE 0

## 9 Revision History

REVISION	DATE	DESCRIPTION OF CHANGES
1.0	9/2013	<ul style="list-style-type: none"><li>Initial release</li></ul>
2.0	9/2013	<ul style="list-style-type: none"><li>Added the note "To achieve high reliability over 10 years of continuous operation, the device's continuous operating junction temperature should not exceed 125 °C." to <a href="#">Operating Temperature</a></li></ul>



**How to Reach Us:**

**Home Page:**  
freescale.com

**Web Support:**  
freescale.com/support

Information in this document is provided solely to enable system and software implementers to use Freescale products. There are no express or implied copyright licenses granted hereunder to design or fabricate any integrated circuits based on the information in this document.

Freescale reserves the right to make changes without further notice to any products herein. Freescale makes no warranty, representation, or guarantee regarding the suitability of its products for any particular purpose, nor does Freescale assume any liability arising out of the application or use of any product or circuit, and specifically disclaims any and all liability, including without limitation consequential or incidental damages. "Typical" parameters that may be provided in Freescale data sheets and/or specifications can and do vary in different applications, and actual performance may vary over time. All operating parameters, including "typicals," must be validated for each customer application by customer's technical experts. Freescale does not convey any license under its patent rights nor the rights of others. Freescale sells products pursuant to standard terms and conditions of sale, which can be found at the following address: [freescale.com/SalesTermsandConditions](http://freescale.com/SalesTermsandConditions).

Freescale and the Freescale logo, are trademarks of Freescale Semiconductor, Inc., Reg. U.S. Pat. & Tm. Off. SMARTMOS is a trademark of Freescale Semiconductor, Inc. All other product or service names are the property of their respective owners.

© 2013 Freescale Semiconductor, Inc.

Document Number: MC07XSF517  
Rev. 2.0  
9/2013

