

Rx Coil Units

WR483265-15F5-G

■ SHAPE & DIMENSIONS

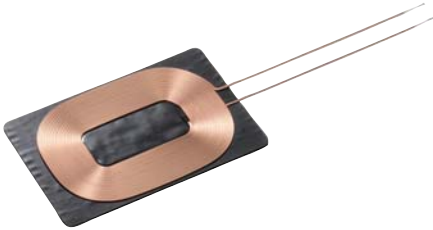
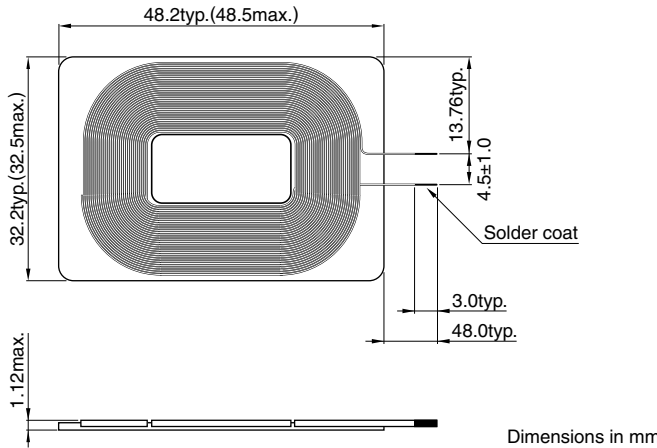

■ ELECTRICAL CHARACTERISTICS

□ CHARACTERISTICS SPECIFICATION TABLE

LxW Dimensions (mm)	Thickness (mm)max.	Efficiency* (%)ref.	Inductance (μH) [100kHz, 1Vrms]	DC resistance (Ω)max. [25°C]	Part No.
48.0x32.0	1.25	73	13.3	0.20	WR483265-15F5-G

* Contact us for more information.