

Rx Coil Units

WR303050-15F5-G

■ SHAPE & DIMENSIONS

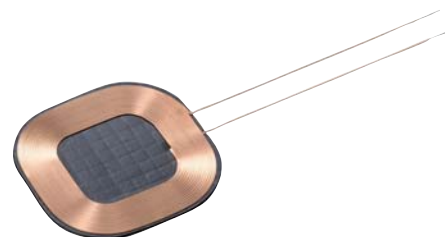
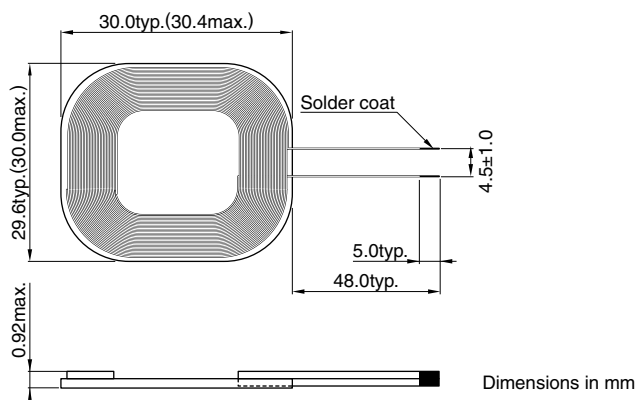

■ ELECTRICAL CHARACTERISTICS

□ CHARACTERISTICS SPECIFICATION TABLE

LxW Dimensions (mm)	Thickness (mm)max.	Efficiency* (%)ref.	Inductance (μH) [100kHz, 1Vrms]	DC resistance (Ω)max. [25°C]	Part No.
30.0x30.0	1.00	66	12.3	0.41	WR303050-15F5-G

* Contact us for more information.