

500mA Peak, Thermal Folded Back CMOS LDO Regulator

General Description

The RT9017 is designed for portable RF and wireless applications with demanding performance and space requirements. The RT9017 performance is optimized for battery-powered systems to deliver ultra low noise and low quiescent current. Regulator ground current increases only slightly in dropout, further prolonging the battery life. The RT9017 also works with low-ESR ceramic capacitors, reducing the amount of board space necessary for power applications, critical in hand-held wireless devices. The RT9017 consumes less than 0.01μA in shutdown mode and has fast turn-on time less than 50μs. RT9017 is short circuit thermal folded back protected. RT9017 lowers its OTP trip point from 165°C to 110°C when output short circuit occurs ($V_{OUT} < 0.4V$) providing maximum safety to end users. The other features include ultra low dropout voltage, high output accuracy, current limiting protection, and high ripple rejection ratio. Available in the SOT-23-3, SOT-23-5 and WDFN-6L 2x2 packages, the RT9017 also offers a range of 1.5V to 3.5V with 0.1V per step.

Ordering Information

RT9017-□□□□	
	Package Type
	V : SOT-23-3
	B : SOT- 23-5
	BR : SOT- 23-5 (R-Type)
	QW : WDFN-6L 2x2 (W-Type)
	Lead Plating System
	P : Pb Free
	G : Green (Halogen Free and Pb Free)
	Output Voltage
	15 : 1.5V
	16 : 1.6V
	:
	34 : 3.4V
	35 : 3.5V
	1H : 1.85V
	2H : 2.85V

Note :

Richtek products are :

- ▶ RoHS compliant and compatible with the current requirements of IPC/JEDEC J-STD-020.
- ▶ Suitable for use in SnPb or Pb-free soldering processes.

Features

- Short Circuit Thermal Folded Back Protection
- Low-Noise for RF Application
- Fast Response in Line/Load Transient
- Quick Start-Up (Typically 50μs)
- 0.01μA Standby Current When Shutdown
- Low Dropout : 380mV @ 500mA
- Wide Operating Voltage Ranges : 2.5V to 5.5V
- TTL-Logic-Controlled Shutdown Input
- Low Temperature Coefficient
- Current Limiting Protection
- Thermal Shutdown Protection
- Only 1μF Output Capacitor Required for Stability
- High Power Supply Rejection Ratio
- Custom Voltage Available
- RoHS Compliant and 100% Lead (Pb)-Free

Applications

- CDMA/GSM Cellular Handsets
- Battery-Powered Equipment
- Laptop, Palmtops, Notebook Computers
- Hand-Held Instruments
- PCMCIA Cards
- Portable Information Appliances

Marking Information

For marking information, contact our sales representative directly or through a Richtek distributor located in your area.

Pin Configurations

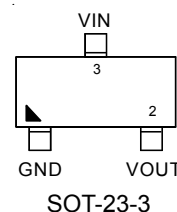
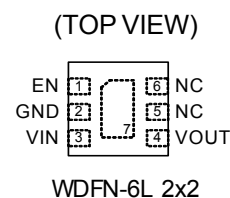

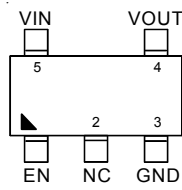

SOT-23-5

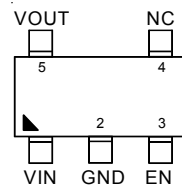

SOT-23-5 (R-Type)

Typical Application Circuit

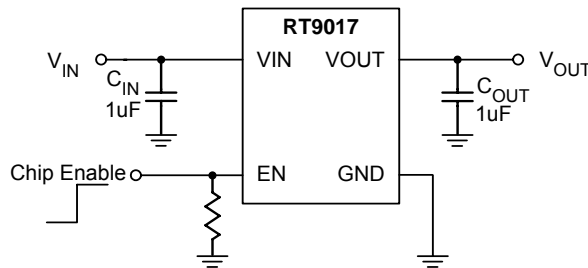

Functional Pin Description

Pin Name	Pin Function
EN	Chip Enable (Active High). Note that this pin is high impedance. There should be a pull low 100kΩ resistor connected to GND when the control signal is floating.
NC	No Internal Connection.
GND	Ground.
VOUT	Output Voltage.
VIN	Input Voltage.

Function Block Diagram

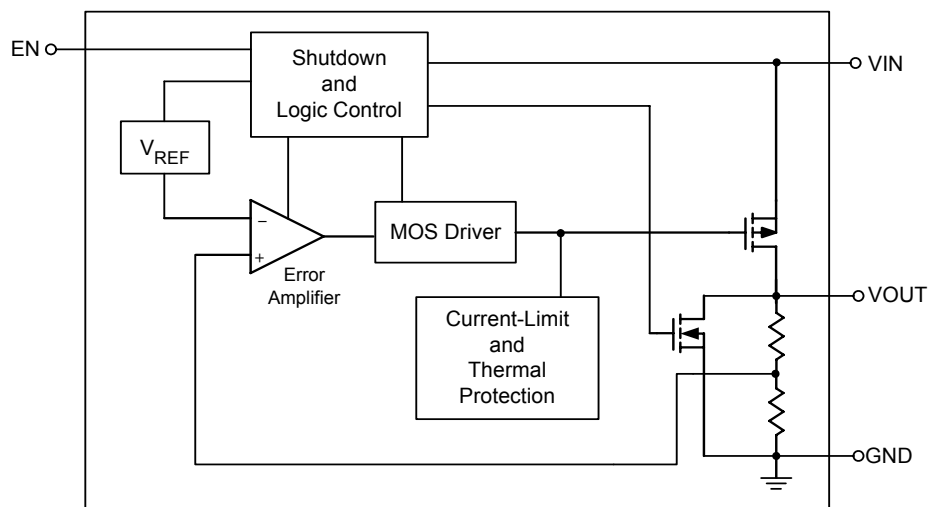

Absolute Maximum Ratings (Note 1)

- Supply Input Voltage ----- 6V
- Power Dissipation, P_D @ $T_A = 25^\circ\text{C}$
 - SOT-23-3 ----- 400mW
 - SOT-23-5 ----- 400mW
 - WDFN-6L 2x2 ----- 606mW
- Package Thermal Resistance (Note 2)
 - SOT-23-3, θ_{JA} ----- 250°C/W
 - SOT-23-5, θ_{JA} ----- 250°C/W
 - WDFN-6L 2x2, θ_{JA} ----- 165°C/W
- Junction Temperature ----- 150°C
- Lead Temperature (Soldering, 10 sec.) ----- 260°C
- Storage Temperature Range ----- -65°C to 150°C
- ESD Susceptibility (Note 3)
 - HBM (Human Body Mode) ----- 2kV
 - MM (Machine Mode) ----- 200V

Recommended Operating Conditions (Note 4)

- Supply Input Voltage ----- 2.5V to 5.5V
- Junction Temperature Range ----- -40°C to 125°C
- Ambient Temperature Range ----- -40°C to 85°C

Electrical Characteristics

($V_{IN} = V_{OUT} + 1V$, $C_{IN} = C_{OUT} = 1\mu\text{F}$, $T_A = 25^\circ\text{C}$, unless otherwise specified)

Parameter	Symbol	Test Conditions	Min	Typ	Max	Unit	
Output Voltage Accuracy	ΔV_{OUT}	$I_{OUT} = 1\text{mA}$	-2	--	+2	%	
Current Limit	I_{LIM}	$R_{LOAD} = 1\Omega$	530	--	--	mA	
Quiescent Current	I_Q	$V_{EN} \geq 1.2V$, $I_{OUT} = 0\text{mA}$	--	90	130	μA	
Dropout Voltage (Note 5)	V_{DROP}	$I_{OUT} = 300\text{mA}$, $V_{OUT} > 2.8V$	--	220	--	mV	
		$I_{OUT} = 500\text{mA}$, $V_{OUT} > 2.8V$	--	380	--		
Line Regulation	ΔV_{LINE}	$V_{IN} = (V_{OUT} + 1V)$ to 5.5V, $I_{OUT} = 1\text{mA}$	--	--	0.3	%	
Load Regulation	ΔV_{LOAD}	$1\text{mA} < I_{OUT} < 500\text{mA}$	--	--	0.6	%	
Standby Current	I_{STBY}	$V_{EN} = \text{GND}$, Shutdown	--	0.01	1	μA	
EN Input Bias Current	I_{IBSD}	$V_{EN} = \text{GND}$ or V_{IN}	--	0	100	nA	
EN Threshold	Logic-Low Voltage	V_{IL}	--	--	0.4	V	
	Logic-High Voltage	V_{IH}	1.2	--	--		
Power Supply Rejection Rate	f = 100Hz	PSRR	$C_{OUT} = 1\mu\text{F}$, $I_{OUT} = 100\text{mA}$	--	-60	--	dB
	f = 10kHz			--	-30	--	
Thermal Shutdown Temperature	T_{SD}		--	165	--	$^\circ\text{C}$	
Thermal Shutdown Temperature Hysteresis	ΔT_{SD}		--	30	--	$^\circ\text{C}$	
Thermal Folded Back			--	110	--	$^\circ\text{C}$	

- Note 1.** Stresses listed as the above "Absolute Maximum Ratings" may cause permanent damage to the device. These are for stress ratings. Functional operation of the device at these or any other conditions beyond those indicated in the operational sections of the specifications is not implied. Exposure to absolute maximum rating conditions for extended periods may remain possibility to affect device reliability.
- Note 2.** θ_{JA} is measured in the natural convection at $T_A = 25^\circ\text{C}$ on a low effective single layer thermal conductivity test board of JEDEC 51-3 thermal measurement standard.
- Note 3.** Devices are ESD sensitive. Handling precaution is recommended.
- Note 4.** The device is not guaranteed to function outside its operating conditions.
- Note 5.** The dropout voltage is defined as $V_{IN} - V_{OUT}$, which is measured when V_{OUT} is $V_{OUT(NORMAL)} - 100\text{mV}$.

Typical Operating Characteristics

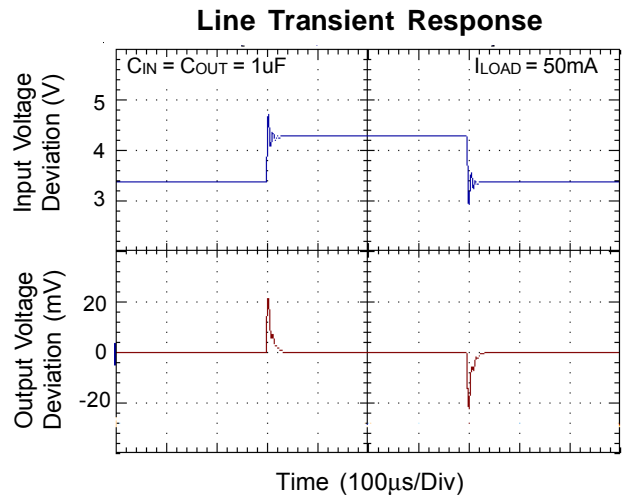
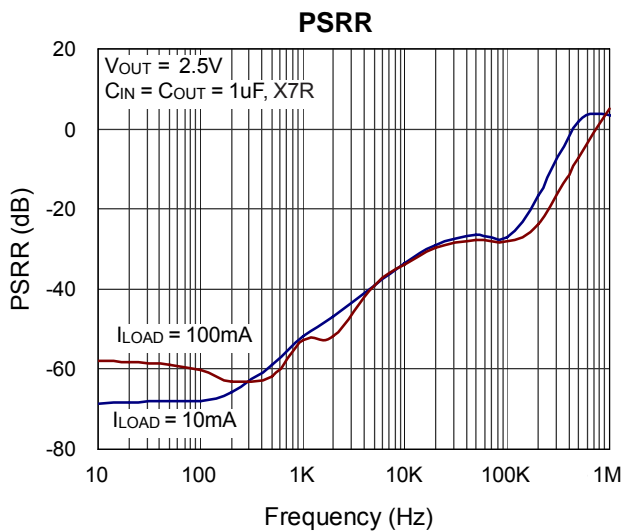
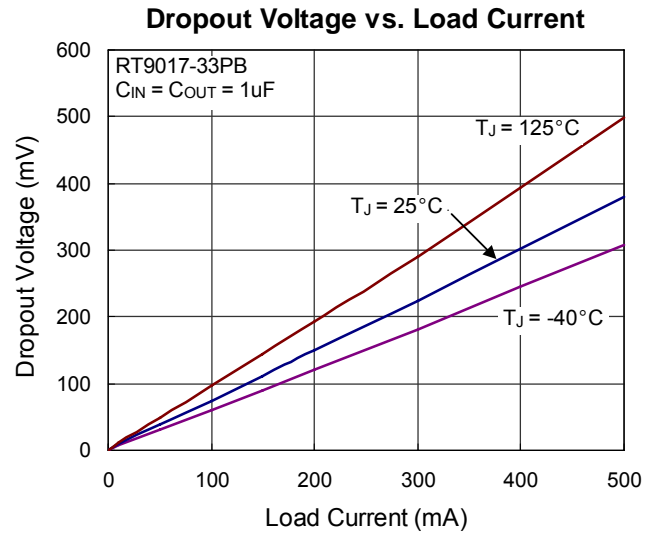
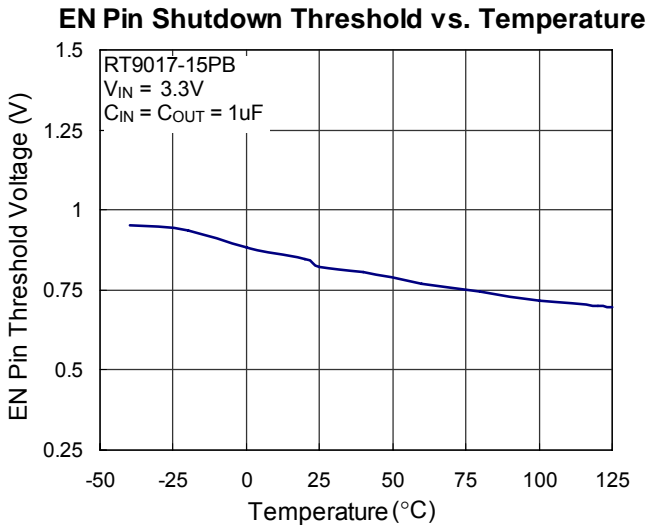
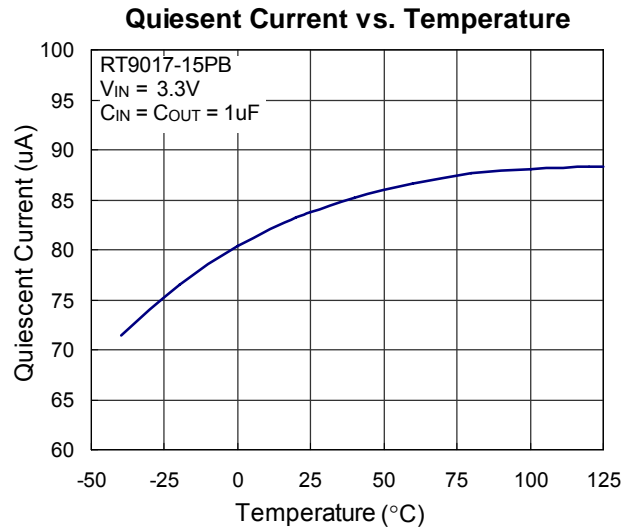
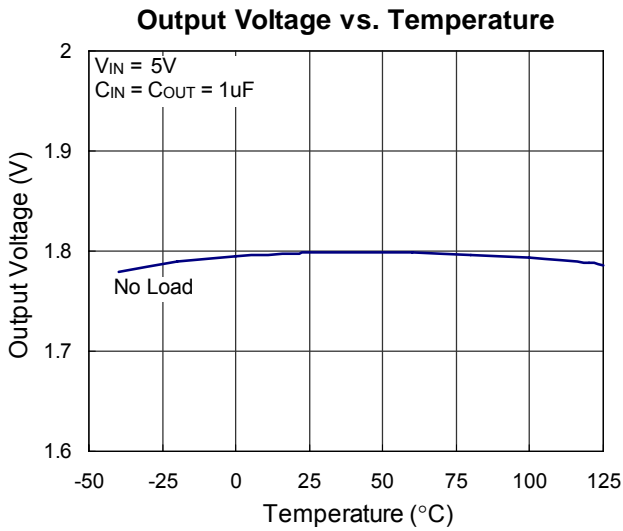

Line Transient Response

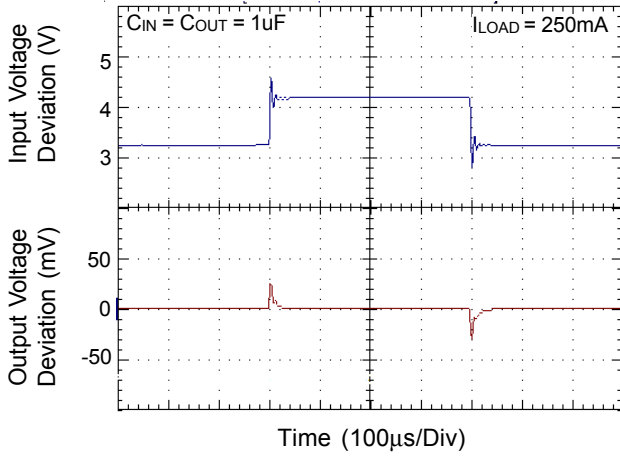

Load Transient Response

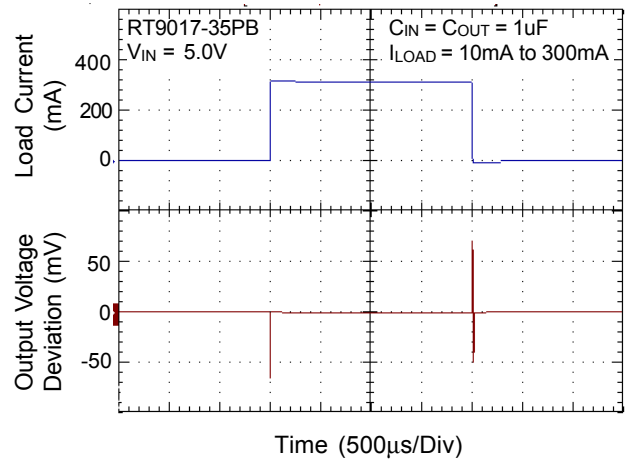

Load Transient Response

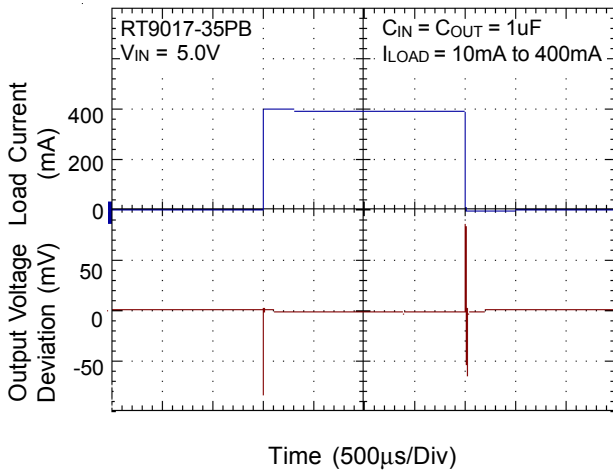

Start Up

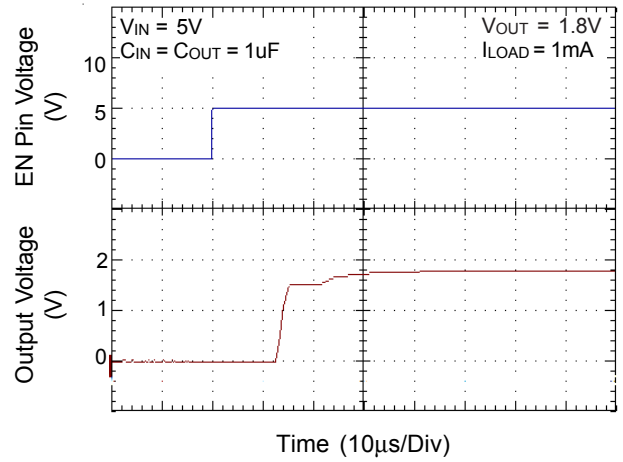

EN Pin Shutdown Response

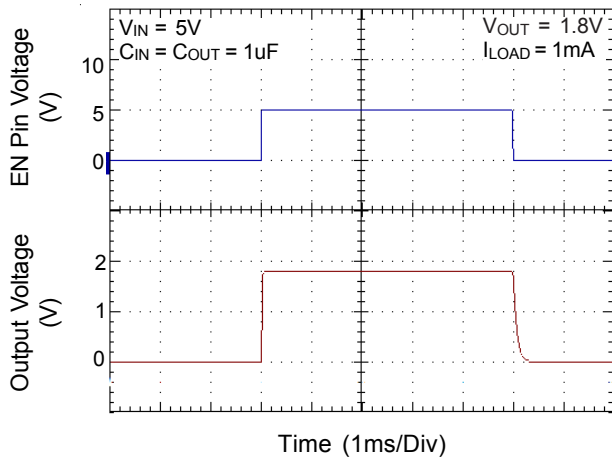

Noise

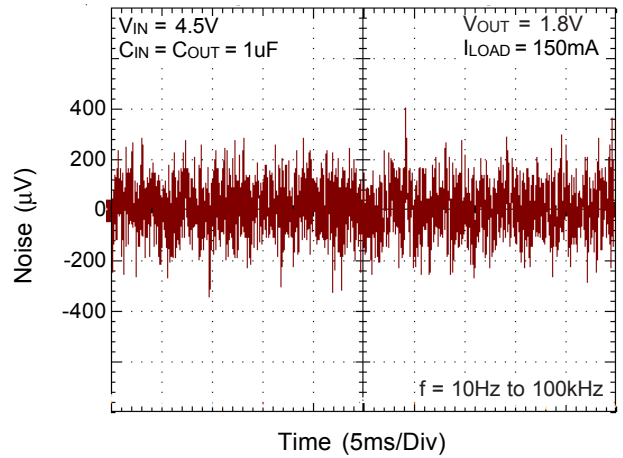

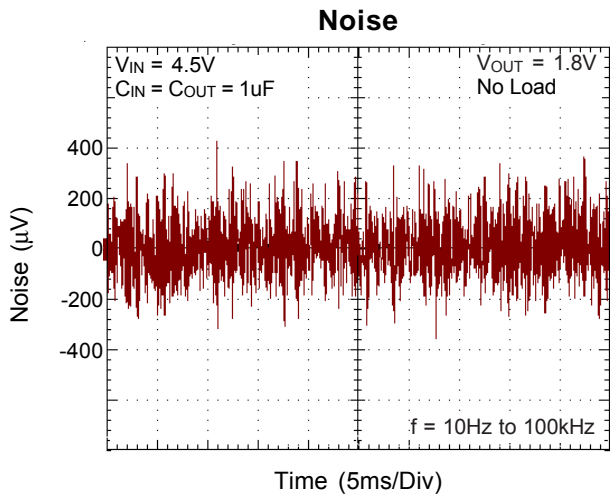

Applications Information

Like any low-dropout regulator, the external capacitors used with the RT9017 must be carefully selected for regulator stability and performance. Using a capacitor whose value is $> 1\mu\text{F}$ on the RT9017 input and the amount of capacitance can be increased without limit. The input capacitor must be located a distance of not more than 0.5 inch from the input pin of the IC and returned to a clean analog ground. Any good quality ceramic or tantalum can be used for this capacitor. The capacitor with larger value and lower ESR (equivalent series resistance) provides better PSRR and line-transient response.

The output capacitor must meet both requirements for minimum amount of capacitance and ESR in all LDOs application. The RT9017 is designed specifically to work with low ESR ceramic output capacitor in space-saving and performance consideration. Using a ceramic capacitor whose value is at least $1\mu\text{F}$ with ESR is $> 20\text{m}\Omega$ on the RT9017 output ensures stability. The RT9017 still works well with output capacitor of other types due to the wide stable ESR range. Figure 1. shows the curves of allowable ESR range as a function of load current for various output capacitor values. Output capacitor of larger capacitance can reduce noise and improve load transient response, stability, and PSRR. The output capacitor should be located not more than 0.5 inch from the V_{OUT} pin of the RT9017 and returned to a clean analog ground.

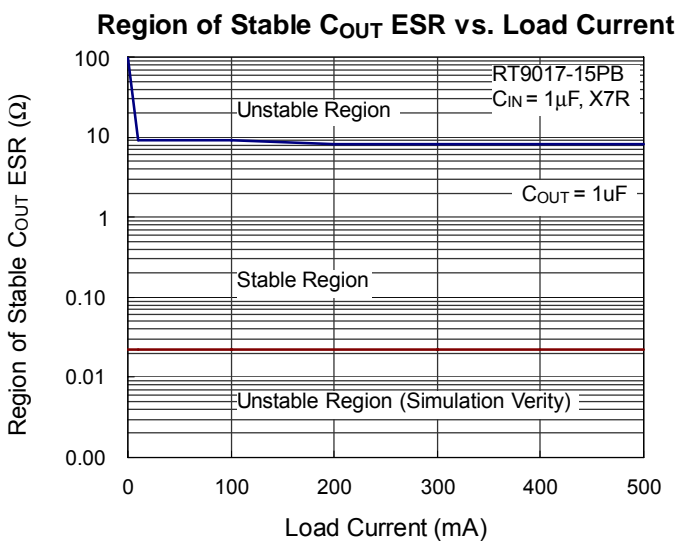

Figure 1

Enable Function

The RT9017 features an LDO regulator enable/disable function. To assure the LDO regulator will switch on, the EN turn on control level must be greater than 1.2 volts. The LDO regulator will go into the shutdown mode when the voltage on the EN pin falls below 0.4 volts. For protecting the system, the RT9017 have a quick-discharge function. If the enable function is not needed in a specific application, it may be tied to V_{IN} to keep the LDO regulator in a continuously on state.

Thermal Considerations

Thermal protection limits power dissipation in RT9017. When the operation junction temperature exceeds 165°C , the OTP circuit starts the thermal shutdown function and turns the pass element off. The pass element turn on again after the junction temperature cools by 30°C .

RT9017 lowers its OTP trip level from 165°C to 110°C when output short circuit occurs ($V_{\text{OUT}} < 0.4\text{V}$) as shown in Figure 2. This limits IC case temperature under 100°C and provides maximum safety to end users when output short circuit occurs.

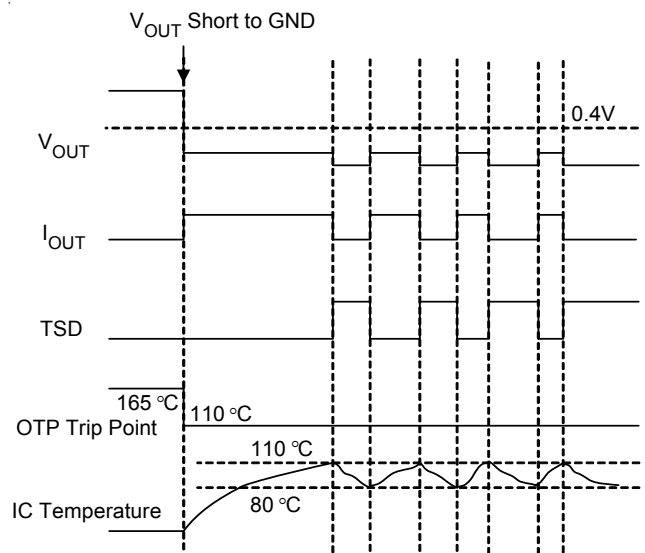

Figure 2. Short Circuit Thermal Folded Back Protection when Output Short Circuit Occurs

For continuous operation, do not exceed absolute maximum operation junction temperature 125°C. The power dissipation definition in device is :

$$P_D = (V_{IN} - V_{OUT}) \times I_{OUT} + V_{IN} \times I_Q$$

The maximum power dissipation depends on the thermal resistance of IC package, PCB layout, the rate of surroundings airflow and temperature difference between junction to ambient. The maximum power dissipation can be calculated by following formula :

$$P_{D(MAX)} = (T_{J(MAX)} - T_A) / \theta_{JA}$$

Where $T_{J(MAX)}$ is the maximum operation junction temperature 125°C, T_A is the ambient temperature and the θ_{JA} is the junction to ambient thermal resistance.

For recommended operating conditions specification of RT9017, where $T_{J(MAX)}$ is the maximum junction temperature of the die (125°C) and T_A is the maximum ambient temperature. The junction to ambient thermal resistance (θ_{JA} is layout dependent) for SOT-23-3/SOT-23-5 package is 250°C/W and WDFN-6L 2x2 package is 165°C/W on standard JEDEC 51-3 thermal test board. The maximum power dissipation at $T_A = 25^\circ\text{C}$ can be calculated by following formula :

$$P_{D(MAX)} = (125^\circ\text{C} - 25^\circ\text{C}) / 250 = 400 \text{ mW (SOT-23-3/SOT-23-5)}$$

$$P_{D(MAX)} = (125^\circ\text{C} - 25^\circ\text{C}) / 333 = 300 \text{ mW (SC-70-5)}$$

The maximum power dissipation depends on operating ambient temperature for fixed $T_{J(MAX)}$ and thermal resistance θ_{JA} . For RT9017 packages, the Figure 3. of derating curves allows the designer to see the effect of rising ambient temperature on the maximum power allowed.

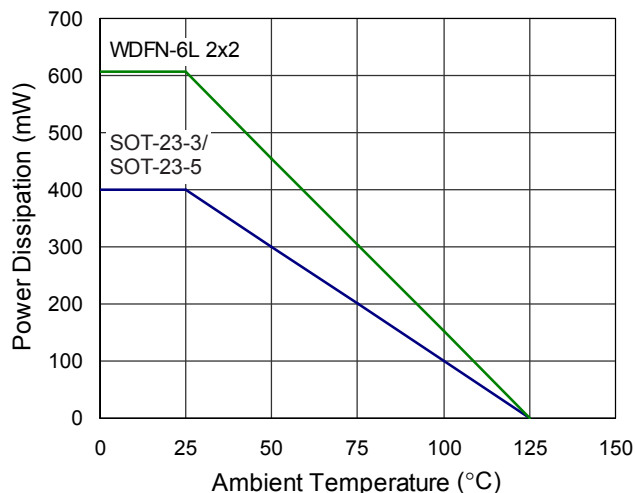
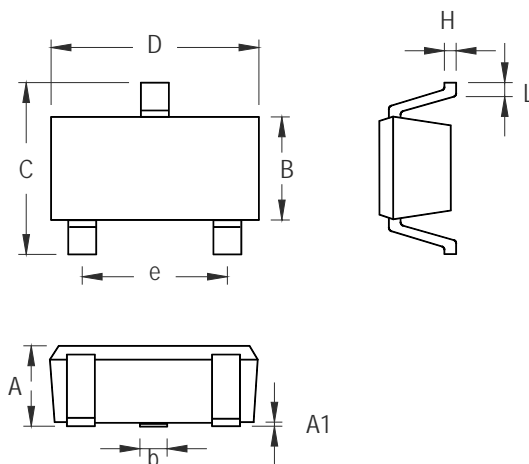

Figure 3. Derating Curve for Packages

Outline Dimension



Symbol	Dimensions In Millimeters		Dimensions In Inches	
	Min	Max	Min	Max
A	0.889	1.295	0.035	0.051
A1	0.000	0.152	0.000	0.006
B	1.397	1.803	0.055	0.071
b	0.356	0.508	0.014	0.020
C	2.591	2.997	0.102	0.118
D	2.692	3.099	0.106	0.122
e	1.803	2.007	0.071	0.079
H	0.080	0.254	0.003	0.010
L	0.300	0.610	0.012	0.024

SOT-23-3 Surface Mount Package

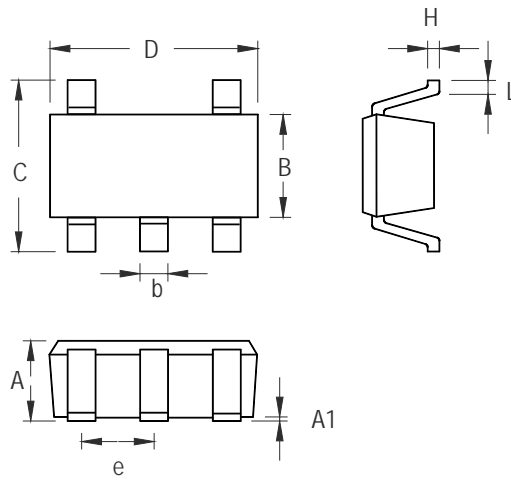

Symbol	Dimensions In Millimeters		Dimensions In Inches	
	Min	Max	Min	Max
A	0.889	1.295	0.035	0.051
A1	0.000	0.152	0.000	0.006
B	1.397	1.803	0.055	0.071
b	0.356	0.559	0.014	0.022
C	2.591	2.997	0.102	0.118
D	2.692	3.099	0.106	0.122
e	0.838	1.041	0.033	0.041
H	0.080	0.254	0.003	0.010
L	0.300	0.610	0.012	0.024

SOT-23-5 Surface Mount Package

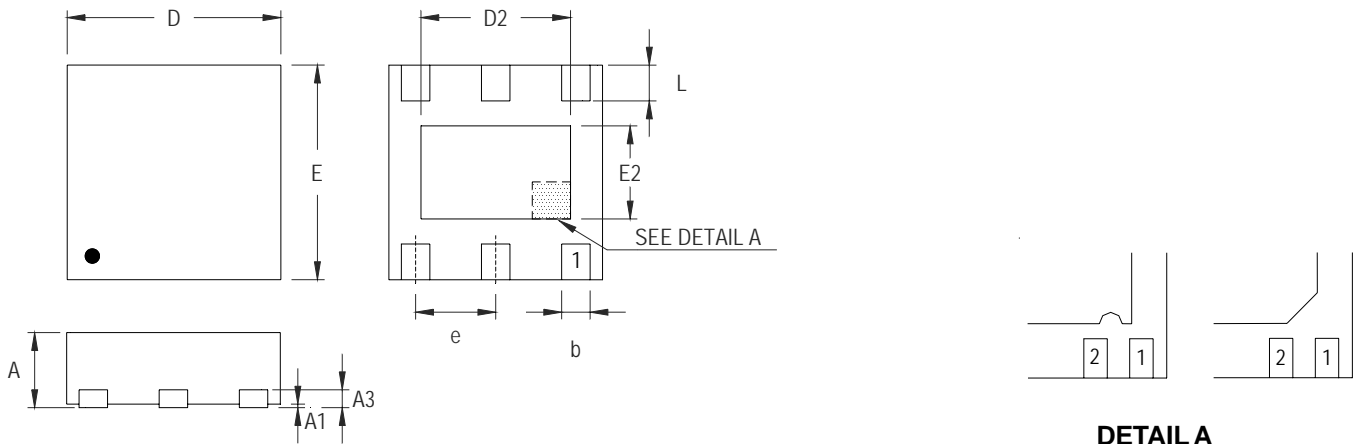

DETAIL A

Pin #1 ID and Tie Bar Mark Options

Note : The configuration of the Pin #1 identifier is optional, but must be located within the zone indicated.

Symbol	Dimensions In Millimeters		Dimensions In Inches	
	Min	Max	Min	Max
A	0.700	0.800	0.028	0.031
A1	0.000	0.050	0.000	0.002
A3	0.175	0.250	0.007	0.010
b	0.200	0.350	0.008	0.014
D	1.950	2.050	0.077	0.081
D2	1.000	1.450	0.039	0.057
E	1.950	2.050	0.077	0.081
E2	0.500	0.850	0.020	0.033
e	0.650		0.026	
L	0.300	0.400	0.012	0.016

W-Type 6L DFN 2x2 Package

Richtek Technology Corporation

Headquarter
 5F, No. 20, Taiyuen Street, Chupei City
 Hsinchu, Taiwan, R.O.C.
 Tel: (8863)5526789 Fax: (8863)5526611

Richtek Technology Corporation

Taipei Office (Marketing)
 5F, No. 95, Minchiuan Road, Hsintien City
 Taipei County, Taiwan, R.O.C.
 Tel: (8862)86672399 Fax: (8862)86672377
 Email: marketing@richtek.com

Information that is provided by Richtek Technology Corporation is believed to be accurate and reliable. Richtek reserves the right to make any change in circuit design, specification or other related things if necessary without notice at any time. No third party intellectual property infringement of the applications should be guaranteed by users when integrating Richtek products into any application. No legal responsibility for any said applications is assumed by Richtek.