

CFL.Spiral 7W

7W B15/B22/E14/E27 Compact Fluorescent Lamp



Product Overview

Kosnic's CFL Spiral lamps have a unique helix structure which allows the fluorescent tube to be twisted into a very compact size, giving enhanced lumen efficiency. The Kosnic CFL Spirals are ideal for general lighting applications, replacing incandescent lamps in demanding domestic and professional settings.

Features

- Compact helix shape.
- Popular B15, B22, E14 and E27 caps.
- Save energy up to 80% compared with filament lamp.
- High lumen output.
- Long life of 10,000h.
- Amalgam mercury.

Safety and Maintenance

- Switch off supply before installing or removing lamp.
- Allow to cool before handling.
- Do not use in totally enclosed fittings as this will reduce lamp life.
- Do not dispose of in household waste.
- Dispose of in appropriate section of local civic amenity site or recycling centre.

Specifications – B15 Cap

Product Code	KCF07SP3/B15-827
Lamp Cap	B15
Lamp Shape	Spiral
Nominal Power (W)	7
Voltage	220-240Vac 50-60Hz
Current (mA)	55
Nominal Luminous Flux (lm)	350
CCT (K)	2700K Warm White
Nominal Lifetime (h)	10000
Dimmable	No
Switching Cycles	12000
Warm-up time to 60% (S)	60
Length (mm)	98
Diameter (mm)	39
Mercury (mg)	2.0
Clean-up instructions	See website
Retrofit	No
Equivalent Wattage (W)	34
Rated Power (W)	7.0
Rated Luminous Flux (lm)	350
Rated Lifetime (h)	10000
Power Factor	0.55
Rated Peak Candelas (cd)	45
Lumen Maintenance Factor at Nominal Lifetime	0.75
CRI	83
Start Time (s)	0.20
Ambient Temperature Range (°C)	-20 to 40

Energy Label – B15 Cap

Manufacturer	Kosnic
Product Code	KCF07SP3/B15-827
Energy Class	A
Energy Consumption (kWh/1000h)	7.00 (7)*

* The kWh/1000h value published on the energy label is required to be rounded up to an integer according to the EU implementing directive on Energy Labelling. The value to 2 decimal places is given for reference.

Product Markings – B15 Cap

Manufacturer	Kosnic
Product Code	KCF07SP3/B15-827
Voltage	220-240Vac 50-60Hz
Nominal Power (W)	7
Current (mA)	55
CE Mark	Yes
WEEE Mark	Yes
Batch Code	Yes

Specifications – B22 Cap

Product Code	KCF07SP3/B22-827	KCF07SP3/B22-840	KCF07SP3/B22-865
Lamp Cap	B22	B22	B22
Lamp Shape	Spiral	Spiral	Spiral
Nominal Power (W)	7	7	7
Voltage	220-240Vac 50-60Hz	220-240Vac 50-60Hz	220-240Vac 50-60Hz
Current (mA)	55	55	55
Nominal Luminous Flux (lm)	350	350	350
CCT (K)	2700K Warm White	4000K Cool White	6500K Day Light
Nominal Lifetime (h)	10000	10000	10000
Dimmable	No	No	No
Switching Cycles	12000	12000	12000
Warm-up time to 60% (S)	60	60	60
Length (mm)	98	98	98
Diameter (mm)	39	39	39
Mercury (mg)	2.0	2.0	2.0
Clean-up instructions	See website	See website	See website
Retrofit	No	No	No
Equivalent Wattage (W)	34	34	34
Rated Power (W)	7.0	7.0	7.0
Rated Luminous Flux (lm)	350	350	350
Rated Lifetime (h)	10000	10000	10000
Power Factor	0.55	0.55	0.55
Rated Peak Candelas (cd)	45	45	45
Lumen Maintenance Factor at Nominal Lifetime	0.75	0.75	0.75
CRI	83	84	82
Start Time (s)	0.20	0.20	0.20
Ambient Temperature Range (°C)	-20 to 40	-20 to 40	-20 to 40

Energy Label – B22 Cap

Manufacturer	Kosnic	Kosnic	Kosnic
Product Code	KCF07SP3/B22-827	KCF07SP3/B22-840	KCF07SP3/B22-865
Energy Class	A	A	A
Energy Consumption (kWh/1000h)	7.00 (7)*	7.00 (7)*	7.00 (7)*

* The kWh/1000h value published on the energy label is required to be rounded up to an integer according to the EU implementing directive on Energy Labelling. The value to 2 decimal places is given for reference.

Product Markings – B22 Cap

Manufacturer	Kosnic	Kosnic	Kosnic
Product Code	KCF07SP3/B22-827	KCF07SP3/B22-840	KCF07SP3/B22-865
Voltage	220-240Vac 50-60Hz	220-240Vac 50-60Hz	220-240Vac 50-60Hz
Nominal Power (W)	7	7	7
Current (mA)	55	55	55
CE Mark	Yes	Yes	Yes
WEEE Mark	Yes	Yes	Yes
Batch Code	Yes	Yes	Yes

Specifications – E14 Cap

Product Code	KCF07SP3/E14-827	KCF07SP3/E14-840	KCF07SP3/E14-865
Lamp Cap	E14	E14	E14
Lamp Shape	Spiral	Spiral	Spiral
Nominal Power (W)	7	7	7
Voltage	220-240Vac 50-60Hz	220-240Vac 50-60Hz	220-240Vac 50-60Hz
Current (mA)	55	55	55
Nominal Luminous Flux (lm)	350	350	350
CCT (K)	2700K Warm White	4000K Cool White	6500K Day Light
Nominal Lifetime (h)	10000	10000	10000
Dimmable	No	No	No
Switching Cycles	12000	12000	12000
Warm-up time to 60% (S)	60	60	60
Length (mm)	98	98	98
Diameter (mm)	39	39	39
Mercury (mg)	2.0	2.0	2.0
Clean-up instructions	See website	See website	See website
Retrofit	No	No	No
Equivalent Wattage (W)	34	34	34
Rated Power (W)	7.0	7.0	7.0
Rated Luminous Flux (lm)	350	350	350
Rated Lifetime (h)	10000	10000	10000
Power Factor	0.55	0.55	0.55
Rated Peak Candelas (cd)	45	45	45
Lumen Maintenance Factor at Nominal Lifetime	0.75	0.75	0.75
CRI	83	84	82
Start Time (s)	0.20	0.20	0.20
Ambient Temperature Range (°C)	-20 to 40	-20 to 40	-20 to 40

Energy Label – E14Cap

Manufacturer	Kosnic	Kosnic	Kosnic
Product Code	KCF07SP3/E14-827	KCF07SP3/E14-840	KCF07SP3/E14-865
Energy Class	A	A	A
Energy Consumption (kWh/1000h)	7.00 (7)*	7.00 (7)*	7.00 (7)*

* The kWh/1000h value published on the energy label is required to be rounded up to an integer according to the EU implementing directive on Energy Labelling. The value to 2 decimal places is given for reference.

Product Markings – E14Cap

Manufacturer	Kosnic	Kosnic	Kosnic
Product Code	KCF07SP3/E14-827	KCF07SP3/E14-840	KCF07SP3/E14-865
Voltage	220-240Vac 50-60Hz	220-240Vac 50-60Hz	220-240Vac 50-60Hz
Nominal Power (W)	7	7	7
Current (mA)	55	55	55
CE Mark	Yes	Yes	Yes
WEEE Mark	Yes	Yes	Yes
Batch Code	Yes	Yes	Yes

Specifications – E27 Cap

Product Code	KCF07SP3/E27-827	KCF07SP3/E27-840	KCF07SP3/E27-865
Lamp Cap	E27	E27	E27
Lamp Shape	Spiral	Spiral	Spiral
Nominal Power (W)	7	7	7
Voltage	220-240Vac 50-60Hz	220-240Vac 50-60Hz	220-240Vac 50-60Hz
Current (mA)	55	55	55
Nominal Luminous Flux (lm)	350	350	350
CCT (K)	2700K Warm White	4000K Cool White	6500K Day Light
Nominal Lifetime (h)	10000	10000	10000
Dimmable	No	No	No
Switching Cycles	12000	12000	12000
Warm-up time to 60% (S)	60	60	60
Length (mm)	98	98	98
Diameter (mm)	39	39	39
Mercury (mg)	2.0	2.0	2.0
Clean-up instructions	See website	See website	See website
Retrofit	No	No	No
Equivalent Wattage (W)	34	34	34
Rated Power (W)	7.0	7.0	7.0
Rated Luminous Flux (lm)	350	350	350
Rated Lifetime (h)	10000	10000	10000
Power Factor	0.55	0.55	0.55
Rated Peak Candelas (cd)	45	45	45
Lumen Maintenance Factor at Nominal Lifetime	0.75	0.75	0.75
CRI	83	84	82
Start Time (s)	0.20	0.20	0.20
Ambient Temperature Range (°C)	-20 to 40	-20 to 40	-20 to 40

Energy Label – E27Cap

Manufacturer	Kosnic	Kosnic	Kosnic
Product Code	KCF07SP3/E27-827	KCF07SP3/E27-840	KCF07SP3/E27-865
Energy Class	A	A	A
Energy Consumption (kWh/1000h)	7.00 (7)*	7.00 (7)*	7.00 (7)*

* The kWh/1000h value published on the energy label is required to be rounded up to an integer according to the EU implementing directive on Energy Labelling. The value to 2 decimal places is given for reference.

Product Markings – E27Cap

Manufacturer	Kosnic	Kosnic	Kosnic
Product Code	KCF07SP3/E27-827	KCF07SP3/E27-840	KCF07SP3/E27-865
Voltage	220-240Vac 50-60Hz	220-240Vac 50-60Hz	220-240Vac 50-60Hz
Nominal Power (W)	7	7	7
Current (mA)	55	55	55
CE Mark	Yes	Yes	Yes
WEEE Mark	Yes	Yes	Yes
Batch Code	Yes	Yes	Yes

Dimensions

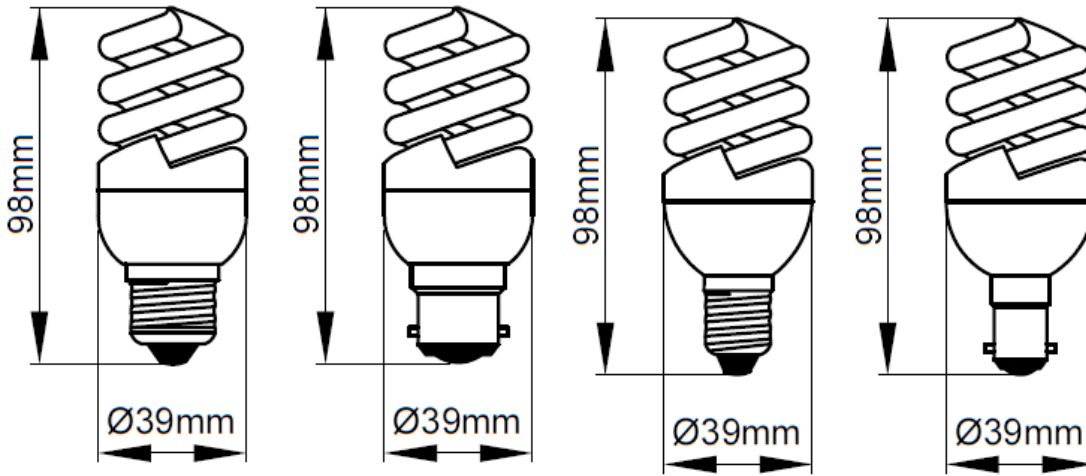

KCF07SP3/E27 KCF07SP3/B22 KCF07SP3/E14 KCF07SP3/B15

Photometric Information

2700K

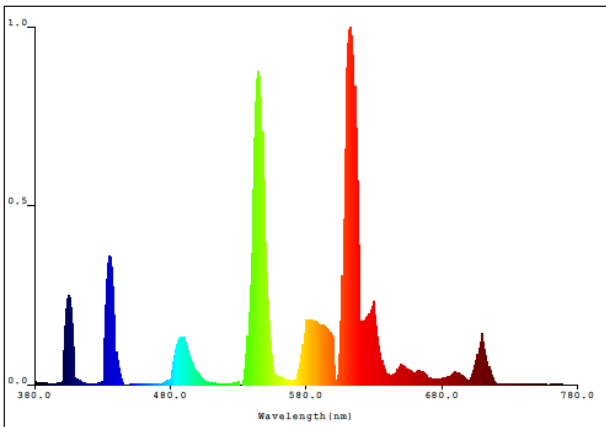

4000K

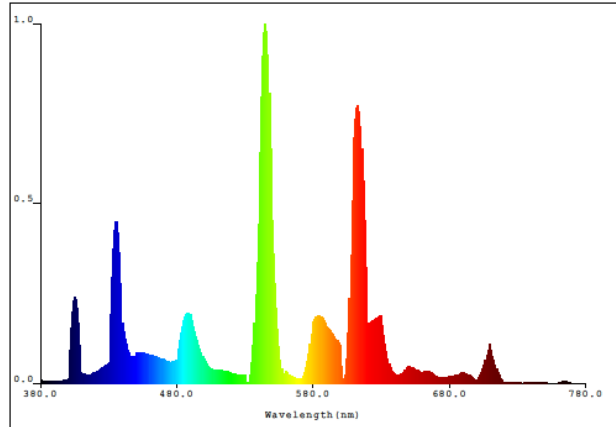

6500K

