

## FEATURES

- Low noise: 18  $\mu\text{V rms}$
- Power supply rejection ratio (PSRR): 66 dB at 10 kHz at  $V_{\text{OUT}} = -3\text{ V}$
- Positive or negative enable logic
- Stable with small 2.2  $\mu\text{F}$  ceramic output capacitor
- Input voltage range: -2.7 V to -28 V
- Maximum output current: -200 mA
- Low dropout voltage: -185 mV at -200 mA load
- Initial accuracy:  $\pm 1\%$
- Accuracy over line, load, and temperature  
+2% maximum/-3% minimum
- Low quiescent current,  $I_{\text{GND}} = -650\ \mu\text{A}$  with -200 mA load
- Low shutdown current: -2  $\mu\text{A}$
- Adjustable output from -1.22 V to  $-V_{\text{IN}} + V_{\text{DO}}$
- Current-limit and thermal overload protection
- 8-lead LFCSP and 5-lead TSOT

## APPLICATIONS

- Regulation to noise sensitive applications
  - Analog-to-digital converter (ADC) and digital-to-analog converter (DAC) circuits, precision amplifiers
- Communications and infrastructure
- Medical and healthcare
- Industrial and instrumentation

## GENERAL DESCRIPTION

The ADP7182 is a CMOS, low dropout (LDO) linear regulator that operates from -2.7 V to -28 V and provides up to -200 mA of output current. This high input voltage LDO is ideal for regulation of high performance analog and mixed signal circuits operating from -27 V down to -1.22 V rails. Using an advanced proprietary architecture, it provides high power supply rejection and low noise, and achieves excellent line and load transient response with a small 2.2  $\mu\text{F}$  ceramic output capacitor.

## TYPICAL APPLICATION CIRCUITS

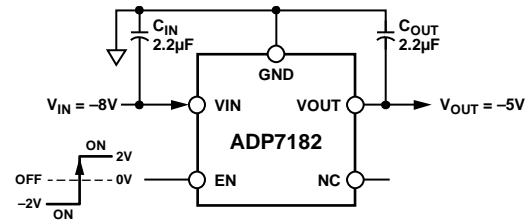

Figure 1. ADP7182 with Fixed Output Voltage,  $V_{\text{OUT}} = -5\text{ V}$

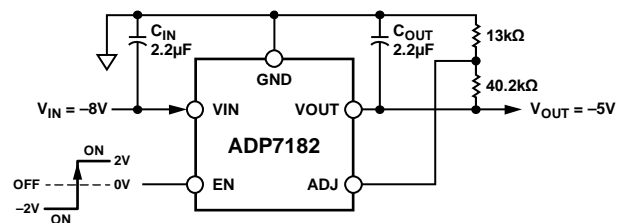

Figure 2. ADP7182 with Adjustable Output Voltage,  $V_{\text{OUT}} = -5\text{ V}$

The ADP7182 is available in a fixed output voltage and an adjustable version that allows the output voltage to range from -1.22 V to  $-V_{\text{IN}} + V_{\text{DO}}$  via an external feedback divider.

The ADP7182 regulator output noise is 18  $\mu\text{V rms}$  independent of the output voltage. The enable logic is capable of interfacing with positive or negative logic levels for maximum flexibility.

The ADP7182 is available in 5-lead TSOT and 8-lead LFCSP packages for a small, low profile footprint.

## TABLE OF CONTENTS

Features .....	1	Theory of Operation .....	20
Applications.....	1	Enable Pin Operation .....	20
Typical Application Circuits.....	1	Adjustable Mode Operation .....	20
General Description .....	1	Applications Information .....	21
Revision History .....	2	ADIsimPower Design Tool .....	21
Specifications.....	3	Capacitor Selection .....	21
Input and Output Capacitance, Recommended		Enable Pin Operation .....	22
Specifications .....	4	Soft Start .....	22
Absolute Maximum Ratings.....	5	Noise Reduction of the Adjustable ADP7182 .....	23
Thermal Data .....	5	Current-Limit and Thermal Overload Protection.....	23
Thermal Resistance .....	5	Thermal Considerations.....	24
ESD Caution.....	5	PCB Layout Considerations.....	26
Pin Configurations and Function Descriptions .....	6	Outline Dimensions .....	27
Typical Performance Characteristics .....	8	Ordering Guide .....	28

## REVISION HISTORY

### 9/13—Rev. B to Rev. C

Changes to Ordering Guide .....	28
---------------------------------	----

### 6/13—Rev. A to Rev. B

Changes to General Description .....	1
Updated Outline Dimensions .....	27
Changes to Ordering Guide .....	28

### 5/13—Rev. 0 to Rev. A

Changed Start-Up Time $V_{OUT} = -5\text{ V}$ from 450 $\mu\text{s}$ to 550 $\mu\text{s}$ .....	3
Changes to Figure 9 and Figure 12.....	8
Changes to Figure 13.....	9
Changes to Figure 19 and Figure 22.....	10
Changes to Figure 28.....	11
Changes to Figure 31 and Figure 34.....	12
Changes to Figure 37 and Figure 40.....	13
Changes to Figure 43.....	14
Added ADIsimPower Design Tool Section.....	21

### 4/13—Revision 0: Initial Version

## SPECIFICATIONS

$V_{IN} = (V_{OUT} - 0.5 V)$  or  $-2.7 V$  (whichever is greater),  $EN = V_{IN}$ ,  $I_{OUT} = -10 mA$ ,  $C_{IN} = C_{OUT} = 2.2 \mu F$ ,  $T_J = -40^\circ C$  to  $+125^\circ C$  for minimum/maximum specifications,  $T_A = 25^\circ C$  for typical specifications, unless otherwise noted.

Table 1.

Parameter	Symbol	Test Conditions/Comments	Min	Typ	Max	Unit
INPUT VOLTAGE RANGE	$V_{IN}$		-2.7		-28	V
OPERATING SUPPLY CURRENT	$I_{GND}$	$I_{OUT} = 0 \mu A$ $I_{OUT} = -10 mA$ $I_{OUT} = -200 mA$		-33 -100 -650	-53 -150 -850	$\mu A$ $\mu A$ $\mu A$
SHUTDOWN CURRENT	$I_{GND-SD}$	$EN = GND$ $EN = GND, V_{IN} = -2.7 V$ to $-28 V$		-2	-8	$\mu A$ $\mu A$
OUTPUT VOLTAGE ACCURACY						
Fixed Output Voltage Accuracy	$V_{OUT}$	$I_{OUT} = -10 mA, T_A = 25^\circ C$ $-1 mA < I_{OUT} < -200 mA, V_{IN} = (V_{OUT} - 0.5 V)$ to $-28 V$	-1 -3		+1 +2	% %
Adjustable Output Voltage Accuracy	$V_{ADJ}$	$I_{OUT} = -10 mA$ $-1 mA < I_{OUT} < -200 mA, V_{IN} = (V_{OUT} - 0.5 V)$ to $-28 V$	-1.208 -1.184	-1.22	-1.232 -1.244	V V
LINE REGULATION	$\Delta V_{OUT}/\Delta V_{IN}$	$V_{IN} = (V_{OUT} - 0.5 V)$ to $-28 V$	-0.01		+0.01	%/V
LOAD REGULATION <sup>1</sup>	$\Delta V_{OUT}/\Delta I_{OUT}$	$I_{OUT} = -1 mA$ to $-200 mA$		0.001	0.006	%/mA
ADJ INPUT BIAS CURRENT	$ADJ_{I-BIAS}$	$-1 mA < I_{OUT} < -200 mA, V_{IN} = (V_{OUT} - 0.5 V)$ to $-28 V$		10		nA
DROPOUT VOLTAGE <sup>2</sup>	$V_{DO}$	$I_{OUT} = -10 mA$ $I_{OUT} = -50 mA$ $I_{OUT} = -200 mA$		-25 -46 -185	-70 -90 -360	mV mV mV
START-UP TIME <sup>3</sup>	$t_{START-UP}$	$V_{OUT} = -5 V$ $V_{OUT} = -2.8 V$		550 375		$\mu s$ $\mu s$
CURRENT-LIMIT THRESHOLD <sup>4</sup>	$I_{LIMIT}$		-230	-350	-500	mA
THERMAL SHUTDOWN						
Thermal Shutdown Threshold	$TS_{SD}$	$T_J$ rising		150		$^\circ C$
Thermal Shutdown Hysteresis	$TS_{SD-HYS}$			15		$^\circ C$
ENTHRESHOLD						
Positive Rise	$V_{EN-POS-RISE}$	$V_{OUT} = \text{off to on (positive)}$			1.2	V
Negative Rise	$V_{EN-NEG-RISE}$	$V_{OUT} = \text{off to on (negative)}$	-2.0			V
Positive Fall	$V_{EN-POS-FALL}$	$V_{OUT} = \text{on to off (positive)}$	0.3			V
Negative Fall	$V_{EN-NEG-FALL}$	$V_{OUT} = \text{on to off (negative)}$			-0.55	V
INPUT VOLTAGE LOCKOUT						
Start Threshold	$V_{START}$		-2.695	-2.49		V
Shutdown Threshold	$V_{SHUTDOWN}$			-2.34	-2.1	V
Hysteresis				150		mV
OUTPUT NOISE	$OUT_{NOISE}$	10 Hz to 100 kHz, $V_{OUT} = -1.5 V, V_{OUT} = -3 V$ , and $V_{OUT} = -5 V$ 10 Hz to 100 kHz, $V_{OUT} = -5 V$ , adjustable mode, $C_{NR} = \text{open}, R_{NR} = \text{open}, R_{FB1} = 147 k\Omega, R_{FB2} = 13 k\Omega$ 10 Hz to 100 kHz, $V_{OUT} = -5 V$ , adjustable mode, $C_{NR} = 100 nF, R_{NR} = 13 k\Omega, R_{FB1} = 147 k\Omega, R_{FB2} = 13 k\Omega$		18 150 33		$\mu V$ rms $\mu V$ rms $\mu V$ rms

Parameter	Symbol	Test Conditions/Comments	Min	Typ	Max	Unit
POWER SUPPLY REJECTION RATIO	PSRR	1 MHz, $V_{IN} = -4.3\text{ V}$ , $V_{OUT} = -3\text{ V}$		45		dB
		1 MHz, $V_{IN} = -6\text{ V}$ , $V_{OUT} = -5\text{ V}$		32		dB
		100 kHz, $V_{IN} = -4.3\text{ V}$ , $V_{OUT} = -3\text{ V}$		45		dB
		100 kHz, $V_{IN} = -6\text{ V}$ , $V_{OUT} = -5\text{ V}$		45		dB
		10 kHz, $V_{IN} = -4.3\text{ V}$ , $V_{OUT} = -3\text{ V}$		66		dB
		10 kHz, $V_{IN} = -6\text{ V}$ , $V_{OUT} = -5\text{ V}$		66		dB
		1 MHz, $V_{IN} = -16\text{ V}$ , $V_{OUT} = -15\text{ V}$ , adjustable mode, $C_{NR} = 100\text{ nF}$ , $R_{NR} = 13\text{ k}\Omega$ , $R_{FB1} = 13\text{ k}\Omega$ , $R_{FB2} = 147\text{ k}\Omega$		45		dB
		100 kHz, $V_{IN} = -16\text{ V}$ , $V_{OUT} = -15\text{ V}$ , adjustable mode, $C_{NR} = 100\text{ nF}$ , $R_{NR} = 13\text{ k}\Omega$ , $R_{FB1} = 13\text{ k}\Omega$ , $R_{FB2} = 147\text{ k}\Omega$		45		dB
		10 kHz, $V_{IN} = -16\text{ V}$ , $V_{OUT} = -15\text{ V}$ , adjustable mode, $C_{NR} = 100\text{ nF}$ , $R_{NR} = 13\text{ k}\Omega$ , $R_{FB1} = 13\text{ k}\Omega$ , $R_{FB2} = 147\text{ k}\Omega$		66		dB
		10 kHz, $V_{IN} = -16\text{ V}$ , $V_{OUT} = -15\text{ V}$ , adjustable mode, $C_{NR} = 100\text{ nF}$ , $R_{NR} = 13\text{ k}\Omega$ , $R_{FB1} = 13\text{ k}\Omega$ , $R_{FB2} = 147\text{ k}\Omega$		66		dB

<sup>1</sup> Based on an endpoint calculation using  $-1\text{ mA}$  and  $-200\text{ mA}$  loads. See Figure 8 for the typical load regulation performance for loads less than  $1\text{ mA}$ .

<sup>2</sup> Dropout voltage is defined as the input-to-output voltage differential when the input voltage is set to the nominal output voltage. This applies only for output voltages below  $-3\text{ V}$ .

<sup>3</sup> Start-up time is defined as the time between the rising edge of EN to VOUT being at 90% of its nominal value.

<sup>4</sup> Current-limit threshold is defined as the current at which the output voltage drops to 90% of the specified typical value. For example, the current limit for a  $-5\text{ V}$  output voltage is defined as the current that causes the output voltage to drop to 90% of  $-5\text{ V}$ , or  $-4.5\text{ V}$ .

## INPUT AND OUTPUT CAPACITANCE, RECOMMENDED SPECIFICATIONS

Table 2.

Parameter	Symbol	Test Conditions/Comments	Min	Typ	Max	Unit
INPUT AND OUTPUT CAPACITANCE						
Minimum Capacitance <sup>1</sup>	$C_{MIN}$	$T_A = -40^\circ\text{C}$ to $+125^\circ\text{C}$	1.5	2.2		$\mu\text{F}$
Capacitor Effective Series Resistance (ESR)	$R_{ESR}$	$T_A = -40^\circ\text{C}$ to $+125^\circ\text{C}$	0.001		0.2	$\Omega$

<sup>1</sup> The minimum input and output capacitance must be greater than  $1.5\text{ }\mu\text{F}$  over the full range of operating conditions. The full range of operating conditions in the application must be considered during device selection to ensure that the minimum capacitance specification is met. X7R and X5R type capacitors are recommended; Y5V and Z5U capacitors are not recommended for use with any LDO.

## ABSOLUTE MAXIMUM RATINGS

Table 3.

Parameter	Rating
VIN to GND	+0.3 V to -30 V
VOUT to GND	0.3 V to VIN
EN to GND	5 V to VIN
EN to VIN	+30 V to -0.3 V
ADJ to GND	+0.3 V to VOUT
Storage Temperature Range	-65°C to +150°C
Operating Junction Temperature Range	-40°C to +125°C
Operating Ambient Temperature Range	-40°C to +85°C
Soldering Conditions	JEDEC J-STD-020

Stresses above those listed under Absolute Maximum Ratings may cause permanent damage to the device. This is a stress rating only; functional operation of the device at these or any other conditions above those indicated in the operational section of this specification is not implied. Exposure to absolute maximum rating conditions for extended periods may affect device reliability.

### THERMAL DATA

Absolute maximum ratings apply individually only, not in combination. The ADP7182 can be damaged when the junction temperature limits are exceeded. Monitoring ambient temperature does not guarantee that junction temperature ( $T_J$ ) is within the specified temperature limits. In applications with high power dissipation and poor thermal resistance, the maximum ambient temperature may have to be derated.

In applications with moderate power dissipation and low printed circuit board (PCB) thermal resistance, the maximum ambient temperature can exceed the maximum limit as long as the junction temperature is within specification limits. The  $T_J$  of the device is dependent on the ambient temperature ( $T_A$ ), the power dissipation of the device ( $P_D$ ), and the junction-to-ambient thermal resistance of the package ( $\theta_{JA}$ ).

Maximum  $T_J$  is calculated from the  $T_A$  and  $P_D$  using the formula

$$T_J = T_A + (P_D \times \theta_{JA})$$

Junction-to-ambient thermal resistance ( $\theta_{JA}$ ) of the package is based on modeling and calculation using a 4-layer board. The junction-to-ambient thermal resistance is highly dependent on the application and board layout. In applications where high maximum power dissipation exists, close attention to thermal

board design is required. The value of  $\theta_{JA}$  may vary, depending on PCB material, layout, and environmental conditions. The specified values of  $\theta_{JA}$  are based on a 4-layer, 4 in.  $\times$  3 in. circuit board. See JESD51-7 and JESD51-9 for detailed information on the board construction. For additional information, see the [AN-617 Application Note](#), *MicroCSP™ Wafer Level Chip Scale Package*.

$\Psi_{JB}$  is the junction-to-board thermal characterization parameter with units of °C/W.  $\Psi_{JB}$  of the package is based on modeling and calculation using a 4-layer board. The JESD51-12, *Guidelines for Reporting and Using Electronic Package Thermal Information*, states that thermal characterization parameters are not the same as thermal resistances.  $\Psi_{JB}$  measures the component power flowing through multiple thermal paths rather than a single path as in thermal resistance,  $\theta_{JB}$ . Therefore,  $\Psi_{JB}$  thermal paths include convection from the top of the package as well as radiation from the package, factors that make  $\Psi_{JB}$  more useful in real-world applications. Maximum junction temperature is calculated from the board temperature ( $T_B$ ) and power dissipation using the formula

$$T_J = T_B + (P_D \times \Psi_{JB})$$

See JESD51-8 and JESD51-12 for more detailed information about  $\Psi_{JB}$ .

### THERMAL RESISTANCE

$\theta_{JA}$ ,  $\theta_{JC}$ , and  $\Psi_{JB}$  are specified for the worst-case conditions, that is, a device soldered in a circuit board for surface-mount packages.

Table 4. Thermal Resistance

Package Type	$\theta_{JA}$	$\theta_{JC}$	$\Psi_{JB}$	Unit
8-Lead LFCSP	50.2	31.7	18.2	°C/W
5-Lead TSOT	170	Not applicable	43	°C/W

### ESD CAUTION



**ESD (electrostatic discharge) sensitive device.** Charged devices and circuit boards can discharge without detection. Although this product features patented or proprietary protection circuitry, damage may occur on devices subjected to high energy ESD. Therefore, proper ESD precautions should be taken to avoid performance degradation or loss of functionality.

**PIN CONFIGURATIONS AND FUNCTION DESCRIPTIONS**

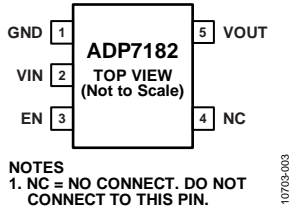

Figure 3. 5-Lead TSOT Pin Configuration, Fixed Output Voltage

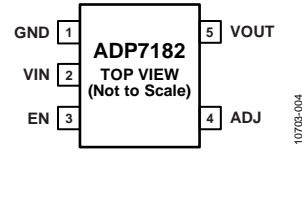
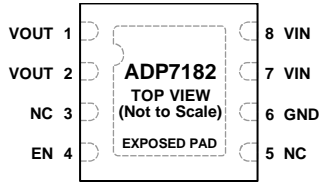

Figure 4. 5-Lead TSOT Pin Configuration, Adjustable Output Voltage

Table 5. 5-Lead TSOT Pin Function Descriptions

TSOT Pin No.		Mnemonic	Description
Fixed Output Voltage	Adjustable Output Voltage		
1	1	GND	Ground.
2	2	VIN	Regulator Input Supply. Bypass VIN to GND with a 2.2 μF or greater capacitor.
3	3	EN	Drive EN 2 V above or below ground to enable the regulator, or drive EN to ground to turn off the regulator. For automatic startup, connect EN to VIN.
4	Not applicable	NC	No Connect. Do not connect to this pin.
Not applicable	4	ADJ	Adjustable Input. An external resistor divider sets the output voltage.
5	5	VOUT	Regulated Output Voltage. Bypass VOUT to GND with a 2.2 μF or greater capacitor.



**NOTES**  
 1. NC = NO CONNECT. DO NOT CONNECT TO THIS PIN.  
 2. THE EXPOSED PAD ON THE BOTTOM OF THE LFCSP PACKAGE ENHANCES THERMAL PERFORMANCE AND IS ELECTRICALLY CONNECTED TO VIN INSIDE THE PACKAGE. THE EXPOSED PAD MUST BE CONNECTED TO THE VIN PLANE ON THE BOARD FOR PROPER OPERATION. BECAUSE THIS IS A NEGATIVE VOLTAGE REGULATOR, VIN IS THE MOST NEGATIVE POTENTIAL IN THE CIRCUIT.

Figure 5. 8-Lead LFCSP Pin Configuration, Fixed Output Voltage

10703-005

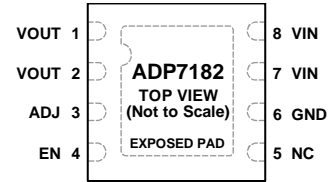

**NOTES**  
 1. NC = NO CONNECT. DO NOT CONNECT TO THIS PIN.  
 2. THE EXPOSED PAD ON THE BOTTOM OF THE LFCSP PACKAGE ENHANCES THERMAL PERFORMANCE AND IS ELECTRICALLY CONNECTED TO VIN INSIDE THE PACKAGE. THE EXPOSED PAD MUST BE CONNECTED TO THE VIN PLANE ON THE BOARD FOR PROPER OPERATION. BECAUSE THIS IS A NEGATIVE VOLTAGE REGULATOR, VIN IS THE MOST NEGATIVE POTENTIAL IN THE CIRCUIT.

Figure 6. 8-Lead LFCSP Pin Configuration, Adjustable Output Voltage

10703-006

Table 6. 8-Lead LFCSP Pin Function Descriptions

LFCSP Pin No.		Mnemonic	Description
Fixed Output Voltage	Adjustable Output Voltage		
1, 2	1, 2	VOUT	Regulated Output Voltage. Bypass VOUT to GND with a 2.2 $\mu$ F or greater capacitor.
Not applicable	3	ADJ	Adjustable Input. An external resistor divider sets the output voltage.
3	Not applicable	NC	No Connect. Do not connect to this pin.
4	4	EN	Drive EN 2 V above or below ground to enable the regulator, or drive EN to ground to turn off the regulator. For automatic startup, connect EN to VIN.
5	5	NC	No Connect. Do not connect to this pin.
6	6	GND	Ground.
7, 8	7, 8	VIN	Regulator Input Supply. Bypass VIN to GND with a 2.2 $\mu$ F or greater capacitor.
9	9	EPAD	Exposed pad. The exposed pad on the bottom of the LFCSP package enhances thermal performance and is electrically connected to VIN inside the package. The exposed pad must be connected to the VIN plane on the board for proper operation. Because this is a negative voltage regulator, VIN is the most negative potential in the circuit.

# TYPICAL PERFORMANCE CHARACTERISTICS

$V_{IN} = -3.5\text{ V}$ ,  $V_{OUT} = -3\text{ V}$ ,  $I_{OUT} = -10\text{ mA}$ ,  $C_{IN} = C_{OUT} = 2.2\text{ }\mu\text{F}$ ,  $T_A = 25^\circ\text{C}$ , unless otherwise noted.

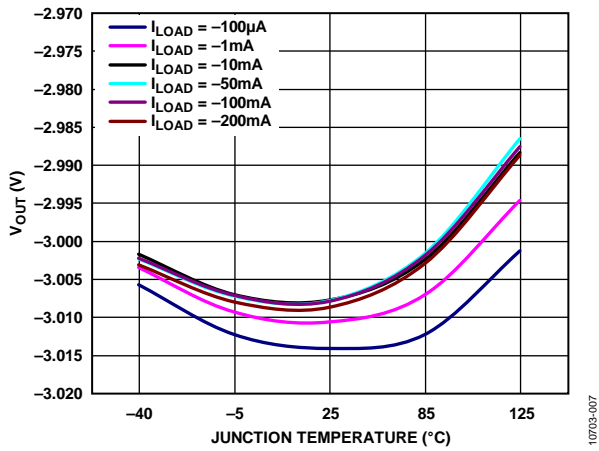

Figure 7. Output Voltage ( $V_{OUT}$ ) vs. Junction Temperature ( $T_J$ )

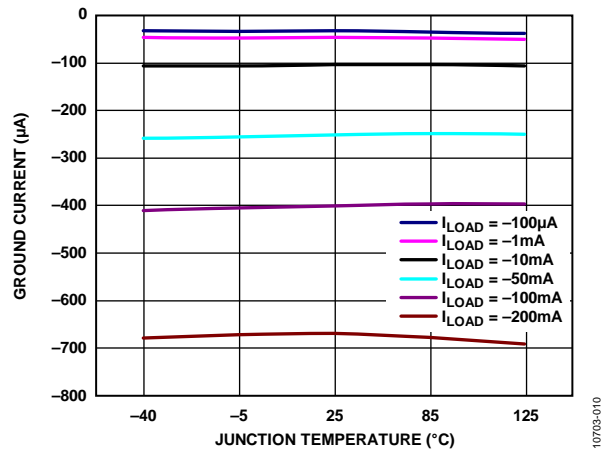

Figure 10. Ground Current vs. Junction Temperature ( $T_J$ )

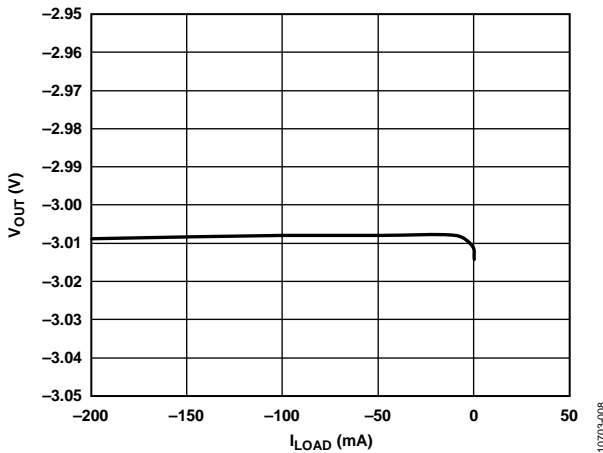

Figure 8. Output Voltage ( $V_{OUT}$ ) vs. Load Current ( $I_{LOAD}$ )

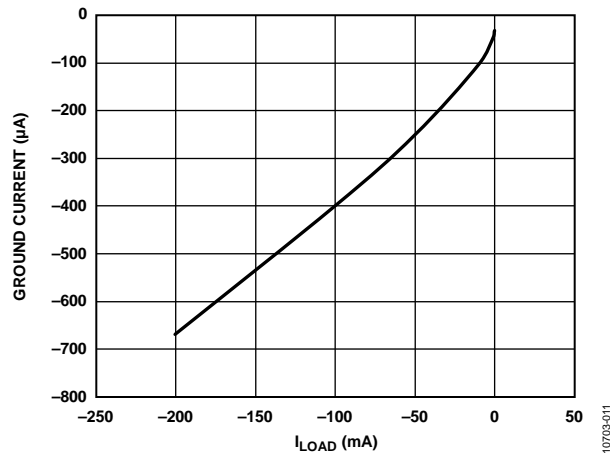

Figure 11. Ground Current vs. Load Current ( $I_{LOAD}$ )

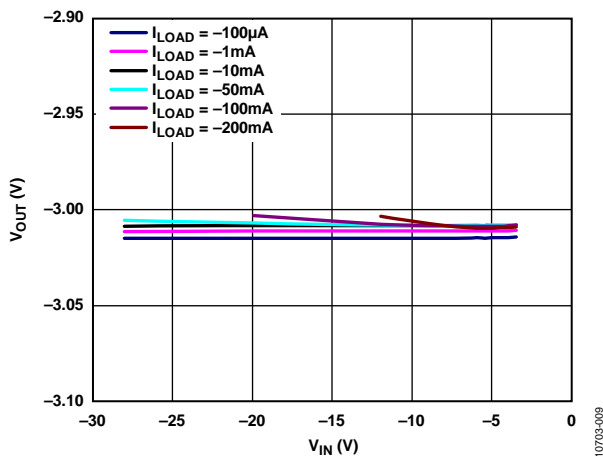

Figure 9. Output Voltage ( $V_{OUT}$ ) vs. Input Voltage ( $V_{IN}$ )

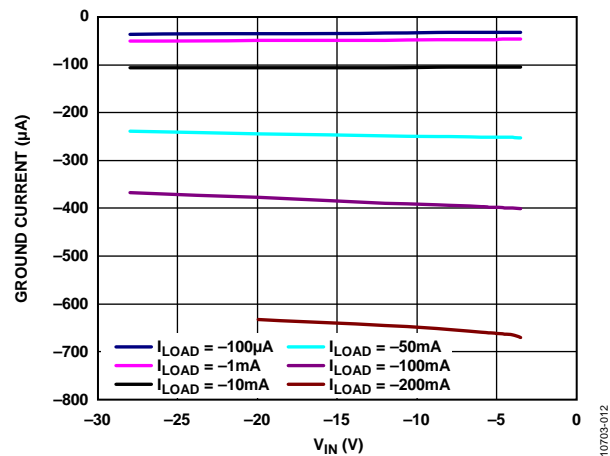

Figure 12. Ground Current vs. Input Voltage ( $V_{IN}$ )



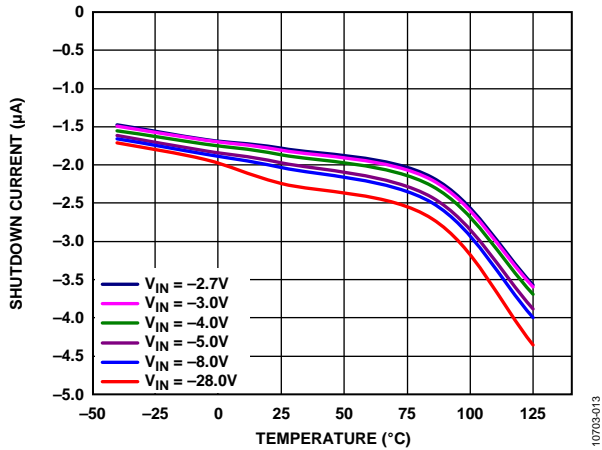

Figure 13. Shutdown Current vs. Temperature at Various Input Voltages

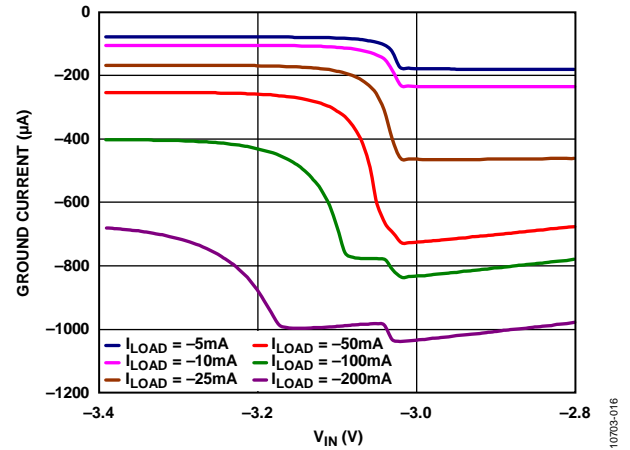

Figure 16. Ground Current vs. Input Voltage ( $V_{IN}$ ) in Dropout

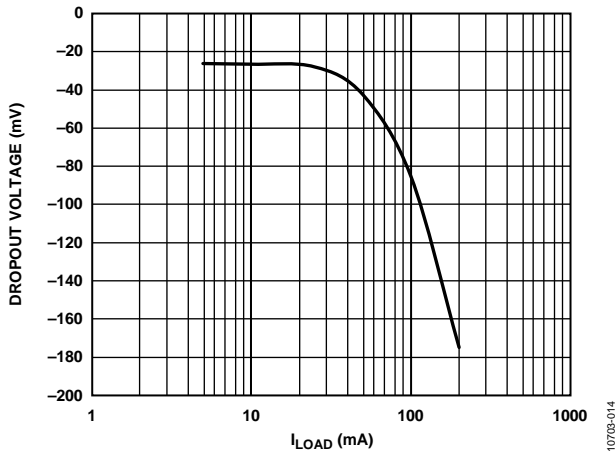

Figure 14. Dropout Voltage vs. Load Current ( $I_{LOAD}$ )

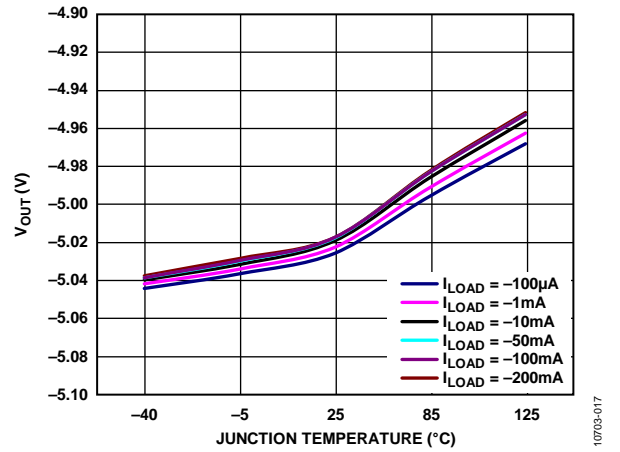

Figure 17. Output Voltage ( $V_{OUT}$ ) vs. Junction Temperature ( $T_J$ ),  $V_{OUT} = -5 V$

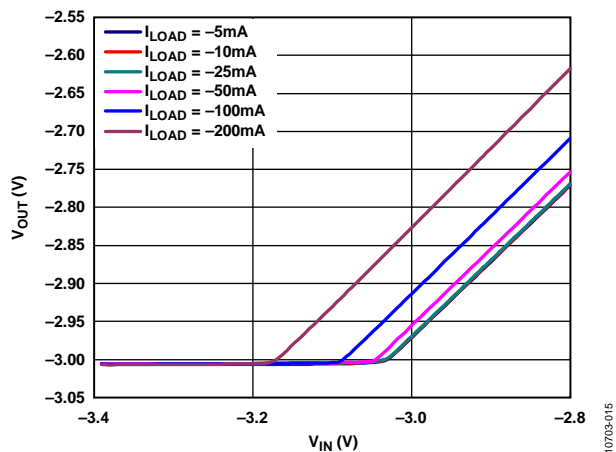

Figure 15. Output Voltage ( $V_{OUT}$ ) vs. Input Voltage ( $V_{IN}$ ) in Dropout

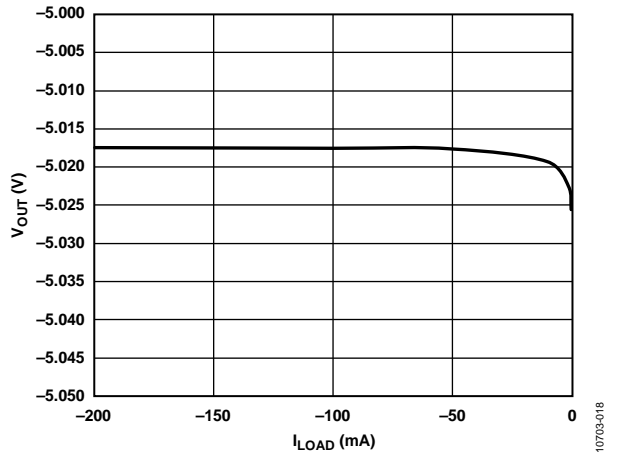

Figure 18. Output Voltage ( $V_{OUT}$ ) vs. Load Current ( $I_{LOAD}$ ),  $V_{OUT} = -5 V$

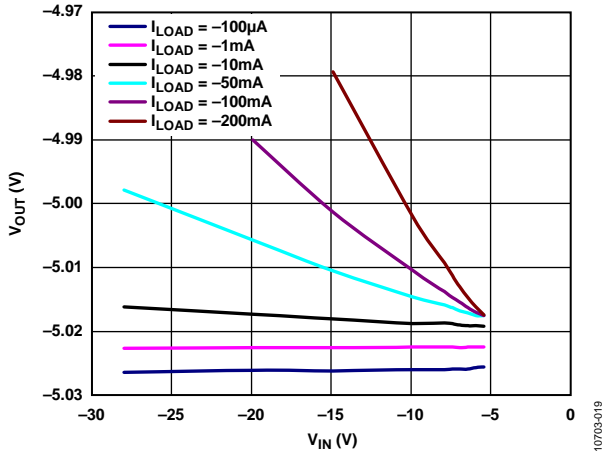

Figure 19. Output Voltage vs. Input Voltage ( $V_{IN}$ ),  $V_{OUT} = -5\text{ V}$

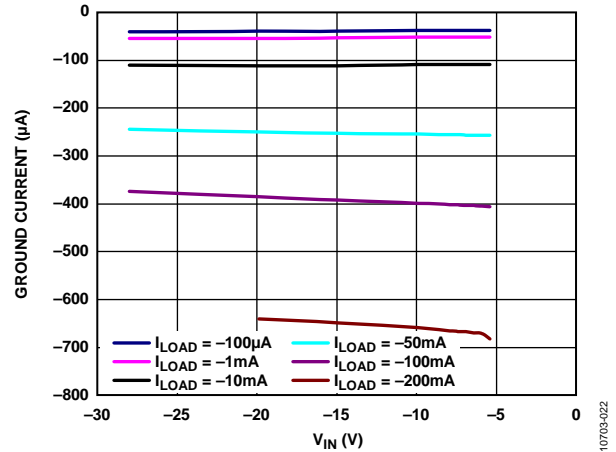

Figure 22. Ground Current vs. Input Voltage ( $V_{IN}$ ),  $V_{OUT} = -5\text{ V}$

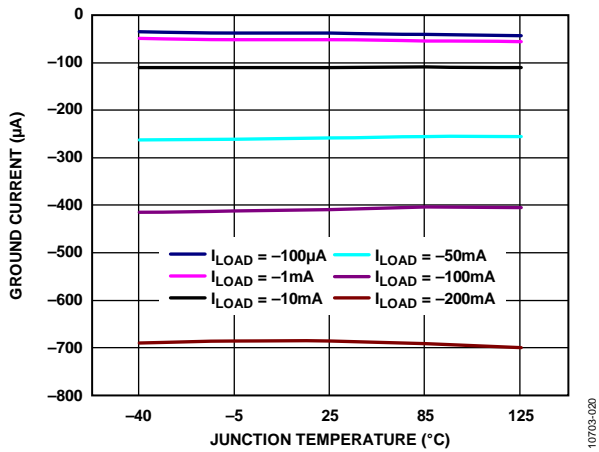

Figure 20. Ground Current vs. Junction Temperature ( $T_j$ ),  $V_{OUT} = -5\text{ V}$

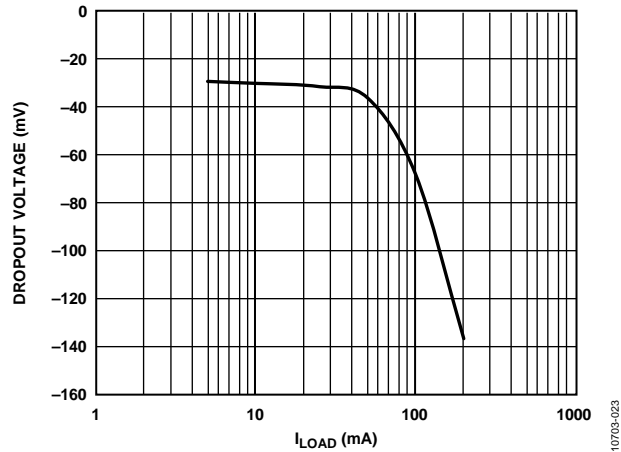

Figure 23. Dropout Voltage vs. Load Current ( $I_{LOAD}$ ),  $V_{OUT} = -5\text{ V}$

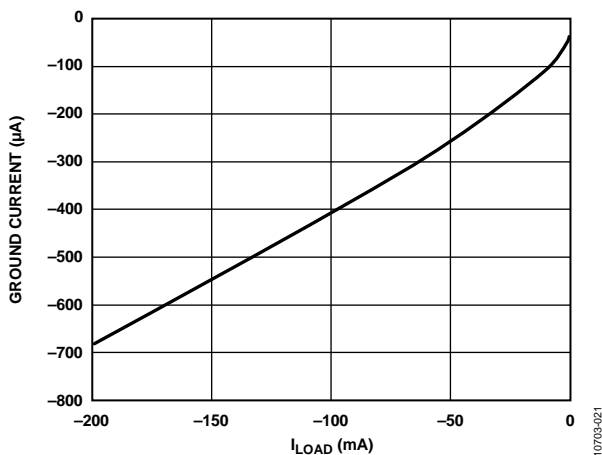

Figure 21. Ground Current vs. Load Current ( $I_{LOAD}$ ),  $V_{OUT} = -5\text{ V}$

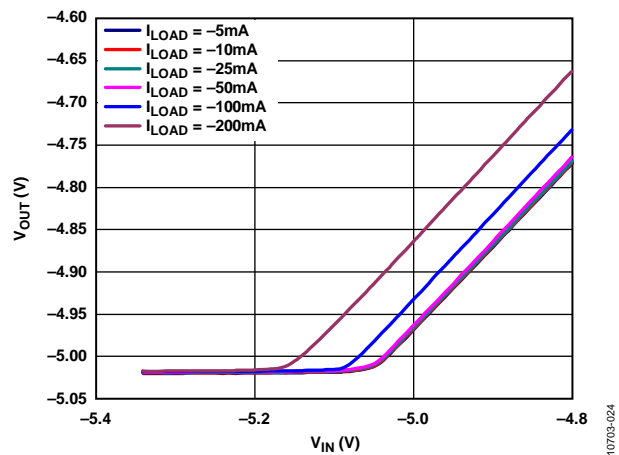

Figure 24. Output Voltage ( $V_{OUT}$ ) vs. Input Voltage ( $V_{IN}$ ) in Dropout,  $V_{OUT} = -5\text{ V}$

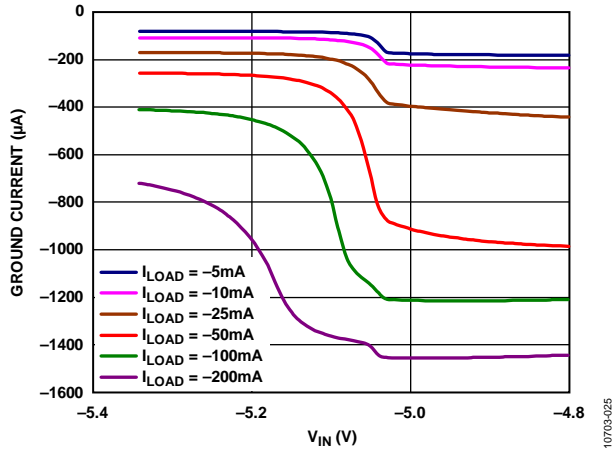

Figure 25. Ground Current vs. Input Voltage ( $V_{IN}$ ) in Dropout,  $V_{OUT} = -5\text{ V}$

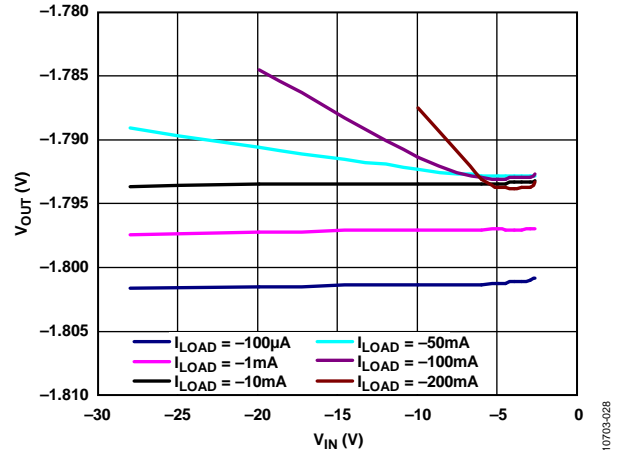

Figure 28. Output Voltage ( $V_{OUT}$ ) vs. Input Voltage ( $V_{IN}$ ),  $V_{OUT} = -1.8\text{ V}$

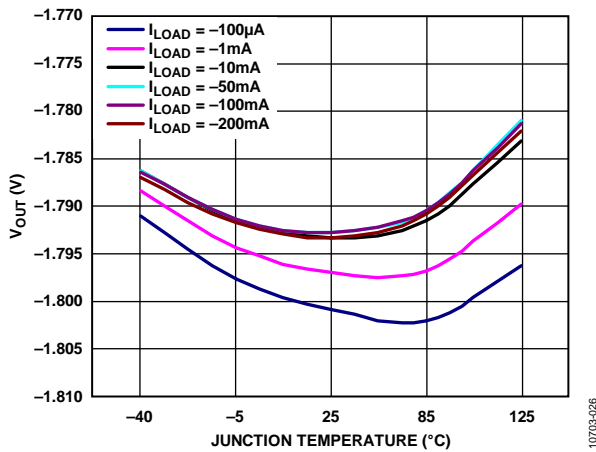

Figure 26. Output Voltage ( $V_{OUT}$ ) vs. Junction Temperature ( $T_j$ ),  $V_{OUT} = -1.8\text{ V}$

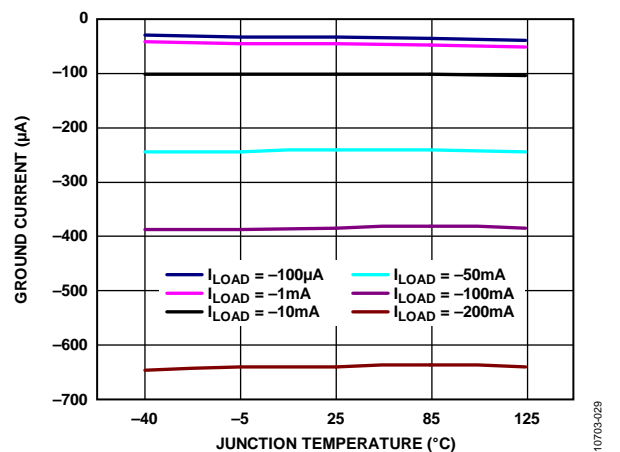

Figure 29. Ground Current vs. Junction Temperature ( $T_j$ ),  $V_{OUT} = -1.8\text{ V}$

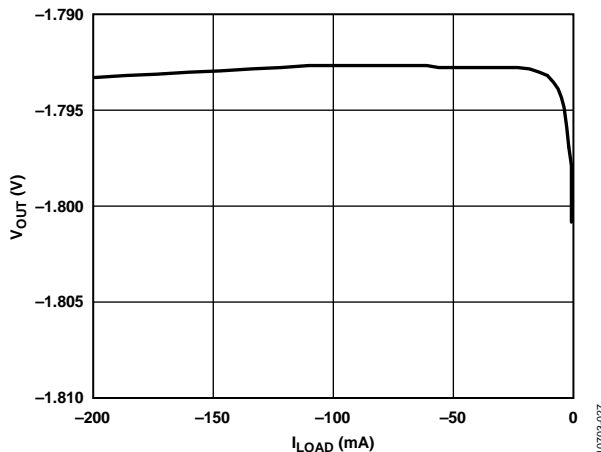

Figure 27. Output Voltage ( $V_{OUT}$ ) vs. Load Current ( $I_{LOAD}$ ),  $V_{OUT} = -1.8\text{ V}$

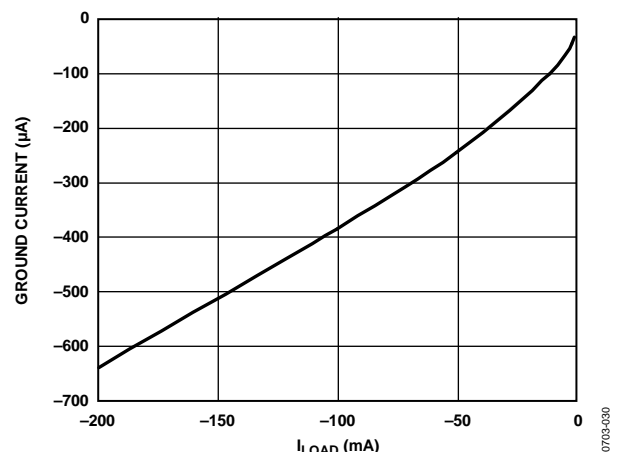

Figure 30. Ground Current vs. Load Current ( $I_{LOAD}$ ),  $V_{OUT} = -1.8\text{ V}$

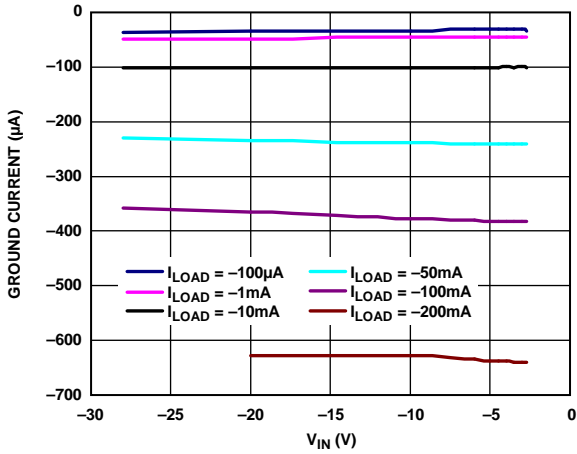

Figure 31. Ground Current vs. Input Voltage ( $V_{IN}$ ),  $V_{OUT} = -1.8 V$

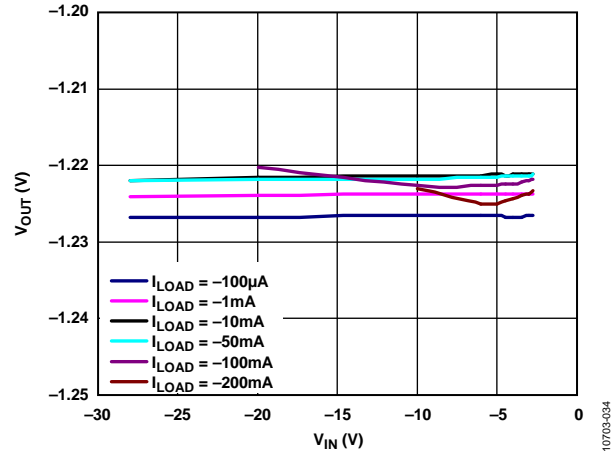

Figure 34. Output Voltage ( $V_{OUT}$ ) vs. Input Voltage ( $V_{IN}$ ),  $V_{OUT} = -1.22 V$

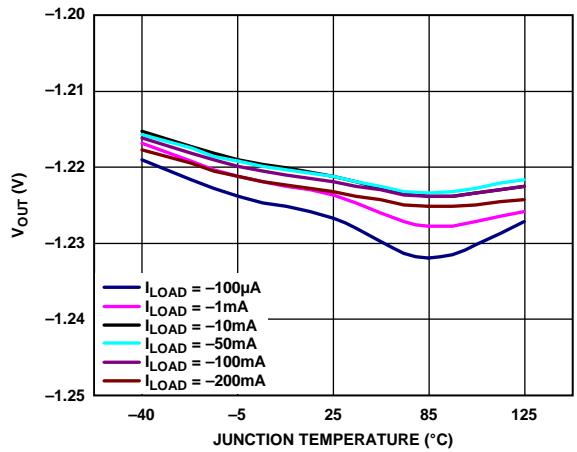

Figure 32. Output Voltage ( $V_{OUT}$ ) vs. Junction Temperature ( $T_J$ ),  $V_{OUT} = -1.22 V$

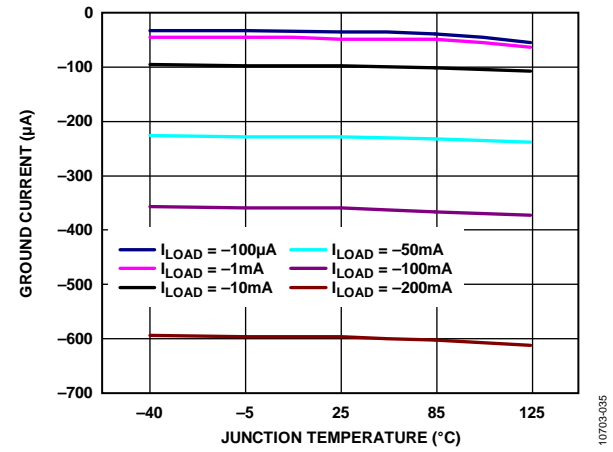

Figure 35. Ground Current vs. Junction Temperature ( $T_J$ ),  $V_{OUT} = -1.22 V$

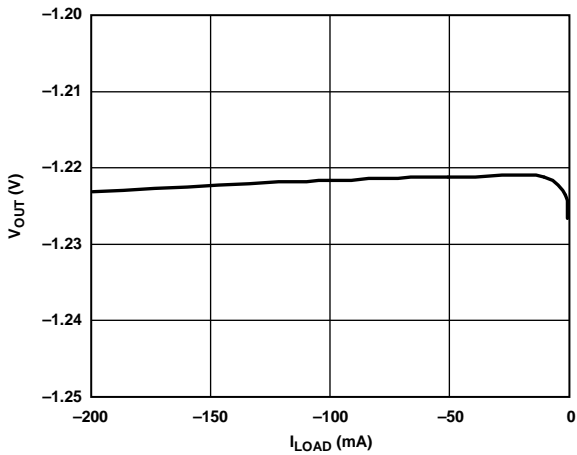

Figure 33. Output Voltage ( $V_{OUT}$ ) vs. Load Current ( $I_{LOAD}$ ),  $V_{OUT} = -1.22 V$

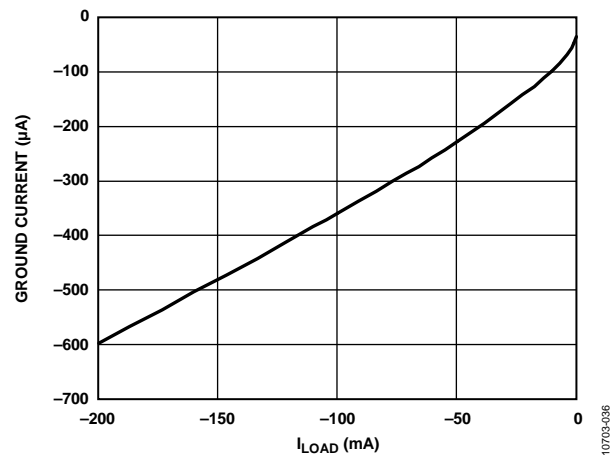

Figure 36. Ground Current vs. Load Current ( $I_{LOAD}$ ),  $V_{OUT} = -1.22 V$

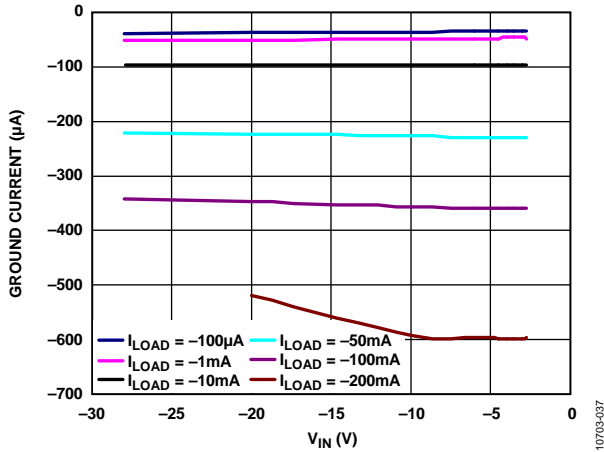

Figure 37. Ground Current vs. Input Voltage ( $V_{IN}$ ),  $V_{OUT} = -1.22 V$

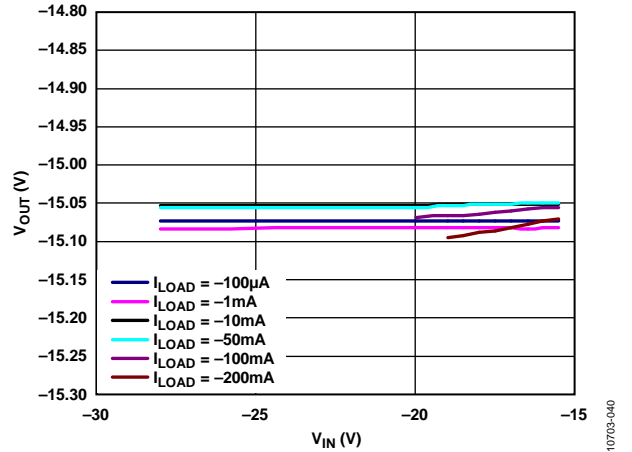

Figure 40. Output Voltage ( $V_{OUT}$ ) vs. Input Voltage ( $V_{IN}$ ), Adjustable Output Voltage,  $V_{OUT} = -15 V$

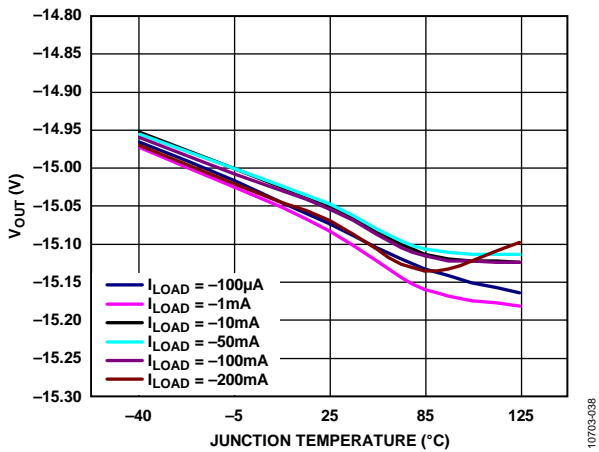

Figure 38. Output Voltage ( $V_{OUT}$ ) vs. Junction Temperature ( $T_J$ ), Adjustable Output Voltage,  $V_{OUT} = -15 V$

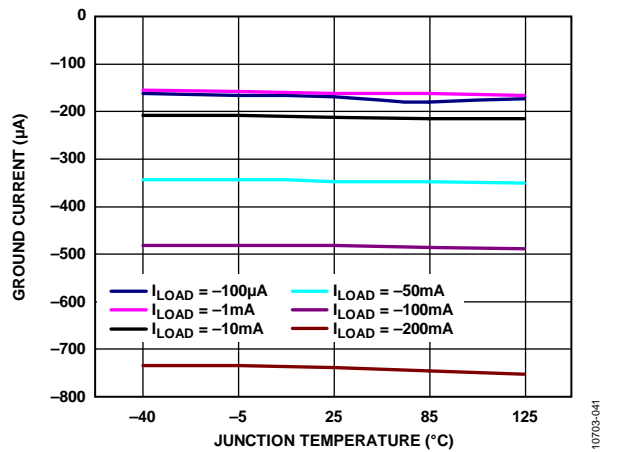

Figure 41. Ground Current vs. Junction Temperature ( $T_J$ ), Adjustable Output Voltage,  $V_{OUT} = -15 V$

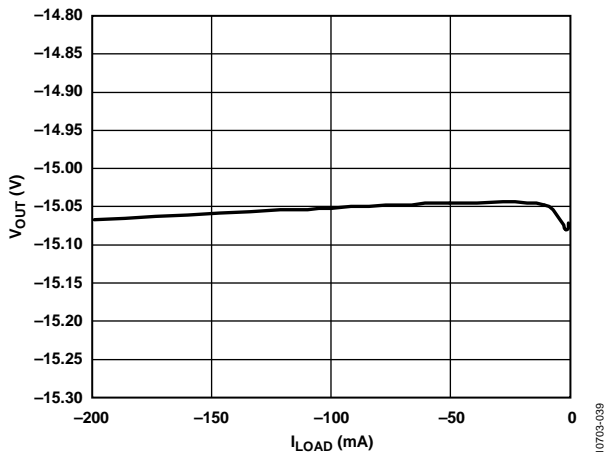

Figure 39. Output Voltage ( $V_{OUT}$ ) vs. Load Current ( $I_{LOAD}$ ), Adjustable Output Voltage,  $V_{OUT} = -15 V$

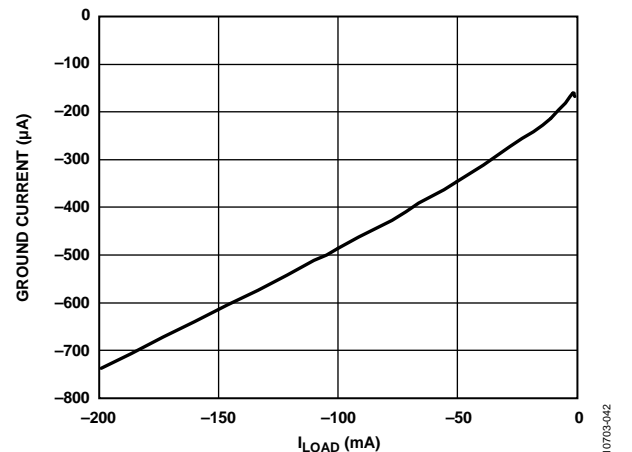

Figure 42. Ground Current vs. Load Current ( $I_{LOAD}$ ), Adjustable Output Voltage,  $V_{OUT} = -15 V$

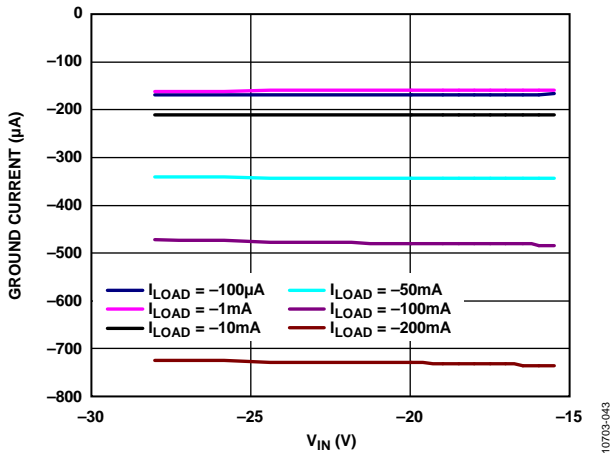

Figure 43. Ground Current vs. Input Voltage ( $V_{IN}$ ), Adjustable Output Voltage,  $V_{OUT} = -15\text{ V}$

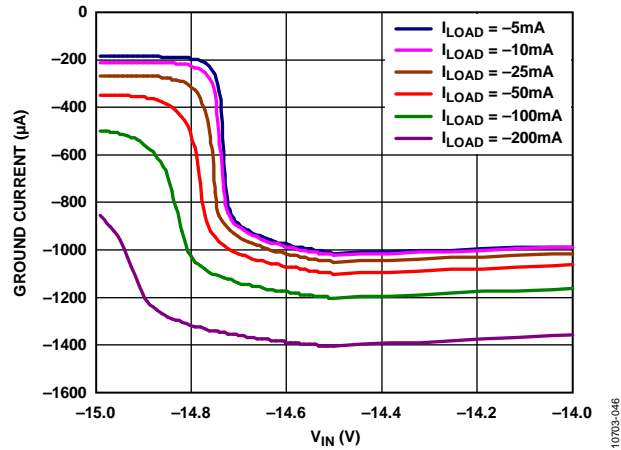

Figure 46. Ground Current vs. Input Voltage ( $V_{IN}$ ) in Dropout,  $V_{OUT} = -15\text{ V}$

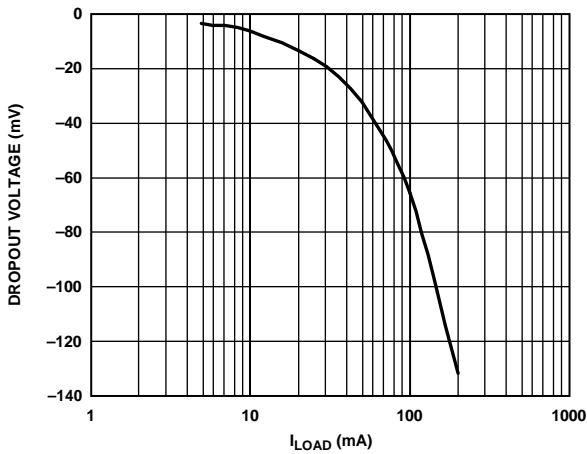

Figure 44. Dropout Voltage vs. Load Current ( $I_{LOAD}$ ), Adjustable Output Voltage,  $V_{OUT} = -15\text{ V}$

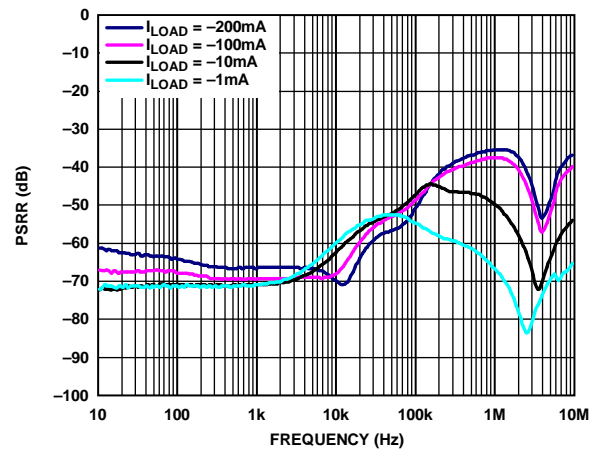

Figure 47. Power Supply Rejection Ratio (PSRR) vs. Frequency,  $V_{OUT} = -1.22\text{ V}$  vs. Different Load Currents ( $I_{LOAD}$ ),  $V_{IN} = -2.7\text{ V}$

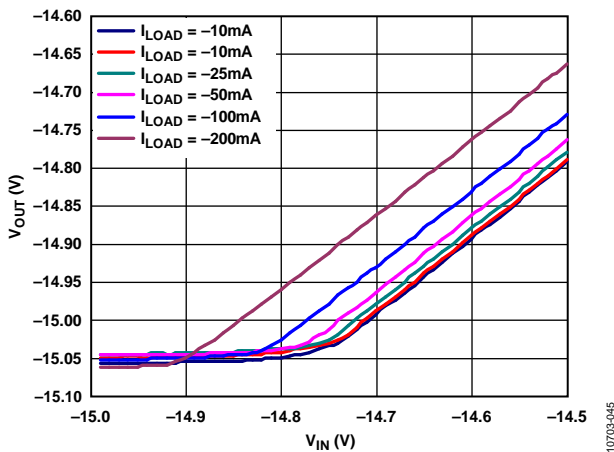

Figure 45. Output Voltage ( $V_{OUT}$ ) vs. Input Voltage ( $V_{IN}$ ) in Dropout, Adjustable Output Voltage,  $V_{OUT} = -15\text{ V}$

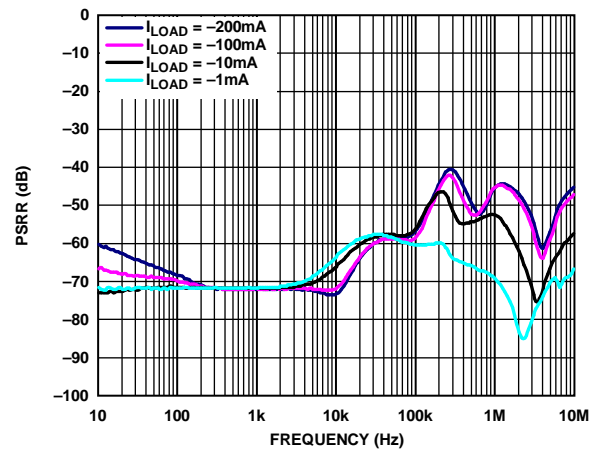

Figure 48. Power Supply Rejection Ratio (PSRR) vs. Frequency,  $V_{OUT} = -1.22\text{ V}$  vs. Different Load Currents ( $I_{LOAD}$ ),  $V_{IN} = -5.7\text{ V}$

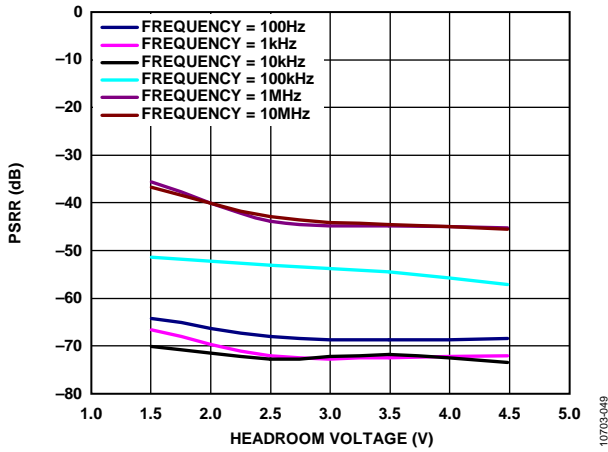

Figure 49. Power Supply Rejection Ratio (PSRR) vs. Headroom Voltage,  $V_{OUT} = -1.22\text{ V}$ , Load Current ( $I_{LOAD}$ ) =  $-200\text{ mA}$

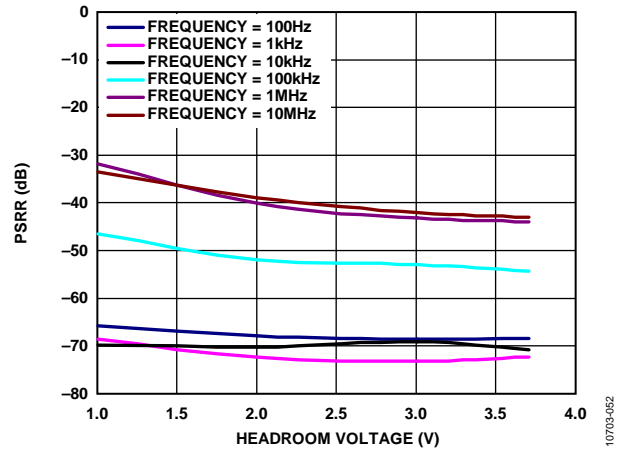

Figure 52. Power Supply Rejection Ratio (PSRR) vs. Headroom Voltage,  $V_{OUT} = -1.8\text{ V}$ , Load Current ( $I_{LOAD}$ ) =  $-200\text{ mA}$

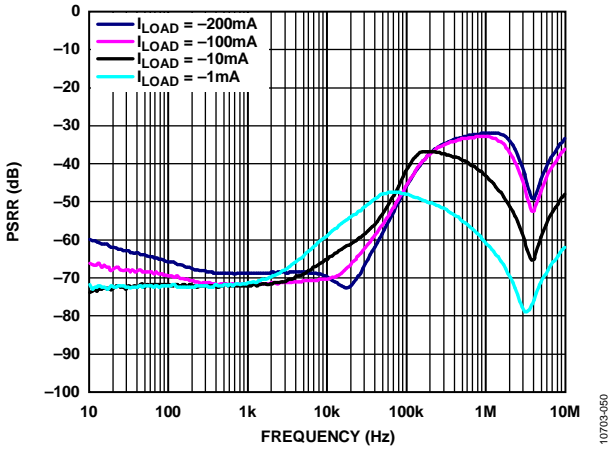

Figure 50. Power Supply Rejection Ratio (PSRR) vs. Frequency,  $V_{OUT} = -1.8\text{ V}$  vs. Different Load Currents ( $I_{LOAD}$ ),  $V_{IN} = -2.8\text{ V}$

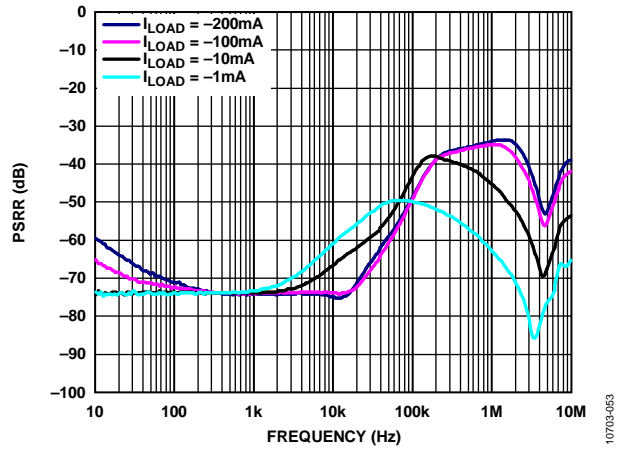

Figure 53. Power Supply Rejection Ratio (PSRR) vs. Frequency,  $V_{OUT} = -3\text{ V}$  vs. Different Load Currents ( $I_{LOAD}$ ),  $V_{IN} = -4.0\text{ V}$

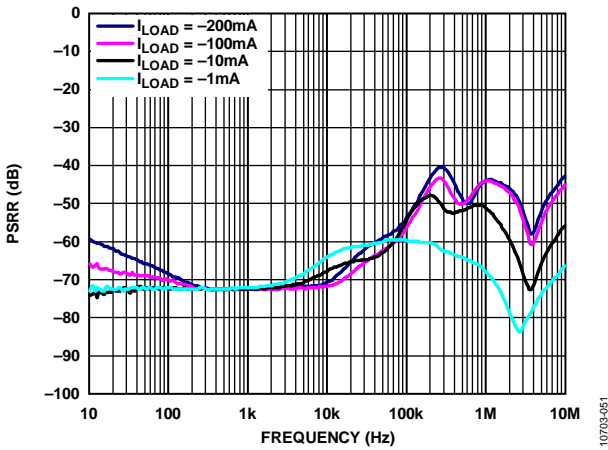

Figure 51. Power Supply Rejection Ratio (PSRR) vs. Frequency,  $V_{OUT} = -1.8\text{ V}$  vs. Different Load Currents ( $I_{LOAD}$ ),  $V_{IN} = -5.5\text{ V}$

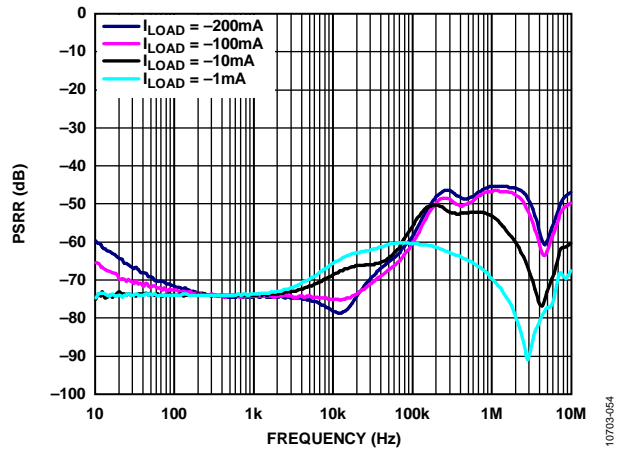

Figure 54. Power Supply Rejection Ratio (PSRR) vs. Frequency,  $V_{OUT} = -3\text{ V}$  vs. Different Load Currents ( $I_{LOAD}$ ),  $V_{IN} = -5.5\text{ V}$

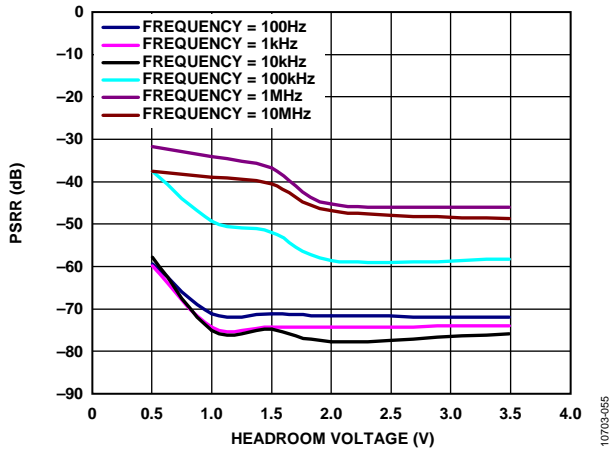

Figure 55. Power Supply Rejection Ratio (PSRR) vs. Headroom Voltage,  $V_{OUT} = -3\text{ V}$ , Load Current ( $I_{LOAD}$ ) =  $-200\text{ mA}$

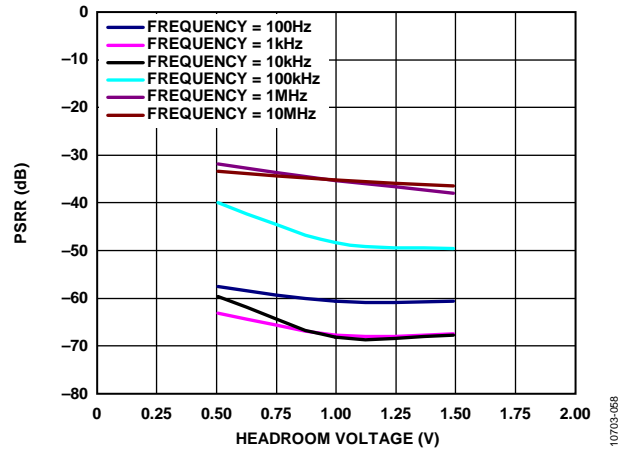

Figure 58. Power Supply Rejection Ratio (PSRR) vs. Headroom Voltage, Adjustable Output Voltage,  $V_{OUT} = -15\text{ V}$  with Noise Reduction Network, Load Current ( $I_{LOAD}$ ) =  $-200\text{ mA}$

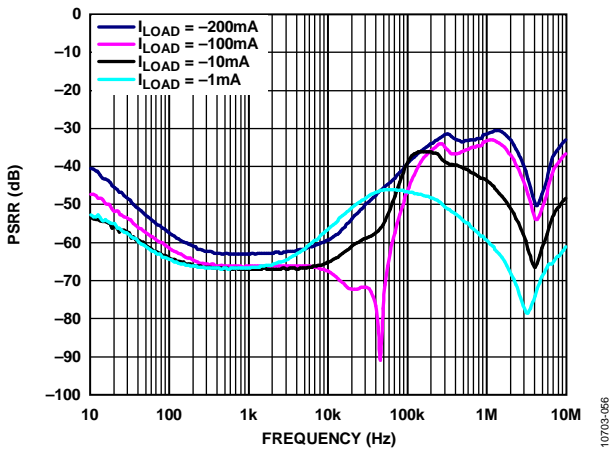

Figure 56. Power Supply Rejection Ratio (PSRR) vs. Frequency, Adjustable Output Voltage,  $V_{OUT} = -15\text{ V}$  vs. Different Load Currents ( $I_{LOAD}$ ),  $V_{IN} = -15.5\text{ V}$  with Noise Reduction Network

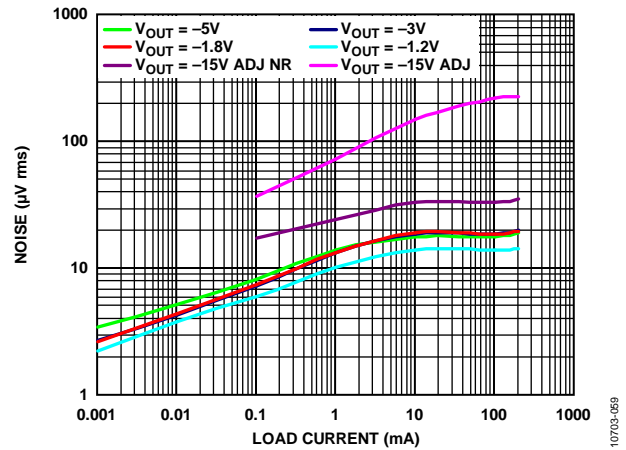

Figure 59. RMS Noise vs. Load Current ( $I_{LOAD}$ ), Various Output Voltages

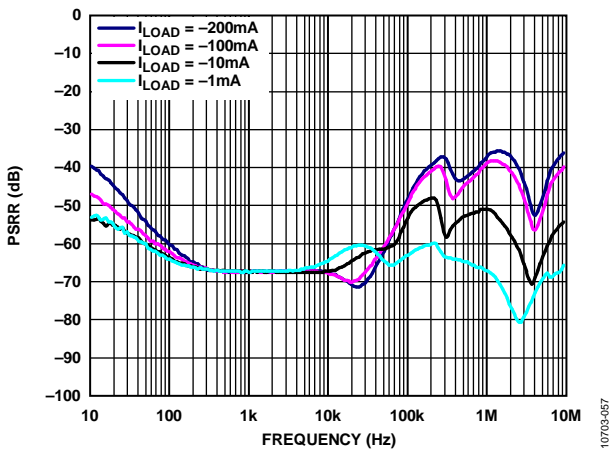

Figure 57. Power Supply Rejection Ratio (PSRR) vs. Frequency, Adjustable Output Voltage,  $V_{OUT} = -15\text{ V}$  vs. Different Load Currents ( $I_{LOAD}$ ),  $V_{IN} = -16.5\text{ V}$  with Noise Reduction Network

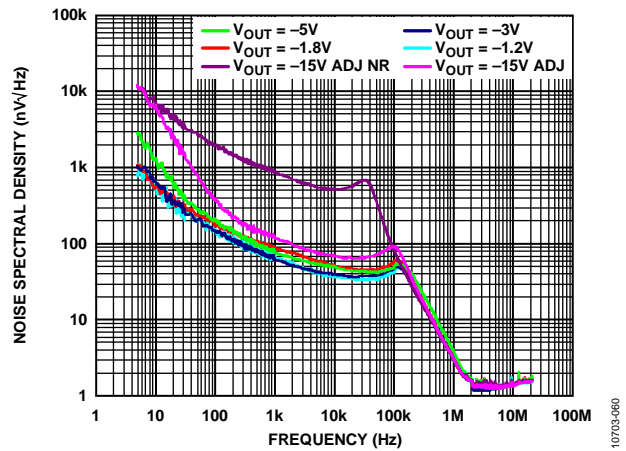

Figure 60. Noise Spectral Density, Various Output Voltages



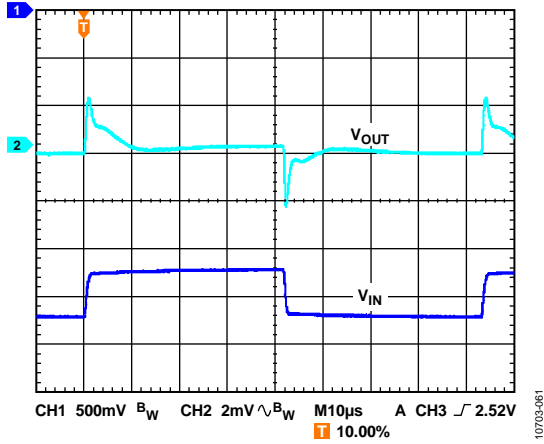

Figure 61. Line Transient Response, 500 mV Step,  $V_{OUT} = -1.22\text{ V}$ ,  $I_{LOAD} = -200\text{ mA}$

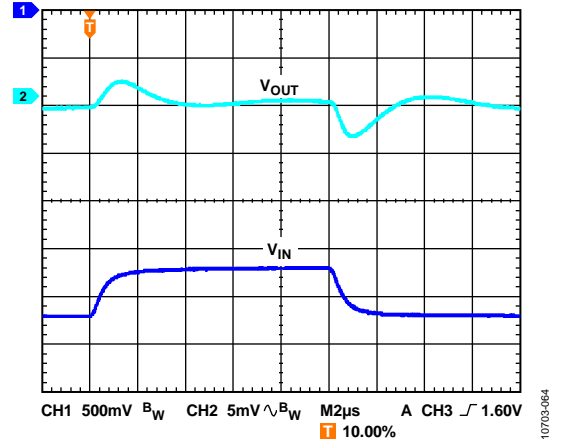

Figure 64. Line Transient Response, 500 mV Step,  $V_{OUT} = -1.8\text{ V}$ ,  $I_{LOAD} = -10\text{ mA}$

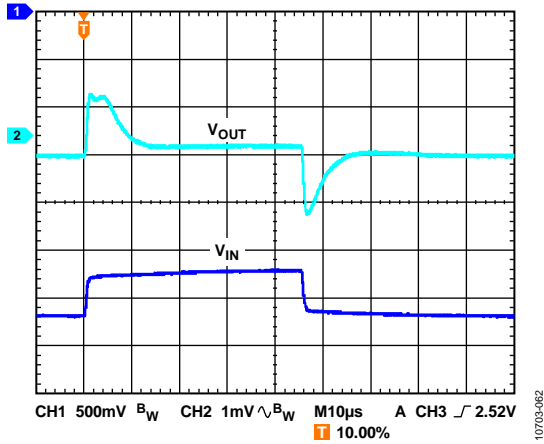

Figure 62. Line Transient Response, 500 mV Step,  $V_{OUT} = -1.22\text{ V}$ ,  $I_{LOAD} = -10\text{ mA}$

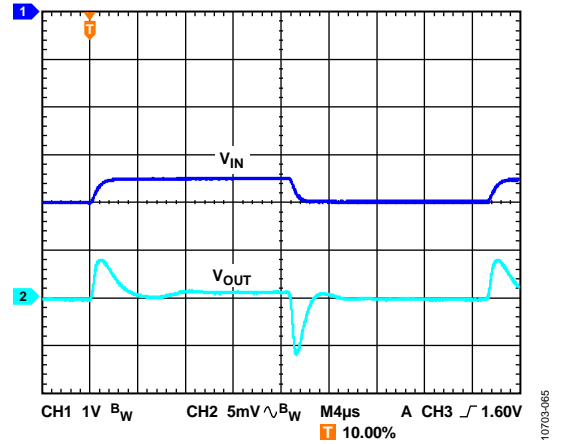

Figure 65. Line Transient Response, 500 mV Step,  $V_{OUT} = -3\text{ V}$ ,  $I_{LOAD} = -200\text{ mA}$

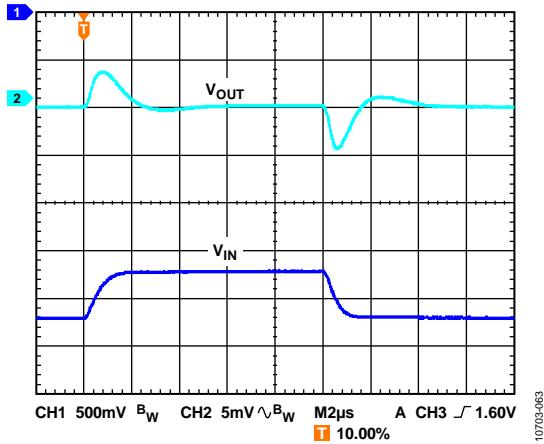

Figure 63. Line Transient Response, 500 mV Step,  $V_{OUT} = -1.8\text{ V}$ ,  $I_{LOAD} = -200\text{ mA}$

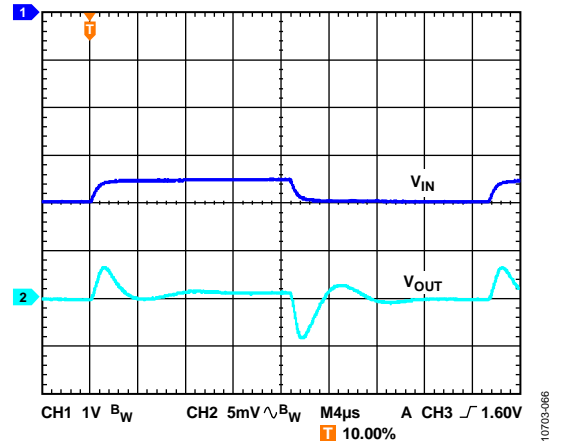

Figure 66. Line Transient Response, 500 mV Step,  $V_{OUT} = -3\text{ V}$ ,  $I_{LOAD} = -10\text{ mA}$

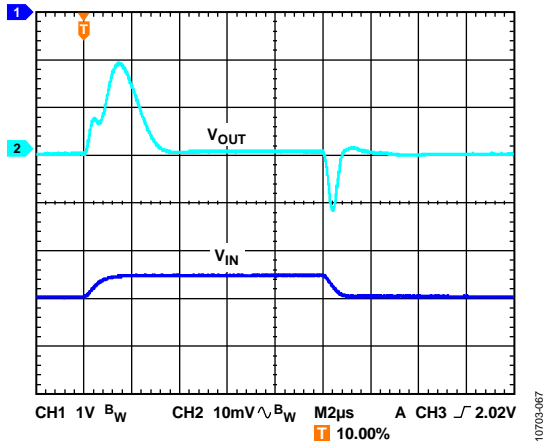

Figure 67. Line Transient Response, 500 mV Step,  $V_{OUT} = -5\text{ V}$ ,  $I_{LOAD} = -200\text{ mA}$

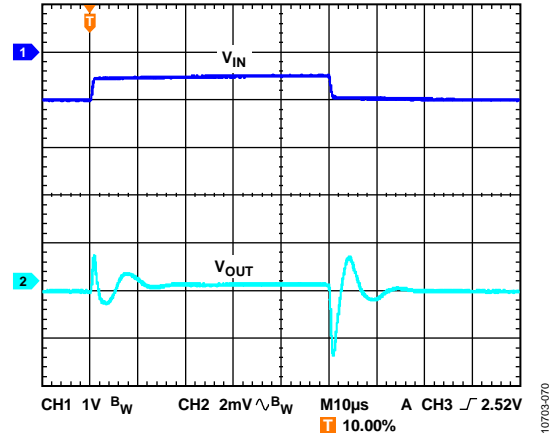

Figure 70. Line Transient Response, 500 mV Step,  $V_{OUT} = -15\text{ V}$ , Noise Reduction Network,  $I_{LOAD} = -10\text{ mA}$

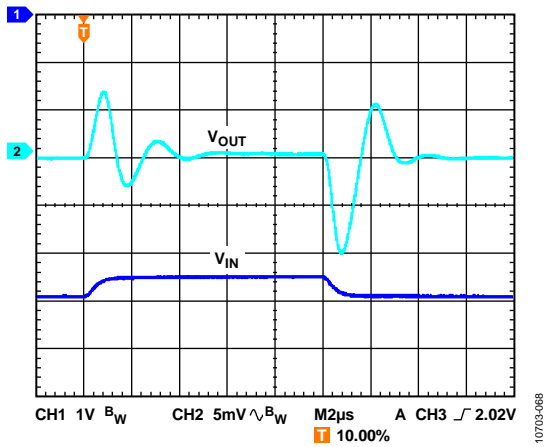

Figure 68. Line Transient Response, 500 mV Step,  $V_{OUT} = -5\text{ V}$ ,  $I_{LOAD} = -10\text{ mA}$

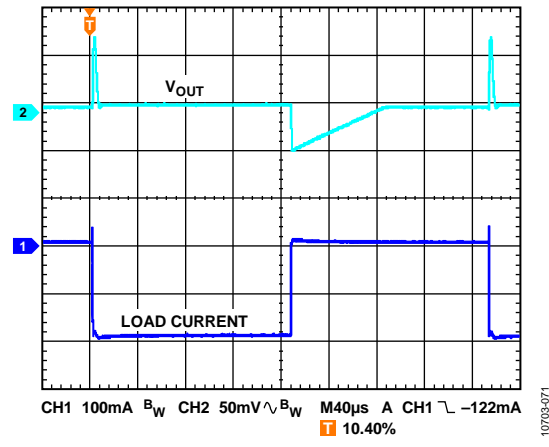

Figure 71. Load Transient Response,  $V_{OUT} = -1.22\text{ V}$ ,  $I_{LOAD} = -1\text{ mA to } -200\text{ mA}$ , Load Step =  $1\text{ A}/\mu\text{s}$

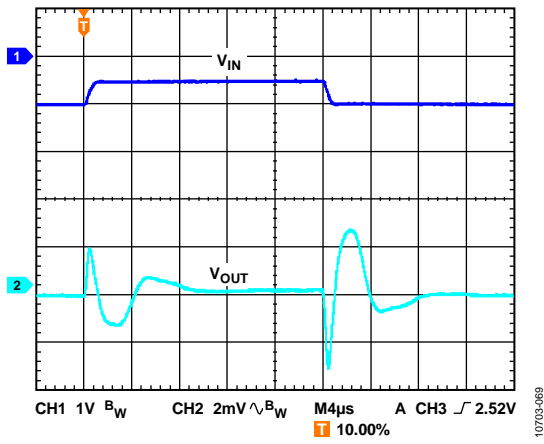

Figure 69. Line Transient Response, 500 mV Step,  $V_{OUT} = -15\text{ V}$ , Noise Reduction Network,  $I_{LOAD} = -200\text{ mA}$

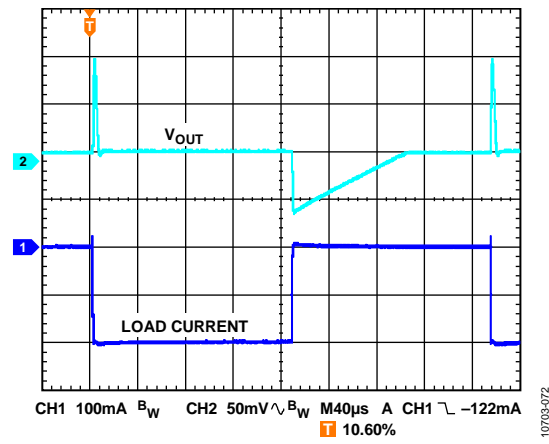

Figure 72. Load Transient Response,  $V_{OUT} = -3\text{ V}$ ,  $I_{LOAD} = -1\text{ mA to } -200\text{ mA}$ , Load Step =  $1\text{ A}/\mu\text{s}$

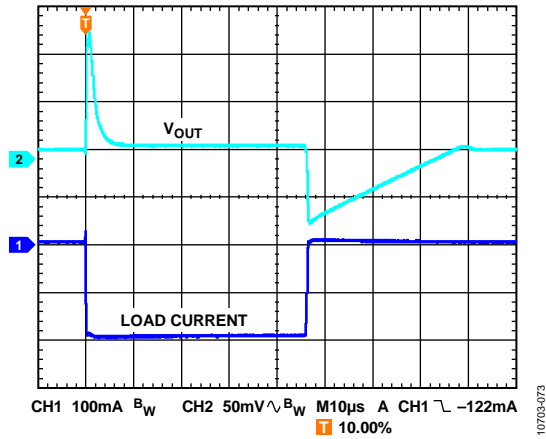

Figure 73. Load Transient Response,  $V_{OUT} = -5\text{ V}$ ,  $I_{LOAD} = -1\text{ mA to } -200\text{ mA}$ ,  
 Load Step =  $1\text{ A}/\mu\text{s}$

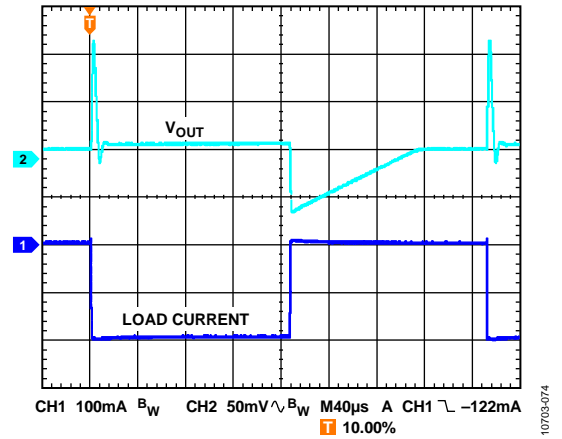

Figure 74. Load Transient Response,  $V_{OUT} = -15\text{ V}$ ,  $I_{LOAD} = -1\text{ mA to } -200\text{ mA}$ ,  
 Load Step =  $1\text{ A}/\mu\text{s}$ , Noise Reduction Network

## THEORY OF OPERATION

The ADP7182 is a low quiescent current, LDO linear regulator that operates from  $-2.7\text{ V}$  to  $-28\text{ V}$  and can provide up to  $-200\text{ mA}$  of output current. Drawing a low  $-650\text{ }\mu\text{A}$  of quiescent current (typical) at full load makes the ADP7182 ideal for battery-powered portable equipment. Maximum shutdown current consumption is  $-8\text{ }\mu\text{A}$  at room temperature.

Optimized for use with small  $2.2\text{ }\mu\text{F}$  ceramic capacitors, the ADP7182 provides excellent transient performance.

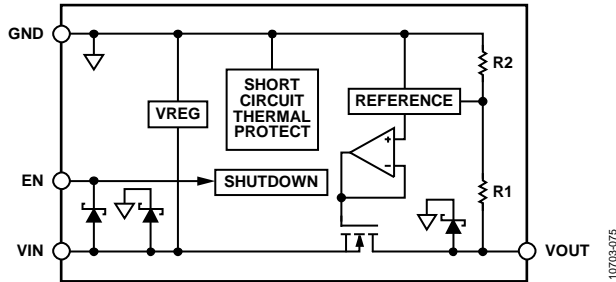

Figure 75. Fixed Output Voltage Internal Block Diagram

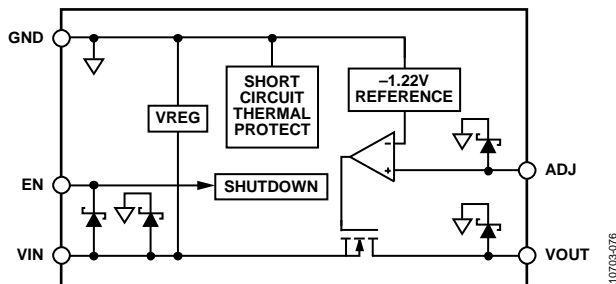

Figure 76. Adjustable Output Voltage Internal Block Diagram

Internally, the ADP7182 consists of a reference, an error amplifier, a feedback voltage divider, and an NMOS pass transistor. Output current is delivered via the NMOS pass transistor, which is controlled by the error amplifier. The error amplifier compares the reference voltage with the feedback voltage from the output and amplifies the difference. If the feedback voltage is more positive than the reference voltage, the gate of the NMOS transistor is pulled toward GND, allowing more current to pass and increasing the output voltage. If the feedback voltage is more negative than the reference voltage, the gate of the NMOS transistor is pulled toward  $-V_{IN}$ , allowing less current to pass and decreasing the output voltage.

The ESD protection devices are shown in the block diagram as Zener diodes (see Figure 75 and Figure 76).

## ENABLE PIN OPERATION

The ADP7182 uses the EN pin to enable and disable the VOUT pin under normal operating conditions. When EN is at  $\pm 2\text{ V}$  with respect to GND, VOUT turns on, and when EN is at  $0\text{ V}$ , VOUT turns off. For automatic startup, EN can be connected to VIN.

## ADJUSTABLE MODE OPERATION

The ADP7182 is available in a fixed output voltage and an adjustable mode version with an output voltage that can be set to between  $-1.22\text{ V}$  and  $-27\text{ V}$  by an external voltage divider. The output voltage can be set according to

$$-V_{OUT} = -1.22\text{ V} (1 + R_{FB1}/R_{FB2})$$

$R_{FB2}$  must be less than  $120\text{ k}\Omega$  to minimize the output voltage errors due to the leakage current of the ADJ pin. The error voltage caused by the ADJ pin leakage current is the parallel combination of  $R_{FB1}$  and  $R_{FB2}$  times the ADJ pin leakage current.

For example, when  $R_{FB1} = R_{FB2} = 120\text{ k}\Omega$ , the output voltage is  $-2.44\text{ V}$  and the error due to the typical ADJ pin leakage current ( $10\text{ nA}$ ) is  $60\text{ k}\Omega$  times  $10\text{ nA}$ , or  $6\text{ mV}$ . This example results in an output voltage error of  $0.245\%$ .

The addition of a small capacitor ( $\sim 100\text{ pF}$ ) in parallel with  $R_{FB1}$  can improve the stability of the ADP7182. Larger values of capacitance also reduce the noise and improve PSRR (see the Noise Reduction of the Adjustable ADP7182 section).

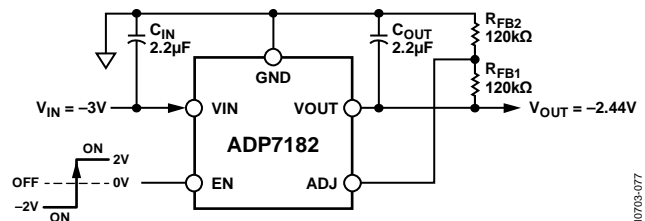

Figure 77. Setting Adjustable Output Voltage

## APPLICATIONS INFORMATION

### ADIsimPower DESIGN TOOL

The ADP7182 is supported by the ADIsimPower™ design tool set. ADIsimPower is a collection of tools that produce complete power designs optimized for a specific design goal. The tools enable the user to generate a full schematic, bill of materials, and calculate performance in minutes. ADIsimPower can optimize designs for cost, area, efficiency, and parts count taking into consideration the operating conditions and limitations of the IC and all real external components. For more information about, and to obtain ADIsimPower design tools, visit [www.analog.com/ADIsimPower](http://www.analog.com/ADIsimPower).

### CAPACITOR SELECTION

#### Output Capacitor

The ADP7182 is designed for operation with small space-saving ceramic capacitors; however, it functions with most commonly used capacitors as long as care is taken with regard to the ESR value. The ESR of the output capacitor affects the stability of the LDO control loop. A minimum of 2.2  $\mu\text{F}$  capacitance with an ESR of 0.2  $\Omega$  or less is recommended to ensure the stability of the ADP7182. Transient response to changes in load current is also affected by output capacitance. Using a larger value of output capacitance improves the transient response of the ADP7182 to large changes in load current. Figure 78 shows the transient responses for an output capacitance value of 2.2  $\mu\text{F}$ .

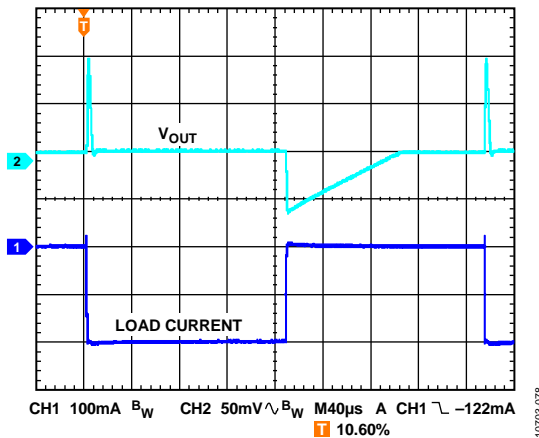

Figure 78. Output Transient Response,  $C_{out} = 2.2 \mu\text{F}$

#### Input Bypass Capacitor

Connecting a 2.2  $\mu\text{F}$  capacitor from VIN to GND reduces the circuit sensitivity to PCB layout, especially when long input traces or high source impedance are encountered. When more than 2.2  $\mu\text{F}$  of output capacitance is required, increase the input capacitance to match it.

#### Input and Output Capacitor Properties

As long as they meet the minimum capacitance and maximum ESR requirements, any good quality ceramic capacitors can be used with the ADP7182. Ceramic capacitors are manufactured with a variety of dielectrics, each with different behavior over

temperature and applied voltage. Capacitors must have a dielectric adequate to ensure the minimum capacitance over the necessary temperature range and dc bias conditions. X5R or X7R dielectrics with a voltage rating of 25 V or 50 V are recommended. Due to their poor temperature and dc bias characteristics, Y5V and Z5U dielectrics are not recommended.

Figure 79 depicts the capacitance vs. voltage bias characteristics of an 0805, 2.2  $\mu\text{F}$ , 25 V, X5R capacitor. The voltage stability of a capacitor is strongly influenced by the capacitor size and voltage rating. In general, a capacitor in a larger package or higher voltage rating exhibits better stability. The temperature variation of the X5R dielectric is  $\sim \pm 15\%$  over the  $-40^\circ\text{C}$  to  $+85^\circ\text{C}$  temperature range and is not a function of package or voltage rating.

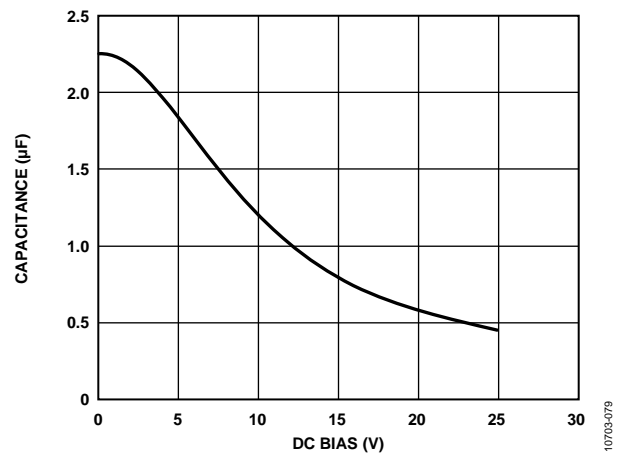

Figure 79. Capacitance vs. DC Bias Characteristics

Use Equation 1 to determine the worst-case capacitance accounting for capacitor variation over temperature, component tolerance, and voltage.

$$C_{EFF} = C_{BIAS} \times (1 - TEMPCO) \times (1 - TOL) \quad (1)$$

where:

$C_{BIAS}$  is the effective capacitance at the operating voltage, which is  $-3 \text{ V}$  for this example.

$TEMPCO$  is the worst-case capacitor temperature coefficient.

$TOL$  is the worst-case component tolerance.

In this example, the worst-case temperature coefficient ( $TEMPCO$ ) over  $-40^\circ\text{C}$  to  $+85^\circ\text{C}$  is 15% for an X5R dielectric. The tolerance of the capacitor ( $TOL$ ) is 10%, and the  $C_{BIAS}$  is 2.08  $\mu\text{F}$  at a 3 V bias, as shown in Figure 79.

Substituting these values in Equation 1 yields

$$C_{EFF} = 2.08 \mu\text{F} \times (1 - 0.15) \times (1 - 0.1) = 1.59 \mu\text{F}$$

Therefore, the capacitor chosen in this example meets the minimum capacitance requirement of the LDO over temperature and tolerance at the chosen output voltage of  $-3 \text{ V}$ .

To guarantee the performance of the ADP7182, it is imperative that the effects of dc bias, temperature, and tolerances on the behavior of the capacitors be evaluated for each application.

**ENABLE PIN OPERATION**

The ADP7182 provides a dual polarity enable pin (EN) that turns on the LDO when  $|V_{EN}| \geq 2\text{ V}$ . The enable voltage can be positive or negative with respect to ground.

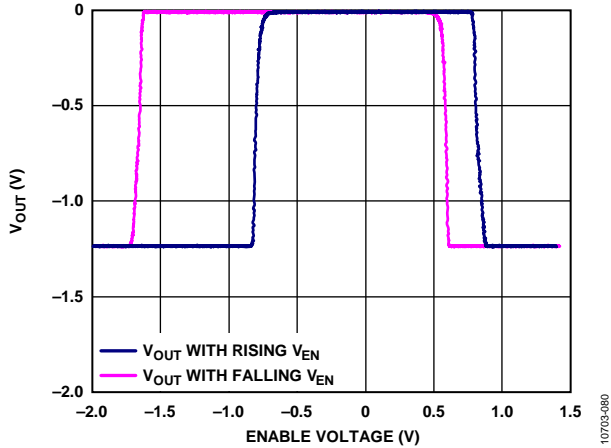

Figure 80. Typical EN Pin Operation

Figure 80 shows the typical hysteresis of the EN pin. This prevents on/off oscillations that can occur due to noise on the EN pin as it passes through the threshold points.

Figure 81 shows typical EN thresholds when the input voltage varies from  $-2.7\text{ V}$  to  $-28\text{ V}$ .

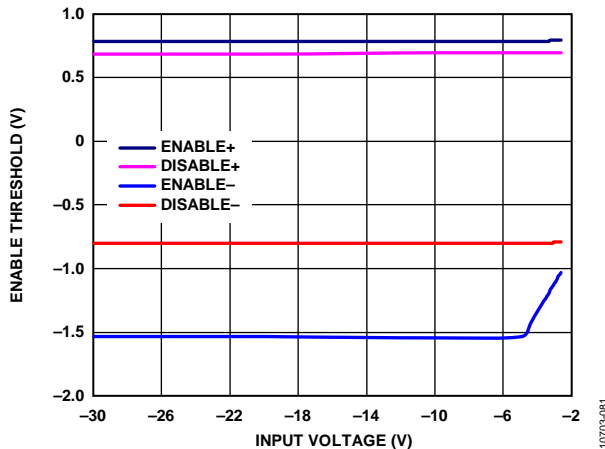

Figure 81. Typical EN Pin Thresholds vs. Input Voltage

Figure 82 and Figure 83 show the start-up behavior for a  $-5\text{ V}$  output with positive and negative going enable signals.

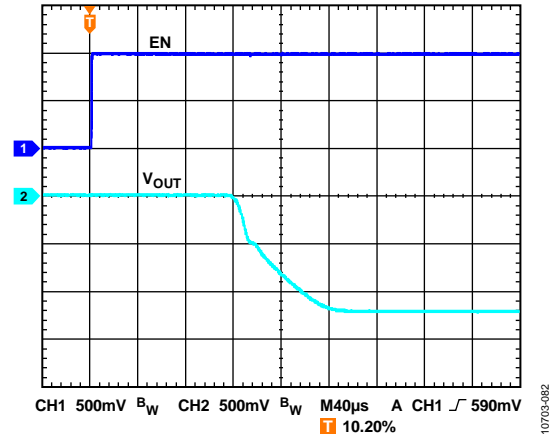

Figure 82. Typical Start-Up Behavior, Positive Going Enable

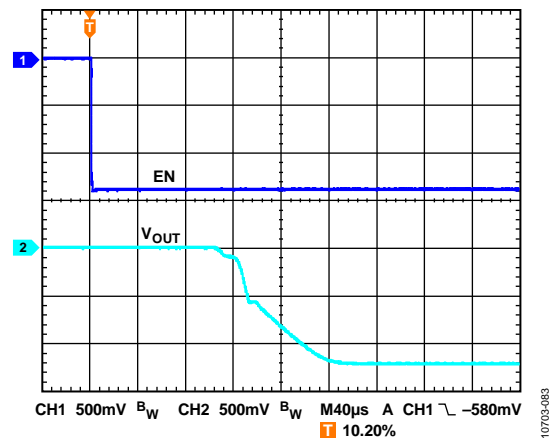

Figure 83. Typical Start-Up Behavior, Negative Going Enable

**SOFT START**

The ADP7182 uses an internal soft start to limit the inrush current when the output is enabled. The start-up time for the  $-5\text{ V}$  option is approximately  $450\text{ }\mu\text{s}$  from the time the EN active threshold is crossed to when the output reaches 90% of its final value. As shown in Figure 84, the start-up time is dependent on the output voltage setting.

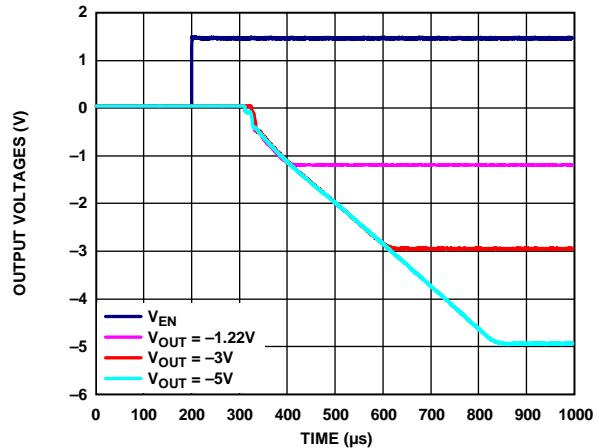

Figure 84. Typical Start-Up Behavior, Different Output Voltages

## NOISE REDUCTION OF THE ADJUSTABLE ADP7182

The ultralow output noise of the fixed output ADP7182 is achieved by keeping the LDO error amplifier in unity gain and setting the reference voltage equal to the output voltage. This architecture does not work for an adjustable output voltage LDO. The adjustable output ADP7182 uses the more conventional architecture where the reference voltage is fixed and the error amplifier gain is a function of the output voltage. The disadvantage of the conventional LDO architecture is that the output voltage noise is proportional to the output voltage.

The adjustable LDO circuit can be modified slightly to reduce the output voltage noise to levels close to that of the fixed output of the ADP7182. The circuit shown in Figure 85 adds two additional components to the output voltage setting resistor divider.  $C_{NR}$  and  $R_{NR}$  are added in parallel with  $R_{FB1}$  to reduce the ac gain of the error amplifier.  $R_{NR}$  is chosen to be nearly equal to  $R_{FB2}$ ; this limits the ac gain of the error amplifier to approximately 6 dB. The actual gain is the parallel combination of  $R_{NR}$  and  $R_{FB1}$  divided by  $R_{FB2}$ . This resistance ensures that the error amplifier always operates at greater than unity gain.

$C_{NR}$  is chosen by setting the reactance of  $C_{NR}$  equal to  $R_{FB1} - R_{NR}$  at a frequency between 10 Hz and 100 Hz. This capacitance sets the frequency where the ac gain of the error amplifier is 3 dB down from its dc gain.

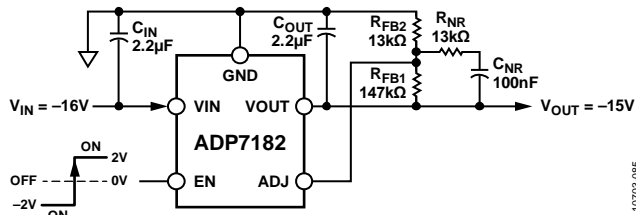

Figure 85. Noise Reduction Modification to Adjustable LDO

The noise of the LDO is approximately the noise of the fixed output LDO (typically 18  $\mu\text{V}$  rms) times  $R_{FB2}$ , divided by the parallel combination of  $R_{NR}$  and  $R_{FB1}$ . Based on the component values shown in Figure 85, the ADP7182 has the following characteristics:

- DC gain of 12.3 (21.8 dB)
- 3 dB roll-off frequency of 10.8 Hz
- High frequency ac gain of 1.92 (5.67 dB)
- Noise reduction factor of 6.41 (16.13 dB)
- Measured rms noise of the adjustable LDO at  $-200$  mA without noise reduction of 220  $\mu\text{V}$  rms
- Measured rms noise of the adjustable LDO at  $-200$  mA with noise reduction circuit of 35  $\mu\text{V}$  rms
- Calculated rms noise of the adjustable LDO with noise reduction (assuming 18  $\mu\text{V}$  rms for fixed voltage option) of 34.5  $\mu\text{V}$  rms

The noise of the LDO is approximately the noise of the fixed output LDO (typically 18  $\mu\text{V}$  rms) times the high frequency ac gain. The following equation shows the calculation with the values shown in Figure 85.

$$18 \mu\text{V} \times \left( 1 + \left( \frac{1}{1/13 \text{ k}\Omega + 1/147 \text{ k}\Omega} \right) / 13 \text{ k}\Omega \right) \quad (2)$$

Figure 86 shows the difference in noise spectral density for the adjustable ADP7182 set to  $-15$  V with and without the noise reduction network. In the 100 Hz to 30 kHz frequency range, the reduction in noise is significant.

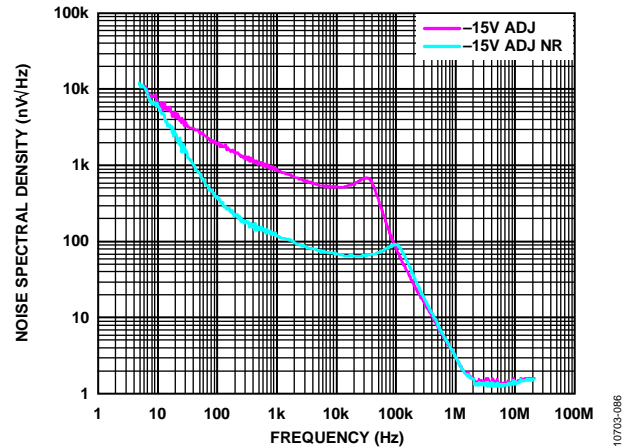

Figure 86.  $-15$  V Adjustable ADP7182 with and without the Noise Reduction Network ( $C_{NR}$  and  $R_{NR}$ )

## CURRENT-LIMIT AND THERMAL OVERLOAD PROTECTION

The ADP7182 is protected against damage due to excessive power dissipation by current-limit and thermal overload protection circuits. The ADP7182 is designed to limit current when the output load reaches  $-350$  mA (typical). When the output load exceeds  $-350$  mA, the output voltage is reduced to maintain a constant current limit.

Thermal overload protection is included, which limits the junction temperature to a maximum of  $150^\circ\text{C}$  (typical). Under extreme conditions (that is, high ambient temperature and power dissipation) when the junction temperature starts to rise above  $150^\circ\text{C}$ , the output is turned off, reducing the output current to 0 mA. When the junction temperature falls below  $135^\circ\text{C}$ , the output is turned on again, and the output current is restored to its nominal value.

Consider the case where a hard short from VOUT to ground occurs. At first, the ADP7182 limits current so that only  $-350$  mA is conducted into the short. If self-heating of the junction is great enough to cause its temperature to rise above  $150^\circ\text{C}$ , thermal shutdown is activated, turning off the output and reducing the output current to 0 mA. As the junction temperature cools and falls below  $135^\circ\text{C}$ , the output turns on and conducts  $-350$  mA into the short, again causing the junction temperature to rise above  $150^\circ\text{C}$ . This thermal oscillation between  $135^\circ\text{C}$  and  $150^\circ\text{C}$  causes a current oscillation between  $-350$  mA and 0 mA that continues as long as the short remains at the output.

Current-limit and thermal overload protections are intended to protect the device against accidental overload conditions. For

reliable operation, device power dissipation must be externally limited so that the junction temperatures do not exceed 125°C.

**THERMAL CONSIDERATIONS**

In most applications, the ADP7182 does not dissipate much heat due to its high efficiency. However, in applications with high ambient temperature, and high supply voltage to output voltage differential, the heat dissipated in the package is large enough that it can cause the junction temperature of the die to exceed the maximum junction temperature of 125°C.

When the junction temperature exceeds 150°C, the converter enters thermal shutdown. It recovers only after the junction temperature has decreased below 135°C to prevent any permanent damage. Therefore, thermal analysis for the chosen application is important to guarantee reliable performance over all conditions. The junction temperature of the die is the sum of the ambient temperature of the environment and the temperature rise of the package due to the power dissipation, as shown in Equation 3.

To guarantee reliable operation, the junction temperature of the ADP7182 must not exceed 125°C. To ensure that the junction temperature stays below this maximum value, the user must be aware of the parameters that contribute to junction temperature changes. These parameters include ambient temperature, power dissipation in the power device, and thermal resistances between the junction and ambient air ( $\theta_{JA}$ ). The  $\theta_{JA}$  number is dependent on the package assembly compounds that are used, and the amount of copper used to solder the package GND pins to the PCB.

Table 7 and Table 8 show typical  $\theta_{JA}$  values of the 8-lead LFCSP and 5-lead TSOT packages for various PCB copper sizes. Table 9 shows the typical  $\Psi_{JB}$  values of the 8-lead LFCSP and 5-lead TSOT.

**Table 7. Typical  $\theta_{JA}$  Values of the 8-Lead LFCSP**

Copper Size (mm <sup>2</sup> )	$\theta_{JA}$ (°C/W)
25 <sup>1</sup>	175
100	135.6
500	77.3
1000	65.2
6400	51

<sup>1</sup> Device soldered to minimum size pin traces.

**Table 8. Typical  $\theta_{JA}$  Values of the 5-Lead TSOT**

Copper Size (mm <sup>2</sup> )	$\theta_{JA}$ (°C/W)
0 <sup>1</sup>	170
50	152
100	146
300	134
500	131

<sup>1</sup> Device soldered to minimum size pin traces.

**Table 9. Typical  $\Psi_{JB}$  Values**

Model	$\Psi_{JB}$ (°C/W)
8-lead LFCSP	18.2
5-lead TSOT	43

The junction temperature of the ADP7182 can be calculated by

$$T_J = T_A + (P_D \times \theta_{JA}) \tag{3}$$

where:

$T_A$  is the ambient temperature.

$P_D$  is the power dissipation in the die, given by

$$P_D = [(V_{IN} - V_{OUT}) \times I_{LOAD}] + (V_{IN} \times I_{GND}) \tag{4}$$

where:

$V_{IN}$  and  $V_{OUT}$  are the input and output voltages, respectively.

$I_{LOAD}$  is the load current.

$I_{GND}$  is the ground current.

Power dissipation due to ground current is quite small and can be ignored. Therefore, the junction temperature equation simplifies to

$$T_J = T_A + \{[(V_{IN} - V_{OUT}) \times I_{LOAD}] \times \theta_{JA}\} \tag{5}$$

As shown in Equation 5, for a given ambient temperature, input-to-output voltage differential, and continuous load current, there exists a minimum copper size requirement for the PCB to ensure that the junction temperature does not rise above 125°C. Figure 87 to Figure 92 show junction temperature calculations for different ambient temperatures, power dissipation, and areas of PCB copper.

Heat dissipation from the package can be improved by increasing the amount of copper attached to the pins of the ADP7182.

Adding thermal planes under the package also improves thermal performance. However, as listed in Table 7 and Table 8, a point of diminishing returns is reached eventually, beyond which an increase in the copper area does not yield significant reduction in the junction-to-ambient thermal resistance.

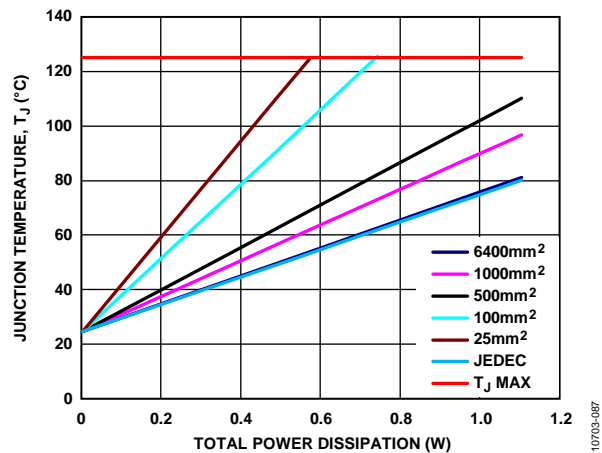

Figure 87. Junction Temperature vs. Total Power Dissipation for the 8-Lead LFCSP,  $T_A = 25^\circ\text{C}$



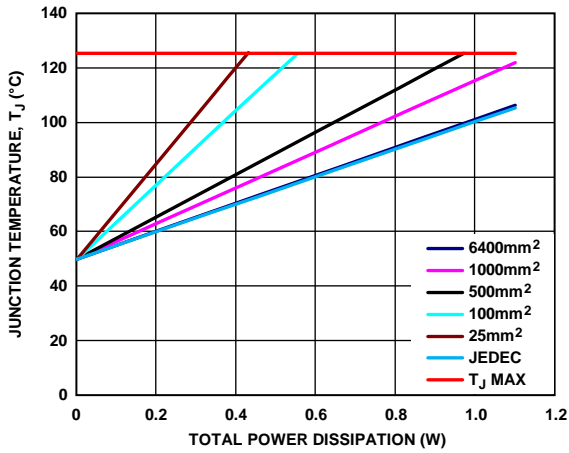

Figure 88. Junction Temperature vs. Total Power Dissipation for the 8-Lead LFCSP,  $T_A = 50^\circ\text{C}$

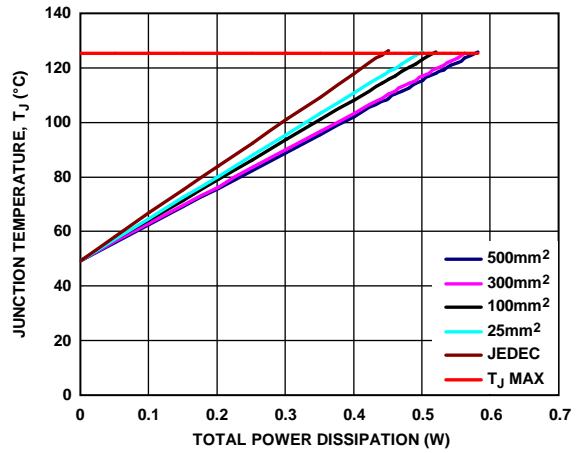

Figure 91. Junction Temperature vs. Total Power Dissipation for the 5-Lead TSOT,  $T_A = 50^\circ\text{C}$

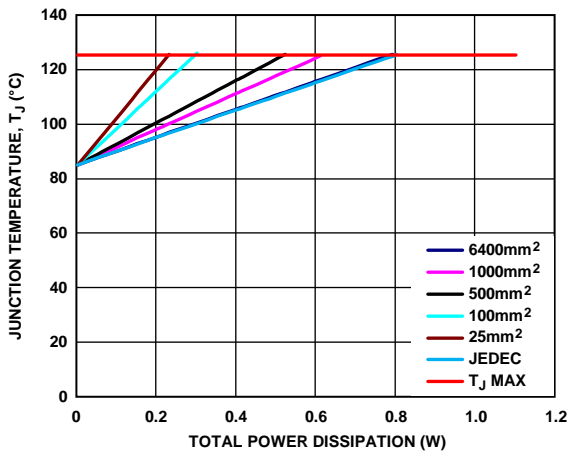

Figure 89. Junction Temperature vs. Total Power Dissipation for the 8-Lead LFCSP,  $T_A = 85^\circ\text{C}$

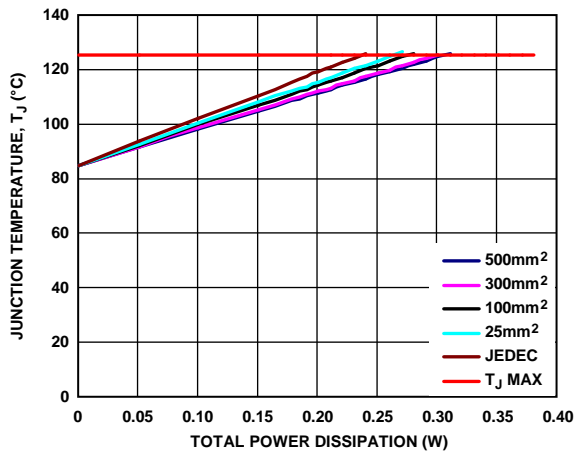

Figure 92. Junction Temperature vs. Total Power Dissipation for the 5-Lead TSOT,  $T_A = 85^\circ\text{C}$

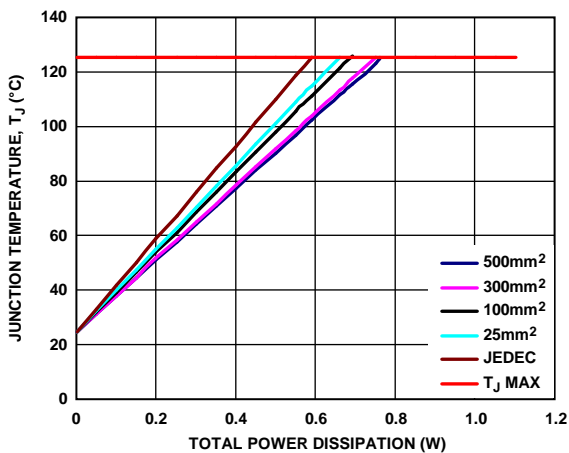

Figure 90. Junction Temperature vs. Total Power Dissipation for the 5-Lead TSOT,  $T_A = 25^\circ\text{C}$

**Thermal Characterization Parameter,  $\Psi_{JB}$**

When the board temperature is known, use the thermal characterization parameter,  $\Psi_{JB}$ , to estimate the junction temperature rise (see Figure 93 and Figure 94). Maximum junction temperature ( $T_J$ ) is calculated from the board temperature ( $T_B$ ) and power dissipation ( $P_D$ ) using the following formula:

$$T_J = T_B + (P_D \times \Psi_{JB}) \tag{6}$$

The typical value of  $\Psi_{JB}$  is 18.2°C/W for the 8-lead LFCSP package and 43°C/W for the 5-lead TSOT package.

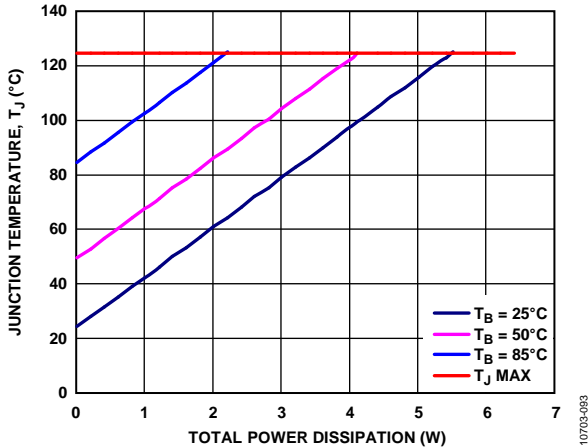

Figure 93. Junction Temperature vs. Total Power Dissipation for the 8-Lead LFCSP,  $T_A = 85^\circ\text{C}$

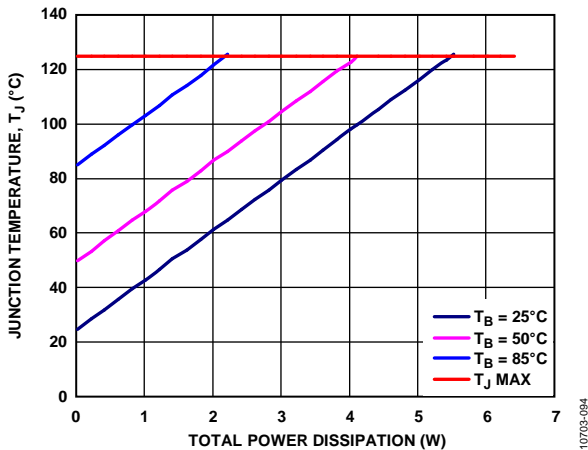

Figure 94. Junction Temperature vs. Total Power Dissipation for the 5-Lead TSOT,  $T_A = 85^\circ\text{C}$

**PCB LAYOUT CONSIDERATIONS**

Place the input capacitor as close as possible to the VIN and GND pins. Place the output capacitor as close as possible to the VOUT and GND pins. Use of 1206 or 0805 size capacitors and resistors achieves the smallest possible footprint solution on boards where area is limited.

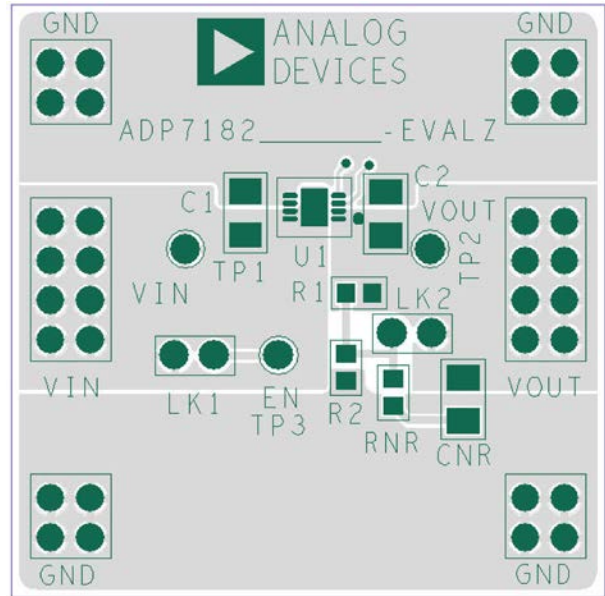

Figure 95. Example of the 8-Lead LFCSP PCB Layout

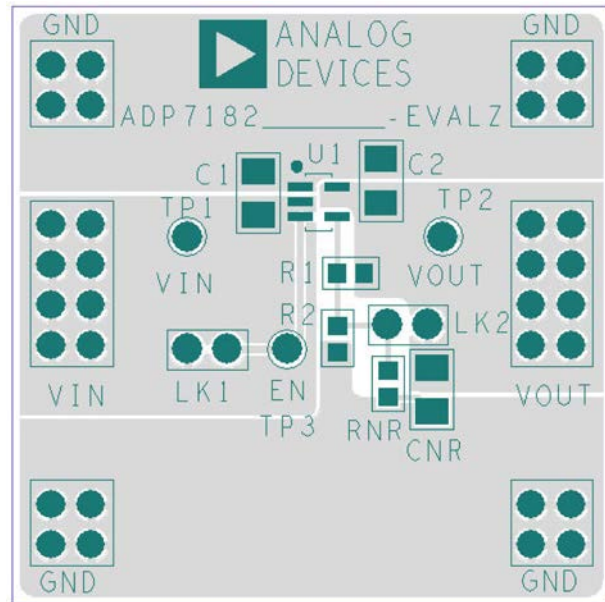
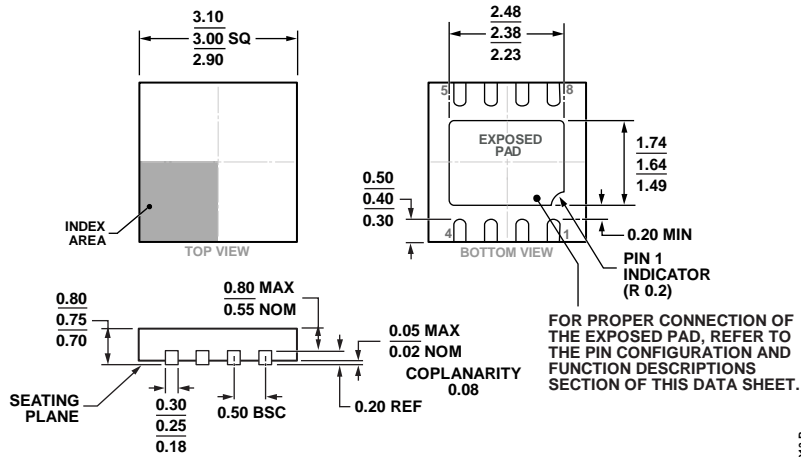

Figure 96. Example of the 5-Lead TSOT PCB Layout

OUTLINE DIMENSIONS



COMPLIANT TO JEDEC STANDARDS MO-229-WEED-4

Figure 97. 8-Lead Lead Frame Chip Scale Package [LFCSP\_WD]  
3 mm × 3 mm Body, Very Very Thin, Dual Lead  
(CP-8-5)

Dimensions shown in millimeters

02-05-2013-B

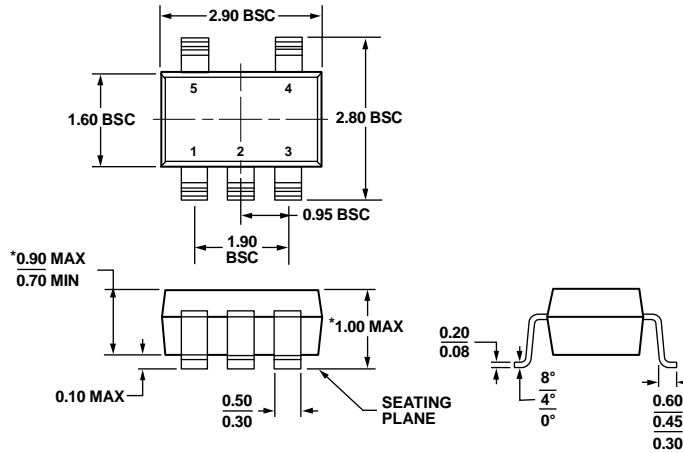

\*COMPLIANT TO JEDEC STANDARDS MO-193-AB WITH THE EXCEPTION OF PACKAGE HEIGHT AND THICKNESS.

Figure 98. 5-Lead Thin Small Outline Transistor Package [TSOT]  
(UJ-5)

Dimensions show in millimeters

100708-A

**ORDERING GUIDE**

Model <sup>1</sup>	Temperature Range	Output Voltage (V) <sup>2</sup>	Package Description	Package Option	Branding
ADP7182ACPZ-R7	-40°C to +125°C	Adjustable	8-Lead LFCSP_WD	CP-8-5	LN6
ADP7182ACPZ-5.0-R7	-40°C to +125°C	-5	8-Lead LFCSP_WD	CP-8-5	LN9
ADP7182AUJZ-R7	-40°C to +125°C	Adjustable	5-Lead TSOT	UJ-5	LN6
ADP7182AUJZ-1.8-R7	-40°C to +125°C	-1.8	5-Lead TSOT	UJ-5	LN1
ADP7182AUJZ-2.5-R7	-40°C to +125°C	-2.5	5-Lead TSOT	UJ-5	LN7
ADP7182AUJZ-3.0-R7	-40°C to +125°C	-3	5-Lead TSOT	UJ-5	LN2
ADP7182AUJZ-5.0-R7	-40°C to +125°C	-5	5-Lead TSOT	UJ-5	LN9
ADP7182UJ-EVALZ			Evaluation Board		
ADP7182CP-EVALZ			Evaluation Board		

<sup>1</sup> Z = RoHS Compliant Part.

<sup>2</sup> For additional voltage options, contact a local Analog Devices, Inc., sales or distribution representative.