

## PrevaLED Core AC – Non VDE

### Spot-, Down- and Wallmount Light Engines and Modules



#### Areas of application

- Spot lighting in shops
- Down- and wall lighting in offices, corridors, meeting rooms, workplaces
- Decorative and functional lighting in the hospitality industry

#### Product benefits

- Connect directly to 220...240 V AC mains voltage for class 1 luminaires
- No external driver required
- Enabling low cost and compact luminaire designs
- Simplified logistics as no external driver or special cables are required
- Enhanced safety thanks to protective cover glass and reversible thermal shutdown
- Easy to integrate thanks to compatibility with Zhaga book 3 heatsink and reflector
- Reduced luminaire cost thanks to cheaper light engine and less housing material
- Uniform Chip-On-Board technology with great homogeneity, no diffuser required

#### Product features

- LED light engine with integrated driver
- Light emitting surface, diameter, mounting holes positioning according to Zhaga Book 3
- Poke-in wire connection (no special connector required)
- Available with luminous flux: 800 lm, 2,000 lm
- System efficacy: up to 82 lm/W
- Color temperature: 2,700 K, 3,000 K, 3,500 K or 4,000 K
- Color rendering index  $R_a$ : typ. 83
- Maximum housing temperature: 80 °C at  $t_c$  point
- Initial color consistency: < 3 SDCM
- Lifetime (L70/B50): 40,000 h (temperature at  $t_r = 65$  °C)
- Power factor: 0.9



## Technical data

### Electrical data

Product description	Nominal voltage	Nominal current	Rated wattage	Type of current
LEP -2000-827-C-AC	230.00 V	0.13 A	26.20 W	AC
LEP -2000-830-C-AC	230.00 V	0.13 A	25.70 W	AC
LEP -2000-840-C-AC	230.00 V	0.13 A	24.40 W	AC
LEP -800-827-C-AC	230.00 V	0.06 A	14.00 W	AC
LEP -800-830-C-AC	230.00 V	0.06 A	13.10 W	AC
LEP -800-840-C-AC	230.00 V	0.06 A	12.60 W	AC

Product description	Power factor $\lambda$	Energy consumption
LEP -2000-827-C-AC	> 0.95	27 kWh/1000h
LEP -2000-830-C-AC	> 0.95	26 kWh/1000h
LEP -2000-840-C-AC	> 0.95	25 kWh/1000h
LEP -800-827-C-AC	> 0.95	15 kWh/1000h
LEP -800-830-C-AC	> 0.95	14 kWh/1000h
LEP -800-840-C-AC	> 0.95	13 kWh/1000h

### Light technical data

Product description	Nominal beam angle	Rated beam angle	Color temperature	Color rendering group
LEP -2000-827-C-AC	110.00 °	110.00 °	2700 K	1B
LEP -2000-830-C-AC	110.00 °	110.00 °	3000 K	1B
LEP -2000-840-C-AC	110.00 °	110.00 °	4000 K	1B
LEP -800-827-C-AC	110.00 °	110.00 °	2700 K	1B
LEP -800-830-C-AC	110.00 °	110.00 °	3000 K	1B
LEP -800-840-C-AC	110.00 °	110.00 °	4000 K	1B

Product description	Color rendering index Ra	Light color as per EN 12464-1	Total useful luminous flux	Nom. useful luminous flux 120°
LEP -2000-827-C-AC	>80	Warm White	2000 lm	1720 lm
LEP -2000-830-C-AC	>80	Warm White	2000 lm	1720 lm
LEP -2000-840-C-AC	>80	Cool White	2000 lm	1720 lm
LEP -800-827-C-AC	>80	Warm White	800 lm	688 lm
LEP -800-830-C-AC	>80	Warm White	800 lm	688 lm
LEP -800-840-C-AC	>80	Cool White	800 lm	688 lm

## Product family datasheet

Product description	Rated useful luminous flux 120°	Lumen main.fact.at end of nom.life time	Rated peak intensity	Luminous efficacy
LEP -2000-827-C-AC	1720 lm	0.70	770 cd	76 lm/W
LEP -2000-830-C-AC	1720 lm	0.70	770 cd	78 lm/W
LEP -2000-840-C-AC	1720 lm	0.70	770 cd	82 lm/W
LEP -800-827-C-AC	688 lm	0.70	310 cd	59 lm/W
LEP -800-830-C-AC	688 lm	0.70	310 cd	60 lm/W
LEP -800-840-C-AC	688 lm	0.70	310 cd	62 lm/W

Product description	Starting time	Warm-up time (60 %)	Standard deviation of color matching	Luminous flux
LEP -2000-827-C-AC	< 0.1 s	< 0.10 s	≤3 sdcn	
LEP -2000-830-C-AC	< 0.1 s	< 0.10 s	≤3 sdcn	
LEP -2000-840-C-AC	< 0.1 s	< 0.10 s	≤3 sdcn	2000 lm
LEP -800-827-C-AC	< 0.1 s	< 0.10 s	≤3 sdcn	800 lm
LEP -800-830-C-AC	< 0.1 s	< 0.10 s	≤3 sdcn	
LEP -800-840-C-AC	< 0.1 s	< 0.10 s	≤3 sdcn	

## Dimensions & weight

Product description	Diameter	Height	Rated height	Product weight
LEP -2000-827-C-AC	50.0 mm	9.3 mm	9.30 mm	21.50 g
LEP -2000-830-C-AC	50.0 mm	9.3 mm	9.30 mm	21.50 g
LEP -2000-840-C-AC	50.0 mm	9.3 mm	9.30 mm	21.50 g
LEP -800-827-C-AC	50.0 mm	9.3 mm	9.30 mm	21.50 g
LEP -800-830-C-AC	50.0 mm	9.3 mm	9.30 mm	21.50 g
LEP -800-840-C-AC	50.0 mm	9.3 mm	9.30 mm	21.50 g

## Produkt Strichzeichnungen (vermasst)

## Product family datasheet

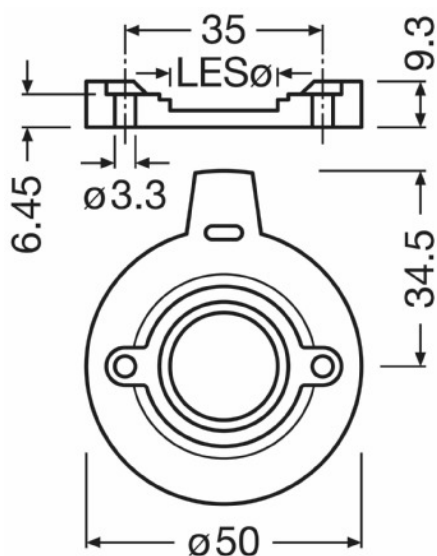

Product line drawing  
LEP -2000-827-C-AC | LEP -2000-830-C-AC | LEP -2000-840-C-AC

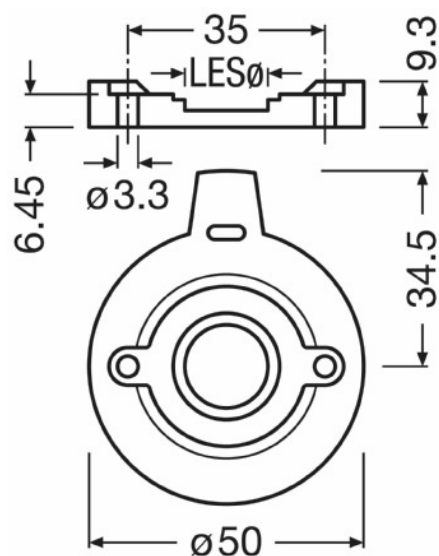

Product line drawing  
LEP -800-827-C-AC | LEP -800-830-C-AC | LEP -800-840-C-AC

## Temperatures

Product description	Maximum temperature at tc test point	Ambient temperature range
LEP -2000-827-C-AC	80 °C	0...+40 °C
LEP -2000-830-C-AC	80 °C	0...+40 °C
LEP -2000-840-C-AC	80 °C	0...+40 °C
LEP -800-827-C-AC	80 °C	0...+40 °C
LEP -800-830-C-AC	80 °C	0...+40 °C
LEP -800-840-C-AC	80 °C	0...+40 °C

## Lifespan

Product description	Lifespan	Nominal lamp life time	Rated lamp life time	Number of switching cycles
LEP -2000-827-C-AC	50000 h <sup>1)</sup>	50000 h	50000 h	500000
LEP -2000-830-C-AC	50000 h <sup>1)</sup>	50000 h	50000 h	500000
LEP -2000-840-C-AC	50000 h <sup>1)</sup>	50000 h	50000 h	500000
LEP -800-827-C-AC	50000 h <sup>1)</sup>	50000 h	50000 h	500000
LEP -800-830-C-AC	50000 h <sup>1)</sup>	50000 h	50000 h	500000

## Product family datasheet

Product description	Lifespan	Nominal lamp life time	Rated lamp life time	Number of switching cycles
LEP -800-840-C-AC	50000 h <sup>1)</sup>	50000 h	50000 h	500000

<sup>1)</sup> L70/B30 at 65 °C

### Capabilities

Product description	Dimmable
LEP -2000-827-C-AC	No
LEP -2000-830-C-AC	No
LEP -2000-840-C-AC	No
LEP -800-827-C-AC	No
LEP -800-830-C-AC	No
LEP -800-840-C-AC	No

### Certificates & standards

Product description	Energy efficiency class	Standards
LEP -2000-827-C-AC	A	acc. to EN 62031/acc. to EN 55015/acc. to EN 61000-3-2/acc. to EN 61000-3-3/acc. to EN 61547/acc. to EN 62471
LEP -2000-830-C-AC	A	acc. to EN 62031/acc. to EN 55015/acc. to EN 61000-3-2/acc. to EN 61000-3-3/acc. to EN 61547/acc. to EN 62471
LEP -2000-840-C-AC	A	acc. to EN 62031/acc. to EN 55015/acc. to EN 61000-3-2/acc. to EN 61000-3-3/acc. to EN 61547/acc. to EN 62471
LEP -800-827-C-AC	A	acc. to EN 62031/acc. to EN 55015/acc. to EN 61000-3-2/acc. to EN 61000-3-3/acc. to EN 61547/acc. to EN 62471
LEP -800-830-C-AC	A	acc. to EN 62031/acc. to EN 55015/acc. to EN 61000-3-2/acc. to EN 61000-3-3/acc. to EN 61547/acc. to EN 62471

## Product family datasheet

Product description	Energy efficiency class	Standards
LEP -800-840-C-AC	A	acc. to EN 62031/acc. to EN 55015/acc. to EN 61000-3-2/acc. to EN 61000-3-3/acc. to EN 61547/acc. to EN 62471

## Country specific categorizations

Product description
LEP -2000-827-C-AC
LEP -2000-830-C-AC
LEP -2000-840-C-AC
LEP -800-827-C-AC
LEP -800-830-C-AC
LEP -800-840-C-AC







## Application advice

For more detailed application information and graphics please see product datasheet.









## Sales and Technical Support

Sales and Technical Support [www.osram.com](http://www.osram.com)

## Download Data

File
 Product Family Datasheet PrevaLED Core AC G1 Technical Data Sheet_EN
 Declarations of conformity EC-Declaration of Conformity_PrevaLED Core AC
 Installation guide Application Guide PrevaLED Core AC (GB)
 CAD data PrevaLED Core AC 2000lm - Mechanical design.STEP
 CAD data 3-dim PrevaLED Core AC 2000lm - Mechanical design
 CAD data PDF PrevaLED Core AC 2000lm - 3D visualization
 Eulumdat PrevaLED LEP-2000-827-C-AC.LDT
Eulumdat

## Product family datasheet

	PrevaLED LEP-2000-830-C-AC.LDT
	Eulumdat PrevaLED LEP-2000-840-C-AC.LDT
	CAD data PrevaLED Core AC 800lm - Mechanical design.STEP
	CAD data 3-dim PrevaLED Core AC 800lm - Mechanical design
	CAD data PDF PrevaLED Core AC 800lm - 3D visualization
	Eulumdat PrevaLED LEP-800-827-C- AC.LDT
	Eulumdat PrevaLED LEP-800-830-C-AC.LDT
	Eulumdat PrevaLED LEP-800-840-C-AC.LDT

## Logistical Data

Product code	Product description	Packaging unit (Pieces/Unit)	Dimensions (height x width x length)	Volume	Gross weight
4008321849502	LEP -2000-827-C-AC	Shipping carton box 50	- x - x -		
4008321849533	LEP -2000-830-C-AC	Shipping carton box 50	- x - x -		
4008321849564	LEP -2000-840-C-AC	Shipping carton box 50	- x - x -		
4008321849595	LEP -800-827-C-AC	Shipping carton box 50	- x - x -		
4008321849441	LEP -800-830-C-AC	Shipping carton box 50	- x - x -		
4008321849472	LEP -800-840-C-AC	Shipping carton box 50	- x - x -		

The mentioned product code describes the smallest quantity unit which can be ordered. One shipping unit can contain one or more single products. When placing an order, for the quantity please enter single or multiples of a shipping unit.

## Disclaimer

Subject to change without notice. Errors and omission excepted. Always make sure to use the most recent release.