

## PrevaLED Cube

### Spot-, Down- and Wallmount Light Engines and Modules



#### Areas of application

- Suitable for diffuser and reflector luminaires
- Hospitality, hotels, restaurants
- Public and commercial buildings
- Offices
- Secondary rooms, garages, storerooms, cellars

#### Product benefits

- Low height for compact luminaire designs
- Near Lambertian light distribution at 110° beam angle for high quality of light
- Robust design for easy thermal management and long lifetime
- System guarantee in combination with OSRAM OPTOTRONIC control gear

#### Product features

- Consistent white light: < 3 SDCM
- Temperature at  $t_p$  point (according to IEC/PAS 62717): 70 °C
- $T_c$  temperature (according to IEC/PAS 62031): 100 °C
- Diameter of light emitting surface: 61 mm
- Light management and system guarantee available when used with OSRAM OPTOTRONIC
- Lifetime (L70/B50): 50,000 h (temperature at  $t_c$  point < 80 °C) acc. to IEC/PAS 62717
- Lifetime (L0/C10): 50,000 h (temperature at  $t_c$  point < 80 °C) according to IEC/PAS 62717
- Versions with different luminous flux and different color temperatures available
- Common mechanic and optical connection for standard heat sinks and reflectors



## Technical data

### Electrical data

Product description	Nominal voltage	Nominal current	Nominal wattage	Rated wattage
PL-CUBE -1100-830	34.00 V	0.35 A	11.8 W	11.80 W
PL-CUBE -1100-840	34.00 V	0.35 A	11.8 W	11.80 W
PL-CUBE -2000-830	40.00 V	0.50 A	19.8 W	19.80 W
PL-CUBE -2000-840	40.00 V	0.50 A	19.8 W	19.80 W
PL-CUBE -3000-830	44.00 V	0.70 A	30.3 W	30.30 W
PL-CUBE -3000-840	44.00 V	0.70 A	30.3 W	30.30 W

Product description	Type of current	Power factor $\lambda$	Energy consumption
PL-CUBE -1100-830	DC	1.00	12 kWh/1000h
PL-CUBE -1100-840	DC	1.00	12 kWh/1000h
PL-CUBE -2000-830	DC	1.00	20 kWh/1000h
PL-CUBE -2000-840	DC	1.00	20 kWh/1000h
PL-CUBE -3000-830	DC	1.00	30 kWh/1000h
PL-CUBE -3000-840	DC	1.00	30 kWh/1000h

### Light technical data

Product description	Nominal beam angle	Rated beam angle	Color temperature	Color rendering index Ra
PL-CUBE -1100-830	110.00 °	108.00 °	3000 K	≥80
PL-CUBE -1100-840	110.00 °	108.00 °	4000 K	≥80
PL-CUBE -2000-830	110.00 °	108.00 °	3000 K	≥80
PL-CUBE -2000-840	110.00 °	108.00 °	4000 K	≥80
PL-CUBE -3000-830	110.00 °	108.00 °	3000 K	≥80
PL-CUBE -3000-840	110.00 °	108.00 °	4000 K	≥80

Product description	Light color LED	Total useful luminous flux	Luminous flux	Nom. useful luminous flux 120°
PL-CUBE -1100-830	warm white	1100 lm	1100 lm	880 lm
PL-CUBE -1100-840	cool white	1100 lm	1100 lm	880 lm
PL-CUBE -2000-830	warm white	2000 lm	2000 lm	1600 lm
PL-CUBE -2000-840	cool white	2000 lm	2000 lm	1600 lm
PL-CUBE -3000-830	warm white	3000 lm	3000 lm	2400 lm
PL-CUBE -3000-840	cool white	3000 lm	3000 lm	2400 lm

## Product family datasheet

Product description	Rated useful luminous flux 120°	Lumen main.fact.at end of nom.life time	Rated peak intensity	Luminous efficacy
PL-CUBE -1100-830	925 lm	0.70	428 cd	99 lm/W
PL-CUBE -1100-840	999 lm	0.70	462 cd	109 lm/W
PL-CUBE -2000-830	1519 lm	0.70	702 cd	95 lm/W
PL-CUBE -2000-840	1642 lm	0.70	759 cd	104 lm/W
PL-CUBE -3000-830	2274 lm	0.70	1052 cd	93 lm/W
PL-CUBE -3000-840	2457 lm	0.70	1136 cd	102 lm/W

Product description	Starting time	Warm-up time (60 %)	Standard deviation of color matching
PL-CUBE -1100-830	0.0 s	0.00 s	≤3 sdcn
PL-CUBE -1100-840	0.0 s	0.00 s	≤3 sdcn
PL-CUBE -2000-830	0.0 s	0.00 s	≤3 sdcn
PL-CUBE -2000-840	0.0 s	0.00 s	≤3 sdcn
PL-CUBE -3000-830	0.0 s	0.00 s	≤3 sdcn
PL-CUBE -3000-840	0.0 s	0.00 s	≤3 sdcn

## Dimensions & weight

Product description	Rated height	Rated width	Construction length	Product weight
PL-CUBE -1100-830	21.00 mm	82.00 mm	83.0 mm	47.50 g
PL-CUBE -1100-840	21.00 mm	82.00 mm	83.0 mm	47.50 g
PL-CUBE -2000-830	21.00 mm	83.00 mm	83.0 mm	47.50 g
PL-CUBE -2000-840	21.00 mm	82.00 mm	83.0 mm	47.50 g
PL-CUBE -3000-830	21.00 mm	82.00 mm	83.0 mm	53.10 g
PL-CUBE -3000-840	21.00 mm	82.00 mm	83.0 mm	53.10 g

## Produkt Strichzeichnungen (vermasst)

## Product family datasheet

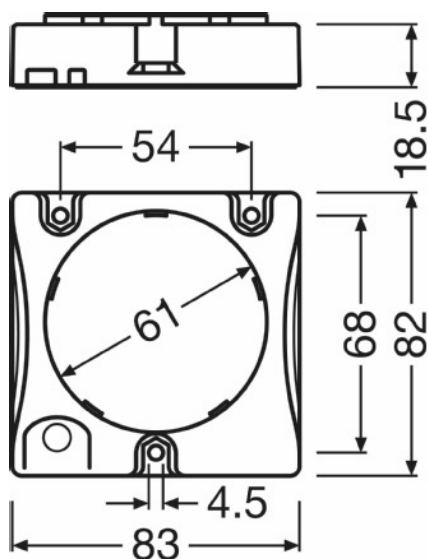

Product line drawing

PL-CUBE -1100-830 | PL-CUBE -1100-840 | PL-CUBE -2000-830 | PL-CUBE -2000-840 | PL-CUBE -3000-830

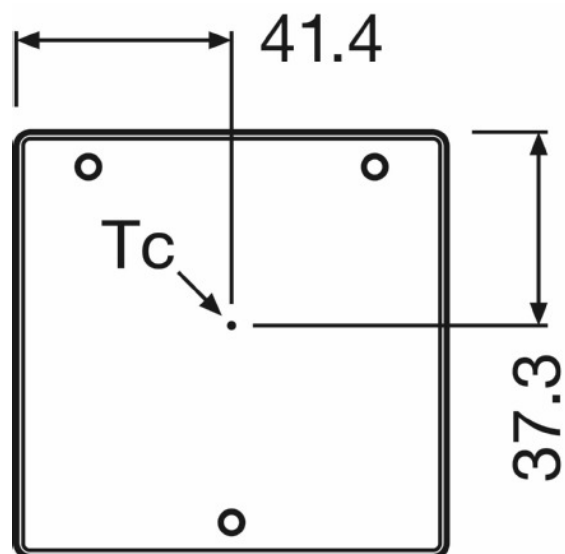

Product line drawing

PL-CUBE -3000-840

## Temperatures

Product description	Maximum temperature at tc test point	Ambient temperature range
PL-CUBE -1100-830	100 °C <sup>1)</sup>	-20...+50 °C
PL-CUBE -1100-840	100 °C <sup>1)</sup>	-20...+50 °C
PL-CUBE -2000-830	100 °C <sup>1)</sup>	-20...+50 °C
PL-CUBE -2000-840	100 °C <sup>1)</sup>	-20...+50 °C
PL-CUBE -3000-830	100 °C <sup>1)</sup>	-20...+50 °C
PL-CUBE -3000-840	100 °C <sup>1)</sup>	-20...+50 °C

<sup>1)</sup> Maximum at the Tc-point

## Lifespan

Product description	Lifespan	Nominal lamp life time	Rated lamp life time	Number of switching cycles
PL-CUBE -1100-830	50000 h <sup>1)</sup>	50000 h	50000 h	>25000
PL-CUBE -1100-840	50000 h <sup>1)</sup>	50000 h	50000 h	>25000
PL-CUBE -2000-830	50000 h <sup>1)</sup>	50000 h	50000 h	>25000
PL-CUBE -2000-840	50000 h <sup>1)</sup>	50000 h	50000 h	>25000

## Product family datasheet

Product description	Lifespan	Nominal lamp life time	Rated lamp life time	Number of switching cycles
PL-CUBE -3000-830	50000 h <sup>1)</sup>	50000 h	50000 h	>25000
PL-CUBE -3000-840	50000 h <sup>1)</sup>	50000 h	50000 h	>25000

<sup>1)</sup> L70/B50 at Tc 75 °C

### Capabilities

Product description	Dimmable
PL-CUBE -1100-830	Yes
PL-CUBE -1100-840	Yes
PL-CUBE -2000-830	Yes
PL-CUBE -2000-840	Yes
PL-CUBE -3000-830	Yes
PL-CUBE -3000-840	Yes

### Certificates & standards

Product description	Energy efficiency class	Standards
PL-CUBE -1100-830	A+	acc. to EN 55015/acc. to EN 61547/acc. to EN 62031/acc. to EN 62471
PL-CUBE -1100-840	A+	acc. to EN 55015/acc. to EN 61547/acc. to EN 62031/acc. to EN 62471
PL-CUBE -2000-830	A	acc. to EN 55015/acc. to EN 62031/acc. to EN 61547/acc. to EN 62471
PL-CUBE -2000-840	A+	acc. to EN 55015/acc. to EN 61547/acc. to EN 62031/acc. to EN 62471
PL-CUBE -3000-830	A	acc. to EN 55015/acc. to EN 61547/acc. to EN 62031/acc. to EN 62471
PL-CUBE -3000-840	A+	acc. to EN 55015/acc. to EN 61547/acc. to IEC 62031/acc. to IEC 62471

### Country specific categorizations

Product description
PL-CUBE -1100-830
PL-CUBE -1100-840

## Product family datasheet

### Product description

PL-CUBE -2000-830

PL-CUBE -2000-840

PL-CUBE -3000-830

PL-CUBE -3000-840







### Application advice

For more detailed application information and graphics please see product datasheet.

### Sales and Technical Support

Sales and Technical Support [www.osram.com](http://www.osram.com)

### Download Data

File
 Product Family Datasheet Family Datasheet: PrevaLED Cube G1
 Declarations of conformity EC-Declaration of Conformity PrevaLED Cube G1
 CAD data CAD PrevaLED Cube
 CAD data CAD PrevaLED Cube Parasolid
 CAD data CAD PrevaLED Cube
 CAD data PDF CAD Data PrevaLED Cube 3D
 Eulumdat EULUMDAT: PrevaLED Cube G1

### Logistical Data

Product code	Product description	Packaging unit (Pieces/Unit)	Dimensions (height x width x length)	Volume	Gross weight
4052899909588	PL-CUBE -1100-830	Shipping carton box 20	- x - x -		
4052899909601	PL-CUBE -1100-840	Shipping carton box 20	- x - x -		

## Product family datasheet

4052899909625	PL-CUBE -2000-830	Shipping carton box 20	57 mm x 400 mm x 482 mm	10.99 dm <sup>3</sup>	1450.00 g
4052899909649	PL-CUBE -2000-840	Shipping carton box 20	- x - x -		
4052899909663	PL-CUBE -3000-830	Shipping carton box 20	- x - x -		
4052899909687	PL-CUBE -3000-840	Shipping carton box 20	- x - x -		

The mentioned product code describes the smallest quantity unit which can be ordered. One shipping unit can contain one or more single products. When placing an order, for the quantity please enter single or multiples of a shipping unit.

---

### References / Links

---

For more information on the system guarantee and the terms and conditions of the guarantee visit

▶ [www.osram.com/system-guarantee](http://www.osram.com/system-guarantee)

---

### Disclaimer

---

Subject to change without notice. Errors and omission excepted. Always make sure to use the most recent release.