

## Surface Mount Ultrafast Plastic Rectifier

**DO-214AC (SMA)**

### FEATURES

- Low profile package
- Ideal for automated placement
- Glass passivated chip junction
- Ultrafast recovery times for high efficiency
- Low forward voltage, low power losses
- High forward surge capability
- Meets MSL level 1, per J-STD-020, LF maximum peak of 260 °C
- AEC-Q101 qualified
- Material categorization: For definitions of compliance please see [www.vishay.com/doc?99912](http://www.vishay.com/doc?99912)

**RoHS**  
COMPLIANT

| PRIMARY CHARACTERISTICS |                           |
|-------------------------|---------------------------|
| $I_{F(AV)}$             | 1.0 A                     |
| $V_{RRM}$               | 50 V, 100 V, 150 V, 200 V |
| $I_{FSM}$               | 30 A                      |
| $t_{rr}$                | 15 ns                     |
| $V_F$ at $I_F$          | 0.92 V                    |
| $T_J$ max.              | 150 °C                    |
| Package                 | DO-214AC (SMA)            |
| Diode variations        | Single die                |

### TYPICAL APPLICATIONS

For use in high frequency rectification and freewheeling application in switching mode converters and inverters for consumer, computer, automotive and telecommunication.

### MECHANICAL DATA

**Case:** DO-214AC (SMA)

Molding compound meets UL 94 V-0 flammability rating

Base P/N-E3 - RoHS-compliant, commercial grade

Base P/NHE3 - RoHS-compliant, AEC-Q101 qualified

Base P/NHE3\_X - RoHS-compliant and AEC-Q101 qualified ("\_X" denotes revision code e.g. A, B, ....)

**Terminals:** Matte tin plated leads, solderable per J-STD-002 and JESD 22-B102

E3 suffix meets JESD 201 class 2 whisker test, HE3 suffix meets JESD 201 class 2 whisker test

**Polarity:** Color band denotes cathode end

| MAXIMUM RATINGS ( $T_A = 25\text{ °C}$ unless otherwise noted)                     |                |             |      |      |      |      |
|--|----------------|-------------|------|------|------|------|
| PARAMETER  | SYMBOL         | ES1A        | ES1B | ES1C | ES1D | UNIT |
| Device marking code  |                | EA          | EB   | EC   | ED   |      |
| Maximum repetitive peak reverse voltage  | $V_{RRM}$      | 50          | 100  | 150  | 200  | V    |
| Maximum RMS voltage  | $V_{RMS}$      | 35          | 70   | 105  | 140  | V    |
| Maximum DC blocking voltage  | $V_{DC}$       | 50          | 100  | 150  | 200  | V    |
| Maximum average forward rectified current (fig. 1)                                 | $I_{F(AV)}$    | 1.0         |      |      |      | A    |
| Peak forward surge current 8.3 ms single half sine-wave superimposed on rated load | $I_{FSM}$      | 30          |      |      |      | A    |
| Operating junction and storage temperature range                                   | $T_J, T_{STG}$ | -55 to +150 |      |      |      | °C   |



| ELECTRICAL CHARACTERISTICS ( $T_A = 25\text{ }^\circ\text{C}$ unless otherwise noted) |  |             |                                   |      |               |
|---|--|-------------|-----------------------------------|------|---------------|
| PARAMETER   | TEST CONDITIONS  | SYMBOL      | VALUE                             | UNIT |               |
| Maximum instantaneous forward voltage   | $I_F = 0.6\text{ A}$   | $V_F^{(1)}$ | 0.865                             | V    |               |
|   | $I_F = 1.0\text{ A}$   | $V_F$       | 0.920                             |      |               |
| Maximum DC reverse current at rated DC blocking voltage                               |  | $I_R$       | $T_A = 25\text{ }^\circ\text{C}$  | 5.0  | $\mu\text{A}$ |
|   |  |             | $T_A = 100\text{ }^\circ\text{C}$ | 100  |               |
| Maximum reverse recovery time   | $I_F = 0.5\text{ A}, I_R = 1.0\text{ A}, I_{rr} = 0.25\text{ A}$                               | $t_{rr}$    | 15                                | ns   |               |
| Maximum reverse recovery time   | $I_F = 0.6\text{ A}, V_R = 30\text{ V}, dI/dt = 50\text{ A}/\mu\text{s}, I_{rr} = 10\% I_{RM}$ | $t_{rr}$    | $T_J = 25\text{ }^\circ\text{C}$  | 25   | ns            |
|   |  |             | $T_J = 100\text{ }^\circ\text{C}$ | 35   |               |
| Maximum stored charge   | $I_F = 0.6\text{ A}, V_R = 30\text{ V}, dI/dt = 50\text{ A}/\mu\text{s}, I_{rr} = 10\% I_{RM}$ | $Q_{rr}$    | $T_J = 25\text{ }^\circ\text{C}$  | 10   | nC            |
|   |  |             | $T_J = 100\text{ }^\circ\text{C}$ | 25   |               |
| Typical junction capacitance  | 4.0 V, 1 MHz   | $C_J$       | 10                                | pF   |               |

**Note**(1) Pulse test: 300  $\mu\text{s}$  pulse width, 1 % duty cycle

| THERMAL CHARACTERISTICS ( $T_A = 25\text{ }^\circ\text{C}$ unless otherwise noted) |                       |      |      |      |      |                           |
|--|-----------------------|------|------|------|------|---------------------------|
| PARAMETER  | SYMBOL                | ES1A | ES1B | ES1C | ES1D | UNIT                      |
| Typical thermal resistance   | $R_{\theta JA}^{(1)}$ | 85   |      |      |      | $^\circ\text{C}/\text{W}$ |
|  | $R_{\theta JL}^{(1)}$ | 35   |      |      |      |                           |

**Note**

(1) Units mounted on PCB 5.0 mm x 5.0 mm (0.013 mm thick) land areas

| ORDERING INFORMATION (Example) |                 |                        |               |                                    |
|--------------------------------|-----------------|------------------------|---------------|------------------------------------|
| PREFERRED P/N                  | UNIT WEIGHT (g) | PREFERRED PACKAGE CODE | BASE QUANTITY | DELIVERY MODE                      |
| ES1D-E3/61T                    | 0.064           | 61T                    | 1800          | 7" diameter plastic tape and reel  |
| ES1D-E3/5AT                    | 0.064           | 5AT                    | 7500          | 13" diameter plastic tape and reel |
| ES1DHE3/61T <sup>(1)</sup>     | 0.064           | 61T                    | 1800          | 7" diameter plastic tape and reel  |
| ES1DHE3/5AT <sup>(1)</sup>     | 0.064           | 5AT                    | 7500          | 13" diameter plastic tape and reel |
| ES1DHE3_A/H <sup>(1)</sup>     | 0.064           | H                      | 1800          | 7" diameter plastic tape and reel  |
| ES1DHE3_A/I <sup>(1)</sup>     | 0.064           | I                      | 7500          | 13" diameter plastic tape and reel |

**Note**

(1) AEC\_Q101 qualified

## RATINGS AND CHARACTERISTICS CURVES ( $T_A = 25\text{ }^\circ\text{C}$ unless otherwise noted)

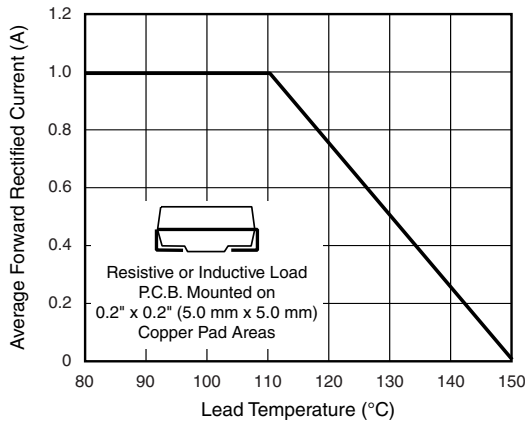

Fig. 1 - Maximum Forward Current Derating Curve

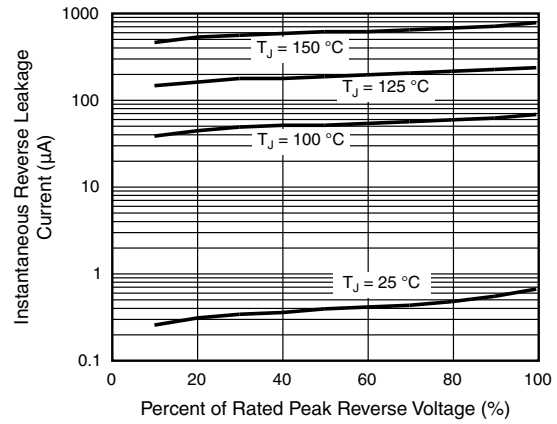

Fig. 4 - Typical Reverse Leakage Characteristics

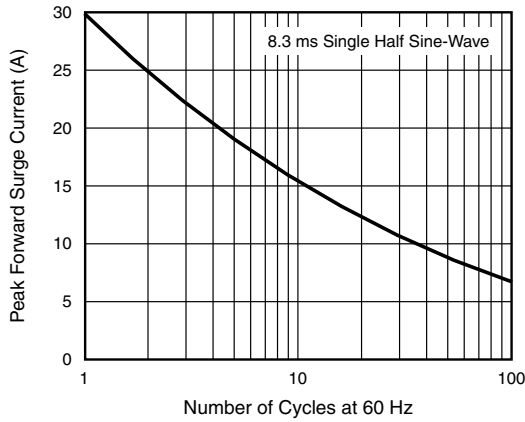

Fig. 2 - Maximum Non-Repetitive Peak Forward Surge Current

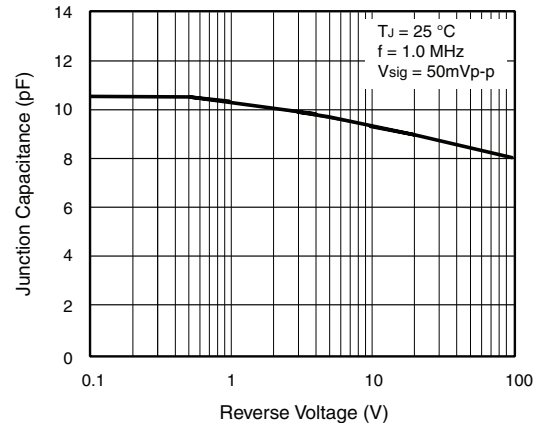

Fig. 5 - Typical Junction Capacitance

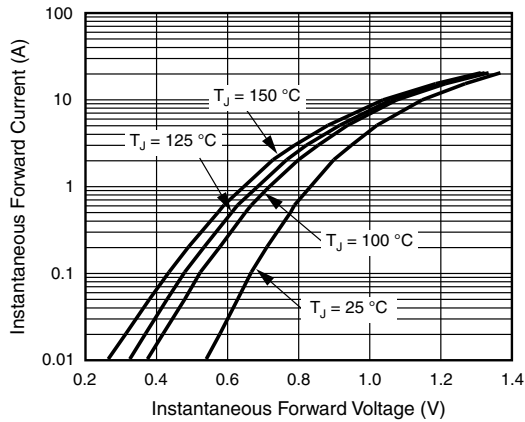

Fig. 3 - Typical Instantaneous Forward Characteristics

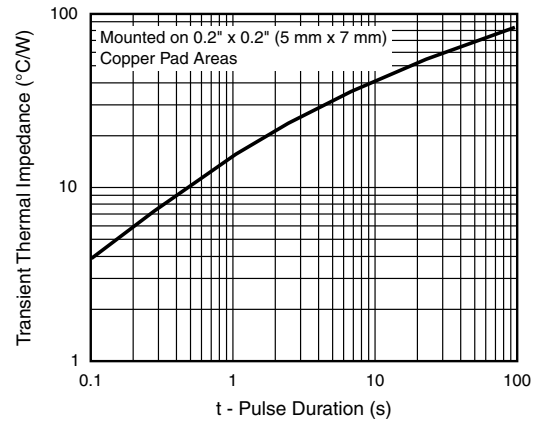
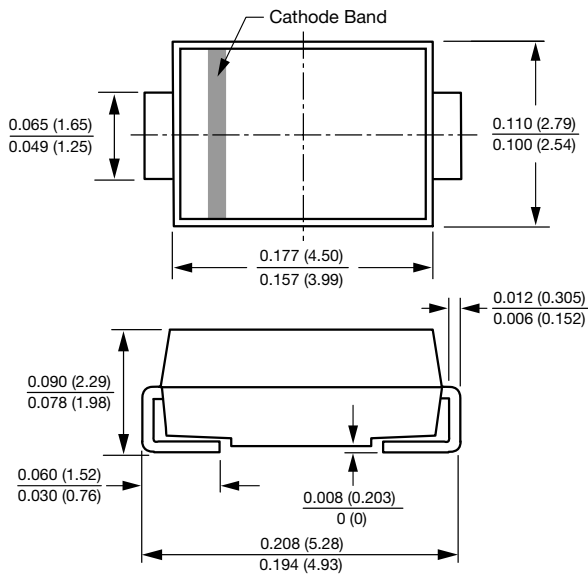

Fig. 6 - Typical Thermal Impedance



### PACKAGE OUTLINE DIMENSIONS in inches (millimeters)

#### DO-214AC (SMA)



#### Mounting Pad Layout

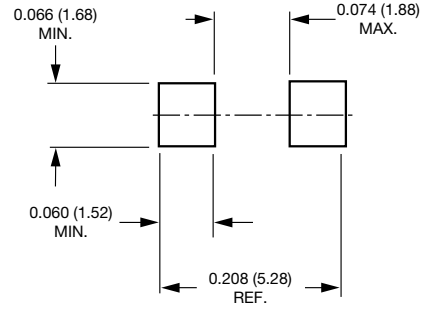



## Disclaimer

ALL PRODUCT, PRODUCT SPECIFICATIONS AND DATA ARE SUBJECT TO CHANGE WITHOUT NOTICE TO IMPROVE RELIABILITY, FUNCTION OR DESIGN OR OTHERWISE.

Vishay Intertechnology, Inc., its affiliates, agents, and employees, and all persons acting on its or their behalf (collectively, "Vishay"), disclaim any and all liability for any errors, inaccuracies or incompleteness contained in any datasheet or in any other disclosure relating to any product.

Vishay makes no warranty, representation or guarantee regarding the suitability of the products for any particular purpose or the continuing production of any product. To the maximum extent permitted by applicable law, Vishay disclaims (i) any and all liability arising out of the application or use of any product, (ii) any and all liability, including without limitation special, consequential or incidental damages, and (iii) any and all implied warranties, including warranties of fitness for particular purpose, non-infringement and merchantability.

Statements regarding the suitability of products for certain types of applications are based on Vishay's knowledge of typical requirements that are often placed on Vishay products in generic applications. Such statements are not binding statements about the suitability of products for a particular application. It is the customer's responsibility to validate that a particular product with the properties described in the product specification is suitable for use in a particular application. Parameters provided in datasheets and/or specifications may vary in different applications and performance may vary over time. All operating parameters, including typical parameters, must be validated for each customer application by the customer's technical experts. Product specifications do not expand or otherwise modify Vishay's terms and conditions of purchase, including but not limited to the warranty expressed therein.

Except as expressly indicated in writing, Vishay products are not designed for use in medical, life-saving, or life-sustaining applications or for any other application in which the failure of the Vishay product could result in personal injury or death. Customers using or selling Vishay products not expressly indicated for use in such applications do so at their own risk. Please contact authorized Vishay personnel to obtain written terms and conditions regarding products designed for such applications.

No license, express or implied, by estoppel or otherwise, to any intellectual property rights is granted by this document or by any conduct of Vishay. Product names and markings noted herein may be trademarks of their respective owners.

## Material Category Policy

**Vishay Intertechnology, Inc. hereby certifies that all its products that are identified as RoHS-Compliant fulfill the definitions and restrictions defined under Directive 2011/65/EU of The European Parliament and of the Council of June 8, 2011 on the restriction of the use of certain hazardous substances in electrical and electronic equipment (EEE) - recast, unless otherwise specified as non-compliant.**

**Please note that some Vishay documentation may still make reference to RoHS Directive 2002/95/EC. We confirm that all the products identified as being compliant to Directive 2002/95/EC conform to Directive 2011/65/EU.**

**Vishay Intertechnology, Inc. hereby certifies that all its products that are identified as Halogen-Free follow Halogen-Free requirements as per JEDEC JS709A standards. Please note that some Vishay documentation may still make reference to the IEC 61249-2-21 definition. We confirm that all the products identified as being compliant to IEC 61249-2-21 conform to JEDEC JS709A standards.**