

# Dust Proof Snap Action Switch D2FD



## Ultra Subminiature, Dust Proof Snap Action Switch

- Dust proof construction, meets IEC IP6X requirements.
- Models available that switch 2 A loads (general-purpose) or 0.1 A loads (microvoltage/microcurrent)
- Available with Solder or PCB terminals.
- RoHS Compliant.



**NEW**

## Ordering Information

Actuator	Terminal type	Model	
		Rating	
		2 A (General Purpose)	0.1 A (Microload)
Pin plunger 	Solder	D2FD-2L0-1H	D2FD-01L0-1H
	PCB	D2FD-2L0-1T	D2FD-01L0-1T
Hinge lever 	Solder	D2FD-2L1-1H	D2FD-01L1-1H
	PCB	D2FD-2L1-1T	D2FD-01L1-1T
Simulated roller lever (R2.5) 	Solder	D2FD-2L30-1H	D2FD-01L30-1H
	PCB	D2FD-2L30-1T	D2FD-01L30-1T

## Model Number Legend

D2FD-      -1    
           1 2 3

**1. Ratings**

- 2: 2A at 125 VAC / 30 VDC
- 01: 0.1 A at 125 VAC / 30 VDC

**2. Actuator**

- L0: Pin plunger
- L1: Hinge lever
- L30: Simulated roller lever

**3. Terminals**

- H: Solder terminals
- T: PCB terminals

# Specifications

## ■ Characteristics

Operating speed	1 to 500 mm/second
Operating frequency	Mechanical: 120 operations per minute max. Electrical: 20 operations per minute max.
Contact resistance	General Purpose models: 30 mΩ max. Microload models: 100 mΩ max.
Insulation resistance	100 MΩ min. at 500 VDC
Dielectric strength (See note 2)	600 VAC 50/60 Hz for 1 minute between terminals of the same polarity 1,500 VAC, 50/60 Hz for 1 minute between current-carrying metal parts and ground, and between each terminal and non-current-carrying metal parts
Vibration resistance (See note 3)	Malfunction: 10 to 55 Hz, 1.5 mm double amplitude
Shock resistance (See note 3)	Destruction: 1,000 m/s <sup>2</sup> (approx. 100G) max. Malfunction: 300 m/s <sup>2</sup> (approx. 30 g min.) max.
Degree of protection	IEC IP6X
Ambient operating temperature	-20° to 70°C (at 60% RH) with no icing
Ambient operating Humidity	85% max. (for 5° to 35°C)
Service life (Consult Omron for test conditions)	Mechanical: 300,000 operations min. at 60 operations/minute. Electrical: 30,000 operations min. at 20 operations/minute. (General Purpose models) 100,000 operations min. at 20 operations/minute. (Microload models)
Weight	Approx. 0.7 g (pin plunger models, PCB terminal models)

- Note:**
1. Data shown are of initial value.
  2. The dielectric strength shown in the table indicates a value for models with a separator.
  3. For pin plunger models, the values are measured at the free position and total travel position. For the lever models, they are measured at the total travel position. Contact opening or closing time is within 1 ms.

## ■ Ratings

Rated Voltage	Resistive load	
	D2FD-2 models	D2FD-01 models
125 VAC	2 A	0.1 A
30 VDC	2 A	0.1 A

- Note:**
1. When using an inductive load or motor load, consult OMRON.
  2. The ratings apply under the following test conditions: Ambient Temperature = 20±2°C, Ambient Humidity = 65±5%, Operating frequency = 20 operations/min.

## ■ Contact Specifications

Item	D2FD-2	D2FD-01
Specification	Crossbar	
Material	Silver alloy	Gold alloy
Gap (Standard value)	0.25 mm	
Minimum Applicable Load (See note)	100 mA at 5 VDC	1 mA at 5VDC

**Note:** Minimum applicable loads are indicated by N standard reference values. This value represents the failure rate at a 60% ( $\lambda_{60}$ ) reliability level (JIS C5003).

The equation  $\lambda_{60}=0.5 \times 10^{-6}/\text{operations}$  indicates that a failure rate of 1/2,000,000 operations can be expected at a reliability level of 60%.

# Engineering Data

## ■ Mounting

All switches may be panel mounted using M2.3 mounting screws with plane washers or spring washers to securely mount the switch. Tighten the screws to a torque of 0.20 to 0.29 N·m (2.0 to 2.9 kgf·cm). Exceeding the specified torque may result in deterioration or damage of the seal.

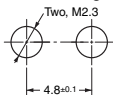

Use of molded components is recommended for mounting purposes

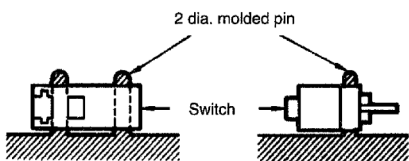

## ■ PCB Layout (reference)

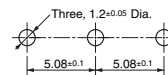

## ■ Structure

### Contact Form (SPDT)

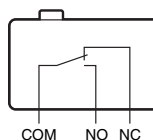

# Dimensions

## ■ Terminals

Note: Unless otherwise specified, all units are in millimeters and a tolerance of ±0.4 mm applies to all dimensions

### Solder terminals

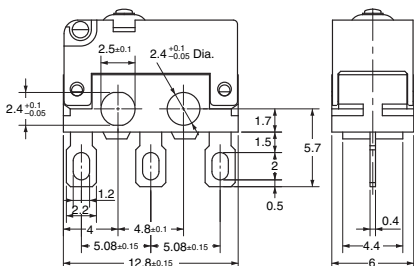

### PCB terminals

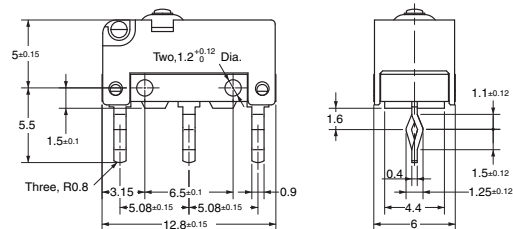

## ■ Dimensions and Operating Characteristics

- Note:** 1. Unless otherwise specified, all units are in millimeters and a tolerance of  $\pm 0.4$  mm applies to all dimensions  
 2. Omitted dimensions are the same as pin plunger type  
 3. The following illustrations and dimensions are for models with solder terminals. Refer to "Terminals" for models with PCB terminals  
 4. The operating characteristics are for operation in the A direction(↓)

### Pin Plunger Models

D2FD-□L0-1H  
 D2FD-□L0-1T

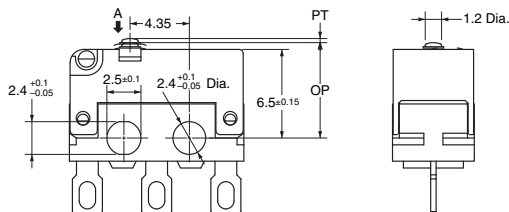
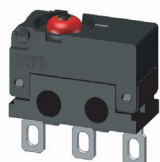

Characteristics	D2FD-□L0-1H D2FD-□L0-1T
OF max.	204 gf
RF min.	25 gf
PT max.	0.6 mm
OT min.	0.25 mm
MD max.	0.12 mm
OP	7.0 $\pm$ 0.2 mm (-1H) 7.0 $\pm$ 0.3 mm (-1T)
FP max.	—

### Hinge Lever

D2FD-□L1-1H  
 D2FD-□L1-1T

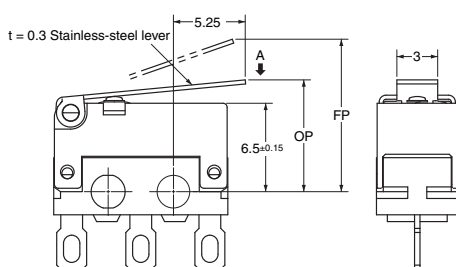
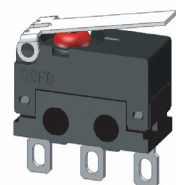

Characteristics	D2FD-□L1-1H D2FD-□L1-1T
OF max.	66 gf
RF min.	5 gf
PT max.	—
OT min.	0.5 mm
MD max.	0.5 mm
OP	8.3 $\pm$ 1.0 mm (-1H) 8.3 $\pm$ 1.2 mm (-1T)
FP max.	11.3 mm

### Simulated Roller Level (R2.5)

D2FD-□L30-1H  
 D2FD-□L30-1T

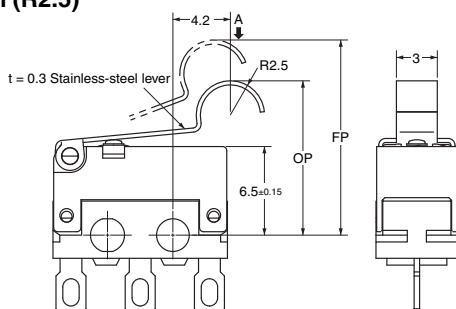
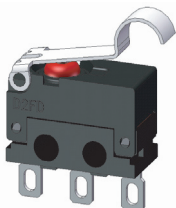

Characteristics	D2FD-□L30-1H D2FD-□L30-1T
OF max.	66 gf
RF min.	5 gf
PT max.	—
OT min.	0.5 mm
MD max.	0.5 mm
OP	11.3 $\pm$ 1.0 mm (-1H) 11.3 $\pm$ 1.2 mm (-1T)
FP max.	14.3 mm

# Precautions

Be sure to read the precautions and information common to all Snap Action and Detection Switches, contained in the Technical User's Guide, "Snap Action Switches, Technical Information" for correct use.

## ■ Cautions

### Degree of Protection

Do not use the switch in an environment that is exposed to water. The degree of protection is IP6X and the protection against water is not defined.

Prevent the switch from coming into contact with oil and chemicals. Otherwise, damage to or deterioration of the switch materials may result.

Do not use the switch in areas where it is exposed to silicon adhesives, oil, or grease, otherwise faulty contact may result due to the generation of silicon oxide.

The environment-resistant performance of the switch differs depending on the operating loads, ambient atmospheres, installation conditions, etc. Please perform an operating test of the switch in advance under actual usage conditions.

### Terminal Connection

When soldering a lead wire to the terminal, first insert the lead wire conductor into the terminal hole and then perform soldering.

Make sure that the capacity of the soldering iron is 30 W maximum and that the temperature of the soldering tip is approximately 300 °C. (350 °C maximum.) Complete soldering within 3 s. After soldering, do not apply external force to the soldered area for about 1 minute.

Using a switch with improper soldering may result in abnormal heating, possibly resulting in a burn.

Applying the soldering iron for more than 3 s or using an iron that is rated for more than 30 W may deteriorate the switch characteristics.

When using automatic soldering baths, we recommend soldering at  $260 \pm 5 \text{ }^\circ\text{C}$  within 5 seconds. Make sure that the liquid surface of the solder does not flow over the edge of the board.

## ■ Correct Use

### Mounting

Turn OFF the power supply before mounting or removing the switch, wiring the switch, or performing maintenance or inspection. Failure to do so may result in electric shock or burning.

Mount the switch onto a flat surface. Mounting on an uneven surface may cause deformation of the switch, resulting in faulty operation or breakage of the housing.

Allow sufficient insulation distance between terminals, terminal traces and between terminals and ground.

### Operating Body

Use an operating body with low frictional resistance and of a shape that will not interfere with the sealing rubber, otherwise the plunger may be damaged or the seal may deteriorate. With the pin plunger models, set the switch so that the plunger can be actuated from directly above. Since the plunger is covered with a rubber cap, applying a force from lateral directions may cause damage to the plunger or reduction in the sealing capability.

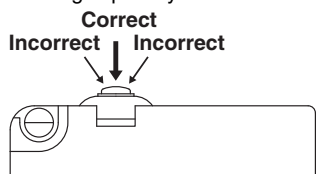

### Handling

Do not handle the switch in a way that may cause damage to the sealing rubber.

When handling the switch, ensure that uneven pressure or, as shown in the following diagram, pressure in a direction other than the operating direction, is not applied to the actuator. Otherwise the actuator or switch may be damaged and life expectancy will be reduced.

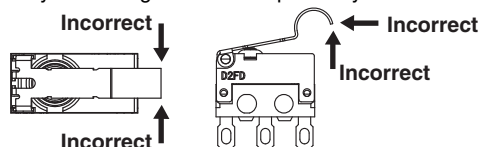

### Using Microloads

Using a model for ordinary loads to switch microloads may result in faulty operation. Instead, use the models that are designed for microloads and that operate in the following range;

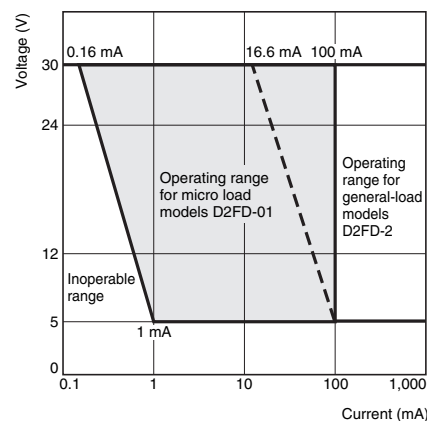

However, even when using microload models within the operating range shown above, if inrush current or inductive voltage spikes occur when the contact is opened or closed, it may increase contact wear and so decrease the service life. Therefore, insert a contact protection circuit where necessary.

All sales are subject to Omron Electronic Components LLC standard terms and conditions of sale, which can be found at [http://www.components.omron.com/components/web/webfiles.nsf/sales\\_terms.html](http://www.components.omron.com/components/web/webfiles.nsf/sales_terms.html)

**ALL DIMENSIONS SHOWN ARE IN MILLIMETERS.**  
To convert millimeters into inches, multiply by 0.03937. To convert grams into ounces, multiply by 0.03527.

---

**OMRON**<sup>®</sup>

**OMRON ELECTRONIC  
COMPONENTS LLC**

55 E. Commerce Drive, Suite B  
Schaumburg, IL 60173

**847-882-2288**

**OMRON ON-LINE**

Global - <http://www.omron.com>

USA - <http://www.components.omron.com>

Cat. No. B119-E-01

08/12

Specifications subject to change without notice

Printed in USA