

XPSMC16ZP

safety controller XPS-MC - 24 V DC - 16 input - 32 LEDs signalling

Main

Commercial Status	Commercialised
Range of product	Preventa Safety automation
Product or component type	Configurable safety controller
Safety module name	XPSMC
Safety use category	SIL 3 maximum conforming to IEC 61508 PLE maximum conforming to EN/ISO 13849-1 Category 4 maximum conforming to EN 954-1/EN/ISO 13849-1
Type of start	Configurable
Standards	EN 1760-1/ISO 13856-1 EN 574/ISO 13851 EN 954-1/EN/ISO 13849-1 EN/IEC 60204-1 EN/IEC 60947-5-1 EN/IEC 61496-1 IEC 61508
Product certifications	CSA TÜV UL
[Us] rated supply voltage	24 V DC - 20...20 %
Number of inputs	16
Communication port protocol	Profibus with 1 SUB-D 9-pin female port(s), serial link, transmission rate: 12 Mbps Modbus with 1 RJ45 port(s), serial link, transmission rate: 1200 bps, 2400 bps, 4800 bps, 9600 bps or 19200 bps
Safety level	Can reach SIL 3 conforming to IEC 61508 Can reach PL e/category 4 conforming to EN 954-1/EN/ISO 13849-1

Complementary

Function of module	Two-hand control (category 3) conforming to EN 574/ISO 13851 Light curtain monitoring (category 4) conforming to EN/IEC 61496 Zero speed detection Shaft/Chain breaking monitor Safety time delays Safety mat monitoring Position selector Muting function of light curtains Monitoring safety stop at top dead centre on eccentric press Magnetic switch monitoring Hydraulic press Guard monitoring with 1 or 2 limit switches Guard monitoring for injection presses and blowing machines Foot switch monitoring Enabling switch monitoring, 2 or 3 contacts Emergency stop monitoring, with or without time delay, 1 or 2-channel wiring Eccentric press Dynamic monitoring of hydraulic valves on linear presses
Synchronisation time between inputs	Depending on configuration selected
Power consumption	12 W
Input protection type	External fuse 16 A
[Uc] control circuit voltage	28.8 V
Line resistance	100 Ohm, cable length: <= 2000 m
Output type	Solid state, 6 circuit(s), volt-free 2 relays, 2 NO contacts (4 NO total) circuit(s)

Breaking capacity	C300: inrush 1800 VA AC-15 for relay output C300: holding 180 VA AC-15 for relay output
Breaking capacity	1.5 A/24 V - L/R = 50 ms, DC-13 for relay output 2 A/24 V for static output circuit
Output thermal current	6 A for 1 output and 2 A for the other for relay output 4 A for both outputs simultaneously
[I _{th}] conventional free air thermal current	<= 6.5 A for static output circuit <= 16 A for relay output
Associated fuse rating	6 A fast blow for relay output 4 A gL for relay output 16 A gL for power supply
Minimum output current	10 mA for relay output
Minimum output voltage	17 V for relay output
Response time	Configurable : 20 ms or 30 ms with software XPSMCWIN
[U _i] rated insulation voltage	300 V, degree of pollution 2 conforming to IEC 60647-5-1, DIN VDE 0110 part 1
[U _{imp}] rated impulse withstand voltage	4 kV overvoltage category III conforming to IEC 60647-5-1, DIN VDE 0110 part 1
Method of access	Slave
Exchange size	14 words
Number of addresses	1...247 for Modbus 1...125 for Profibus
Parity	Odd for Modbus No for Modbus Even for Modbus
Data format	RTU (Remote Terminal Unit) mode 2 stop bits without parity 1 stop bit even or odd 1 start bit/8 data bits
Supported modbus function	03: information and errors 02: 32-bit input data/8-bit output data 01: 8-bit output data/32-bit input data
Local signalling	32 LEDs
Mounting support	Mounting plate
Depth	153 mm
Height	151.5 mm
Width	74 mm
Product weight	0.82 kg

Environment

IP degree of protection	IP20 conforming to EN/IEC 60529
Ambient air temperature for operation	-10...55 °C
Ambient air temperature for storage	-25...85 °C

Contractual warranty

Period	18 months
--------	-----------

Dimensions

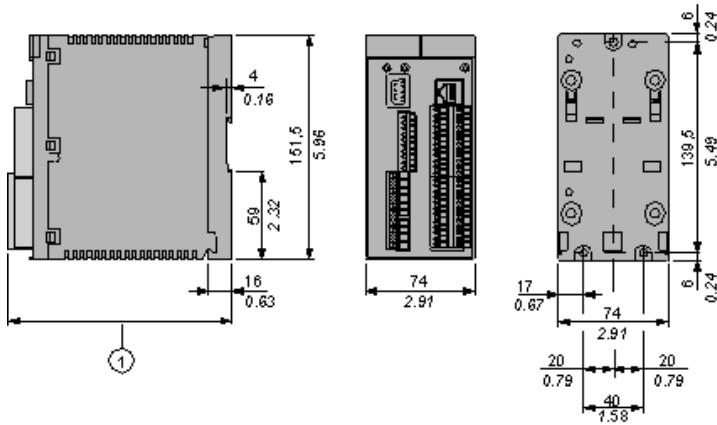

- 1 When using XPSMCTS• connectors this dimension is 153 mm (6.02 in)
When using XPSMCTC• connectors this dimension is 151,5 mm (5.96 in)

Installation

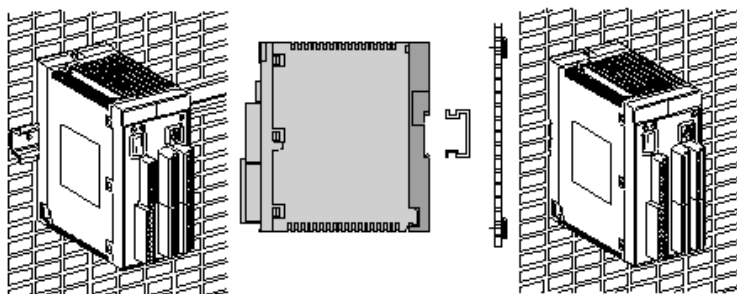

Metal adaptor for fixing on metal: DIN rail 35 mm/1.38 in.

Wiring Diagrams

Refer to the Instruction Sheet

To download the instruction sheet, follow below procedure:

The screenshot shows the product page for XPSAC5121. At the top, there is a product image and the text: **XPSAC5121**
module XPSAC - Emergency stop - 24 V AC DC
Below this is a link: [Download XPSAC5121 product datasheet](#)

The 'Download & Documents' section is titled 'Download & Documents 1 to 3 of 3 (Total: -1)'. It contains three categories:



- Instruction sheet**: A table with one row: 'XPSAC... Safety module for emergency stop and switch monitoring', 'English 2012-07-04', and 'pdf (29;)'.
- Image of product**: A table with one row: 'Emergency stop and switch monitoring', '2010-11-10', and '{Select :}'.
- Certificate**: A table with one row: 'Russian certificate', 'English 2010-07-07', and 'pdf (60;)'.



On the left side, there is a 'Discover XPSAC5121 by' menu with the following items: Characteristics, Dimensions Drawings, Connections and Schema, Technical Description, and **Download & Documents** (highlighted with a red box). A line connects this menu item to a circled '1' below it.

A line connects the 'Instruction sheet' document in the table to a circled '2' below it.

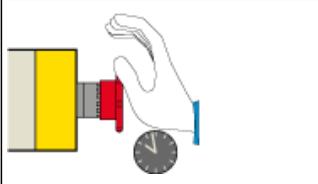
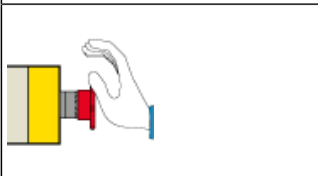
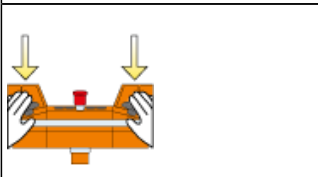
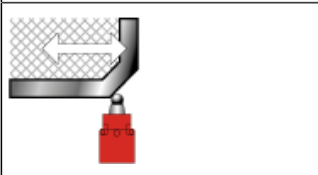
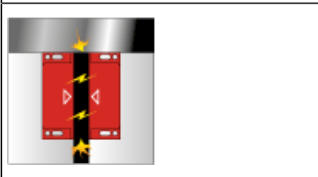
- 1 Click on Download & Documents.
- 2 Click on Instruction sheet.

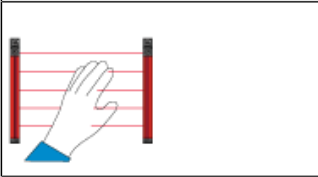
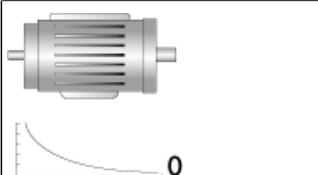
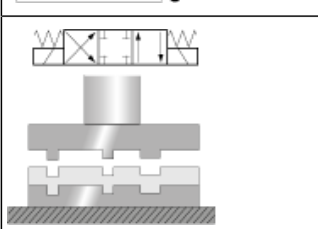
Safety Functions

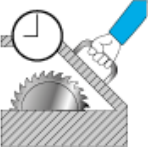
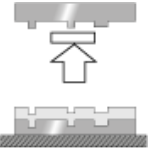
	<ul style="list-style-type: none"> • Emergency stop monitoring with time delay: <ul style="list-style-type: none"> ○ 1 channel wiring, with automatic start. ○ 2 channel wiring, with start button.
	<ul style="list-style-type: none"> • Emergency stop monitoring without time delay: <ul style="list-style-type: none"> ○ 1 channel wiring, with automatic start. ○ 2 channel wiring, with start button.
	<ul style="list-style-type: none"> • Two-hand control.
	<ul style="list-style-type: none"> • Guard monitoring: <ul style="list-style-type: none"> ○ with 1 limit switch. ○ with 2 limit switches. ○ with 2 limit switches, with guard locking. • Guard monitoring for injection presses and blowing machines.
	<ul style="list-style-type: none"> • Magnetic switch monitoring.
	<ul style="list-style-type: none"> • Sensing mat monitoring.
	<ul style="list-style-type: none"> • Light curtains monitoring: <ul style="list-style-type: none"> ○ Relay output type. ○ Solid-state output type. • "Muting" function for light curtains.
	<ul style="list-style-type: none"> • Zero speed detection.
	<ul style="list-style-type: none"> • Dynamic monitoring of hydraulic valves on linear presses.

	<ul style="list-style-type: none"> • Safety time delays.
	<ul style="list-style-type: none"> • Monitoring safety stop at top dead centre on eccentric press. • Hydraulic press. • Eccentric press.
	<ul style="list-style-type: none"> • Enabling switching monitoring: <ul style="list-style-type: none"> ◦ 2 contact type. ◦ 3 contact type.

Other functions:

- Foot switch monitoring
- Chain shaft breakage monitoring
- Position selector