

## Three Phase Bridge (Power Modules), 25/35 A



D-63

### FEATURES

- Universal, 3 way terminals: push-on, wrap around or solder
- High thermal conductivity package, electrically insulated case
- Center hole fixing
- Excellent power/volume ratio
- UL E300359 approved
- Gold plated terminals solderable using lead (Pb)-free solder; solder alloy Sn/Ag/Cu (SAC305); solder temperature 260 to 275 °C
- RoHS compliant
- Designed and qualified for industrial and consumer level

**RoHS  
COMPLIANT**

### PRODUCT SUMMARY

$I_o$	25/35 A
-------	---------

### DESCRIPTION

A range of extremely compact, encapsulated three phase bridge rectifiers offering efficient and reliable operation. They are intended for use in general purpose and instrumentation applications.

### MAJOR RATINGS AND CHARACTERISTICS

SYMBOL	CHARACTERISTICS	26MT	36MT	UNITS
$I_o$		25	35	A
	$T_c$	70	60	°C
$I_{FSM}$	50 Hz	360	475	A
	60 Hz	375	500	
$I^2t$	50 Hz	635	1130	A <sup>2</sup> s
	60 Hz	580	1030	
$V_{RRM}$		100 to 1600		V
$T_J$		- 55 to 150		°C

### ELECTRICAL SPECIFICATIONS

#### VOLTAGE RATINGS

TYPE NUMBER	VOLTAGE CODE	$V_{RRM}$ , MAXIMUM REPETITIVE PEAK REVERSE VOLTAGE V	$V_{RSM}$ , MAXIMUM NON-REPETITIVE PEAK REVERSE VOLTAGE V	$I_{RRM}$ MAXIMUM AT $T_J$ MAXIMUM mA
26MT../36MT..	10	100	150	2
	20	200	275	
	40	400	500	
	60	600	725	
	80	800	900	
	100	1000	1100	
	120	1200	1300	
	140	1400	1500	
	160	1600	1700	

FORWARD CONDUCTION							
PARAMETER	SYMBOL	TEST CONDITIONS		VALUES		UNITS	
				26MT	36MT		
Maximum DC output current at $T_C$	$I_O$	120° rect. conduction angle		25	35	A	
				70	60	°C	
Maximum peak, one-cycle non-repetitive forward current	$I_{FSM}$	t = 10 ms	No voltage reapplied	Initial $T_J = T_J$ maximum	360	475	A
		t = 8.3 ms			375	500	
		t = 10 ms	100 % $V_{RRM}$ reapplied		300	400	
		t = 8.3 ms			314	420	
Maximum $I^2t$ for fusing	$I^2t$	t = 10 ms	No voltage reapplied		635	1130	A <sup>2</sup> s
		t = 8.3 ms			580	1030	
		t = 10 ms	100 % $V_{RRM}$ reapplied		450	800	
		t = 8.3 ms			410	730	
Maximum $I^2\sqrt{t}$ for fusing	$I^2\sqrt{t}$	$I^2t$ for time $t_x = I^2\sqrt{t} \times \sqrt{t_x}$ ; $0.1 \leq t_x \leq 10$ ms, $V_{RRM} = 0$ V		6360	11 300	A <sup>2</sup> √s	
Low level of threshold voltage	$V_{F(TO)1}$	$(16.7\% \times \pi \times I_{F(AV)} < I < \pi \times I_{F(AV)})$ , $T_J$ maximum		0.88	0.86	V	
High level of threshold voltage	$V_{F(TO)2}$	$(I > \pi \times I_{F(AV)})$ , $T_J$ maximum		1.13	1.03		
Low level forward slope resistance	$r_{t1}$	$(16.7\% \times \pi \times I_{F(AV)} < I < \pi \times I_{F(AV)})$ , $T_J$ maximum		7.9	6.3	mΩ	
High level forward slope resistance	$r_{t2}$	$(I > \pi \times I_{F(AV)})$ , $T_J$ maximum		5.2	5.0		
Maximum forward voltage drop	$V_{FM}$	$T_J = 25$ °C, $I_{FM} = 40$ Apk - per single junction		1.26	1.19	V	
Maximum DC reverse current	$I_{RRM}$	$T_J = 25$ °C, per junction at rated $V_{RRM}$		100		μA	
RMS isolation voltage	$V_{INS}$	$T_J = 25$ °C, all terminal shorted; $f = 50$ Hz, $t = 1$ s		2700		V	

THERMAL - MECHANICAL SPECIFICATIONS						
PARAMETER	SYMBOL	TEST CONDITIONS		VALUES		UNITS
				26MT	36MT	
Maximum junction and storage temperature range	$T_J, T_{Stg}$			- 55 to 150		°C
Maximum thermal resistance, junction to case	$R_{thJC}$	DC operation per bridge (based on total power loss of bridge)		1.42	1.35	K/W
Maximum thermal resistance, case to heatsink	$R_{thCS}$	Mounting surface, smooth, flat and greased		0.2	0.2	
Approximate weight				20		g
Mounting torque ± 10 %		Bridge to heatsink with screw M4		2.0		Nm



Three Phase Bridge  
(Power Modules), 25/35 A

Vishay High Power Products

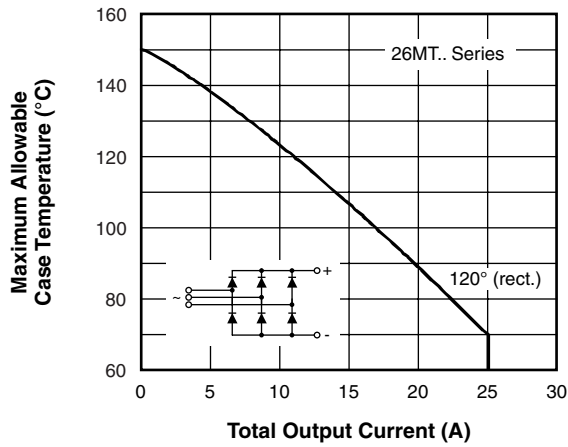

Fig. 1 - Current Ratings Characteristics

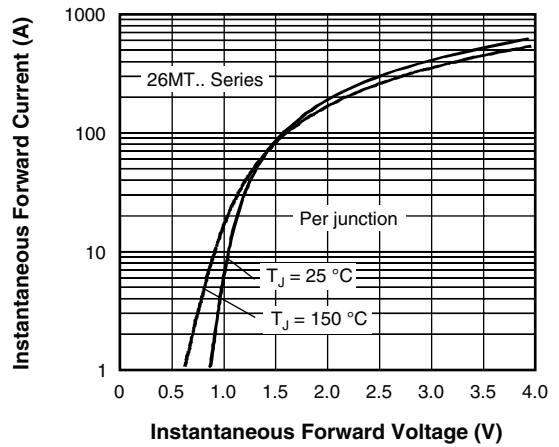

Fig. 2 - Forward Voltage Drop Characteristics

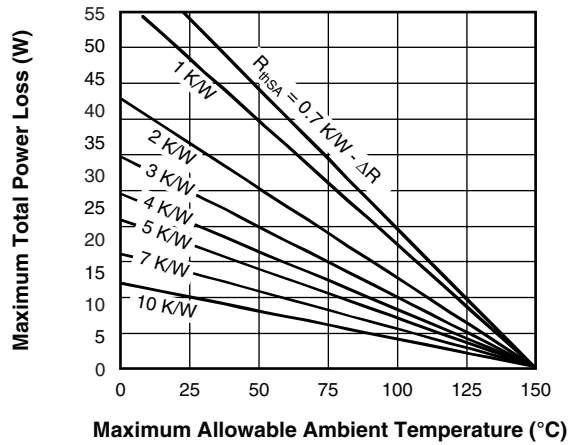
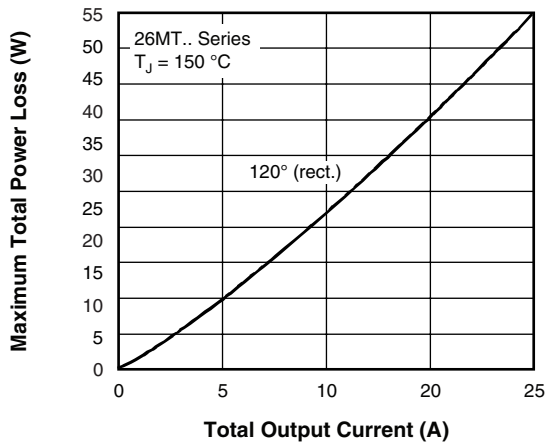

Fig. 3 - Total Power Loss Characteristics

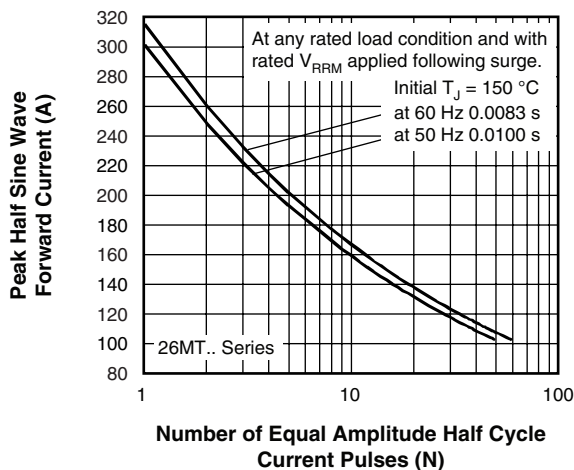

Fig. 4 - Maximum Non-Repetitive Surge Current

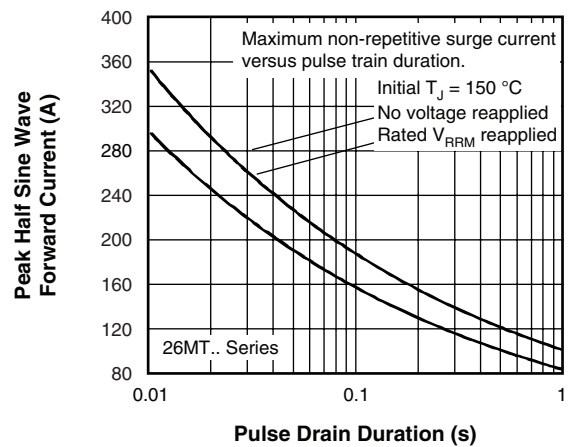

Fig. 5 - Maximum Non-Repetitive Surge Current

# 26MT../36MT.. Series



Vishay High Power Products Three Phase Bridge  
(Power Modules), 25/35 A



Fig. 6 - Current Ratings Characteristics

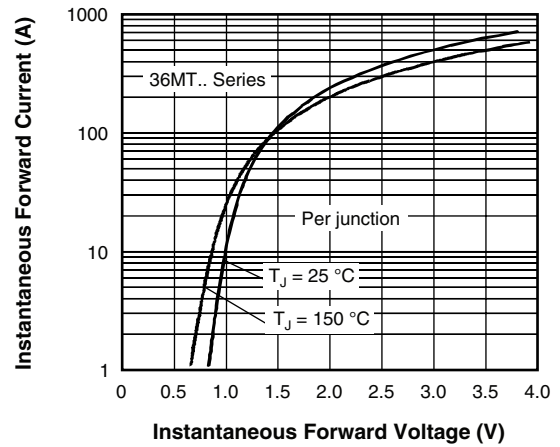

Fig. 7 - Forward Voltage Drop Characteristics

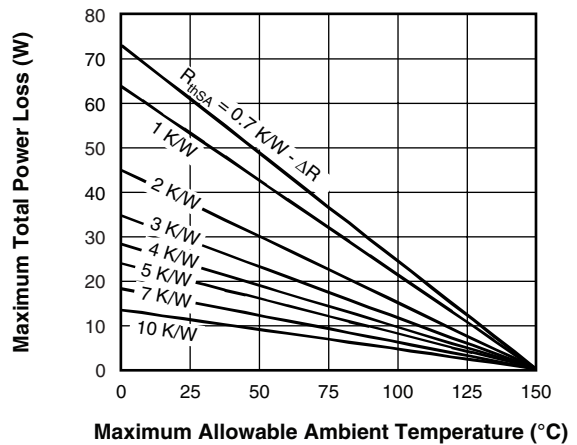

Fig. 8 - Total Power Loss Characteristics



Fig. 9 - Maximum Non-Repetitive Surge Current

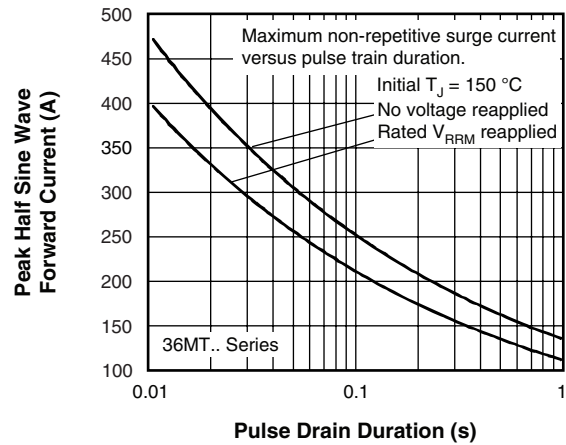

Fig. 10 - Maximum Non-Repetitive Surge Current

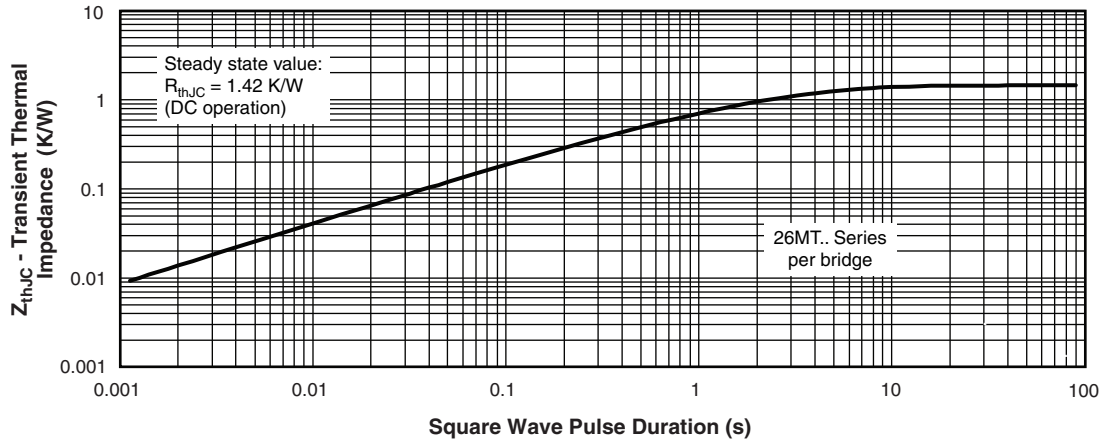

Fig. 11 - Thermal Impedance  $Z_{thJC}$  Characteristics

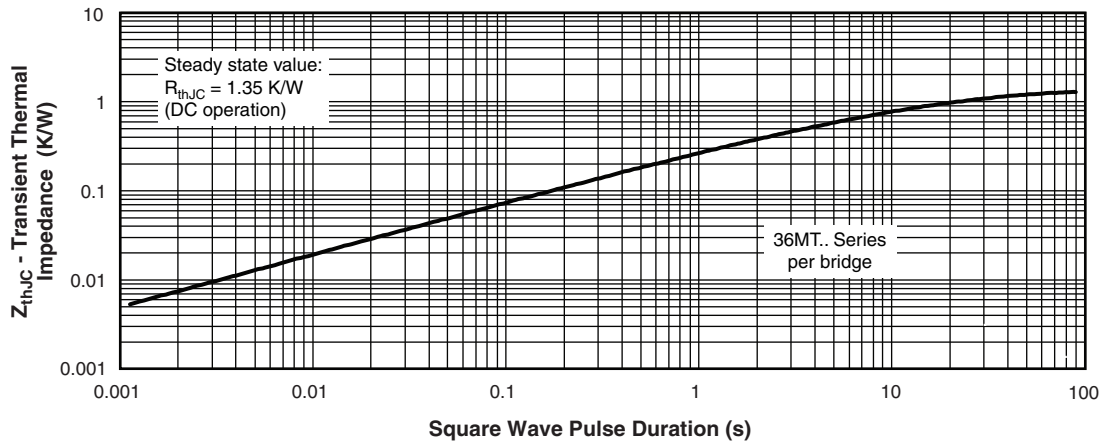
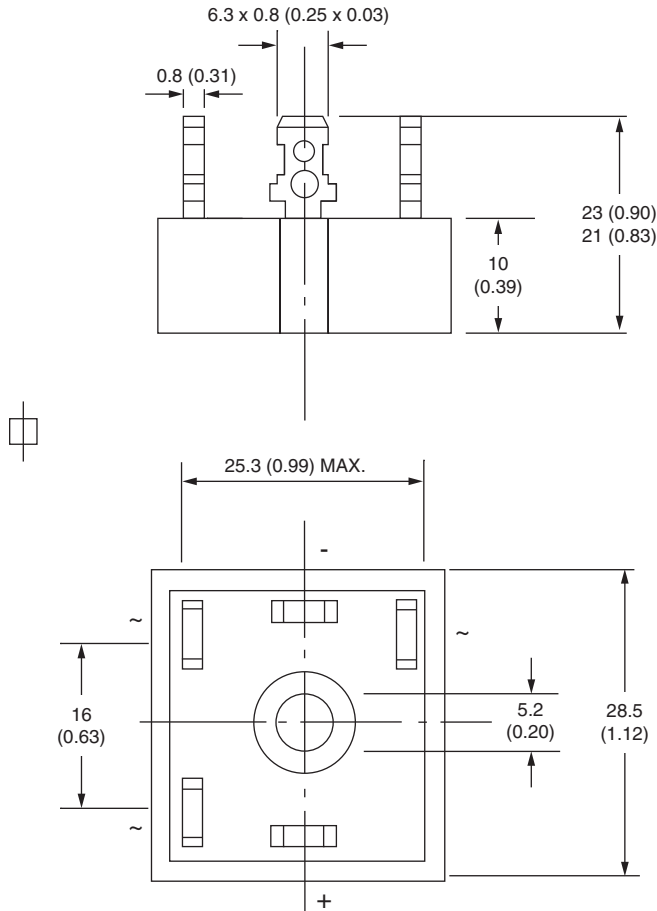

Fig. 12 - Thermal Impedance  $Z_{thJC}$  Characteristics



## D-63

**DIMENSIONS** in millimeters (inches)



Suggested plugging force:  
400 N maximum;  
axially applied to fast on terminals

Not to scale



## Disclaimer

ALL PRODUCT, PRODUCT SPECIFICATIONS AND DATA ARE SUBJECT TO CHANGE WITHOUT NOTICE TO IMPROVE RELIABILITY, FUNCTION OR DESIGN OR OTHERWISE.

Vishay Intertechnology, Inc., its affiliates, agents, and employees, and all persons acting on its or their behalf (collectively, "Vishay"), disclaim any and all liability for any errors, inaccuracies or incompleteness contained in any datasheet or in any other disclosure relating to any product.

Vishay makes no warranty, representation or guarantee regarding the suitability of the products for any particular purpose or the continuing production of any product. To the maximum extent permitted by applicable law, Vishay disclaims (i) any and all liability arising out of the application or use of any product, (ii) any and all liability, including without limitation special, consequential or incidental damages, and (iii) any and all implied warranties, including warranties of fitness for particular purpose, non-infringement and merchantability.

Statements regarding the suitability of products for certain types of applications are based on Vishay's knowledge of typical requirements that are often placed on Vishay products in generic applications. Such statements are not binding statements about the suitability of products for a particular application. It is the customer's responsibility to validate that a particular product with the properties described in the product specification is suitable for use in a particular application. Parameters provided in datasheets and/or specifications may vary in different applications and performance may vary over time. All operating parameters, including typical parameters, must be validated for each customer application by the customer's technical experts. Product specifications do not expand or otherwise modify Vishay's terms and conditions of purchase, including but not limited to the warranty expressed therein.

Except as expressly indicated in writing, Vishay products are not designed for use in medical, life-saving, or life-sustaining applications or for any other application in which the failure of the Vishay product could result in personal injury or death. Customers using or selling Vishay products not expressly indicated for use in such applications do so at their own risk. Please contact authorized Vishay personnel to obtain written terms and conditions regarding products designed for such applications.

No license, express or implied, by estoppel or otherwise, to any intellectual property rights is granted by this document or by any conduct of Vishay. Product names and markings noted herein may be trademarks of their respective owners.

## Material Category Policy

**Vishay Intertechnology, Inc. hereby certifies that all its products that are identified as RoHS-Compliant fulfill the definitions and restrictions defined under Directive 2011/65/EU of The European Parliament and of the Council of June 8, 2011 on the restriction of the use of certain hazardous substances in electrical and electronic equipment (EEE) - recast, unless otherwise specified as non-compliant.**

**Please note that some Vishay documentation may still make reference to RoHS Directive 2002/95/EC. We confirm that all the products identified as being compliant to Directive 2002/95/EC conform to Directive 2011/65/EU.**

**Vishay Intertechnology, Inc. hereby certifies that all its products that are identified as Halogen-Free follow Halogen-Free requirements as per JEDEC JS709A standards. Please note that some Vishay documentation may still make reference to the IEC 61249-2-21 definition. We confirm that all the products identified as being compliant to IEC 61249-2-21 conform to JEDEC JS709A standards.**