

New

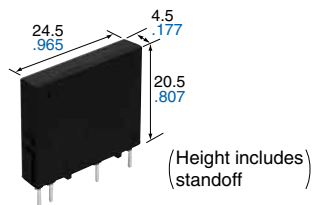

mm inch

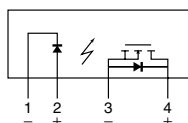

RoHS compliant

FEATURES

1. High capacity type power PhotoMOS.

Can switch a wide range of currents and voltages. Can control various types of loads, from very small loads to a max. 10 A DC current for sequencers, motors, and lamps.

2. Low on-resistance and high sensitivity.

Low on-resistance of less than typ. 8 mΩ (AQZ192). High sensitivity LED operate current of typ. 0.7 mA.

3. 4-pin SIL type

(L) 24.5 mm × (W) 4.5 mm × (H) 20.5 mm
(L) .965 inch × (W) .177 inch × (H) .807 inch.

4. Low-level off state leakage current of max. 10 μA

5. Controls low-level analog signals

The triac, photocoupler, or SSR cannot be used to control signals of less than several hundred mV. The high capacity type power PhotoMOS feature extremely low closed-circuit offset voltage to enable control of low-level analog signals without distortion.

TYPICAL APPLICATIONS

- Photovoltaic power generation system
- Battery system
- Measuring instruments
- Power supply unit
- Industrial machines

* For the latest information on compliance with international standards, please visit our website.

TYPES

	Output rating**		Package	Part No.	Packing quantity	
	Load voltage	Load current			Inner carton	Outer carton
DC only	60 V	10 A	SIL4-pin	AQZ192	20 pcs	500 pcs

Note: Please refer to the cautions for use regarding the recommended operation load voltage.

**Load voltage and load current of DC type: DC

RATING

1. Absolute maximum ratings (Ambient temperature: 25°C 77°F)

Item	Symbol	AQZ192	Remarks	
Input	LED forward current	I _F	50 mA	
	LED reverse voltage	V _R	5 V	
	Peak forward current	I _{FP}	1 A	f = 100Hz, Duty factor = 0.1%
	Power dissipation	P _{in}	75 mW	
Output	Load voltage (DC)	V _L	60 V	
	Continuous load current (DC)	I _L	10 A	
	Peak load current	I _{peak}	30 A	100 ms (1shot), V _L = DC
	Power dissipation	P _{out}	2.0 W	
Total power dissipation	P _T	2.0 W		
I/O isolation voltage	V _{iso}	3,000 V AC		
Temperature limits	Operating	T _{opr}	-40°C to +85°C -40°F to 185°F	Non-condensing at low temperatures
	Storage	T _{stg}	-40°C to +100°C -40°F to 212°F	

Power 1 Form A DC High Capacity (AQZ192)

2. Electrical characteristics (Ambient temperature: 25°C 77°F)

Item			Symbol	AQZ192	Remarks	
Input	LED operate current	Typical	I _{Fon}	0.7 mA	I _L = 100 mA V _L = 10 V	
		Maximum		3.0 mA		
	LED turn off current	Minimum	I _{Foff}	0.2 mA		
		Typical		0.5 mA		
	LED dropout voltage	Typical	V _F	1.35 V (1.17 V at I _F = 10 mA)		I _F = 50 mA
Maximum		1.5 V				
Output	On resistance	Typical	R _{on}	8 mΩ	I _F = 10 mA, I _L = max. Within 1 s on time	
		Maximum		15 mΩ		
	Off state leakage current	Maximum	I _{Leak}	10 μA		I _F = 0 mA, V _L = max.
Transfer characteristics	Turn on time*	Typical	T _{on}	1.0 ms	I _F = 10 mA, I _L = 100 mA, V _L = 10 V	
		Maximum		3.0 ms		
	Turn off time*	Typical	T _{off}	0.11 ms		I _F = 10 mA I _L = 100 mA, V _L = 10 V
		Maximum		1.0 ms		
	I/O capacitance	Typical	C _{iso}	1.7 pF		f = 1 MHz V _B = 0 V
		Maximum		3.0 pF		
	Initial I/O isolation resistance	Minimum	R _{iso}	1,000 MΩ		500 V DC
Maximum operating frequency	Maximum	—	0.5 cps	I _F = 10 mA, Duty factor = 50% V _L × I _L = 600 V·A		

Note: Please refer to the "Schematic and Wiring Diagrams" for connection method.

*Turn on/off time

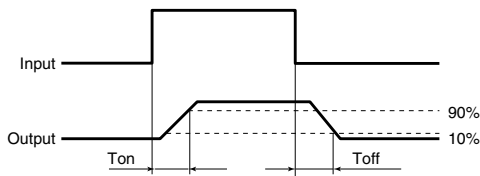

RECOMMENDED OPERATING CONDITIONS

Please obey the following conditions to ensure proper device operation and resetting.

Item	Symbol	Recommended value	Unit
Input LED current	I _F	10	mA

■ For Dimensions.

■ For Schematic and Wiring Diagrams.

■ For Cautions for Use.

■ These products are not designed for automotive use.

If you are considering to use these products for automotive applications, please contact your local Panasonic Corporation technical representative.

For more information, please refer to the "PhotoMOS® Automation Controls Group Catalog".

REFERENCE DATA

1. Load current vs. ambient temperature characteristics

Allowable ambient temperature: -40°C to +85°C
-40°F to +185°F

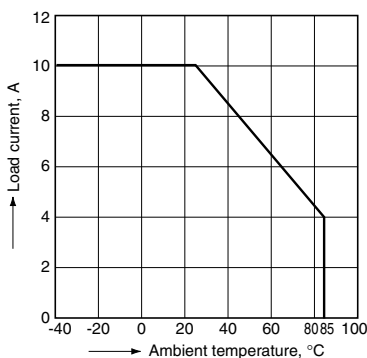

2. Load current vs. ambient temperature characteristics in adjacent mounting

I_L: Load current;
I_L (max.): Maximum continuous load current

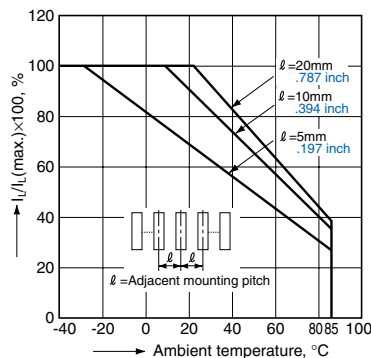

3. On resistance vs. ambient temperature characteristics

LED current: 10 mA; Load voltage: Max. (DC)
Continuous load current: Max. (DC)

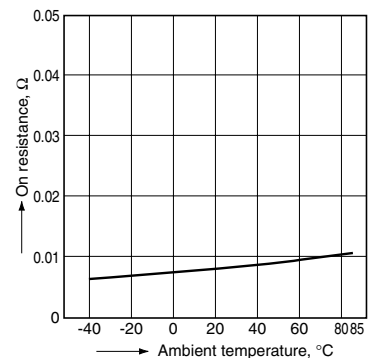

Power 1 Form A DC High Capacity (AQZ192)

4. Turn on time vs. ambient temperature characteristics

LED current: 10 mA; Load voltage: 10 V (DC);
Continuous load current: 100 mA (DC)

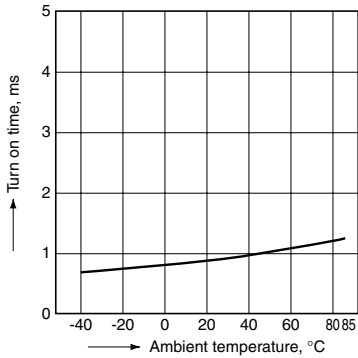

5. Turn off time vs. ambient temperature characteristics

LED current: 10 mA; Load voltage: 10 V (DC);
Continuous load current: 100 mA (DC)

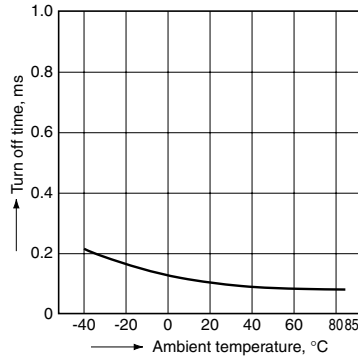

6. LED operate current vs. ambient temperature characteristics

Load voltage: 10 V (DC);
Continuous load current: 100 mA (DC)

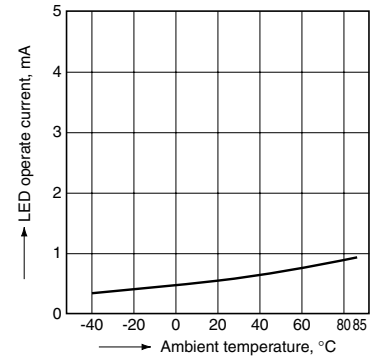

7. LED turn off current vs. ambient temperature characteristics

Load voltage: 10 V (DC);
Continuous load current: 100 mA (DC)

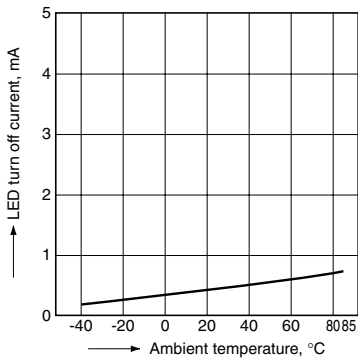

8. LED dropout voltage vs. ambient temperature characteristics

LED current: 5 to 50 mA

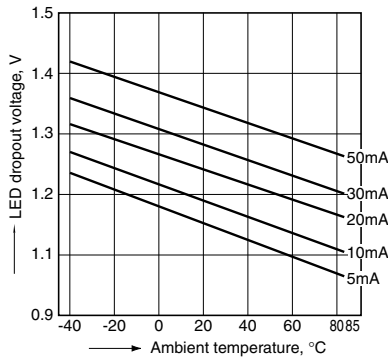

9. Current vs. voltage characteristics of output at MOS portion

Ambient temperature: 25°C 77°F

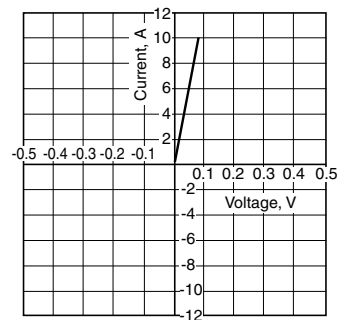

10. Off state leakage current vs. load voltage characteristics

Ambient temperature: 25°C 77°F

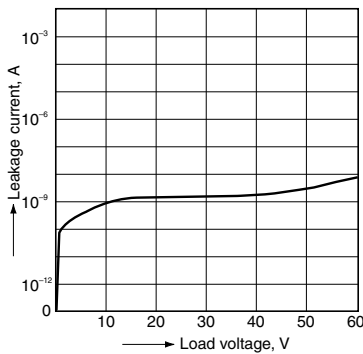

11. Turn on time vs. LED forward current characteristics

Load voltage: 10 V (DC); Continuous load current:
100 mA (DC); Ambient temperature: 25°C 77°F

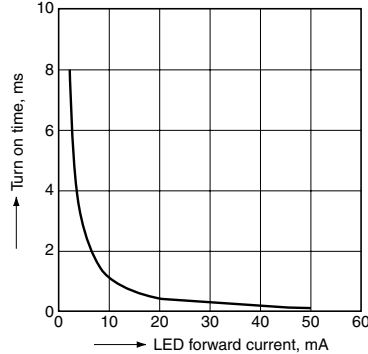

12. Turn off time vs. LED forward current characteristics

Load voltage: 10 V (DC); Continuous load current:
100 mA (DC); Ambient temperature: 25°C 77°F

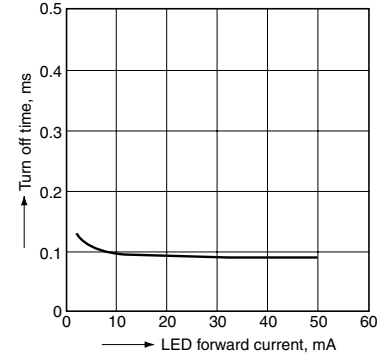

13. Maximum operating frequency vs. load voltage/current characteristics

LED current: 10 mA; Ambient temperature: 25°C 77°F

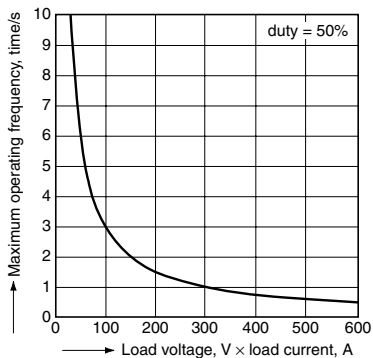

14. Output capacitance vs. applied voltage characteristics

Frequency: 1 MHz; Ambient temperature: 25°C 77°F

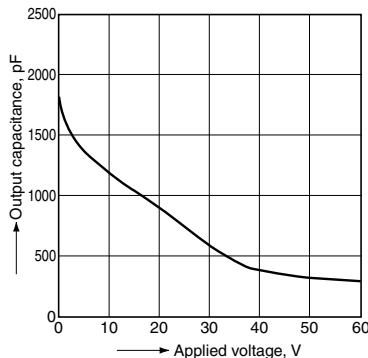

Power 1 Form A DC High Capacity (AQZ192)

DIMENSIONS (mm inch)

The CAD data of the products with a **CAD Data** mark can be downloaded from: <http://industrial.panasonic.com/ac/e/>

CAD Data

External dimensions

PC board pattern (Bottom view)

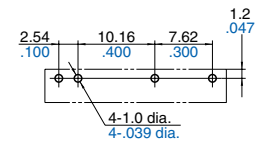
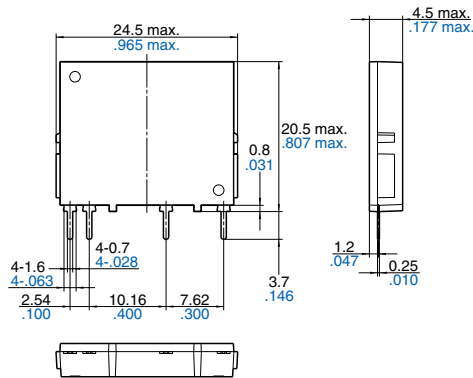

Tolerance: $\pm 0.1 \pm 0.004$

Schematic

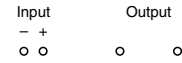

General tolerance: $\pm 0.2 \pm 0.008$

SCHEMATIC AND WIRING DIAGRAMS

E_i : Power source at input side, I_F : LED forward current, V_L : Load voltage, I_L : Load current

Schematic	Output configuration	Load	Wiring diagram
	1 Form A	DC	

PhotoMOS® Cautions for Use

SAFETY WARNINGS

• Do not use the product under conditions that exceed the range of its specifications. It may cause overheating, smoke, or fire.

• Do not touch the recharging unit while the power is on. There is a danger of electrical shock. Be sure to turn off the power when performing mounting, maintenance, or repair operations on the device (including connecting parts such as the terminal board and socket).

• Check the connection diagrams in the catalog and be sure to connect the terminals correctly. Erroneous connections could lead to unexpected operating errors, overheating, or fire.

1. Applying stress that exceeds the absolute maximum rating

If the voltage or current value for any of the terminals exceeds the absolute maximum rating, internal elements will deteriorate because of the overvoltage or overcurrent. In extreme cases, wiring may melt, or silicon P/N junctions may be destroyed.

Therefore, the circuit should be designed in such a way that the load never exceed the absolute maximum ratings, even momentarily.

2. Derating design

Derating is essential in any reliable design and is a significant factor for product life.

Even if the conditions of use (temperature, current, voltage, etc.) of the product fall within the absolute maximum ratings, reliability can be reduced

remarkably when continually used under high load (high temperature, high humidity, high current, high voltage, etc.). Therefore, please derate sufficiently below the absolute maximum rating and verify operation of the actual design before use.

Also, if there is the possibility that the inferior quality of this product could possibly cause great adverse affect on human life or physical property we recommend that, from the perspective of a manufacturer's liability, sufficient amount of derating to be added to the maximum rating value and implement safety measures such as fail-safe circuit.

3. Short across terminals

Do not short circuit between terminals when device is energized, since there is possibility of breaking of the internal IC.

4. Surge voltages at the input

If reverse surge voltages are present at the input terminals, connect a diode in reverse parallel across the input terminals and keep the reverse voltages below the reverse breakdown voltage.

Power type

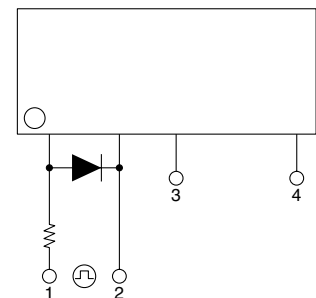

5. LED current vs. ambient temperature characteristics

Please keep the LED current to within the range given below.

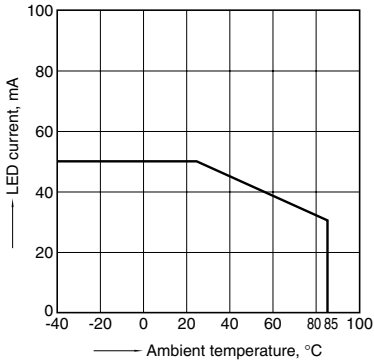

6. Ripple in the input power supply

If ripple is present in the input power supply, observe the following:

- 1) For LED current at E_{min} , please maintain 5 to 10 mA.
- 2) Please make sure for E_{max} is no higher the LED current at than 50 mA.

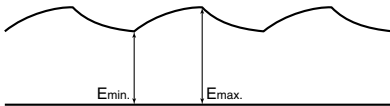

7. Output spike voltages

- 1) If an inductive load generates spike voltages which exceed the absolute maximum rating, the spike voltage must be limited.

Power type

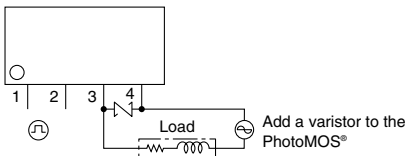
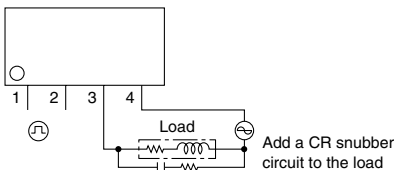
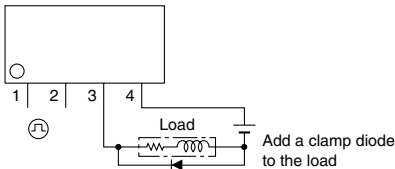

- 2) Even if spike voltages generated at the load are limited with a clamp diode if the circuit wires are long, spike voltages will occur by inductance. Keep wires as short as possible to minimize inductance.

8. Cleaning solvents compatibility

We recommend cleaning with an organic solvent. If you cannot avoid using ultrasonic cleansing, please ensure that the following conditions are met, and check beforehand for defects.

- Frequency: 27 to 29 kHz
- Ultrasonic output: No greater than 0.25W/cm² (Note)
- Cleaning time: No longer than 30 s
- Cleanser used: Asahiklin AK-225
- Other: Submerge in solvent in order to prevent the PCB and elements from being contacted directly by the ultrasonic vibrations.

Note: Applies to unit area ultrasonic output for ultrasonic baths.

9. Notes for mounting

- 1) If many different packages are combined on a single substrate, then lead temperature rise is highly dependent on package size. For this reason, please make sure that the temperature of the terminal solder area of the PhotoMOS® falls within the temperature conditions of item 10 before mounting.
- 2) If the mounting conditions exceed the recommended solder conditions in item 10, resin strength will fall and the nonconformity of the heat expansion coefficient of each constituent material will increase markedly, possibly causing cracks in the package, severed bonding wires, and the like. For this reason, please inquire with us about whether this use is possible.

10. Soldering

When soldering PC board terminals, keep soldering time to within 10 s at 260°C 500°F.

- When using lead-free solder, we recommend a type with an alloy composition of Sn 3.0 Ag 0.5 Cu. Please inquire about soldering conditions and other details.

11. Packing format

Tube packing

Devices are packaged in a tube so that pin No. 1 is on the stopper B side. Observe correct orientation when mounting them on PC boards.

(Power type)

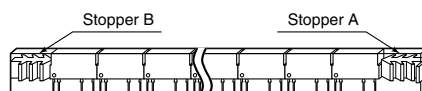

12. Transportation and storage

- 1) Extreme vibration during transport will warp the lead or damage the device. Handle the outer and inner boxes with care.
- 2) Storage under extreme conditions will cause soldering degradation, external appearance defects, and deterioration of the characteristics. The following storage conditions are recommended:
 - Temperature: 0 to 45°C 32 to 113°F
 - Humidity: Less than 70% R.H.
 - Atmosphere: No harmful gasses such as sulfurous acid gas, minimal dust.

13. Input LED current (Power standard type)

For rising and dropping ratio of input LED current (di/dt), maintain min. 100 μA/s.

14. Adjacent mounting (Power type)

- 1) When devices are mounted close together with the heat-generated devices, ambient temperature may rise abnormally. Mounting layout and ventilation should be considered.
- 2) When many devices are mounted close together, load current should be reduced. (Refer to the date of "Load current vs. ambient temperature characteristics in adjacent mounting.")

15. Recommended load voltage

As a guide in selecting PhotoMOS®, please refer to the following table.

Part No.	Absolute maximum rating		Recommended load voltage
	Load voltage	Load current	
AQZ192	60 V DC	10 A DC	5, 12, 24 V DC

Please contact

Panasonic Corporation

Automation Controls Business Unit

■ Head Office: 1048, Kadoma, Kadoma-shi, Osaka 571-8686, Japan

■ Telephone: +81-6-6908-1050 ■ Facsimile: +81-6-6908-5781

industrial.panasonic.com/ac/e/

Panasonic®

© Panasonic Corporation 2012