

HFBR-RXXYYYYZ Series (POF) HFBR-EXXYYYYZ Series (POF) HFBR-CXXYYYYZ Series (POF)

Plastic Optical Fiber Cable and Accessories
for Versatile Link



Data Sheet



Cable Description

The HFBR-C/R/EXXYYYYZ series of plastic fiber optic cables are constructed of a single step-index fiber sheathed in a black polyethylene jacket. The duplex fiber consists of two simplex fibers joined with a zipcord web.

Standard (Type="R") and Extra Low Loss (Type="E") cables comply with UL VW-1 flame retardant specification (UL file # E89328) except for Commercial (Type="C")

Cables are available in unconnected or connected options. Refer to the Ordering Guide for part number information.

Features

- Compatible with Avago Versatile Link Family of connectors and fiber optic components
- 1 mm diameter Plastic Optical Fiber (POF) in 3 grades:
 - Commercial POF with 0.22dB/m typical attenuation (0°C to 70°C)
 - Standard POF with 0.22 dB/m typical attenuation (-40°C to 85°C)
 - High performance Extra Low Loss POF with 0.19 dB/m typical attenuation (-40°C to 85°C).

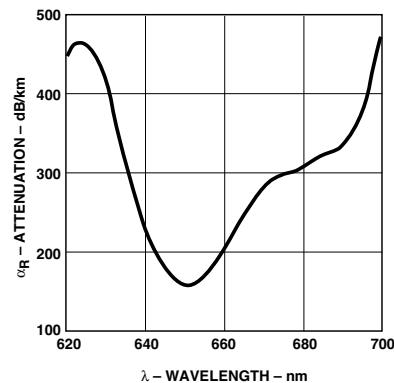

Figure 1. Typical POF attenuation vs. wavelength.

Applications

- Industrial data links for factory automation and plant control
- Intra-system links; board-to-board, rack-to-rack
- Telecommunications switching systems
- Computer-to-peripheral data links, PC bus extension
- Proprietary LANs
- Digitized video
- Medical instruments
- Reduction of lightning and voltage transient susceptibility
- High voltage isolation

Plastic Optical Fiber Specifications: HFBR-C/R/EXXYYYYZ

Absolute Maximum Ratings

Parameter		Symbol	Min.	Max.	Unit	Note
Recommended Storage Temperature	(HFBR-R/EXXYYYYZ)	T _s	-55	+85	°C	
	(HFBR-CXXYYYYZ)	T _s	-40	+70	°C	
Recommended Operating Temperature	(HFBR-R/EXXYYYYZ)	T _o	-40	+85	°C	
	(HFBR-CXXYYYYZ)	T _o	0	+70	°C	
Recommended Installation Temperature	(HFBR-R/EXXYYYYZ)	T _i	-20	+70	°C	1
	(HFBR-CXXYYYYZ)	T _i	0	+70	°C	
Short Term Tensile Force	Single Channel	F _T		50	N	2
	Dual Channel	F _T		100	N	
Short Term Bend Radius		r	25		mm	3, 4
Long Term Bend Radius		r	35		mm	
Long Term Tensile Load		F _T		1	N	
Flexing				1000	Cycles	4, 8

UL VW-1 Flame Retardant

Mechanical/Optical Characteristics, T_A = -40 to +85°C unless otherwise specified.

Parameter		Symbol	Min.	Typ. ^[5]	Max.	Unit	Condition
Cable Attenuation Source: 660nm LED, 0.5 NA (HFBR-15xxZ) Length:50m	Commercial Cable, Type "C"	α _O	0.15	0.22	0.27	dB/m	T _A =-0°C to +70°C
	Standard Cable, Type="R"		0.15	0.22	0.27		T _A =-40°C to +85°C
	Extra Low Loss, Type="E"		0.15	0.19	0.23		T _A =-40°C to +85°C
Reference Attenuation Source: 650nm, 0.5 NA (monochrometer) Length:50m	Commercial Cable, Type "C"	α _R	0.12	0.19	0.24	dB/m	T _A =-0°C to +70°C
	Standard Cable, Type="R"		0.12	0.19	0.24		T _A =-40°C to +85°C
	Extra Low Loss, Type="E"		0.12	0.16	0.19		T _A =-40°C to +85°C
Numerical Aperture		NA	0.46	0.47	0.50		>2 meters
Diameter, Core and Cladding		DC	0.94	1.00	1.06	mm	
Diameter, Jacket		DJ	2.13	2.20	2.27	mm	Simplex Cable
Propagation Delay Constant		l/v		5.0		ns/m	Note 6
Mass per Unit Length/Channel				5.3		g/m	Without Connectors
Cable Leakage Current		IL		12		nA	50 kV, l = 0.3 meters
Refractive Index	Core	n		1.492			
	Cladding			1.417			

Notes:

1. Installation temperature is the range over which the cable can be bent and pulled without damage. Below -20°C the cable becomes brittle and should not be subjected to mechanical stress.
2. Short Term Tensile Force is for less than 30 minutes.
3. Short Term Bend Radius is for less than 1 hour nonoperating.
4. 90° bend on 25 mm radius mandrel. Bend radius is the radius of the mandrel around which the cable is bent.
5. Typical data are at 25°C.
6. Propagation delay constant is the reciprocal of the group velocity for propagation delay of optical power. Group velocity is v=c/n where c is the velocity of light in free space (3x10⁸ m/s) and n is the effective core index of refraction.
7. Note that α_R rises at the rate of about 0.0067 dB/°C, where the thermal rise refers to the LED temperature changes above 25°C. Please refer to Figure 1 which shows the typical plastic optical fiber attenuation versus wavelength at 25°C.
8. Not available for Commercial (Type="C") cable

Plastic Fiber Connector Styles

Connector Description

Four connector styles are available for termination of plastic optical fiber: simplex, simplex latching, duplex and duplex latching. All connectors provide a snap-in action when mated to Versatile Link components. Simplex connectors are color coded to facilitate identification of transmitter and receiver connections. Duplex connectors are keyed so that proper orientation is ensured during insertion. If the POF cable/connector will be used at extreme operating temperatures or experience frequent and wide temperature cycling effects, the cable/connector attachment can be strengthened with an RTV adhesive (see Plastic Connecting Instructions for more detail). The connectors are made of a flame retardant VALOX UL94 V-0 material (UL file # E121562).

SIMPLEX CONNECTOR STYLES

HFBR-4501Z/4511Z – Simplex



SIMPLEX CRIMP RING, HFBR-4525Z

The simplex connector provides a quick and stable connection for applications that require a component-to-connector retention force of 8 Newtons (1.8 lb.). These connectors are available in gray (HFBR-4501Z) or blue (HFBR-4511Z). The simplex connector is compatible with horizontal or vertical or tilted packages.

HFBR-4503Z/4513Z – Simplex Latching



The simplex latching connector is designed for rugged applications requiring a greater retention force — 80 Newtons (18 lb.) — than provided by a simplex non-latching connector. When inserting the simplex latching connector into a module, the connector latch mechanism should be aligned with the top surface of the horizontal package, or with the tall vertical side of the vertical package or with top surface of tilted package. Misalignment of an inserted latching connector into either module will not result in a positive latch. The connector is released by depressing the rear section of the connector lever, and then pulling the connector assembly away from the module housing.

The simplex latching connector is available in gray (HFBR-4503Z) or blue (HFBR-4513Z).

DUPLEX CONNECTOR STYLES

HFBR-4506Z – Duplex

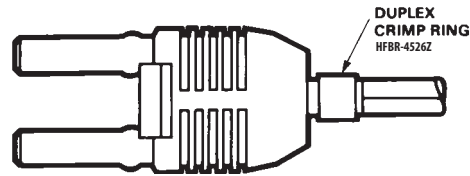

Duplex connectors provide convenient duplex cable termination and are keyed to prevent incorrect insertion into duplex configured modules. The duplex connector is compatible with dual combinations of horizontal, vertical or tilted packages (e.g., two horizontal transmitters, two vertical receivers, a horizontal transmitter with a horizontal receiver, etc.). The duplex non-latching connector is available in parchment, off-white (HFBR-4506Z).

HFBR-4516Z – Duplex Latching

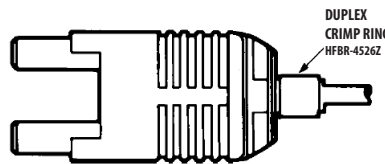

The duplex latching connector is designed for rugged applications requiring greater retention force than the nonlatching duplex connector. When inserting the duplex latching connector into a module, the connector latch mechanism should be aligned with the top surface of the dual combination of horizontal, vertical or tilted packages. The duplex latching connector is available in gray (HFBR-4516Z).

Feedthrough/Splice

HFBR-4505Z/4515Z Bulkhead Adapter

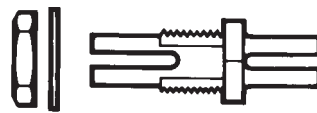

The HFBR-4505Z/4515Z adapter mates two simplex connectors for panel/bulkhead feedthrough of HFBR-4501Z/4511Z terminated plastic fiber cable. Maximum panel thickness is 4.1 mm (0.16 inch). This adapter can serve as a cable in-line splice using two simplex connectors. The adapters are available in gray (HFBR-4505Z) and blue (HFBR-4515Z). This adapter is not compatible with POF duplex, POF simplex latching, or HCS connectors.

Plastic Optical Fiber Connector Absolute Maximum Ratings

Parameter	Symbol	Min.	Max.	Unit	Note
Storage and Operating Temperature	$T_{S,O}$	-40	85	°C	1
Recommended Operating Temperature	T_O	-40	85	°C	1
Installation Temperature	T_I	0	70	°C	1
Nut Torque	T_N		0.7	N-m	2
HFBR-4505Z/4515Z Adapter			100	OzF-in.	

Notes:

- Storage and Operating Temperatures refer to the ranges over which the connectors can be used when not subjected to mechanical stress. Installation Temperature refers to the ranges over which connectors may be installed onto the fiber and over which connectors can be connected and disconnected from transmitter and receiver modules.
- Recommended nut torque is 0.57 N-m.

Plastic Optical Fiber Connector Mechanical/Optical Characteristics

$T_A = -40$ to $+85^\circ\text{C}$, Unless Otherwise Specified.

Parameter	Part Number	Symbol	Min.	Typ. ^[1]	Max.	Units	Temp. °C	Note
Retention Force, Connector to Versatile Link Transmitters and Receivers	Simplex, HFBR-4501Z/4511Z	F_{R-C}	7	8		N	+25	2
			3				-40 to +85	
	Simplex Latching, HFBR-4503Z/4513Z	47	80		+25			
		11			-40 to +85			
Tensile Force, Connector to Cable	Simplex, HFBR-4501Z/4511Z	F_T	8.5	22		N		3
			8.5	22				
	Simplex Latching, HFBR-4503Z/4513Z	14	35					
		14	35					
Adapter Connector to Connector Loss	HFBR-4505Z/4515Z with HFBR-4501Z/4511Z	α_{CC}	0.7	1.5	2.8	dB	25	4, 5
Retention Force Connector to Adapter	HFBR-4505Z/4515Z with HFBR-4501Z/4511Z	F_{R-B}	7	8		N		
Insertion Force, Connector to Versatile Link Transmitters and Receivers	Simplex, HFBR-4501Z/4511Z	F_I		8	30	N		6
				16	35			
	Simplex Latching, HFBR-4503Z/4513Z		13	46				
		Duplex, HFBR-4506Z		22	51			
	Duplex Latching HFBR-4516Z							

Notes:

- Typical data are at $+25^\circ\text{C}$.
- No perceivable reduction in retention force was observed after 2000 insertions. Retention force of non-latching connectors is lower at elevated temperatures. Latching connectors are recommended for applications where a high retention force at high temperatures is desired.
- For applications where frequent temperature cycling over temperature extremes is expected, please contact Avago Technologies for alternate connecting techniques.
- Minimum and maximum limit for α_{CC} for 0°C to $+70^\circ\text{C}$ temperature range. Typical value of α_{CC} is at $+25^\circ\text{C}$.
- Factory polish or field polish per recommended procedure.
- Destructive insertion force was typically at 178 N (40 lb.).

Step-by-Step Plastic Cable Connecting Instructions

The following step-by-step guide describes how to terminate plastic fiber optic cable. It is ideal for both field and factory installation. Connectors can be easily installed on cable ends with wire strippers, cutters and a crimping tool.

Finishing the cable is accomplished with the Avago HFBR-4594Z Polishing Kit, consisting of a Polishing Fixture, 600 grit abrasive paper and 3 µm pink lapping film (3M Company, OC3-14). The connector can be used immediately after polishing.

Materials needed for plastic fiber termination are:

1. Avago Plastic Optical Fiber Cable (Example: HFBR-RUS500Z, HFBR-RUD500Z, HFBR-EUS500Z, or HFBR-EUD500Z)
2. Industrial Razor Blade or Wire Cutters
3. 16 Gauge Latching Wire Strippers (Example: Ideal Stripmaster™ type 45-092).
4. HFBR-4597Z Crimping Tool
5. HFBR-4594Z Polishing Kit
6. One of the following connectors:
 - a) HFBR-4501Z/4503Z Gray Simplex/Simplex Latching Connector and HFBR-4525Z Simplex Crimp Ring
 - b) HFBR-4511Z/4513Z Blue Simplex/Simplex Latching Connector and HFBR-4525Z Simplex Crimp Ring
 - c) HFBR-4506Z Parchment (off-white) Duplex Connector and HFBR-4526Z Duplex Crimp Ring
 - d) HFBR-4516Z Gray Latching Duplex Connector and HFBR-4526Z Duplex Crimp Ring

Step 1

The zip cord structure of the duplex cable permits easy separation of the channels. The channels should be separated a minimum of 100 mm (4 in) to a maximum of 150 mm (6 in) back from the ends to permit connecting and polishing.

After cutting the cable to the desired length, strip off approximately 7 mm (0.3 in.) of the outer jacket with the 16 gauge wire strippers. Excess webbing on the duplex cable may have to be trimmed to allow the simplex or simplex latching connector to slide over the cable.

When using the duplex connector and duplex cable, the separated duplex cable must be stripped to equal lengths on each cable. This allows easy and proper seating of the cable into the duplex connector.

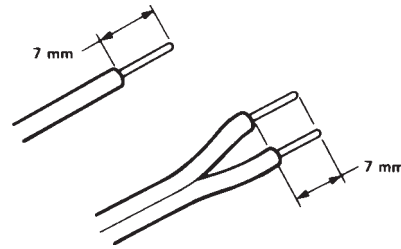

Step 2

Place the crimp ring and connector over the end of the cable; the fiber should protrude about 3 mm (0.12 in.) through the end of the connector. Carefully position the ring so that it is entirely on the connector with the rim of the crimp ring flush with the connector, leaving a small space between the crimp ring and the flange. Then crimp the ring in place with the crimping tool. One crimp tool is used for all POF connector crimping requirements.

For applications with extreme temperature operation or frequent temperature cycling, improved connector to cable attachment can be achieved with the use of an RTV (GE Company, RTV-128 or Dow Corning 3145-RTV) adhesive. The RTV is placed into the connector prior to insertion of the fiber and the fiber is crimped normally. The connector can be polished after the RTV has cured and is then ready for use.

Note: By convention, place the gray connector on the transmitter cable end and the blue connector on the receiver cable end to maintain color coding (different color connectors are mechanically identical).

Simplex connector crimp rings cannot be used with duplex connectors and duplex connector crimp rings cannot be used with simplex connectors because of size differences. The simplex crimp has a dull luster appearance; the duplex ring is glossy and has a thinner wall.

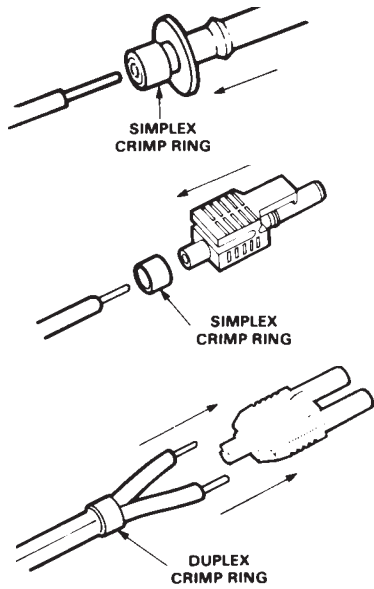

Step 3

Any excess fiber protruding from the connector end may be cut off; however, the trimmed fiber should extend at least 1.5 mm (0.06 in) from the connector end.

Insert the connector fully into the polishing fixture with the trimmed fiber protruding from the bottom of the fixture. This plastic polishing fixture can be used to polish two simplex connectors or simplex latching connectors simultaneously, or one duplex connector.

Note: The four dots on the bottom of the polishing fixture are wear indicators. Replace the polishing fixture when any dot is no longer visible. Typically, the polishing fixture can be used 10 times; 10 duplex connectors or 20 simplex connectors, two at a time.

Place the 600 grit abrasive paper on a flat smooth surface, pressing down on the connector, polish the fiber and the connector using a figure eight pattern of strokes until the connector is flush with the bottom of the polishing fixture. Wipe the connector and fixture with a clean cloth or tissue.

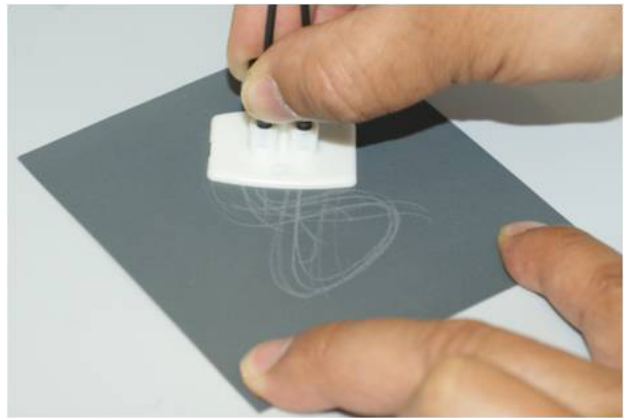
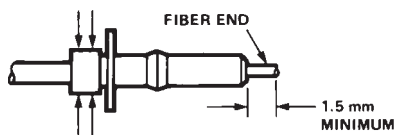

Step 4

Place the flush connector and polishing fixture on the dull side of the 3 μ m pink lapping film and continue to polish the fiber and connector for approximately 25 strokes. The fiber end should be flat, smooth and clean.

This cable is now ready for use.

Note: Use of the pink lapping film fine polishing step results in approximately 2 dB improvement in coupling performance of either a transmitter-receiver link or a bulkhead/splice over a 600 grit polish alone. This fine polish is comparable to the Avago factory polish. The fine polishing step may be omitted where an extra 2 dB of optical power is not essential, as with short link lengths. Proper polishing of the tip of the fiber/connector face results in a tip diameter between 2.5 mm (0.098 in.) minimum and 3.2 mm (0.126 in.) maximum..

HFBR-4594Z Polishing Kit

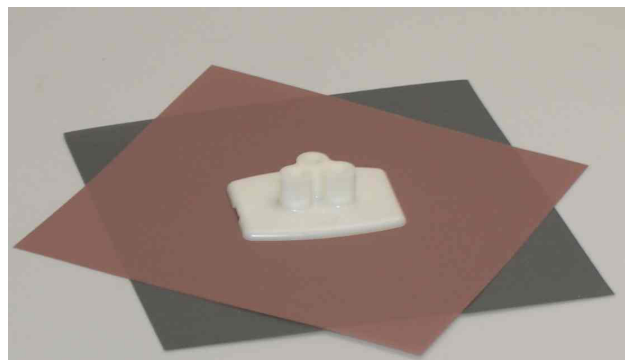

Ordering Guide for POF Connectors and Accessories

Plastic Optical Fiber Connectors

HFBR-4501Z	Gray Simplex Connector/Crimp Ring
HFBR-4511Z	Blue Simplex Connector/Crimp Ring
HFBR-4503Z	Gray Simplex Latching Connector with Crimp Ring
HFBR-4513Z	Blue Simplex Latching Connector with Crimp Ring
HFBR-4506Z	Parchment Duplex Connector with Crimp Ring
HFBR-4516Z	Gray Duplex Latching Connector with Crimp Ring
HFBR-4505Z	Gray Adapter (Bulkhead/Feedthrough)
HFBR-4515Z	Blue Adapter (Bulkhead/Feedthrough)

Plastic Optical Fiber Accessories

HFBR-4522Z	500 HFBR-0500 Products Port Plugs
HFBR-4525Z	1000 Simplex Crimp Rings
HFBR-4526Z	500 Duplex Crimp Rings
HFBR-4594Z	Polishing Kit (one polishing tool, two pieces 600 grit abrasive paper, and two pieces 3 µm pink lapping film)
HFBR-4597Z	Plastic Fiber Crimping Tool

Ordering Guide for POF Cable

For Example:

HFBR-RUD500Z is a Standard Attenuation, Unconnected, Duplex, 500 meter cable.

HFBR-RLS001Z is a Standard Attenuation, Latching Simplex Connected, Simplex, 1 meter cable.

HFBR-RMD010Z is a Standard Attenuation, Standard Duplex Connected, Duplex, 10 meter cable.

HFBR-RMD100Z is a Standard Attenuation, Standard Duplex Connected, Duplex, 100 meter cable.

Cable Length Tolerances:

The plastic cable length tolerances are: +10%/-0%.

NOTE: By convention, pre-connected simplex POF cables have gray and blue colored connectors on the opposite ends of the same fiber; although oppositely colored, the connectors are mechanically identical. Duplex POF cables with duplex connectors use color-coded markings on the duplex fiber cable to differentiate between the channel.

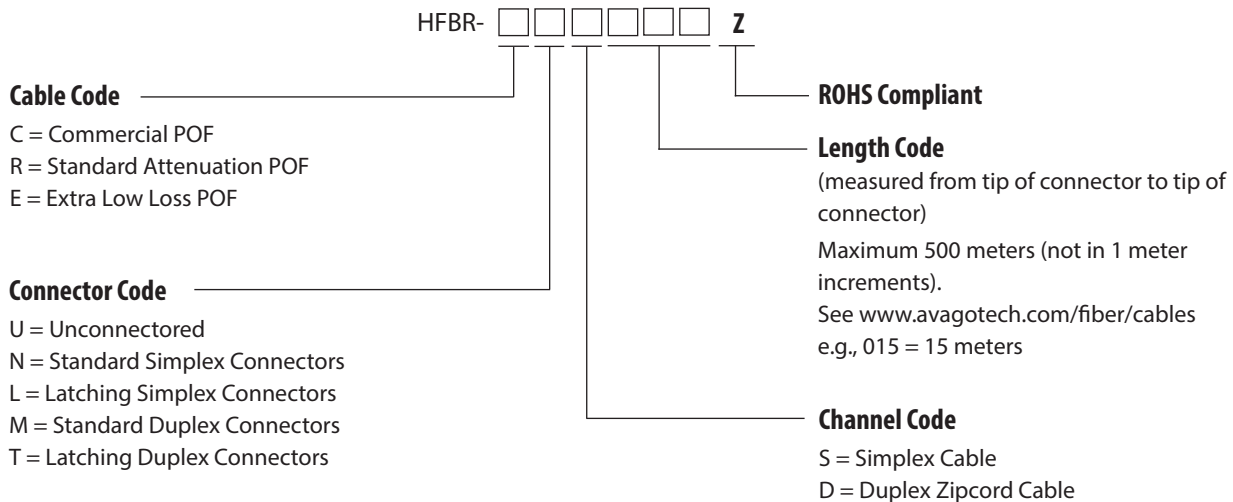

Note: Not all possible combinations reflect available part numbers. Please contact your local Avago representative for a list of current available cable part numbers.

Connector Applications

Attachment to Avago Versatile Link Fiber Optic Components

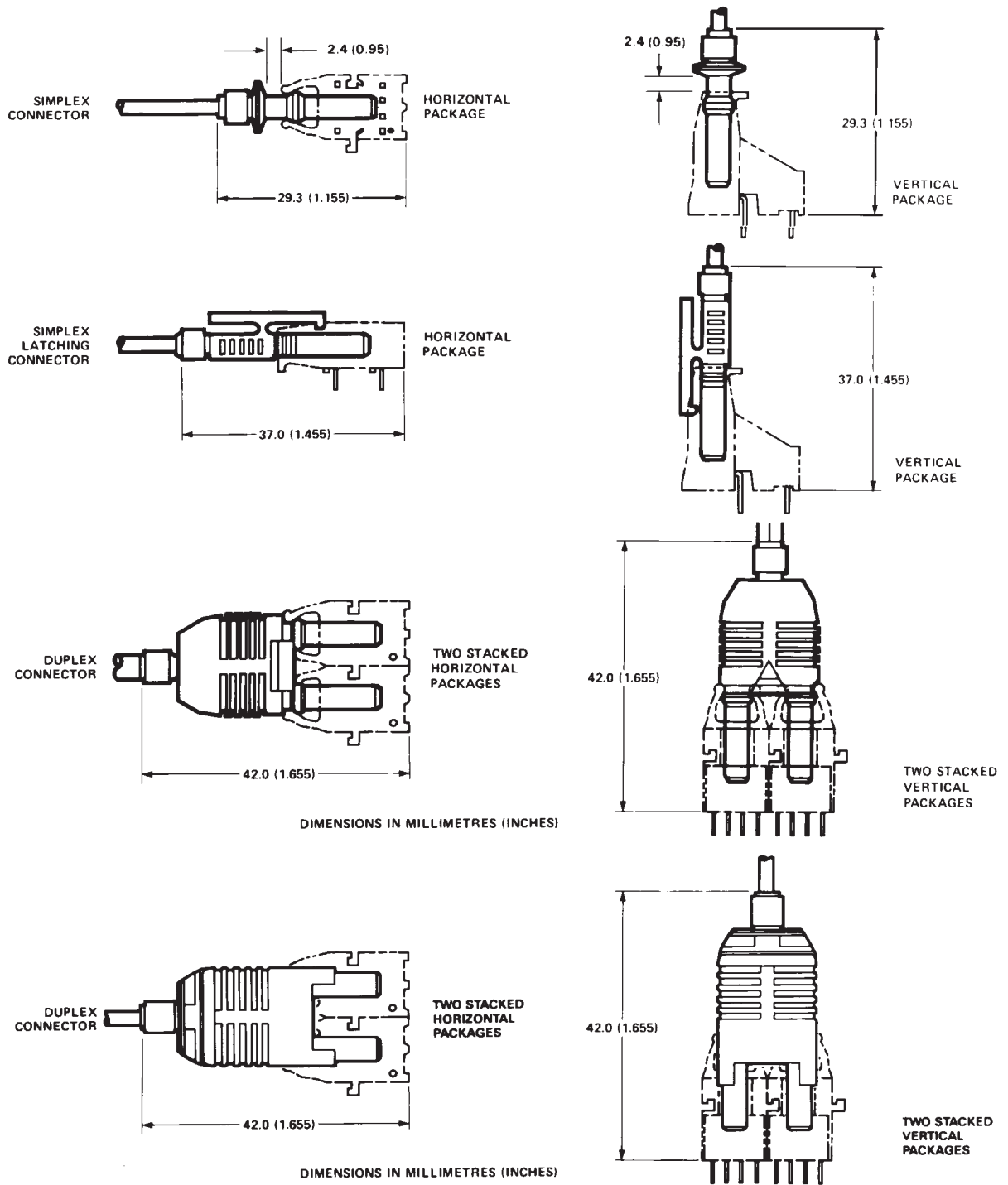

Bulkhead Feedthrough or Panel Mounting for HFBR-4501Z/4511Z Simplex Connectors

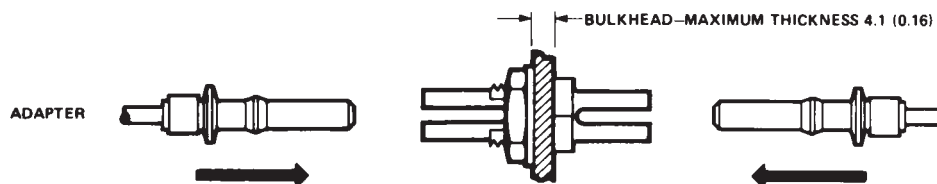

Versatile Link Mechanical Dimensions

Fiber Optic Cable Dimensions

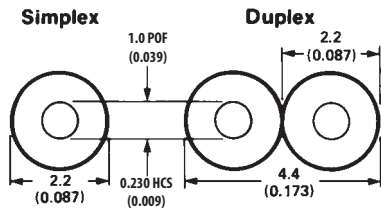

Panel Mounting – Bulkhead Feedthrough

THREE TYPES OF PANEL/BULKHEAD HOLES CAN BE USED.

DIMENSIONS IN mm (INCHES)
ALL DIMENSIONS ± 0.2 mm

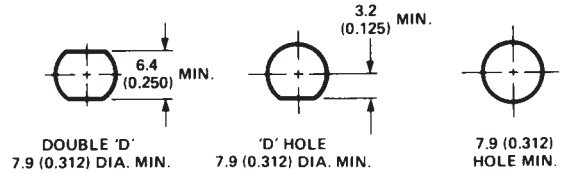

HFBR-4505Z (Gray)/4515Z (Blue) Adapters



Bulkhead Feedthrough with Two HFBR-4501Z/4511Z Connectors

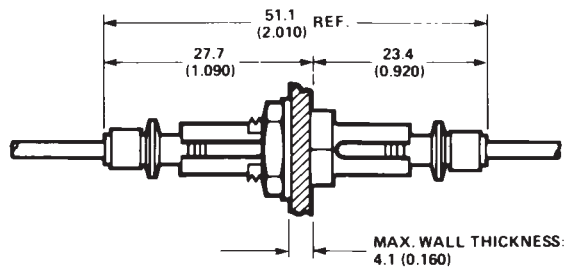

All dimensions in mm (inches).
All dimensions ±0.25 mm unless otherwise specified.

Versatile Link Mechanical Dimensions, continued

HFBR-4516Z (Parchment) Duplex Latching Connector

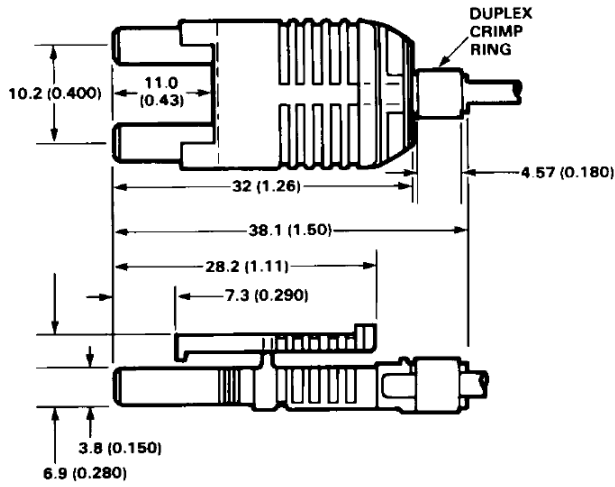

HFBR-4506Z (Parchment) Duplex Connector

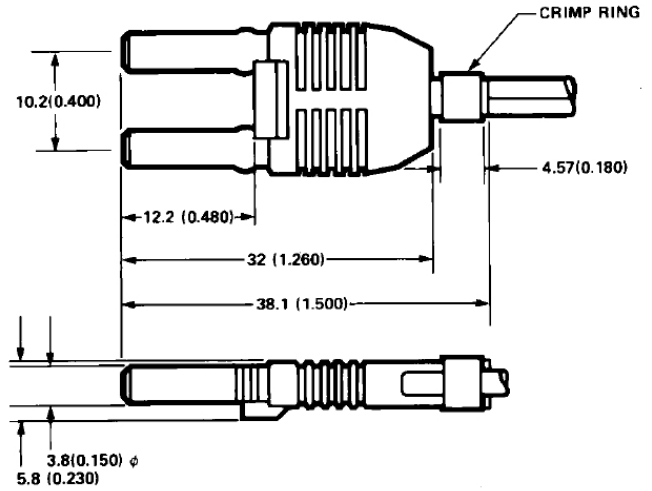

HFBR-4503Z (Gray)/4513Z (Blue) Simplex Latching Connector



HFBR-4501Z (Gray)/4511Z (Blue) Simplex Connector

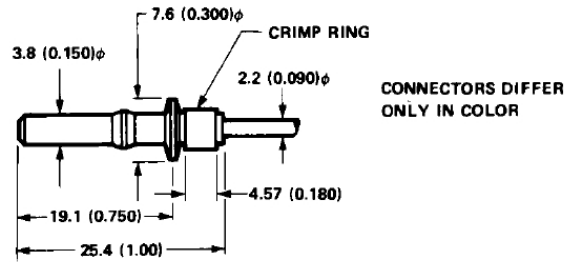

All dimensions in mm (inches).
All dimensions ± 0.25 mm unless otherwise specified.

For product information and a complete list of distributors, please go to our website: www.avagotech.com

Avago, Avago Technologies, and the A logo are trademarks of Avago Technologies in the United States and other countries. Data subject to change. Copyright © 2005-2013 Avago Technologies. All rights reserved. Obsoletes AV01-0150EN AV02-1508EN - December 5, 2013

